



US00D918106S

(12) **United States Design Patent** (10) **Patent No.:** **US D918,106 S**
Mignot et al. (45) **Date of Patent:** **** May 4, 2021**

(54) **STEERING WHEEL WITH DISPLAY SCREEN FOR AN AUTOMOBILE**

(71) Applicants: **Hyundai Motor Company**, Seoul (KR); **Kia Motors Corporation**, Seoul (KR)

(72) Inventors: **Guillermo Mignot**, Ruesselsheim (DE); **Soo Yul Bae**, Seoul (KR); **Donckerwolke Luc**, Seoul (KR)

(73) Assignees: **Hyundai Motor Company**, Seoul (KR); **Kia Motors Corporation**, Seoul (KR)

(**) Term: **15 Years**

(21) Appl. No.: **35/508,566**

(22) Filed: **Aug. 14, 2019**

(80) **Hague Agreement Data**

Int. Filing Date: **Aug. 14, 2019**
Int. Reg. No.: **DM/204230**
Int. Reg. Date: **Aug. 14, 2019**
Int. Reg. Pub. Date: **Feb. 14, 2020**

(51) **LOC (13) Cl.** **12-16**

(52) **U.S. Cl.**
USPC **D12/176**

(58) **Field of Classification Search**
USPC D12/175, 176; D14/414; D21/333
CPC B60R 21/203; B60R 21/05; B62D 1/04
See application file for complete search history.

(56) **References Cited**

U.S. PATENT DOCUMENTS

3,937,101 A * 2/1976 Wade B60N 3/005
74/552
D342,474 S * 12/1993 Oki D12/176
D346,997 S * 5/1994 Kurtis D12/176
D420,708 S * 2/2000 Holmes D21/329

D435,603 S * 12/2000 Holmes D21/329
D743,859 S * 11/2015 Gong D12/176
9,193,375 B2 * 11/2015 Schramm B60K 37/06
9,421,993 B2 * 8/2016 Spaggiari B60Q 1/0082
D769,781 S * 10/2016 Allison D12/175
9,511,790 B2 * 12/2016 Spaggiari B60Q 1/0082
D787,994 S * 5/2017 Carbone D12/175
9,821,726 B2 * 11/2017 Nash G06F 3/0426
D816,567 S * 5/2018 Yoo D12/176
D824,302 S * 7/2018 Cadalora D12/177
D825,418 S * 8/2018 Cadalora D12/177
D826,117 S * 8/2018 Cadalora D12/177
D853,290 S * 7/2019 Helmstetter D12/175
D870,004 S * 12/2019 Hill D12/175
D890,756 S * 7/2020 Wall D14/393
D899,328 S * 10/2020 Roo-Clefas D12/176
2009/0108617 A1 * 4/2009 Songwe, Jr. B60R 11/0264
296/70
2013/0298716 A1 * 11/2013 Salvini B62D 1/105
74/492
2015/0123947 A1 * 5/2015 Jubner B60K 37/06
345/175

(Continued)

Primary Examiner — Darlington Ly

(74) *Attorney, Agent, or Firm* — Mintz Levin Cohn Ferris Glovsky and Popeo, P.C.; Peter F. Corless; Carolina E. Säve

(57) **CLAIM**

The ornamental design for a steering wheel with display screen for an automobile, as shown and described.

DESCRIPTION

1. Steering wheel with display screens for an automobile
1.1 is a perspective view of a steering wheel with display screen for an automobile embodying our new design;
1.2 is a front elevation view thereof;
1.3 is a rear elevation view thereof;
1.4 is a left side elevation view thereof;
1.5 is a right side elevation view thereof;
1.6 is a top plan view thereof; and
1.7 is a bottom plan view thereof.

1 Claim, 7 Drawing Sheets

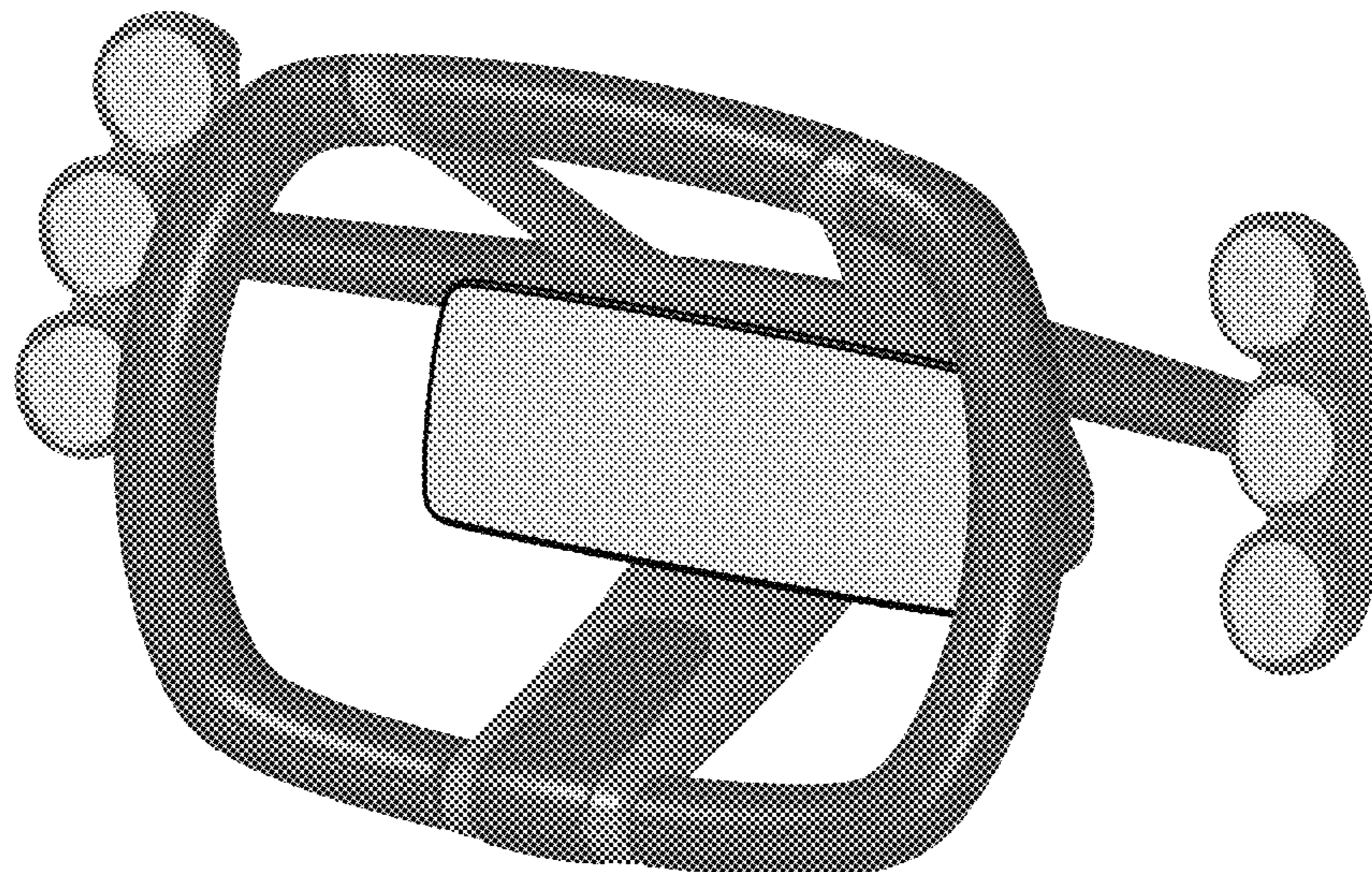

(56)

References Cited

U.S. PATENT DOCUMENTS

2016/0001807 A1* 1/2016 Hans B60R 11/0229
345/173
2016/0375924 A1* 12/2016 Bodtker B60K 35/00
74/552
2017/0253192 A1* 9/2017 Faist G06F 3/0227

* cited by examiner

1.1

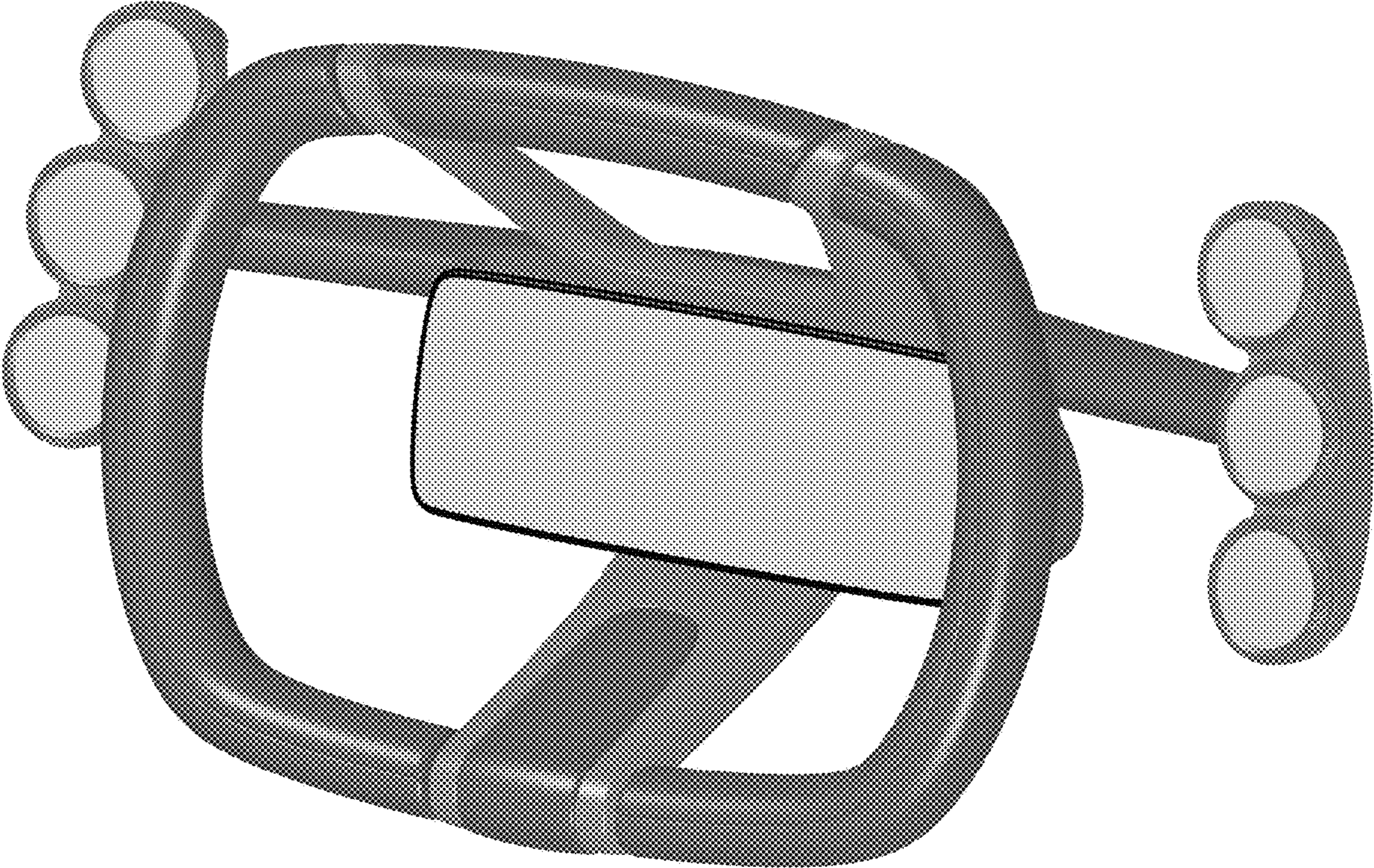

1.2

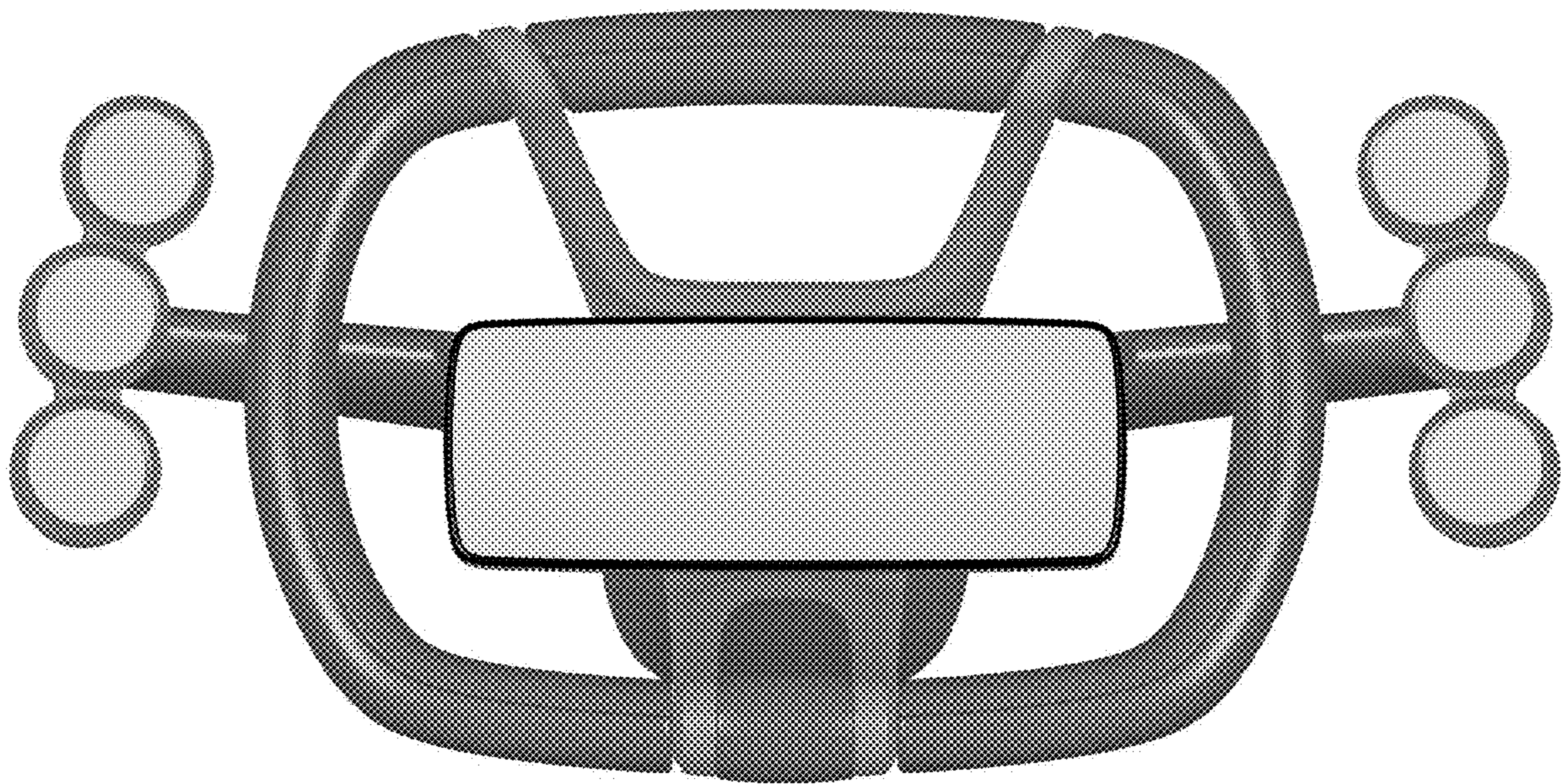

1.3

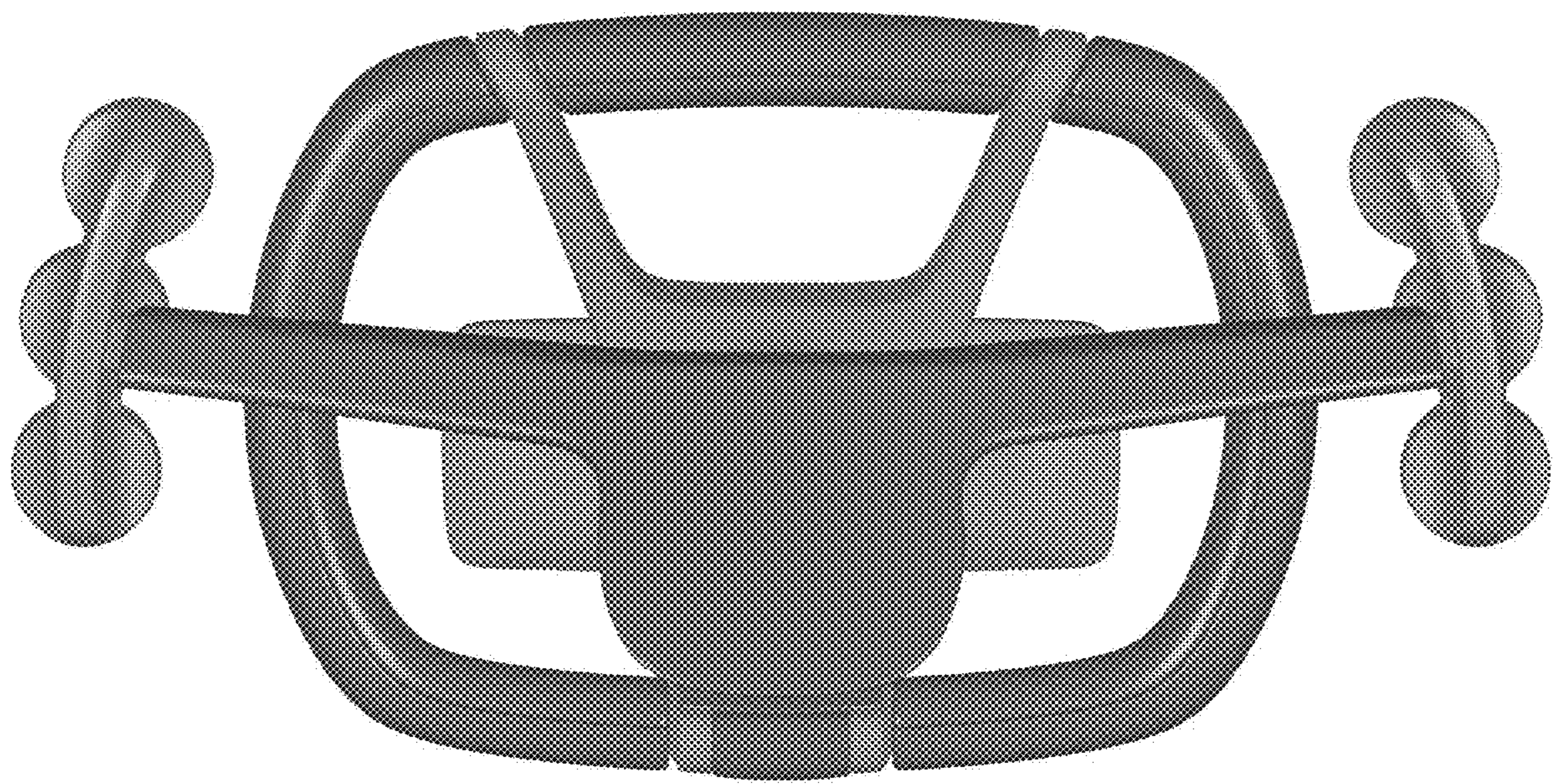

1.4

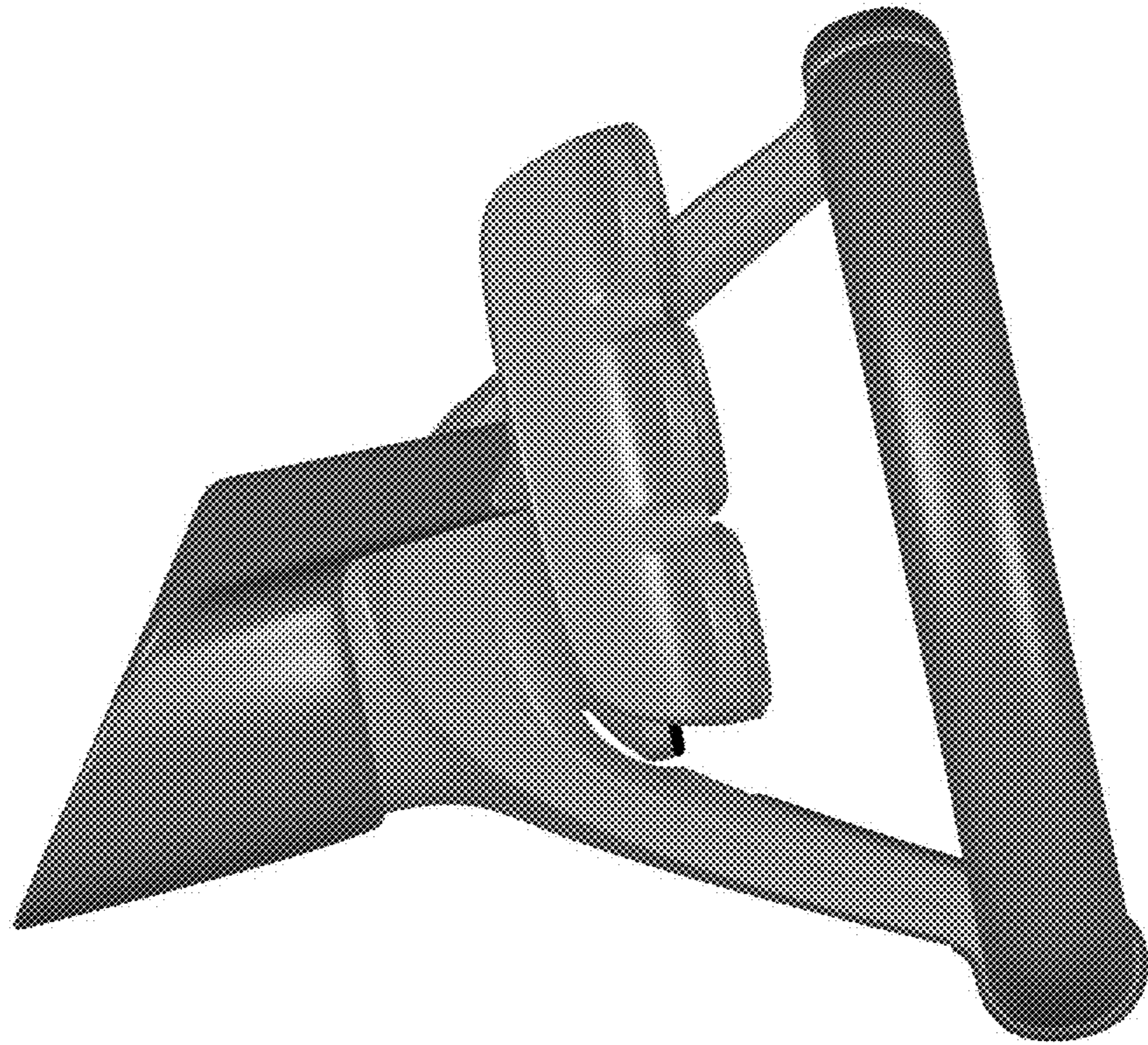

1.5

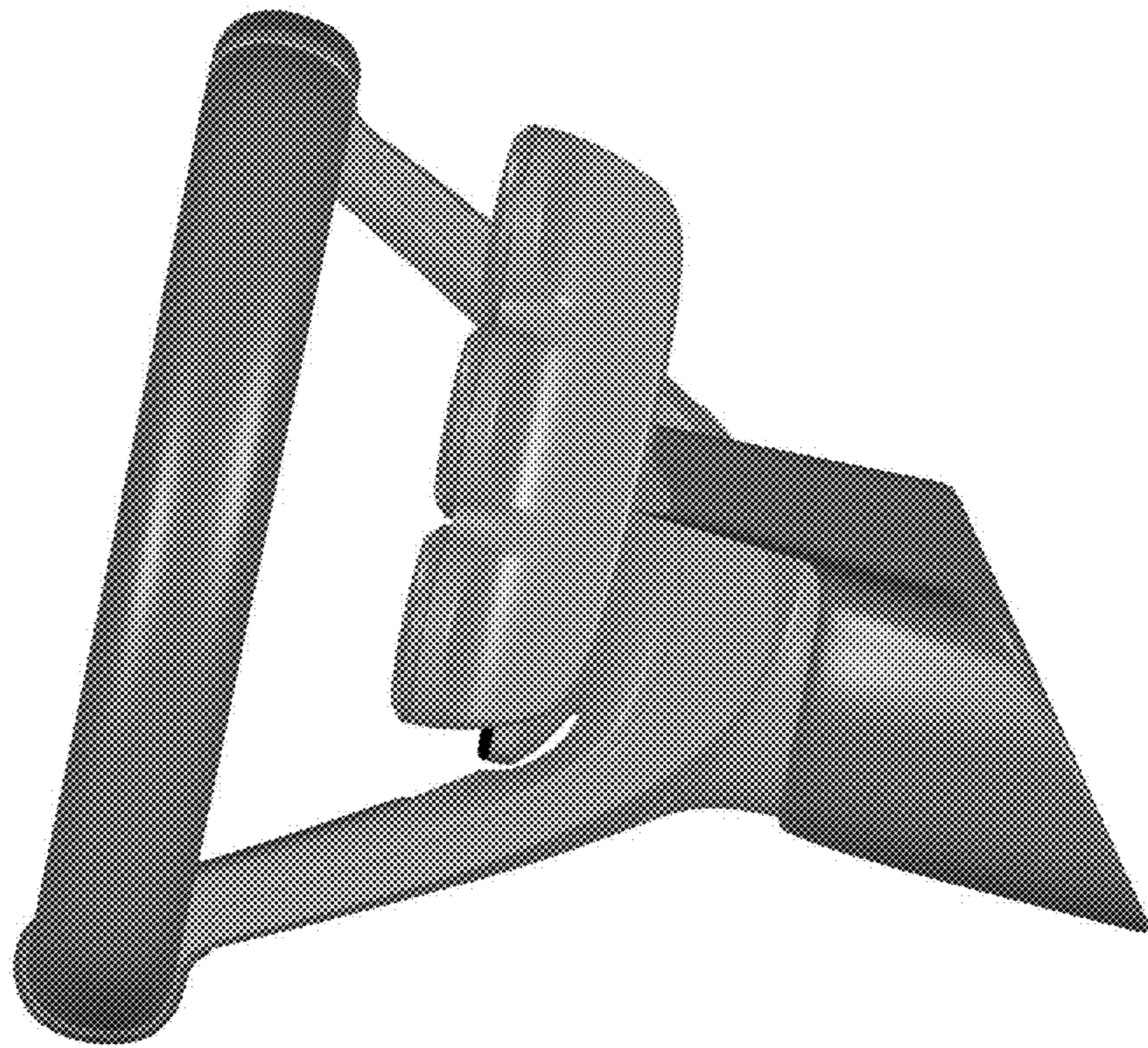

1.6

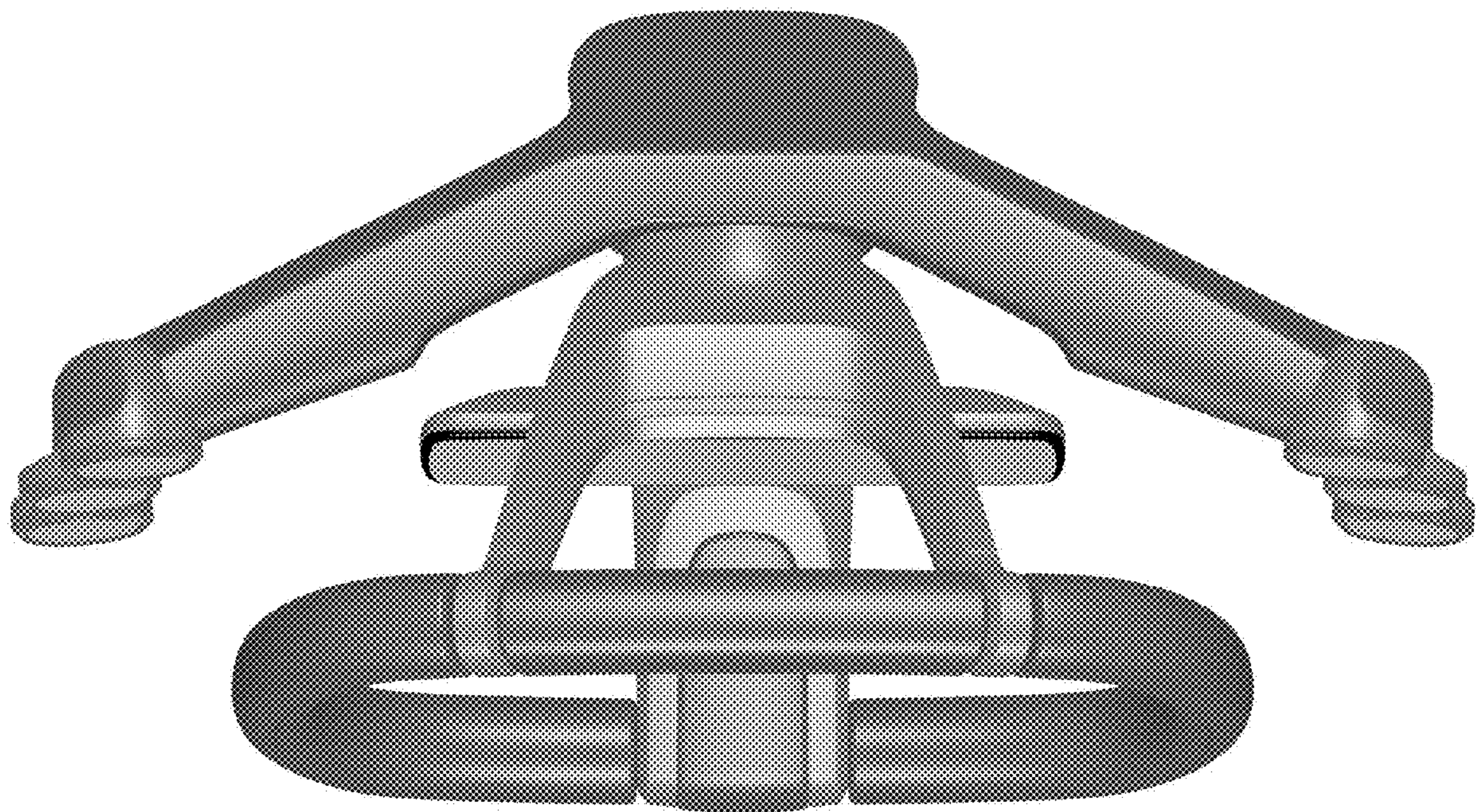

1.7

