



US00D918044S

(12) **United States Design Patent** (10) **Patent No.:** **US D918,044 S**
Caliri (45) **Date of Patent:** **** May 4, 2021**

(54) **CONTAINER**

2016/0056854 A1* 2/2016 Leung H04B 1/3888
455/575.8

(71) Applicant: **John Stephen Caliri**, Prineville, OR
(US)

* cited by examiner

(72) Inventor: **John Stephen Caliri**, Prineville, OR
(US)

Primary Examiner — Janice Patyk

(**) Term: **15 Years**

(57) **CLAIM**

The ornamental design for a container, as shown and described.

(21) Appl. No.: **29/660,552**

DESCRIPTION

(22) Filed: **Aug. 21, 2018**

(51) **LOC (13) Cl.** **09-01**

(52) **U.S. Cl.**
USPC **D9/523**

(58) **Field of Classification Search**
USPC D9/522, 523, 529, 549, 558, 572, 573,
D9/724
CPC B65D 1/02; B65D 1/0223; B65D 1/023;
B65D 1/0261; B65D 2501/0009; B65D
2501/0081; B65D 2501/009
See application file for complete search history.

FIG. 1 is a perspective view of a container, showing my new design;
FIG. 2 is a front view thereof;
FIG. 3 is a back view thereof;
FIG. 4 is a side view thereof;
FIG. 5 is an opposite side view thereof;
FIG. 6 is a top view thereof;
FIG. 7 is a bottom view thereof;
FIG. 8 is a perspective view thereof, shown with the spout in folded condition;
FIG. 9 is a front view thereof, shown with the spout in folded condition;
FIG. 10 is a back view thereof, shown with the spout in folded condition;
FIG. 11 is a side view thereof, shown with the spout in folded condition;
FIG. 12 is an opposite side view thereof, shown with the spout in folded condition;
FIG. 13 is a top view thereof, shown with the spout in folded condition; and,
FIG. 14 is a bottom view thereof, shown with the spout in folded condition.
The broken lines in the figures illustrate the portions of the design that form no part of the claimed design.

(56) **References Cited**

U.S. PATENT DOCUMENTS

- 2,165,277 A * 7/1939 Koch B65D 3/06
229/405
- 6,616,033 B1 * 9/2003 Schein B65D 77/12
229/103.1
- D556,626 S * 12/2007 Shaffer D11/143
- D569,762 S * 5/2008 Nachumzon D11/143
- D754,479 S * 4/2016 Tae D7/512
- 10,336,499 B2 * 7/2019 Wambolt B65D 5/36
- 2004/0187382 A1 * 9/2004 Tsang A47G 7/063
47/41.01

1 Claim, 8 Drawing Sheets

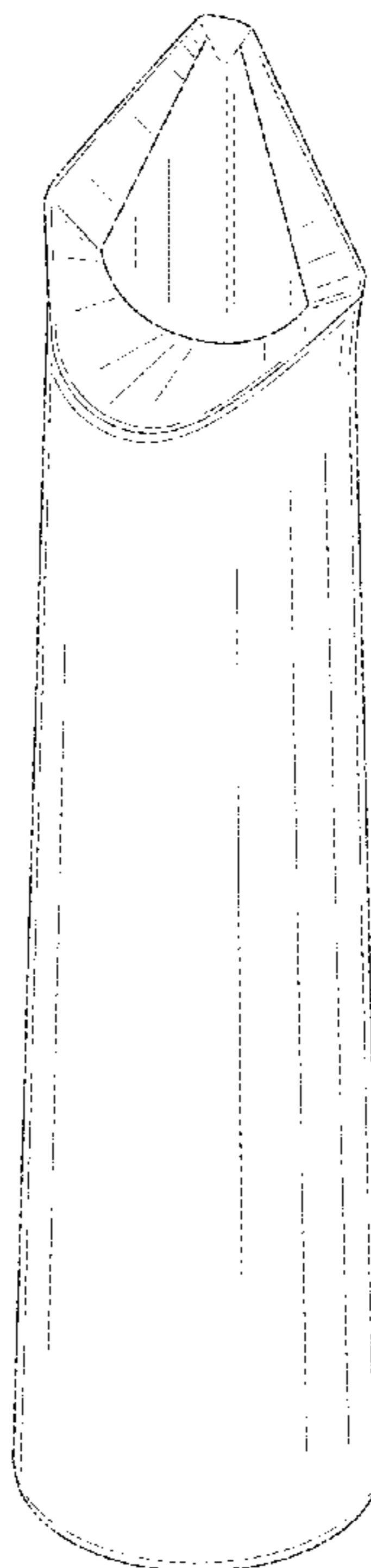

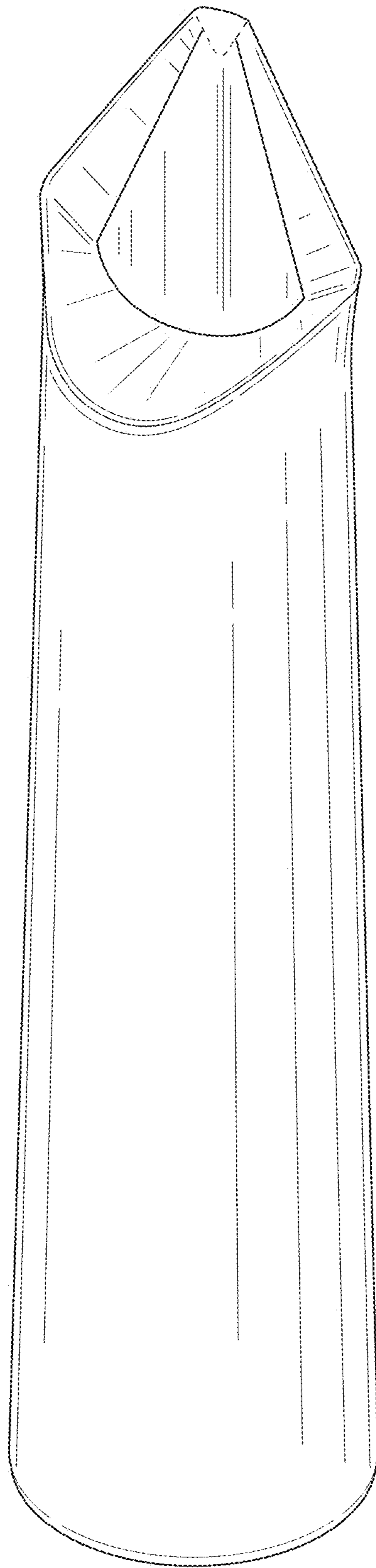

FIG. 1

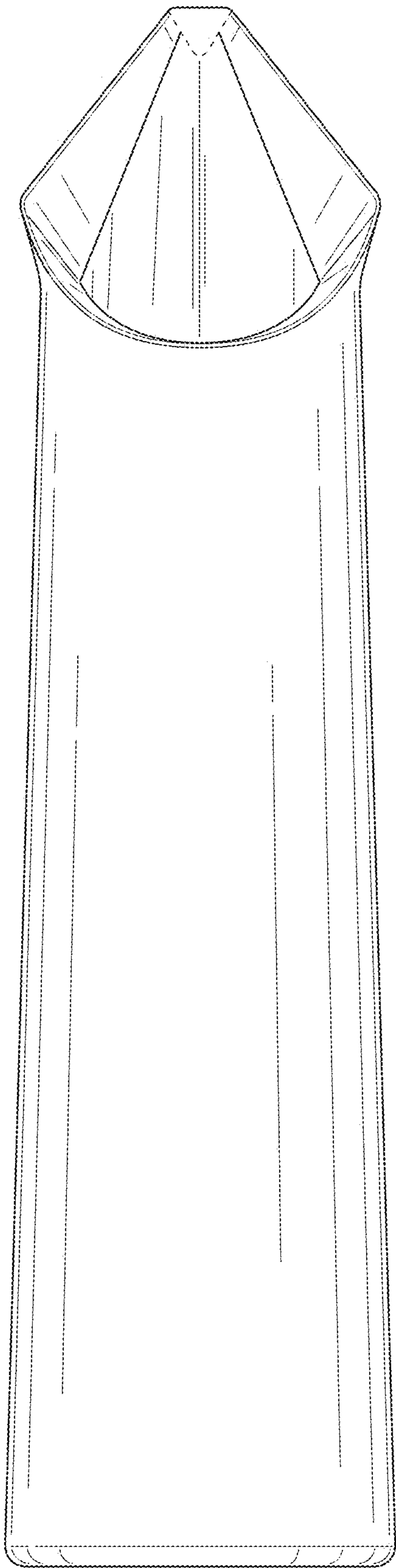

FIG. 2

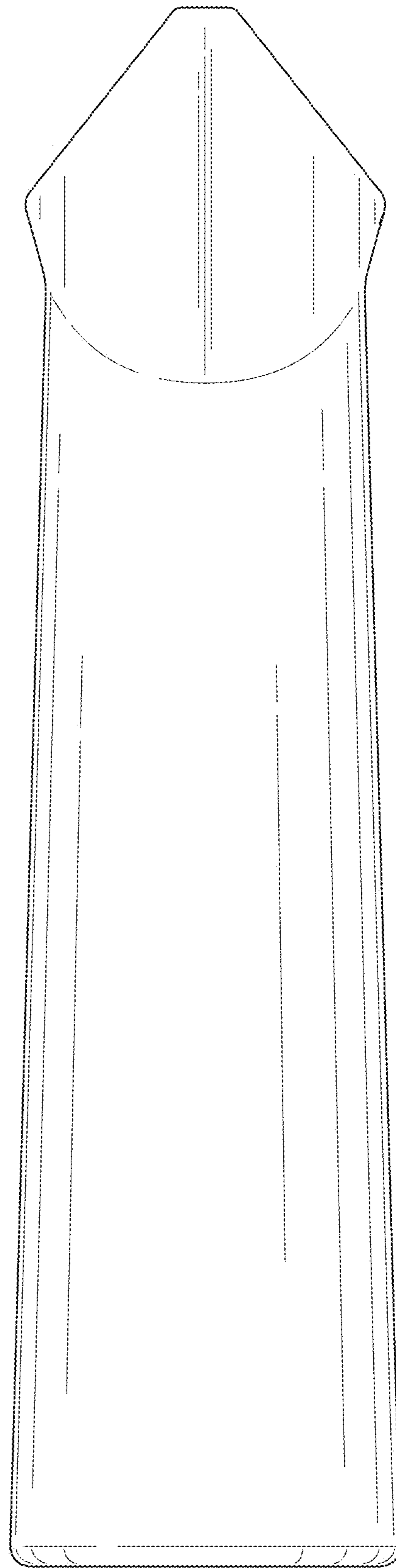

FIG. 3

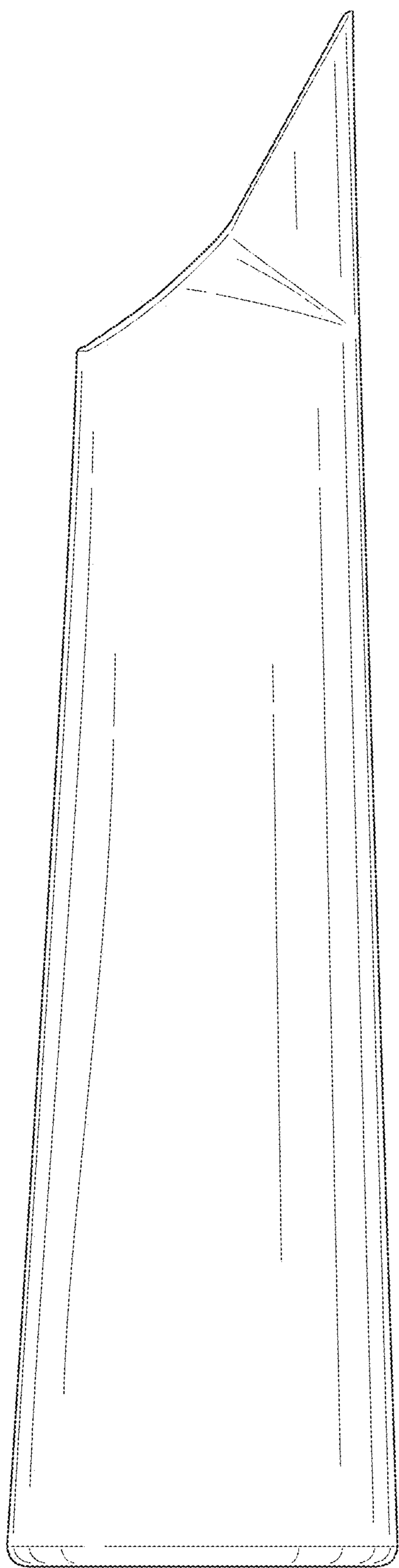

FIG. 4

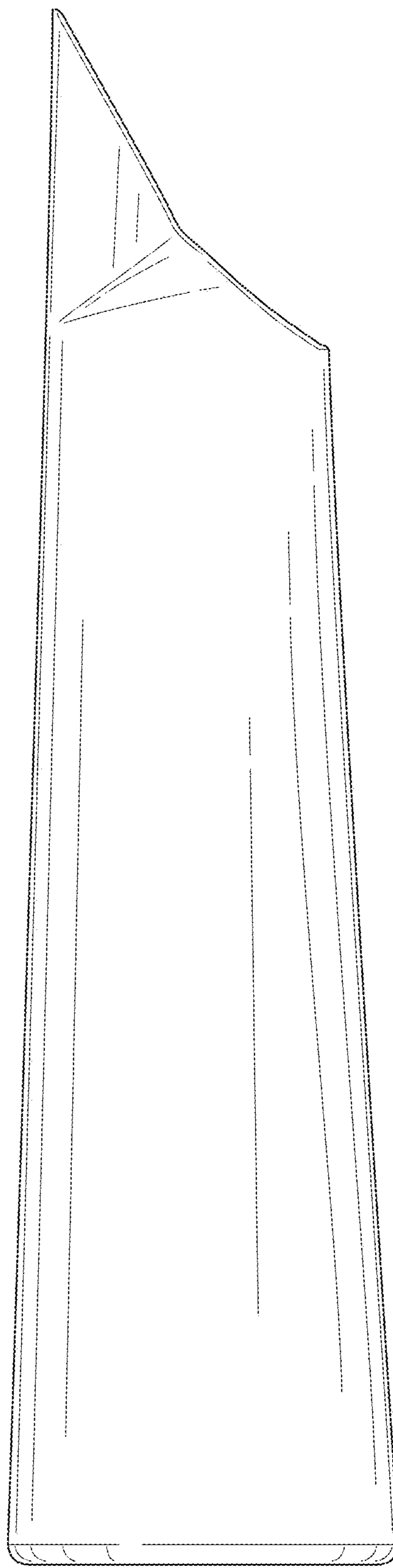

FIG. 5

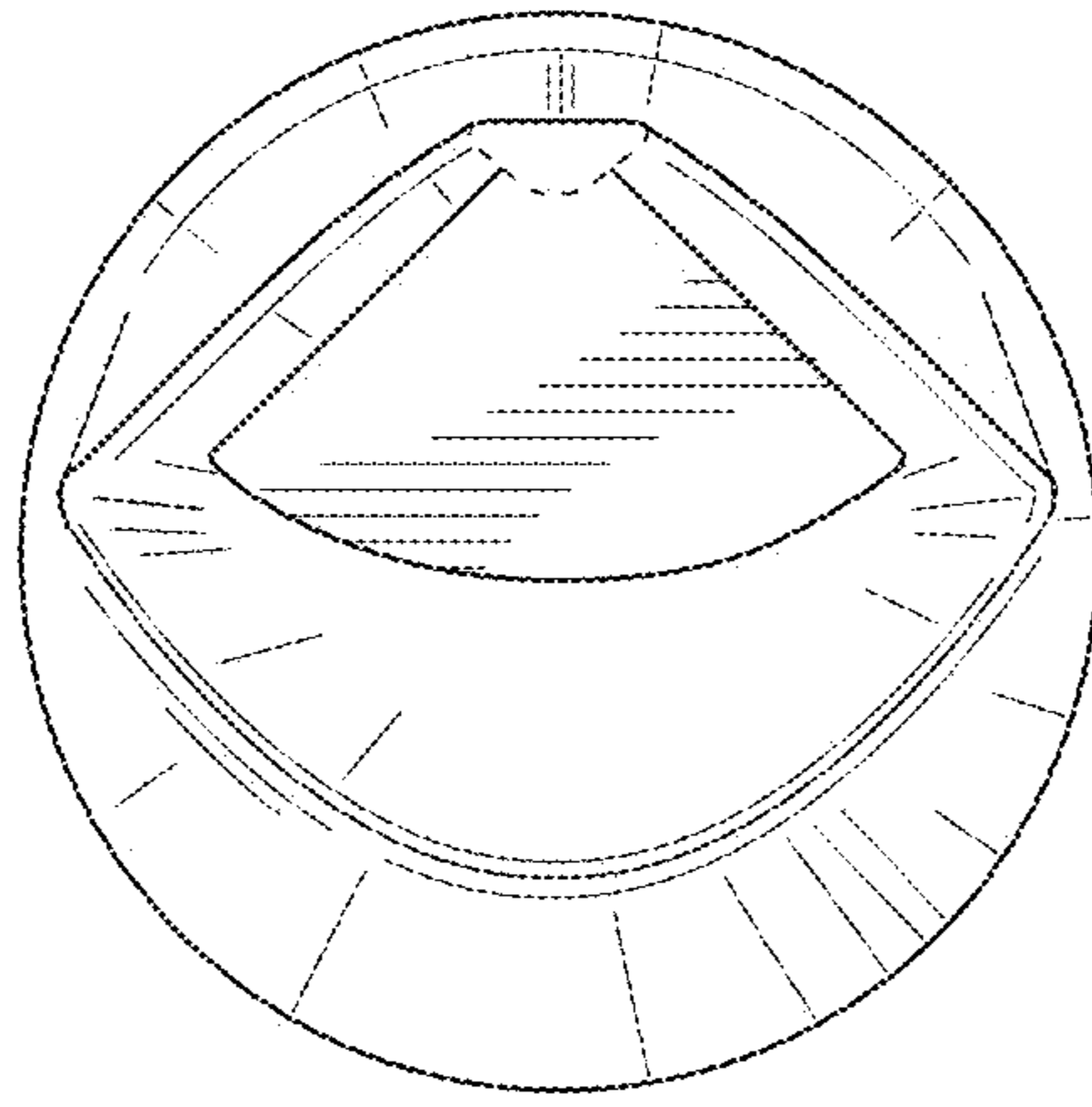

FIG. 6

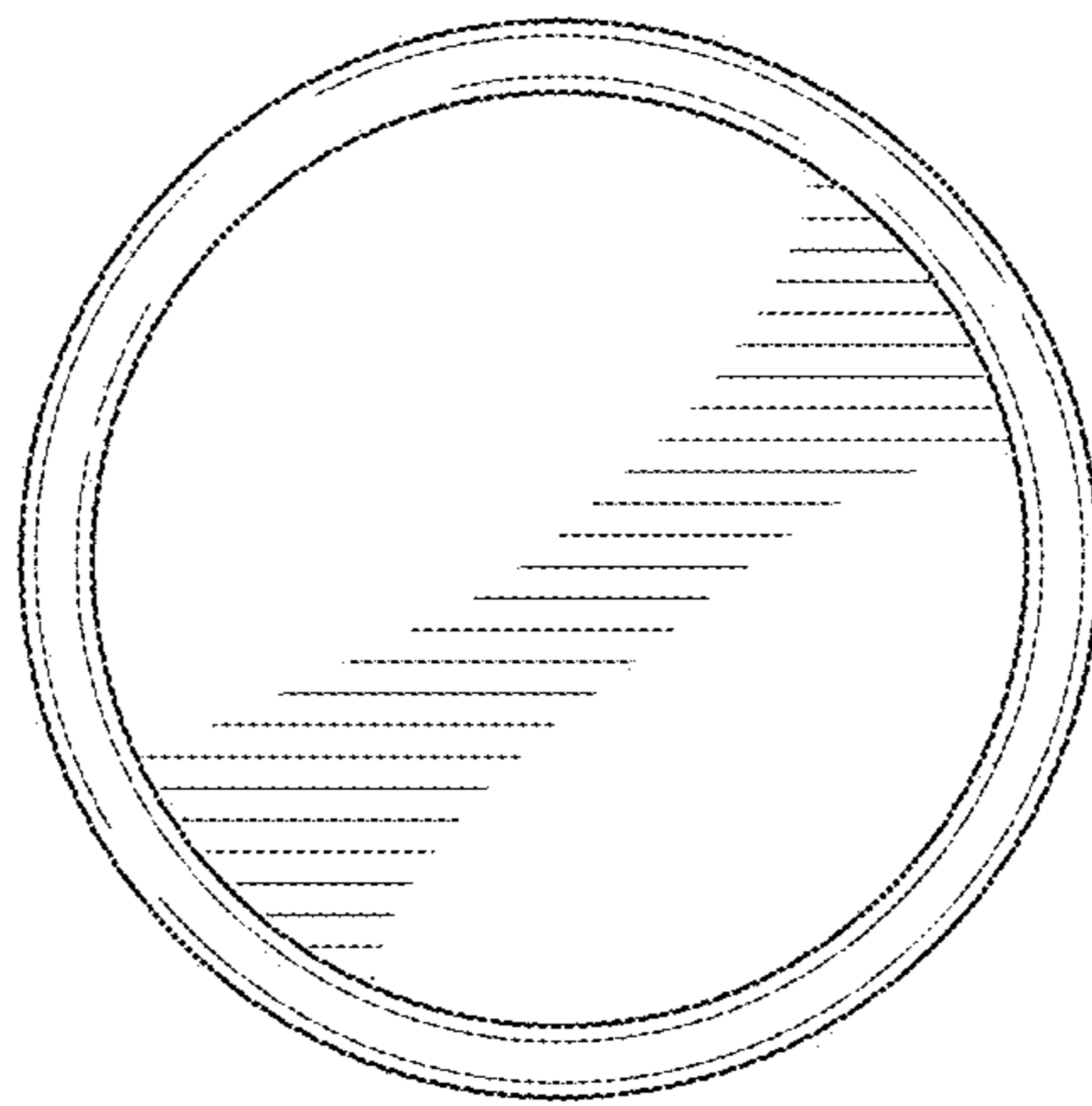

FIG. 7

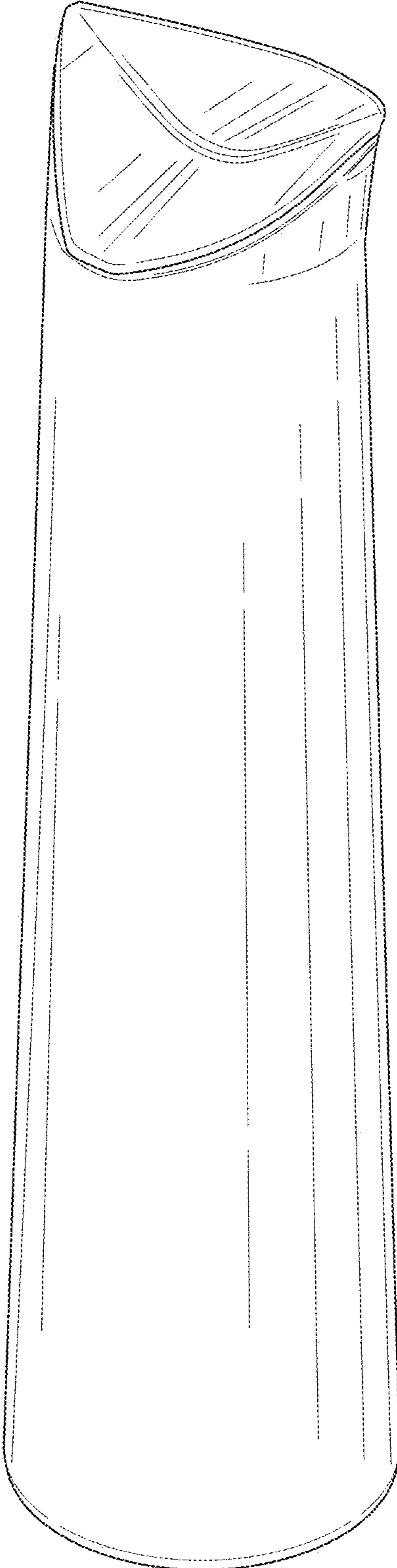

FIG. 8

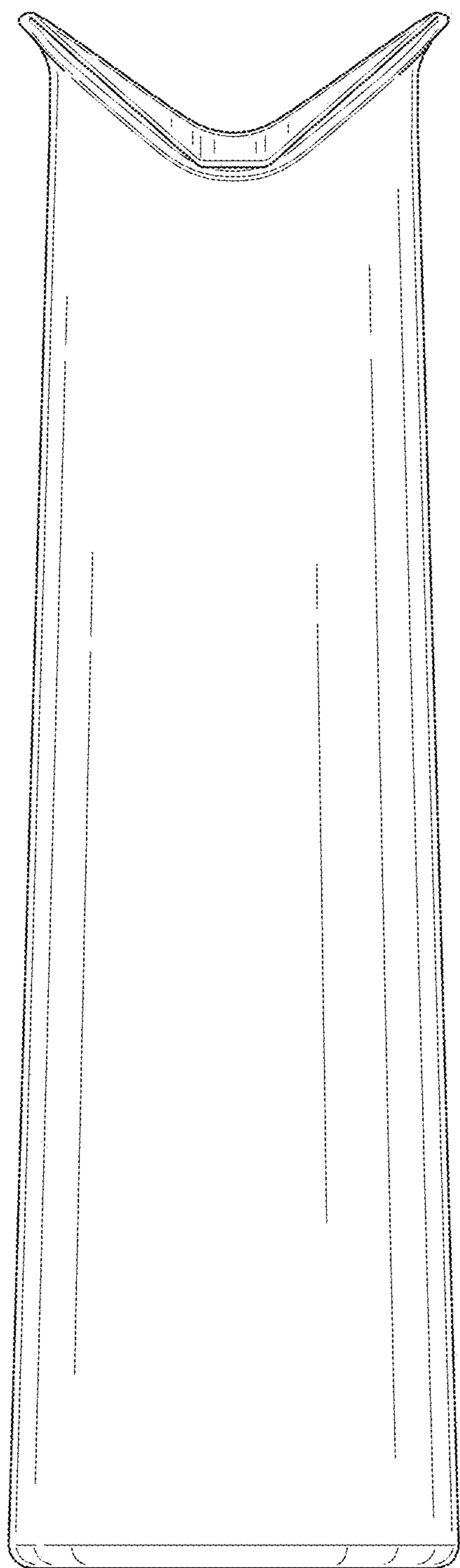

FIG. 9

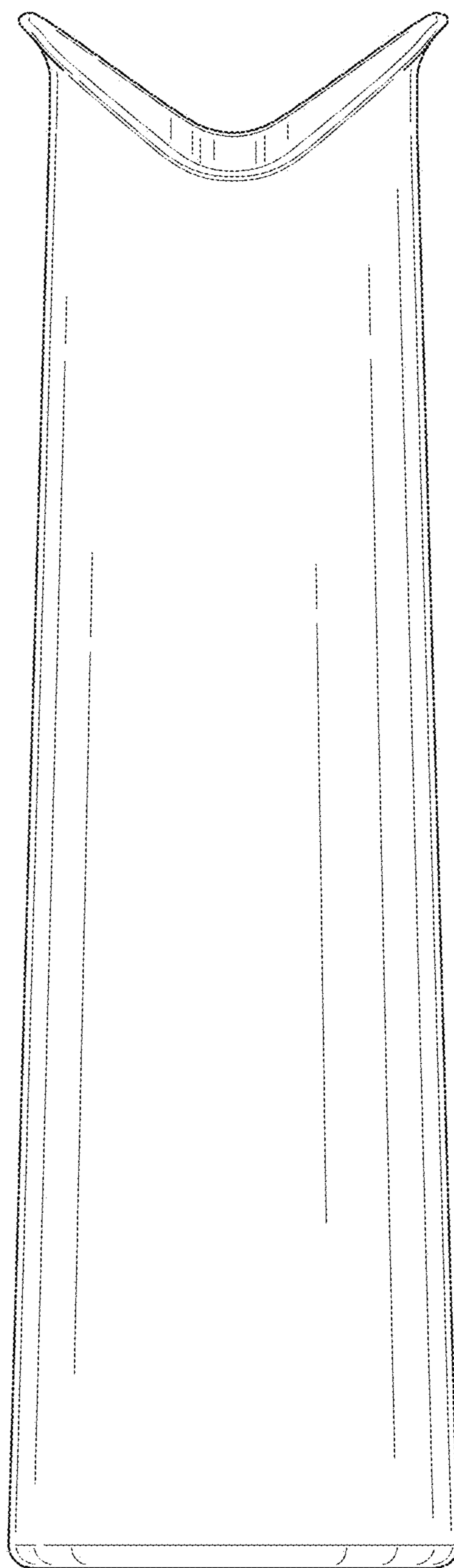

FIG. 10

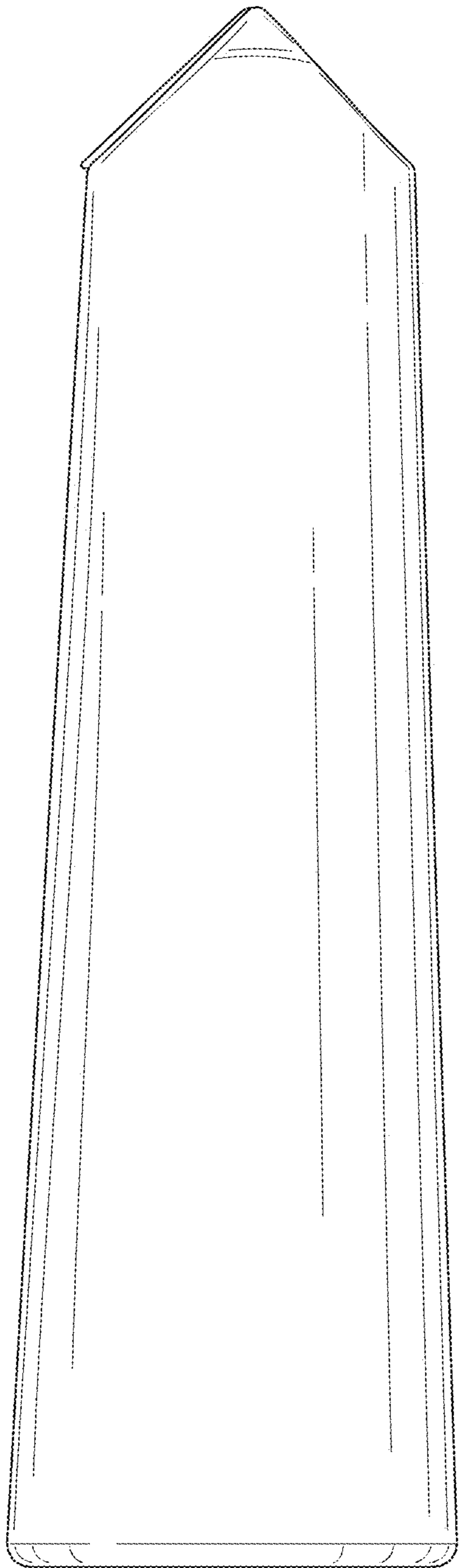

FIG. 11

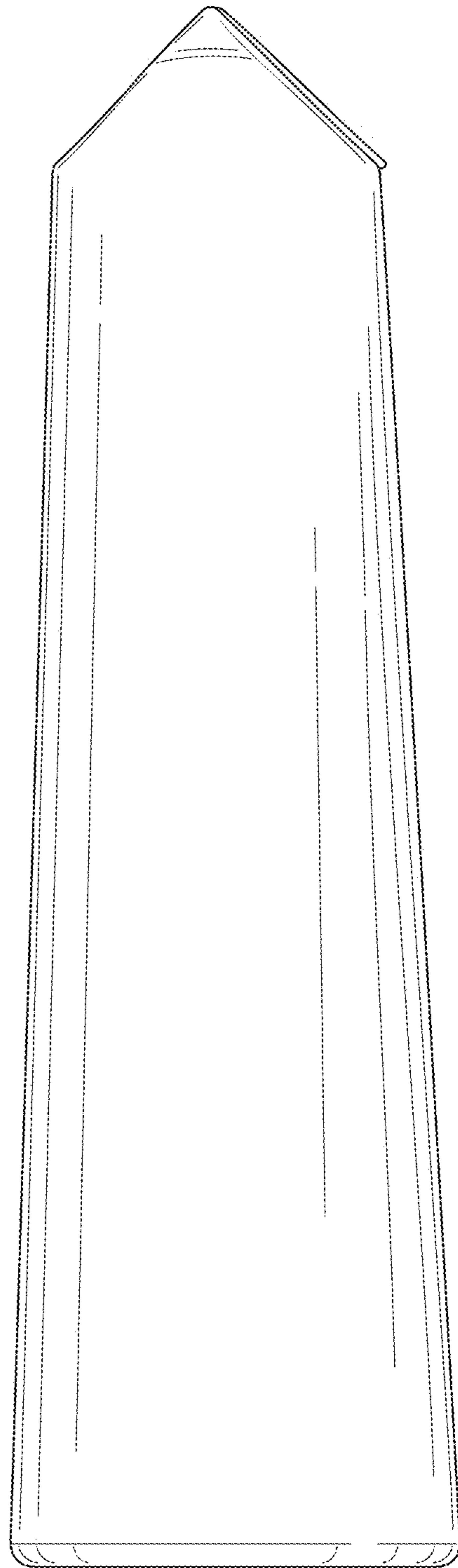

FIG. 12

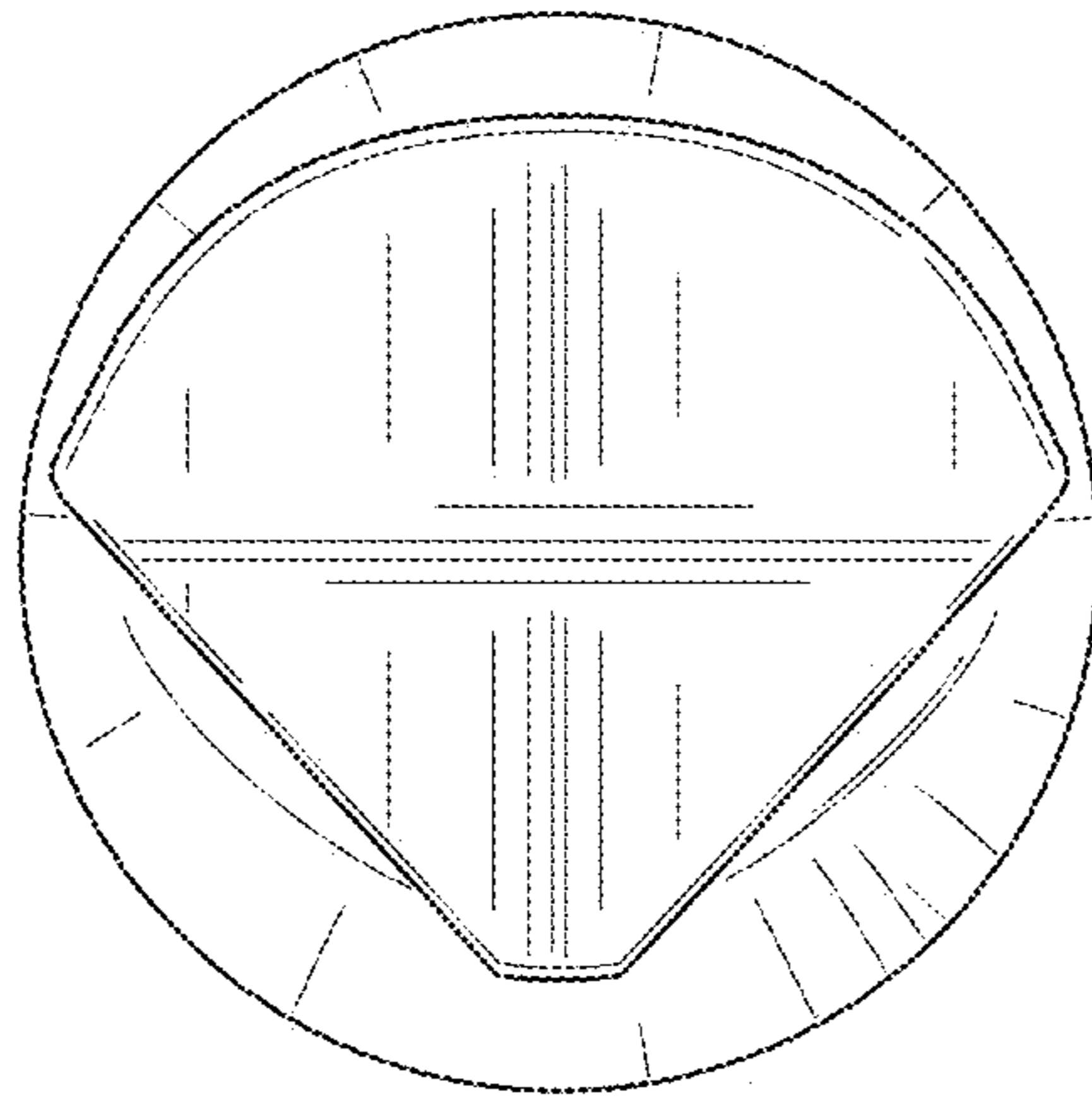

FIG. 13

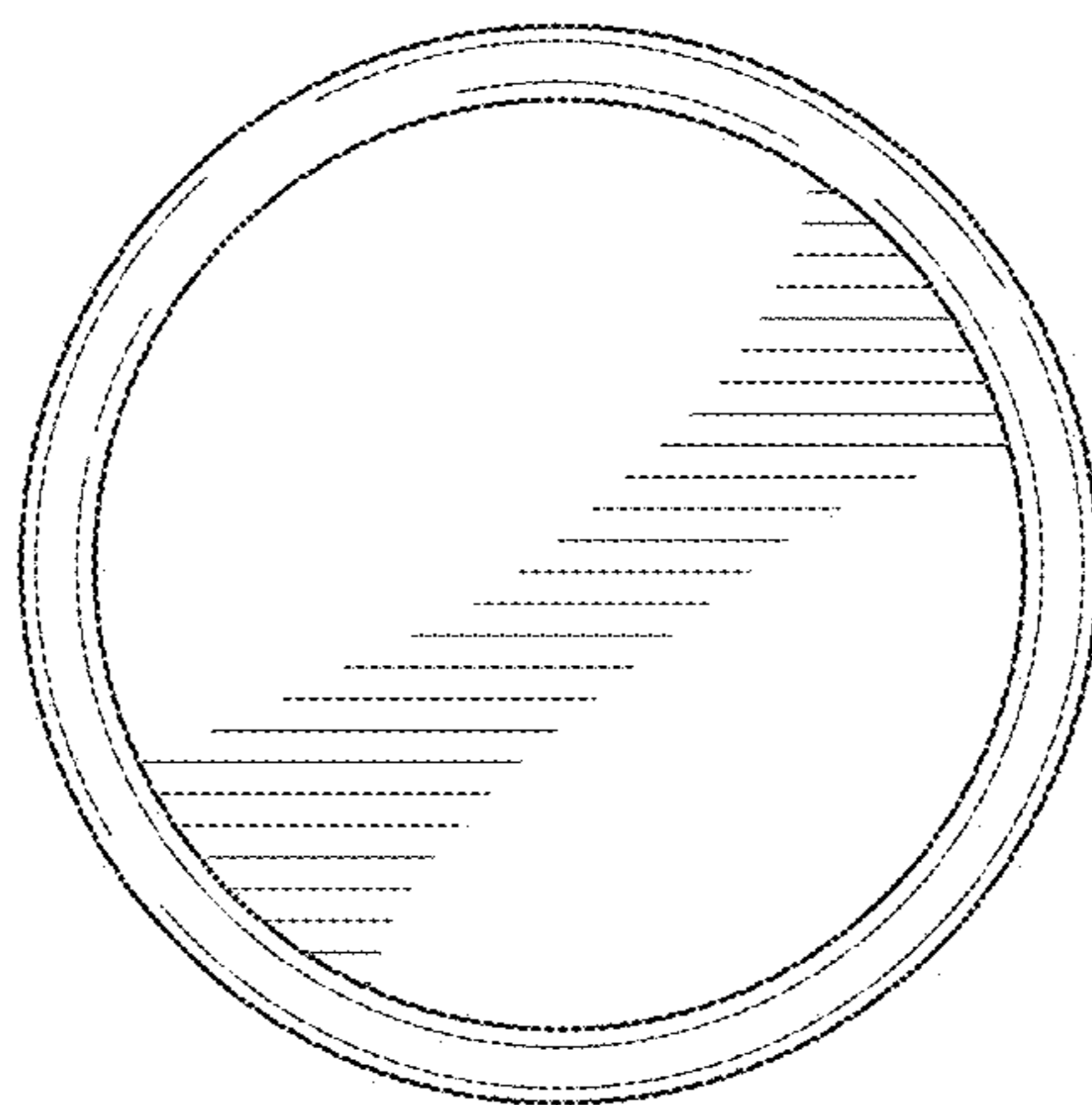

FIG. 14