



US00D918023S

(12) **United States Design Patent**
Underwood

(10) **Patent No.:** **US D918,023 S**

(45) **Date of Patent:** **** May 4, 2021**

(54) **SUPPORT DEVICE**

(71) Applicant: **Susan Evans Underwood**, Monroe, LA (US)

(72) Inventor: **Susan Evans Underwood**, Monroe, LA (US)

(**) Term: **15 Years**

(21) Appl. No.: **29/604,864**

(22) Filed: **May 22, 2017**

(51) **LOC (13) Cl.** **08-05**

(52) **U.S. Cl.**
USPC **D8/373**

(58) **Field of Classification Search**

USPC D08/373, 358, 359, 354, 71, 330, 336, D08/351, 356, 360.1, 363, 364, 367, 370, D08/372, 379, 381, 382, 395, 396; D06/349, 352; D09/426, 502, 750; D10/72, 73, 89; D11/79, 93; D13/103, D13/107; D19/67; D21/673, 674, 675, D21/839, 840; D25/19, 62, 68, 69; D26/40, 49; D29/122, 124; D30/153, D30/155

CPC B65H 75/40; B65H 75/4407; B65H 75/4471; B65H 2701/34; B65H 2701/32; B65H 2511/142; B65H 29/008; B65H 2701/33; B65H 54/585; B65H 51/22; B65H 75/08; B65H 75/02; B65H 2301/41485; B65H 75/4468; B65H 2301/414323; B65H 2301/414325; B65H 16/02; B65H 2301/4131; B65H 75/403; B65H 75/441; B65D 85/66; B65D 85/67; B66D 3/006; B66D 3/18; B66D 3/26; B66D 3/02; B66D 3/14; B63B 21/18; B63B 21/26; B65B 57/005; A61G 7/1051; A61G 7/1061; B66B 11/08; A62C 33/04; B08B 2203/0276; B21C 47/28; H02G 11/02; A01K 89/003; H04M 1/15; A01D 34/822; A47L 9/26; E05C 19/10; E05C 17/50; E05C 3/045; E05C 3/30; E05C 19/02; E05C 19/026; A47G

25/0614; A47G 25/18; A47G 25/32; A47G 7/047; A47G 7/045; A47G 7/042; A47G 7/044; F16B 12/44; F16B 12/46; F16B 5/0614; F16B 12/02; A47B 88/0055; E04B 1/2612; E04B 2001/2415; E04B 1/5818; E04B 1/5831; E04F 11/1812; F16L 1/0246; A01G 9/024; A01G 25/14; A01G

(Continued)

(56) **References Cited**

U.S. PATENT DOCUMENTS

D226,702 S * 4/1973 Moore D8/396
D263,764 S * 4/1982 McBride, II D30/155

(Continued)

Primary Examiner — George D. Kirschbaum

Assistant Examiner — Joseph J Kukella

(74) *Attorney, Agent, or Firm* — R. Keith Harrison

(57) **CLAIM**

The ornamental design for a support device, as shown and described.

DESCRIPTION

FIG. 1 is a front perspective view of a support device, showing my new design;
FIG. 2 is a top view thereof;
FIG. 3 is a bottom view thereof;
FIG. 4 is a right view thereof;
FIG. 5 is a left view thereof;
FIG. 6 is a front view thereof;
FIG. 7 is a rear view thereof; and,
FIG. 8 is a top view thereof, shown in an environment of use. The broken line showing of a hanging hook in FIGS. 1-5 and 8 and a rectangular support in FIG. 8 depicts environment. The remaining broken lines shown in the figures depict portions of the support device. The broken lines form no part of the claimed design.

1 Claim, 8 Drawing Sheets

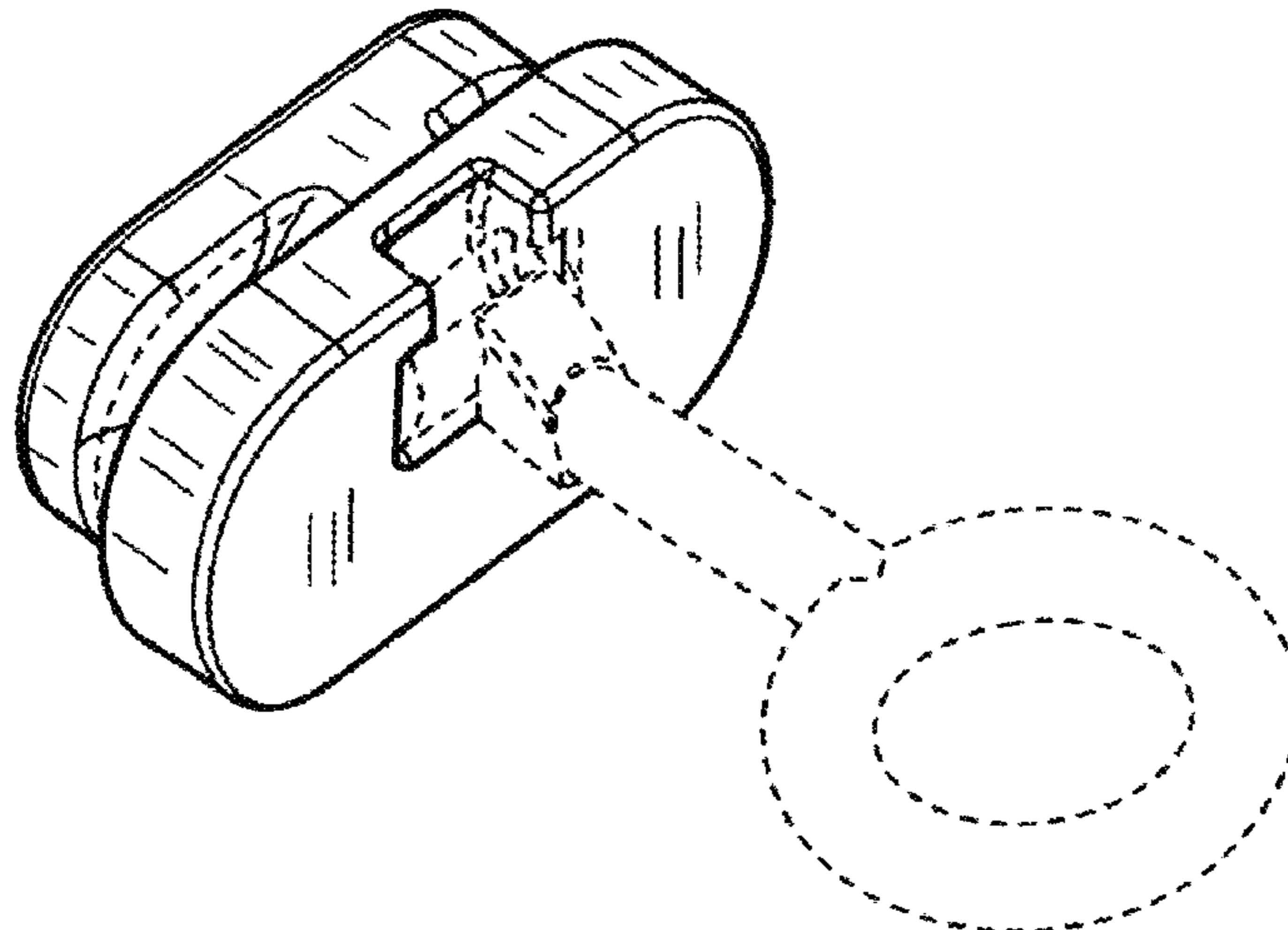

(58) **Field of Classification Search**

CPC 27/001; A01G 9/042; A01G 27/005; A01G
31/001; A01G 9/02; A01G 9/083; A01G
9/12; H04R 1/1033; Y10S 24/909
See application file for complete search history.

(56) **References Cited**

U.S. PATENT DOCUMENTS

D415,407 S *	10/1999	Ducker	D8/354
D554,479 S *	11/2007	Rosine	D8/358
D611,333 S *	3/2010	Sanders	D8/394
D621,865 S *	8/2010	Chidester	D16/245
D631,728 S *	2/2011	Rainey	D8/349
D671,394 S *	11/2012	Derry	D8/373
D729,613 S *	5/2015	Biddle	D8/354
D734,133 S *	7/2015	Spindler	F21S 4/10 D8/367

* cited by examiner

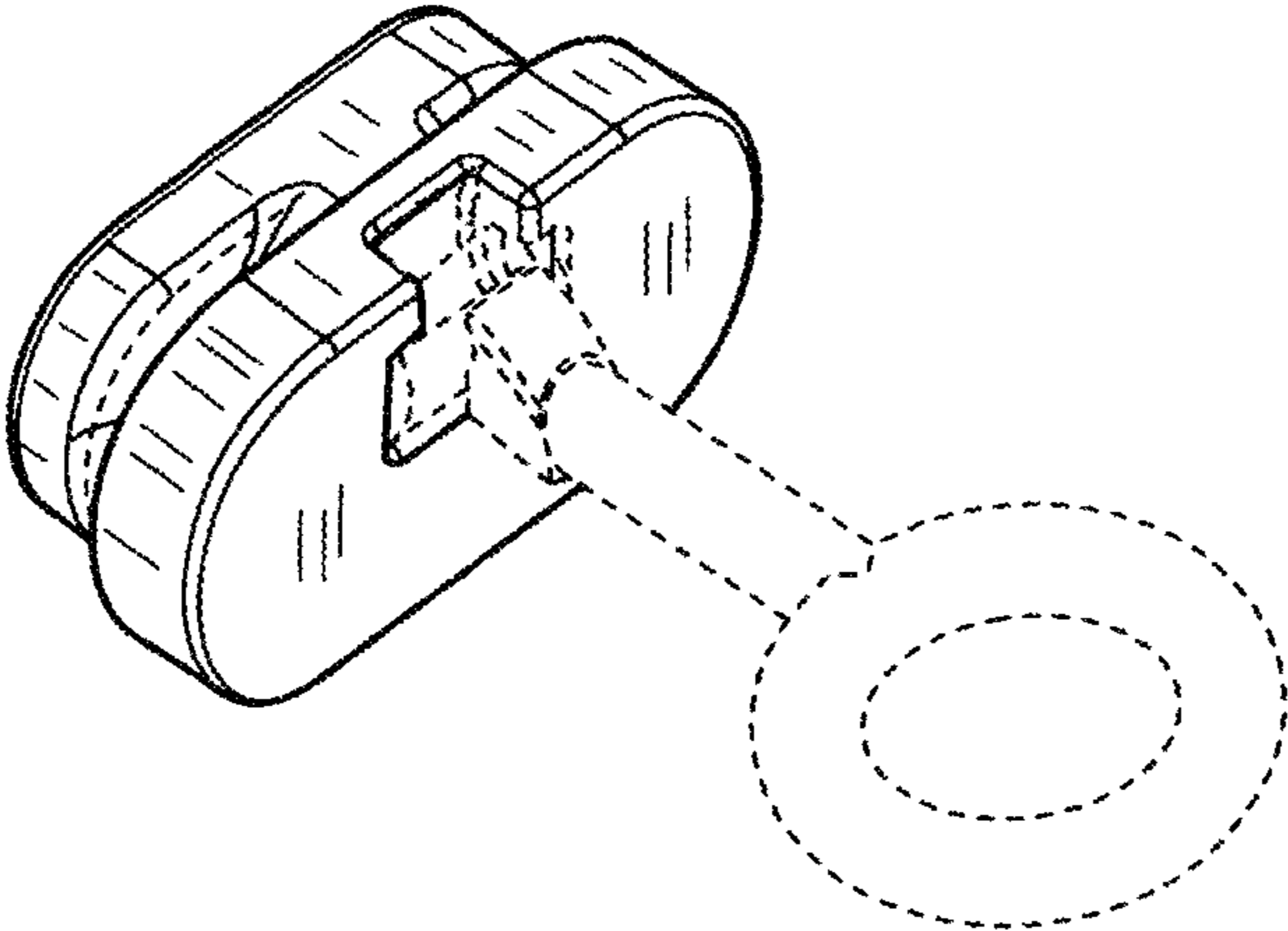

FIG. 1

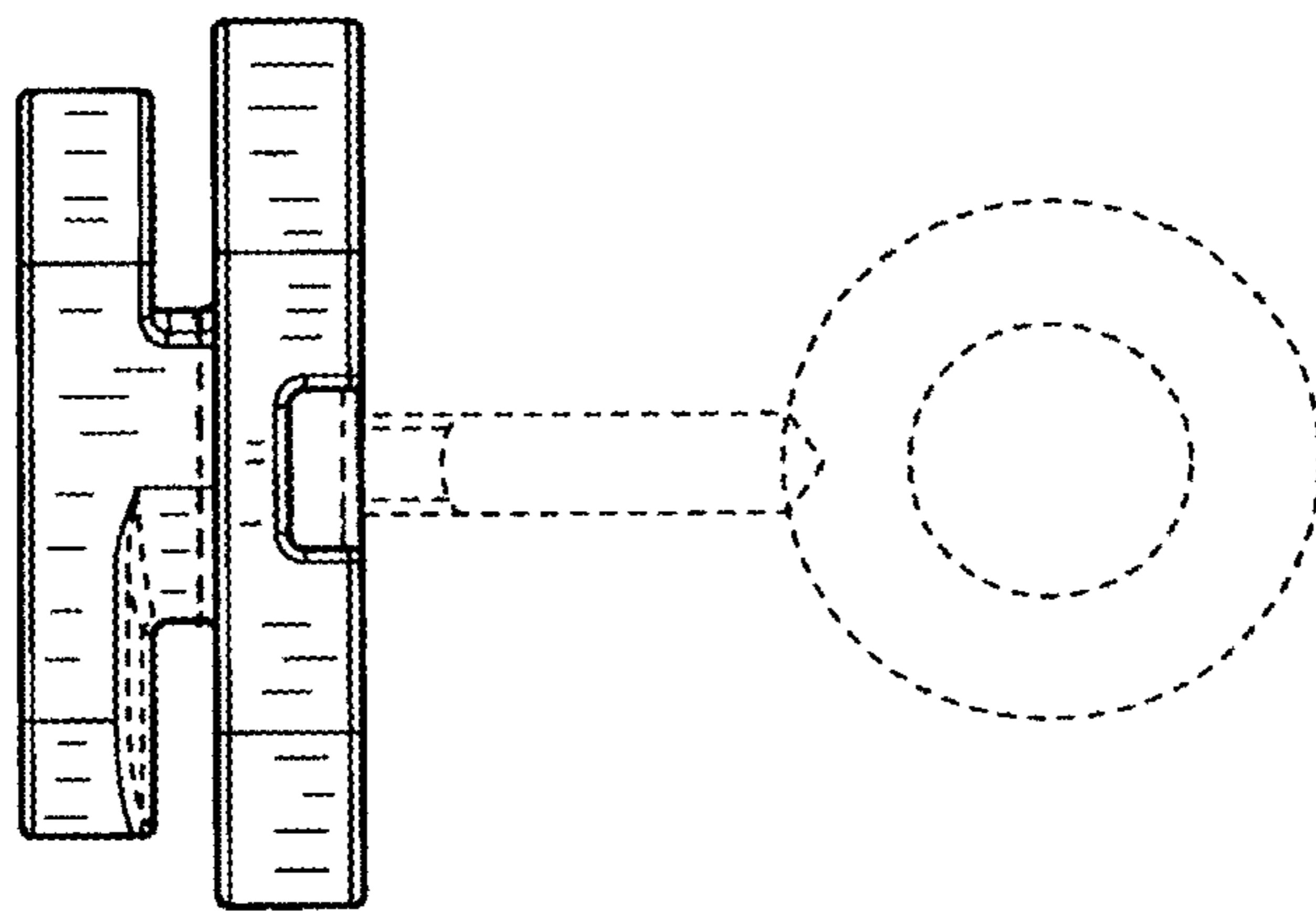

FIG. 2

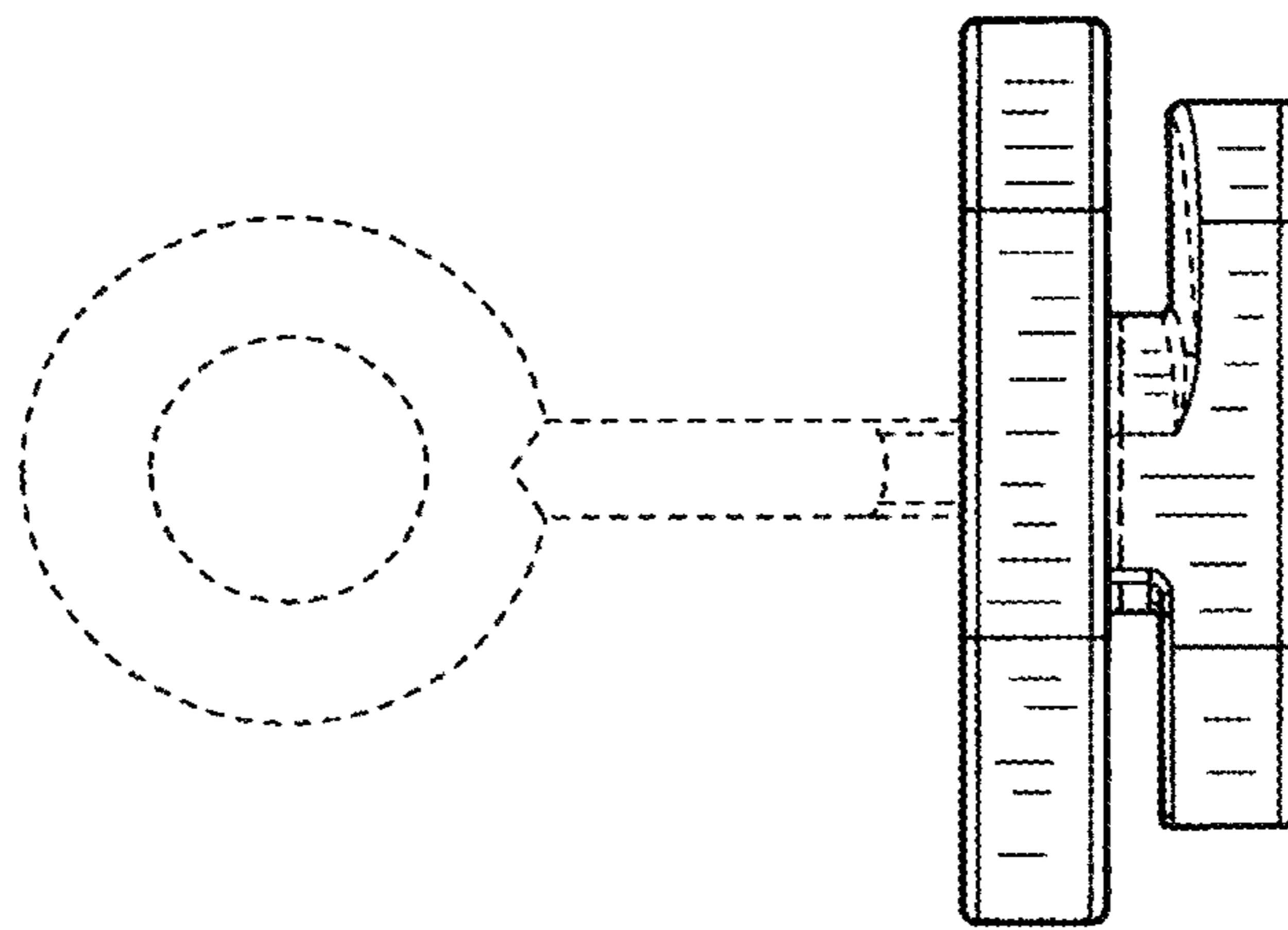

FIG. 3

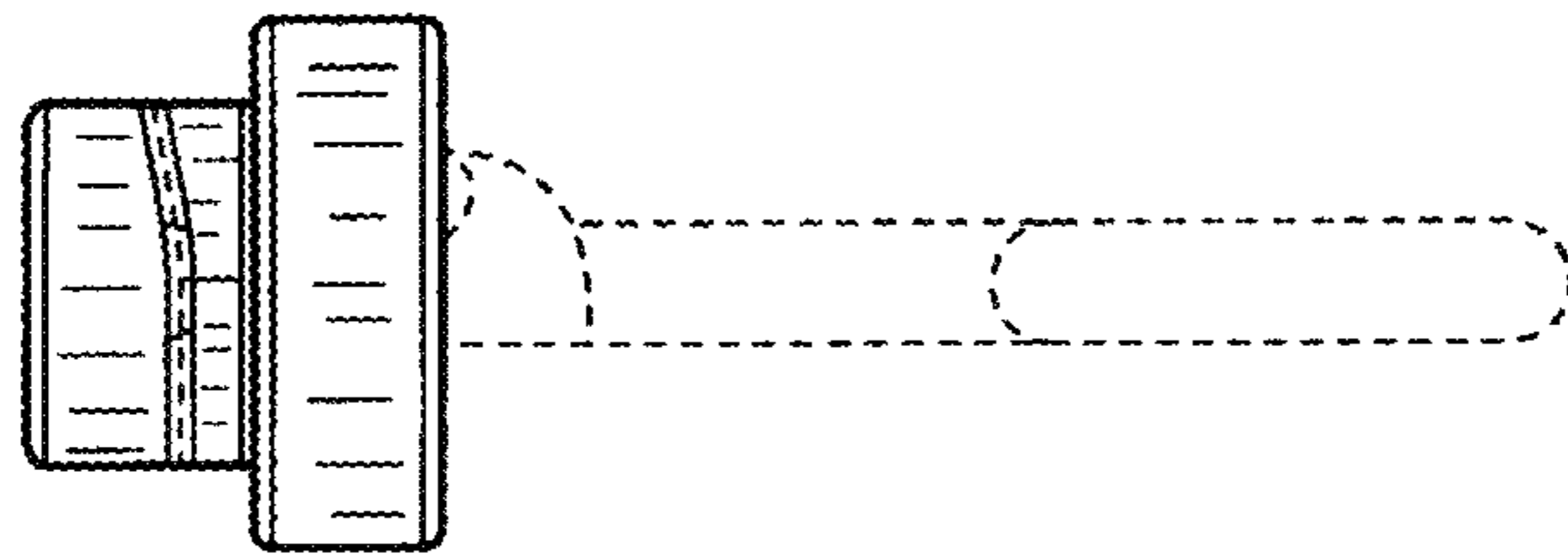

FIG. 4

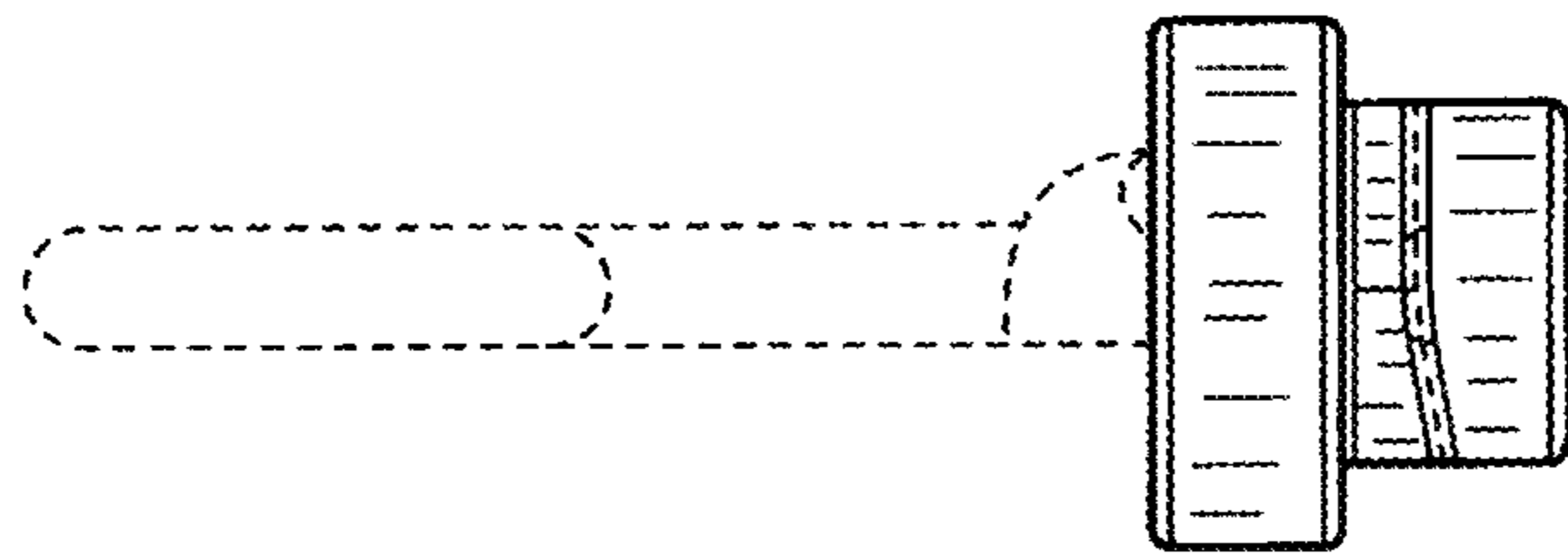

FIG. 5

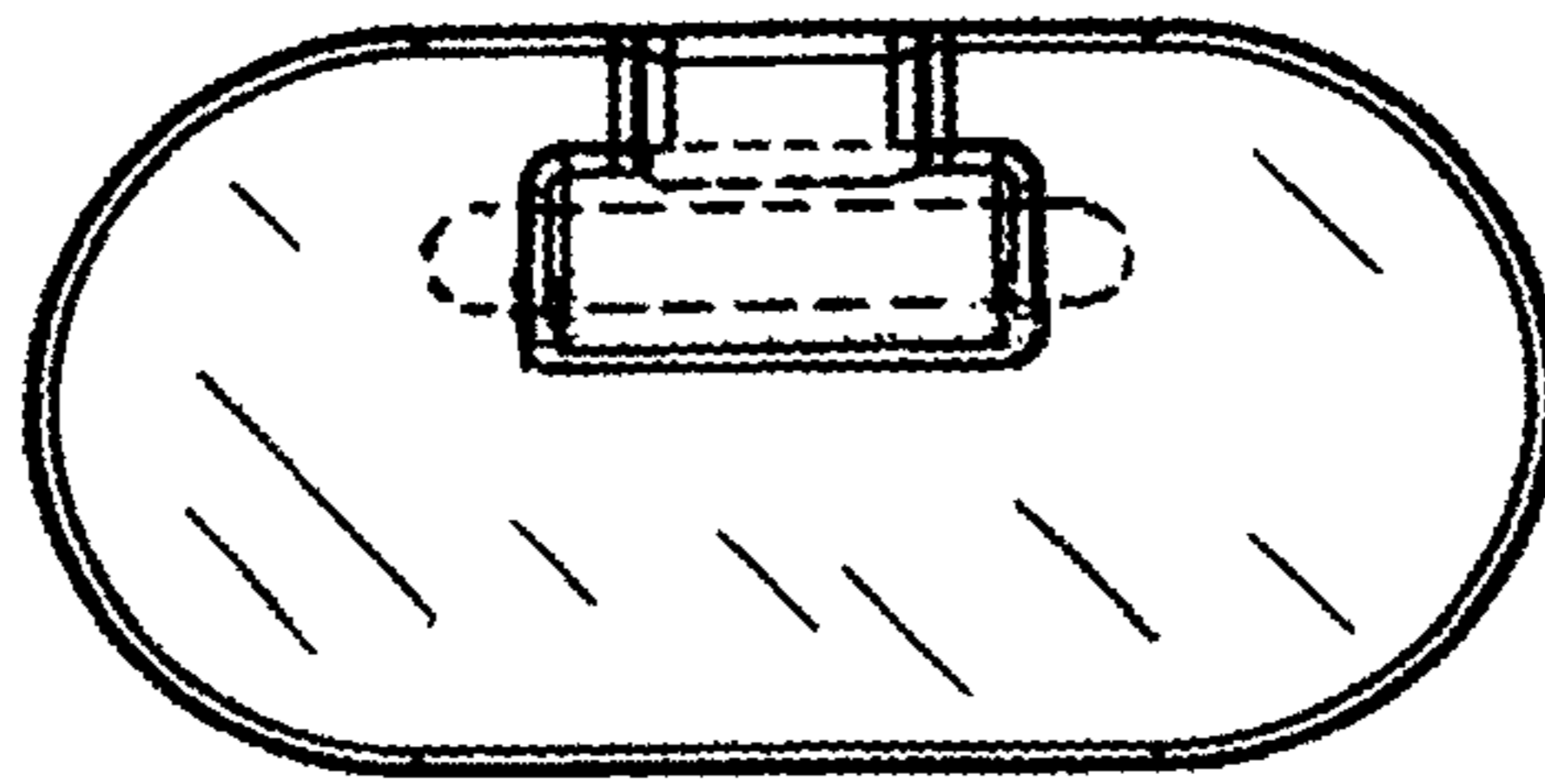

FIG. 6

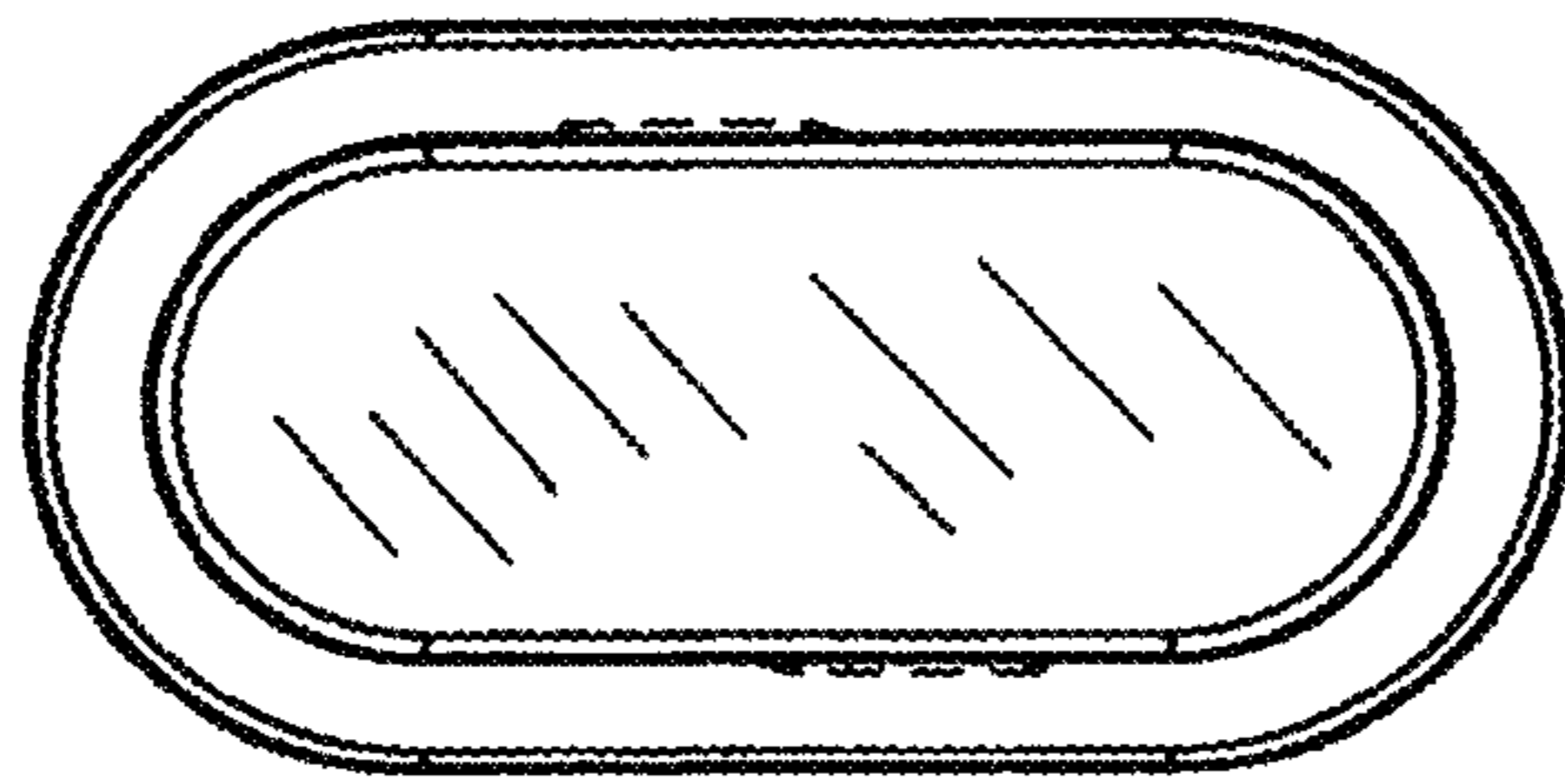

FIG. 7

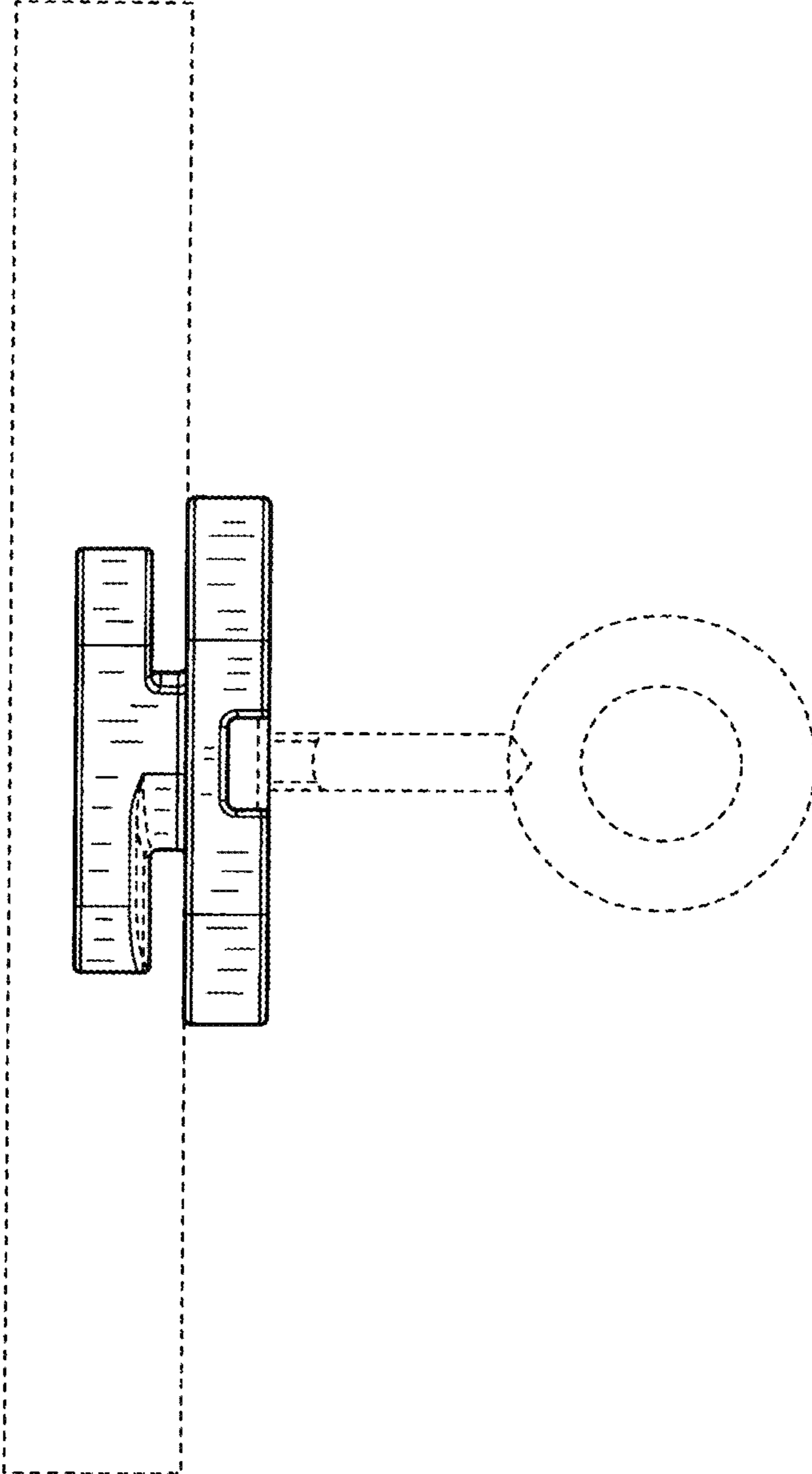

FIG. 8