



US00D917937S

(12) **United States Design Patent** (10) **Patent No.:** **US D917,937 S**
DeJesus et al. (45) **Date of Patent:** **** May 4, 2021**

(54) **RETAIL FIXTURE**
(71) Applicant: **Apple Inc.**, Cupertino, CA (US)
(72) Inventors: **Manuel DeJesus**, San Francisco, CA (US); **Joshua Robert Edwards**, Santa Cruz, CA (US); **Jean-Marc Gady**, Los Altos, CA (US); **Wesley Bryan Hamm**, San Francisco, CA (US); **Russell John Kaaihue Heirakuji**, Cupertino, CA (US); **Allison Inouye**, San Francisco, CA (US); **Moritz Wilsberg**, Rheinbreitbach (DE)

D303,190 S 9/1989 Suttles
4,886,327 A * 12/1989 Amstutz A47F 3/005
312/257.1
D305,286 S * 1/1990 Otema D6/661
D347,755 S * 6/1994 Houston D6/699
D406,964 S 3/1999 Lewis
D427,814 S 7/2000 Black
D427,815 S 7/2000 Lewis

(Continued)

FOREIGN PATENT DOCUMENTS

KR 30-0703066 7/2013
Primary Examiner — Kelley A Donnelly
(74) *Attorney, Agent, or Firm* — Sterne, Kessler, Goldstein & Fox P.L.L.C.

(73) Assignee: **Apple Inc.**, Cupertino, CA (US)

(**) Term: **15 Years**

(21) Appl. No.: **29/741,447**

(22) Filed: **Jul. 13, 2020**

(57) **CLAIM**

The ornamental design for a retail fixture, as shown and described.

Related U.S. Application Data

(63) Continuation of application No. 29/655,967, filed on Jul. 9, 2018, now Pat. No. Des. 889,887.

(51) **LOC (13) Cl.** **06-06**

(52) **U.S. Cl.**
USPC **D6/675**

(58) **Field of Classification Search**
USPC D6/672, 675, 675.1, 678, 678.1, 682, 682.3, 682.4, 683, 683.1
CPC A47B 73/00; A47B 73/002; A47B 47/00; A47B 47/008; A47B 47/25; A47F 5/00; A47F 5/0062

See application file for complete search history.

DESCRIPTION

FIG. 1 is a top front perspective view of a retail fixture showing the claimed design;
FIG. 2 is a front view thereof;
FIG. 3 is a rear view thereof;
FIG. 4 is a left side view thereof;
FIG. 5 is a right side view thereof;
FIG. 6 is a top view thereof;
FIG. 7 is a bottom view thereof;
FIG. 8 is a top front perspective view of another retail fixture showing the claimed design;
FIG. 9 is a front view thereof;
FIG. 10 is a rear view thereof;
FIG. 11 is a left side view thereof;
FIG. 12 is a right side view thereof;
FIG. 13 is a top view thereof; and,
FIG. 14 is a bottom view thereof.

The dashed broken lines in the figures show portions of the retail fixture that form no part of the claimed design.

(56) **References Cited**

U.S. PATENT DOCUMENTS

D248,345 S 7/1978 Stoddard
D274,203 S * 6/1984 Everett D6/675.4
D300,966 S 5/1989 Colby

1 Claim, 14 Drawing Sheets

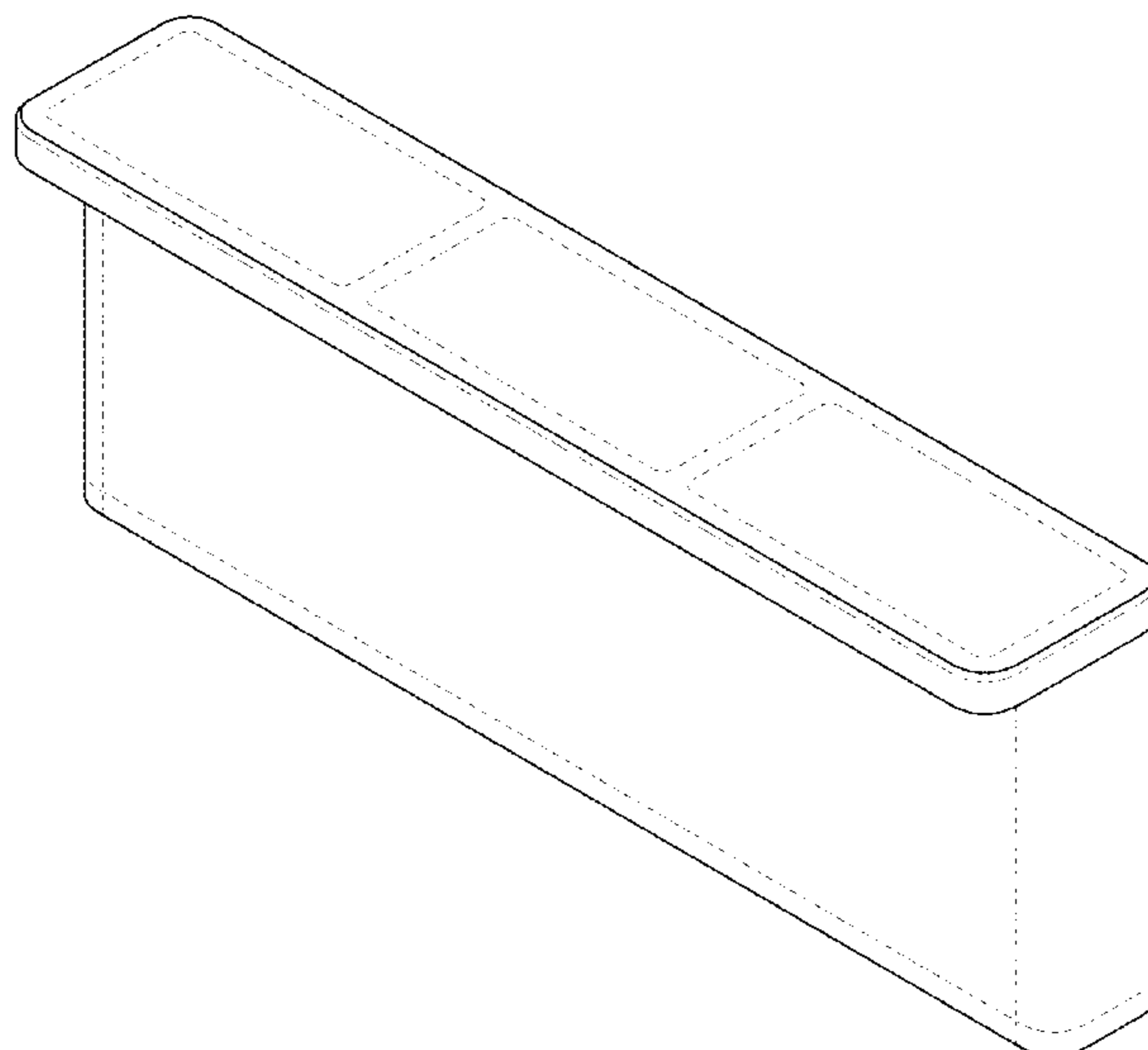

(56)

References Cited

U.S. PATENT DOCUMENTS

D465,936 S	11/2002	Arnold	D729,560 S	5/2015	Hamm et al.
D466,337 S	12/2002	Feng	D730,071 S	5/2015	Sorel
D530,548 S	10/2006	McCurry	D734,631 S	7/2015	Velez
D539,569 S	4/2007	Lewis	D740,595 S *	10/2015	Kim D6/672
D582,169 S	12/2008	Skalka	D741,616 S	10/2015	Sneve et al.
D583,577 S	12/2008	Wicha	D750,921 S	3/2016	Kozak
D591,090 S	4/2009	Judkins	D753,419 S	4/2016	Heirakuji et al.
D599,570 S	9/2009	Skalka	D758,106 S	6/2016	Hamm et al.
D611,735 S	3/2010	Stukenberg	D763,016 S	8/2016	Clark et al.
D611,736 S	3/2010	Navone	D766,630 S	9/2016	Akana et al.
D651,651 S	1/2012	Beukema et al.	D766,631 S	9/2016	Akana et al.
D657,978 S	4/2012	Hamm et al.	D767,310 S	9/2016	Akana et al.
D659,415 S	5/2012	Soto et al.	D769,021 S	10/2016	Green et al.
D661,935 S	6/2012	Kozak et al.	D769,654 S	10/2016	Akana et al.
D672,594 S	12/2012	Kozak et al.	D776,471 S	1/2017	Mandon et al.
D678,696 S	3/2013	Hamm et al.	D783,324 S	4/2017	Akana et al.
D679,521 S	4/2013	Hamm et al.	D787,247 S *	5/2017	Price D6/699.2
D686,438 S	7/2013	Denby et al.	D788,506 S	6/2017	Choi
D688,494 S	8/2013	Hamm et al.	D795,613 S	8/2017	Hamm et al.
D693,156 S	11/2013	Hamm et al.	D796,234 S *	9/2017	Thaler D6/675
D693,610 S	11/2013	Denby et al.	D796,235 S *	9/2017	Morrell D6/675.2
D694,557 S	12/2013	Rodgers	D810,476 S	2/2018	Heirakuji et al.
D694,558 S	12/2013	Denby et al.	D821,116 S	6/2018	Hamm et al.
D705,556 S	5/2014	Udagawa	D846,313 S *	4/2019	Carral O' Gorman D6/652
D711,171 S *	8/2014	Brielmaier D6/675	D859,892 S *	9/2019	Tio D6/675
D713,190 S	9/2014	Behar	D869,210 S *	12/2019	Mangold D6/691.4
D713,658 S	9/2014	Smeds et al.	D873,056 S *	1/2020	Stafford D6/675
D717,554 S	11/2014	Kapka	D877,548 S	3/2020	Brugger et al.
D727,644 S	4/2015	Sorel	D885,800 S *	6/2020	Mills D6/672
D728,281 S	5/2015	Heirakuji et al.	D889,887 S *	7/2020	DeJesus D6/675
			D894,645 S *	9/2020	Ohmoto D6/675
			D900,513 S *	11/2020	Li D6/675

* cited by examiner

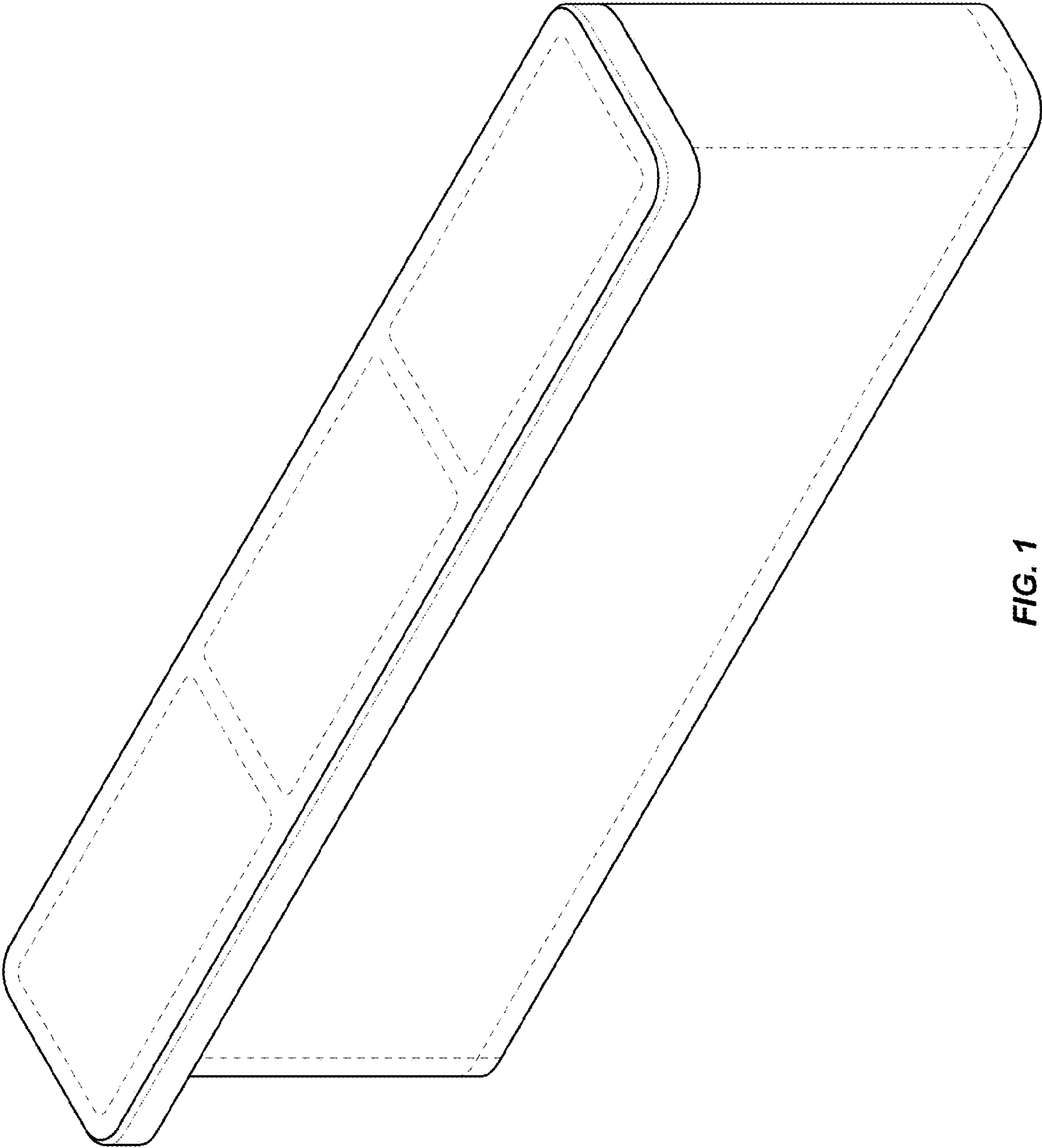

FIG. 1

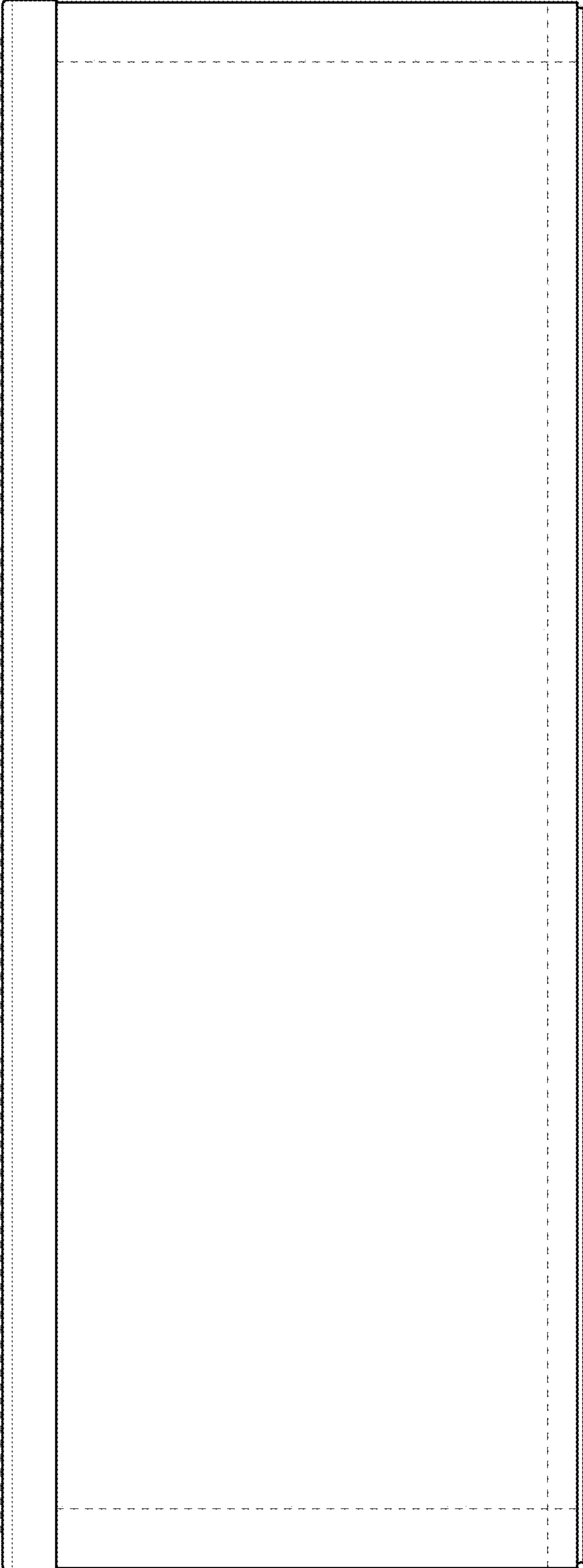

FIG. 2

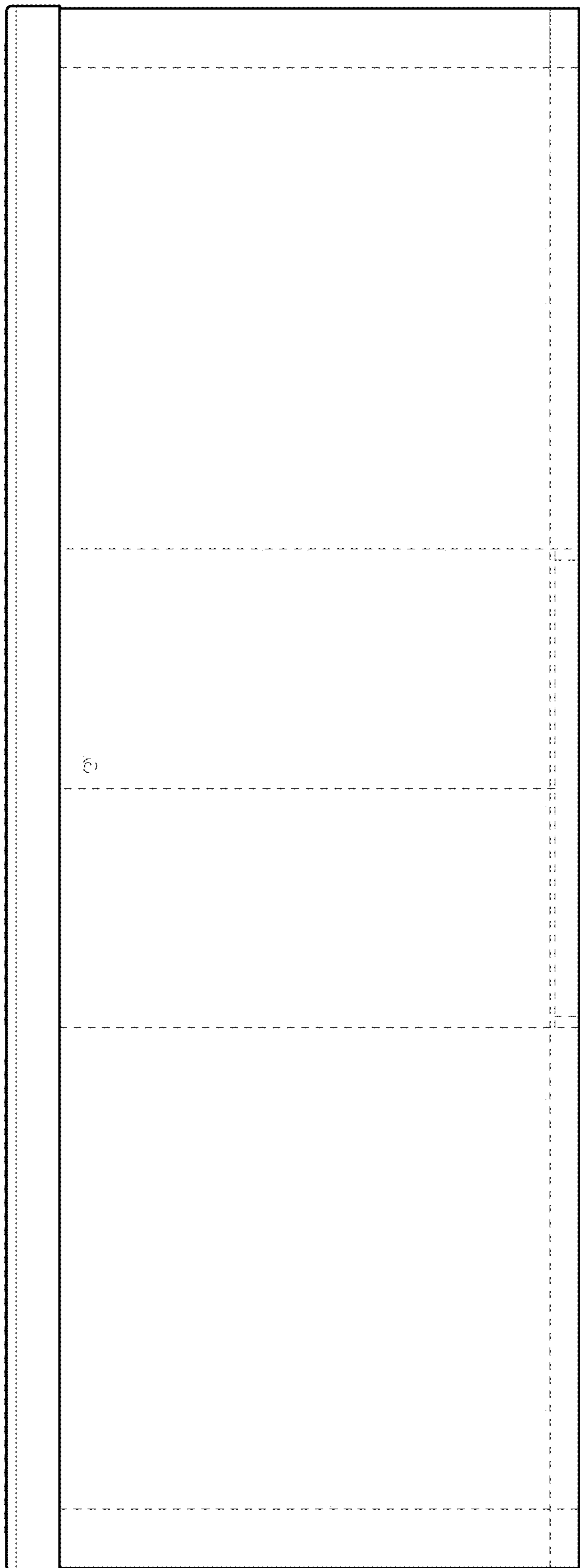

FIG. 3

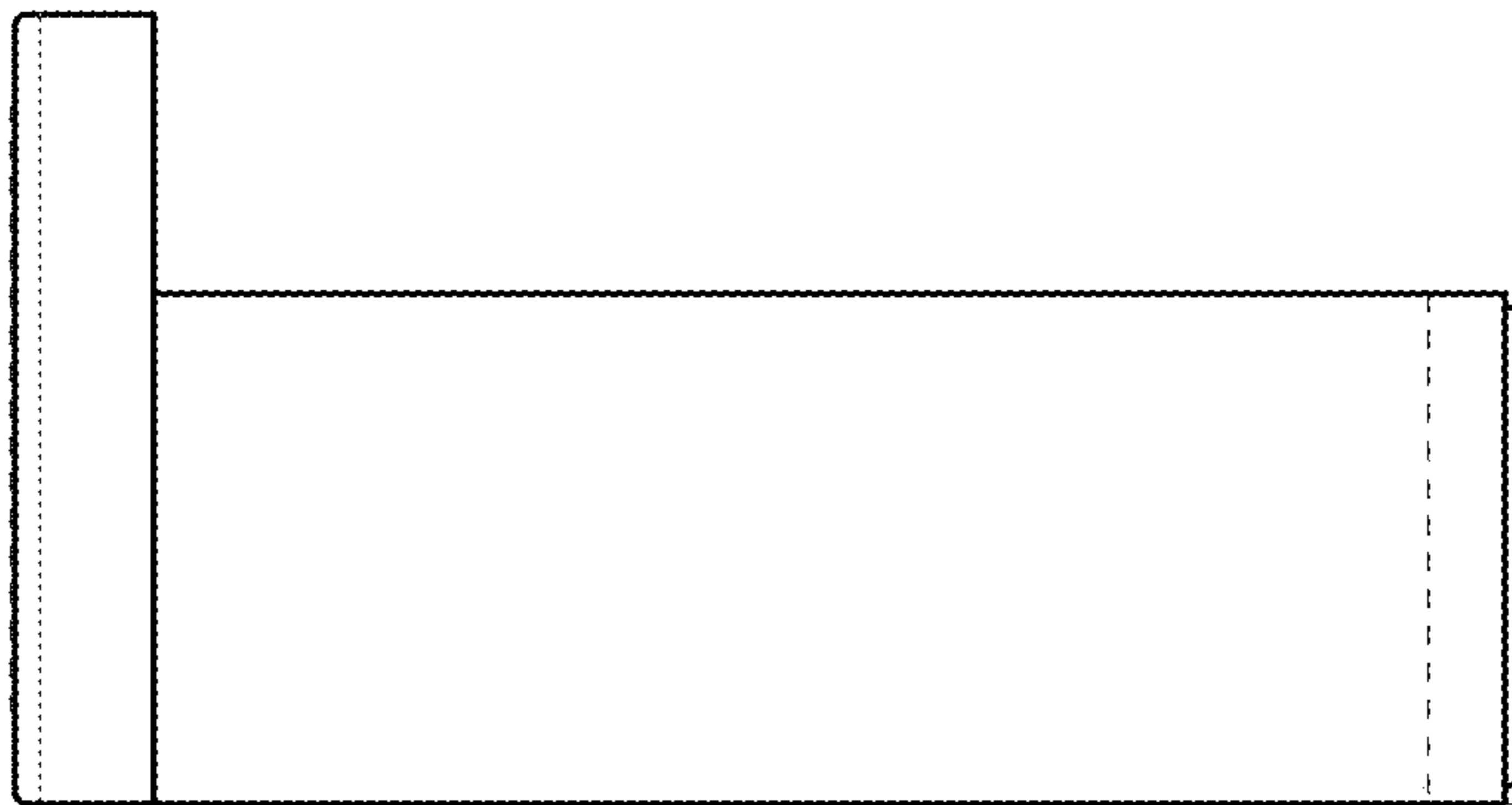

FIG. 4

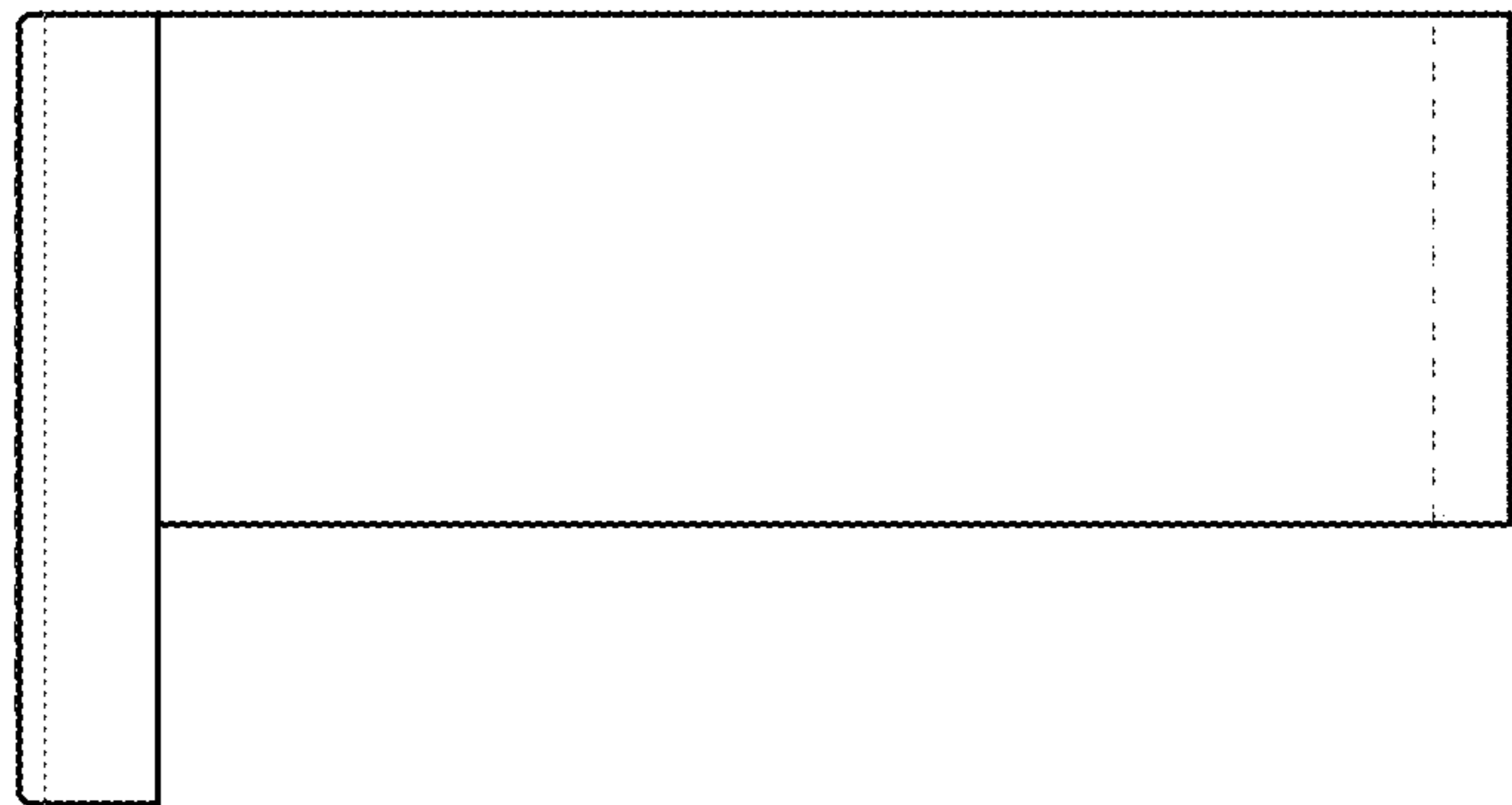

FIG. 5

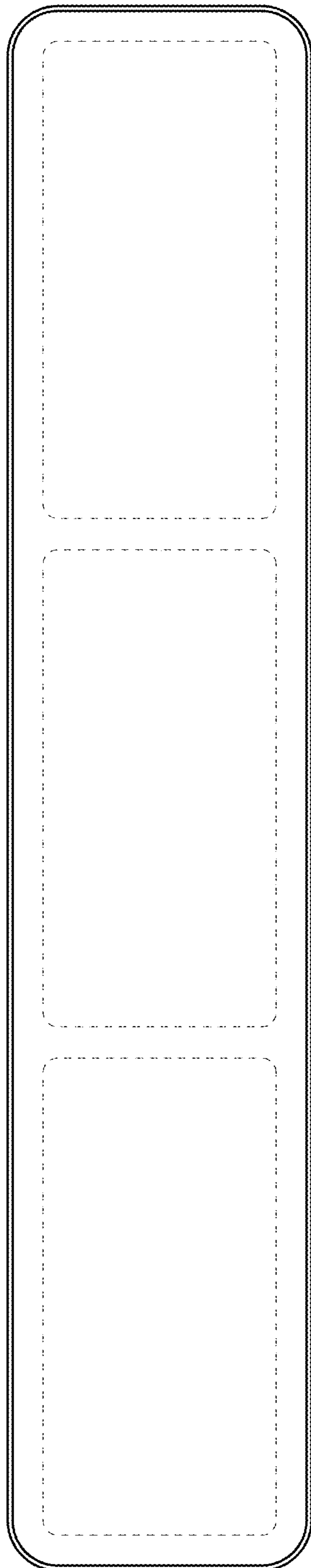

FIG. 6

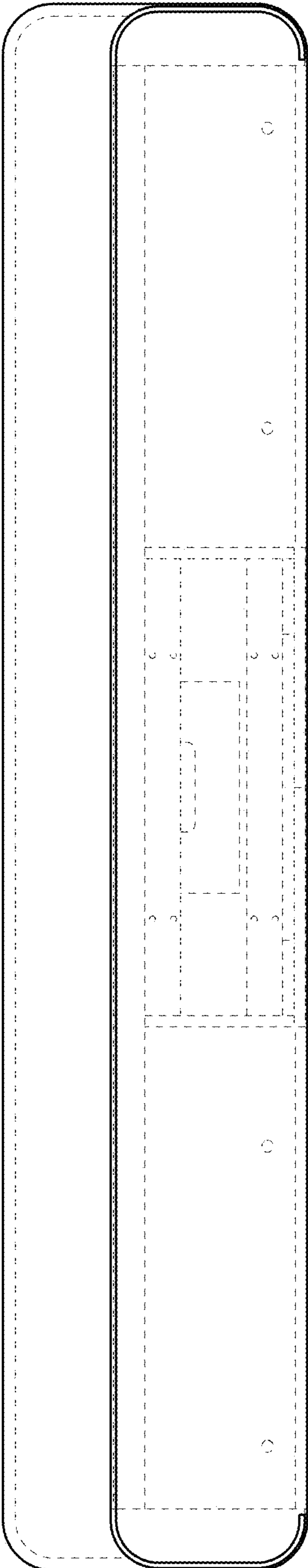

FIG. 7

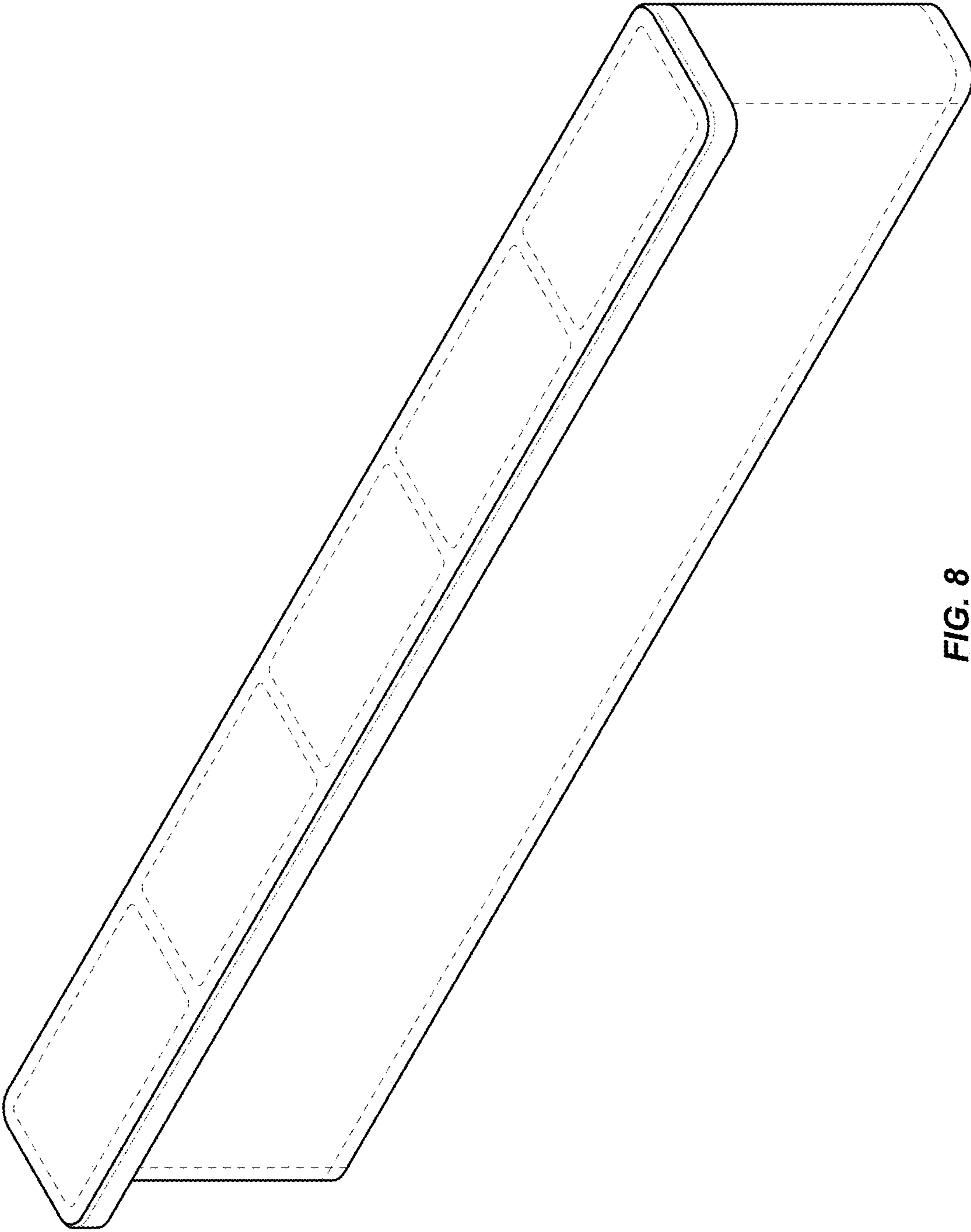

FIG. 8

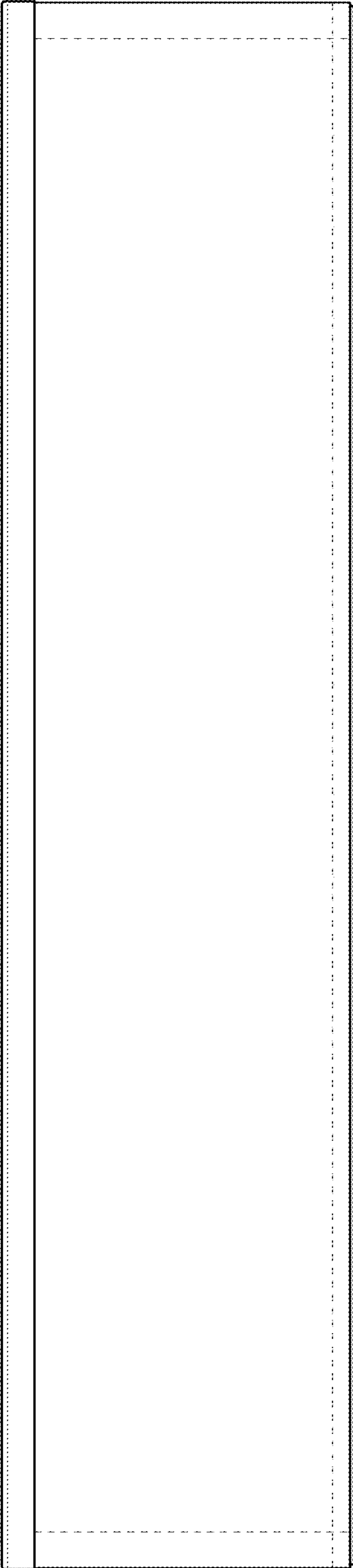

FIG. 9

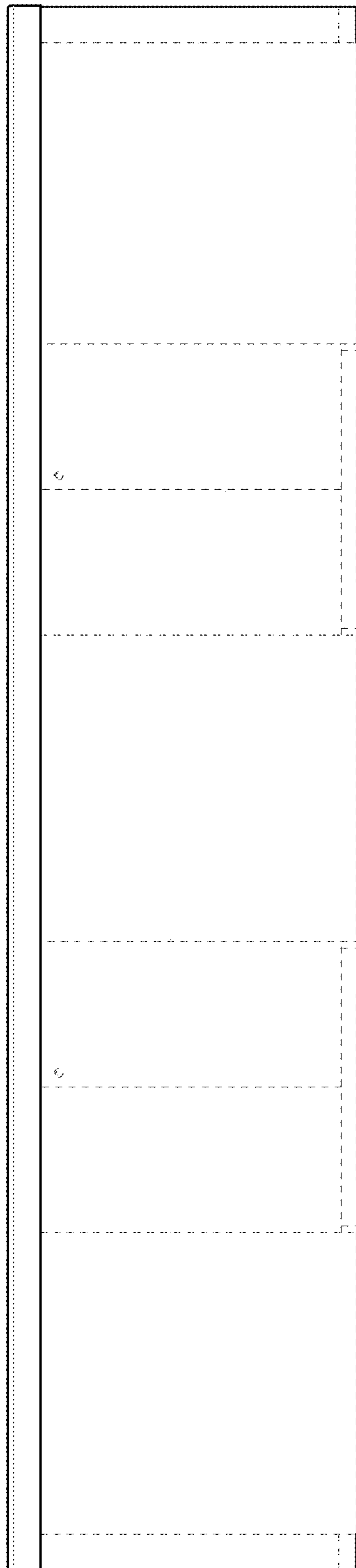

FIG. 10

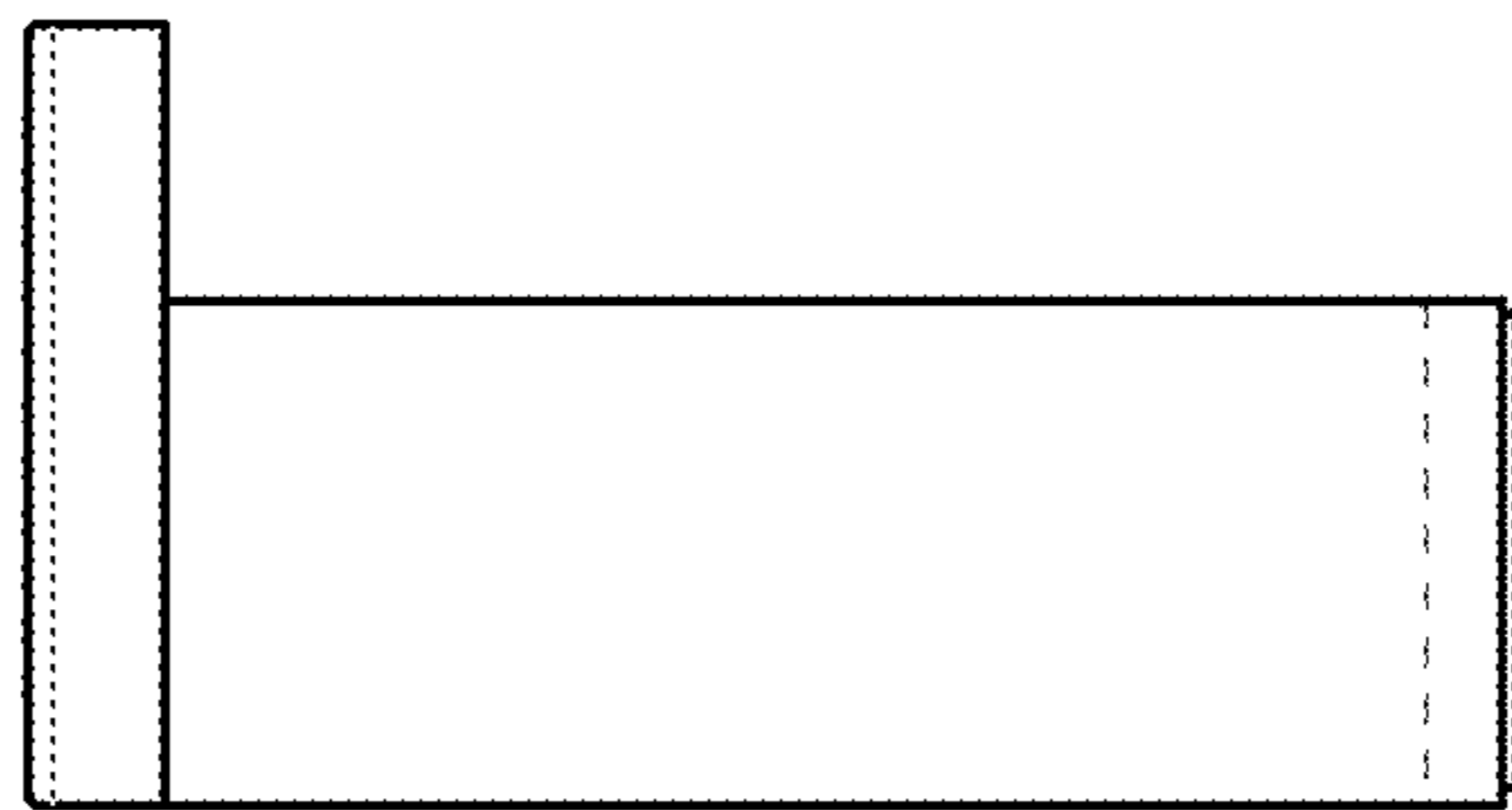

FIG. 11

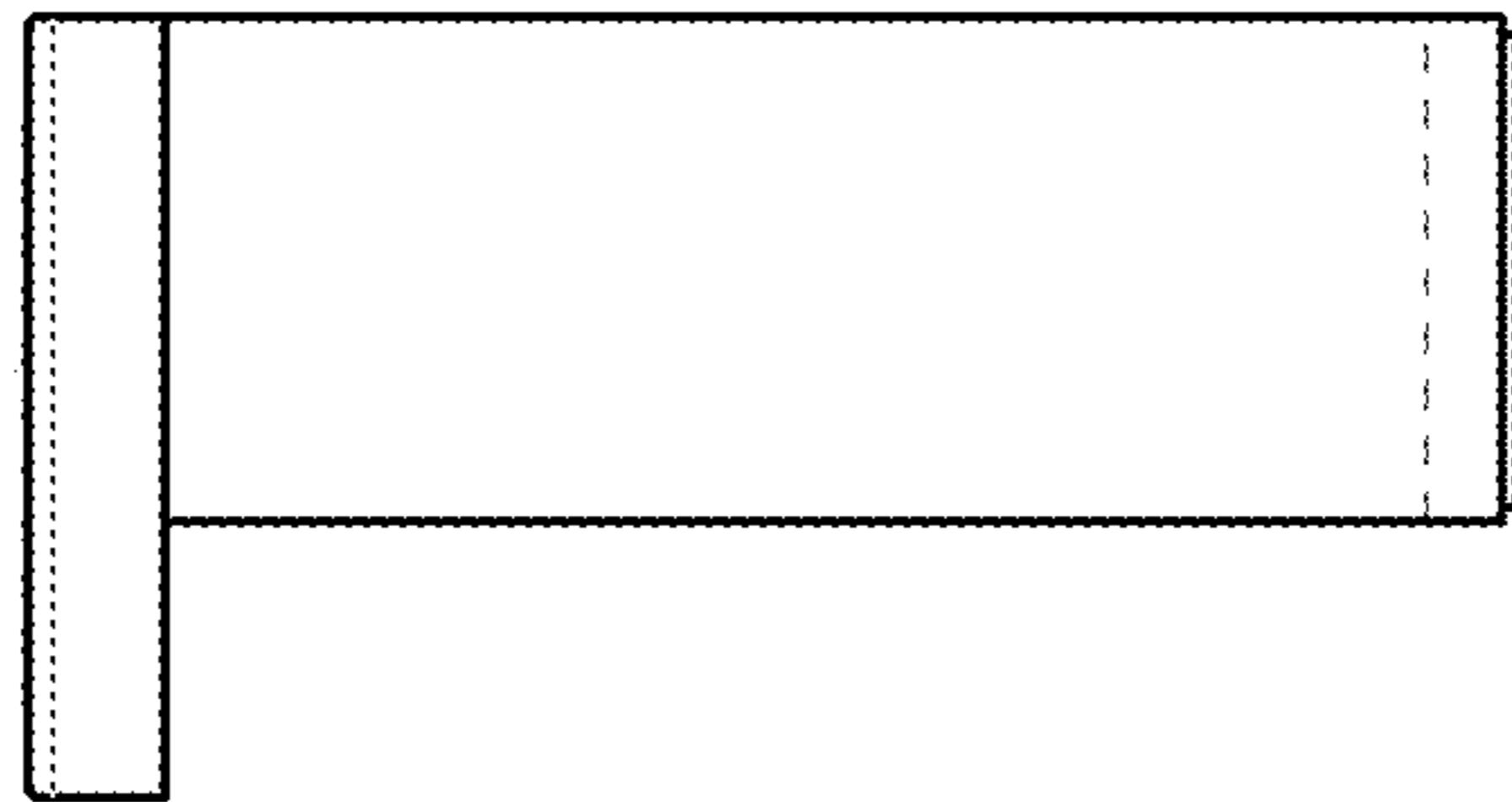

FIG. 12

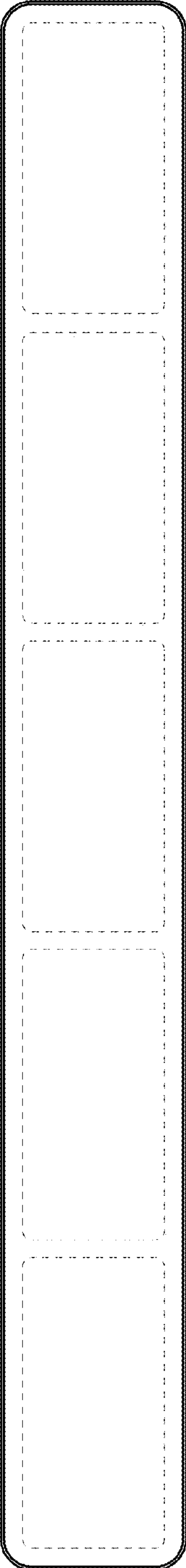

FIG. 13

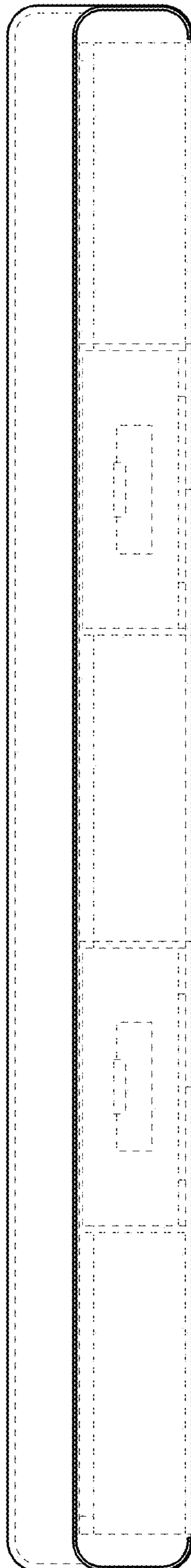

FIG. 14