

US00D917914S

(12) **United States Design Patent** (10) **Patent No.:** **US D917,914 S**
Deng (45) **Date of Patent:** **** May 4, 2021**

(54) **LAP DESK**
(71) Applicant: **Xiang Deng**, Shenzhen (CN)
(72) Inventor: **Xiang Deng**, Shenzhen (CN)
(**) Term: **15 Years**
(21) Appl. No.: **29/719,678**
(22) Filed: **Jan. 7, 2020**
(51) **LOC (13) Cl.** **06-06**
(52) **U.S. Cl.**
USPC **D6/406.5**
(58) **Field of Classification Search**
USPC D6/406.1, 406.2, 406.3, 406.5, 406.6,
D6/512, 685-686, 691, 704, 705;
D7/500, 550.1, 552.1, 552.2, 554.3, 555
CPC A47G 23/06; A47G 23/08; A47G 23/0608;
A47G 29/093; A47B 13/08; A47B 23/00;
A47B 23/002
See application file for complete search history.

D609,027 S * 2/2010 Jennings D6/406.5
D619,823 S * 7/2010 Jennings D6/406.3
D653,873 S * 2/2012 Chauss D6/406.3
D663,546 S * 7/2012 Jennings D6/406.3
D794,974 S * 8/2017 Jennings D6/406.3
D831,373 S * 10/2018 Wilson D6/406.3
D836,937 S * 1/2019 Sullins D6/406.3
D843,752 S * 3/2019 Sullins D6/406.5
D848,757 S * 5/2019 Kelly D6/406.3
D853,147 S * 7/2019 Chen D6/406.5
D856,701 S * 8/2019 Flanagan D6/406.3
D887,166 S * 6/2020 Ren D6/406.5

* cited by examiner

Primary Examiner — Kelley A Donnelly
(74) *Attorney, Agent, or Firm* — Rumit Ranjit Kanakia

(57) **CLAIM**

I claim the ornamental design for a lap desk, as shown and described.

DESCRIPTION

FIG. 1 is a Perspective view of a lap desk showing my new design;
FIG. 2 is a Front view thereof;
FIG. 3 is a Back view thereof;
FIG. 4 is a Right-side view thereof;
FIG. 5 is a Top view thereof; and,
FIG. 6 is a Bottom view thereof.
The broken lines in the figures illustrate portions of the lap desk that form no part of the claimed design.

1 Claim, 6 Drawing Sheets

(56) **References Cited**
U.S. PATENT DOCUMENTS
D308,450 S * 6/1990 Harris D6/406.6
5,081,936 A * 1/1992 Drieling B60N 3/002
108/25
D331,330 S * 12/1992 Bennett D6/406.3
D353,276 S * 12/1994 Foran D19/113
D354,187 S * 1/1995 Daukus D6/406.3
D467,933 S * 12/2002 Hovsepian D14/458
D526,810 S * 8/2006 Lorr D6/406.5
D575,077 S * 8/2008 Kessels D6/406.3

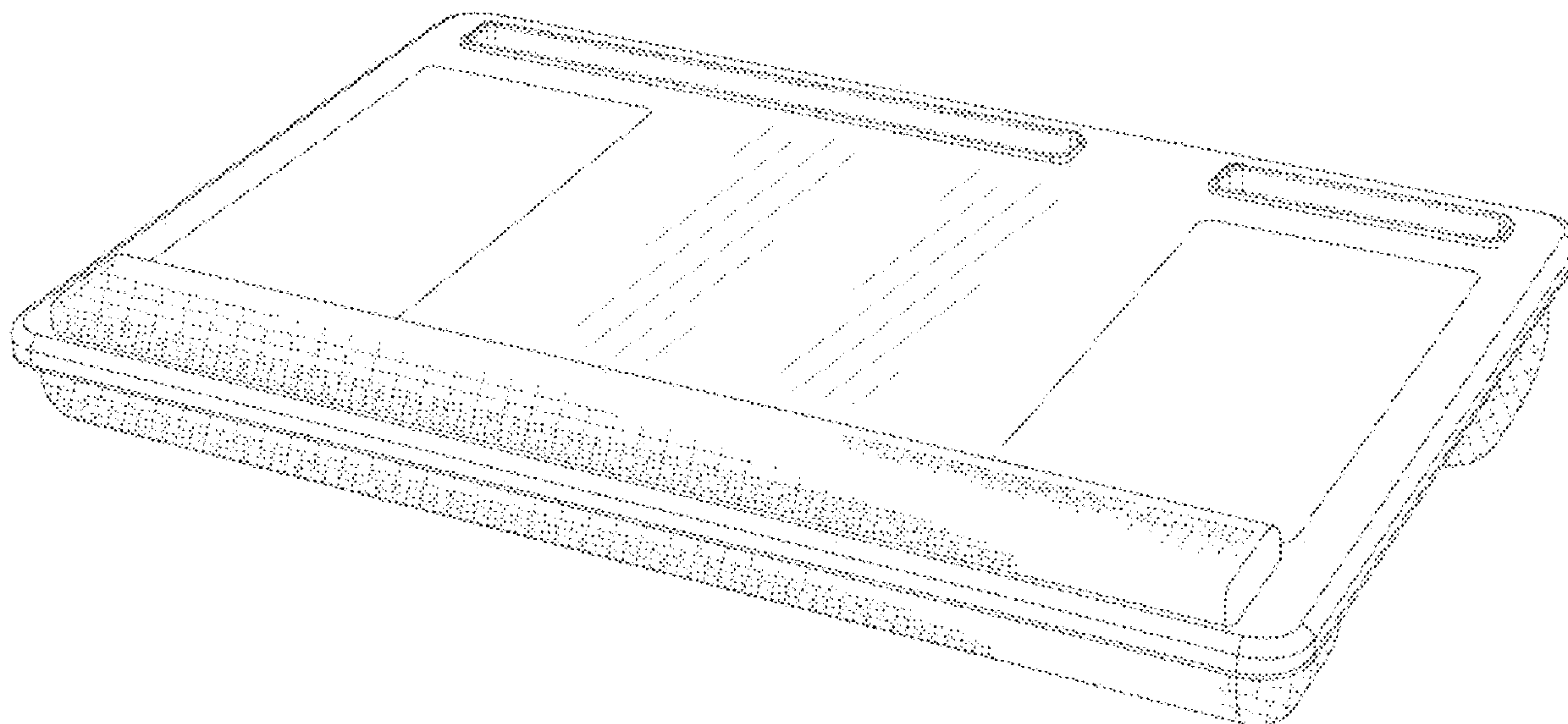

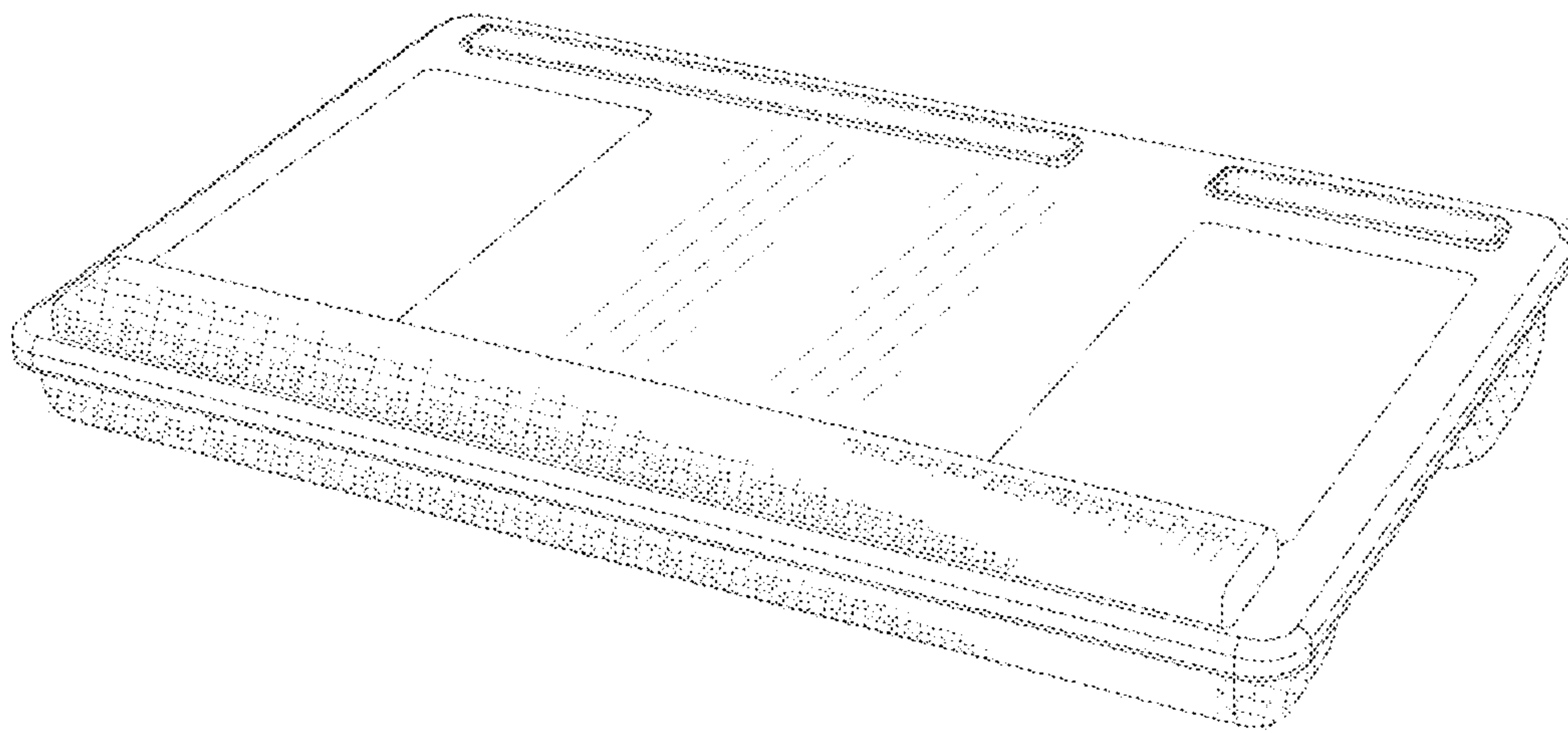

FIG. 1

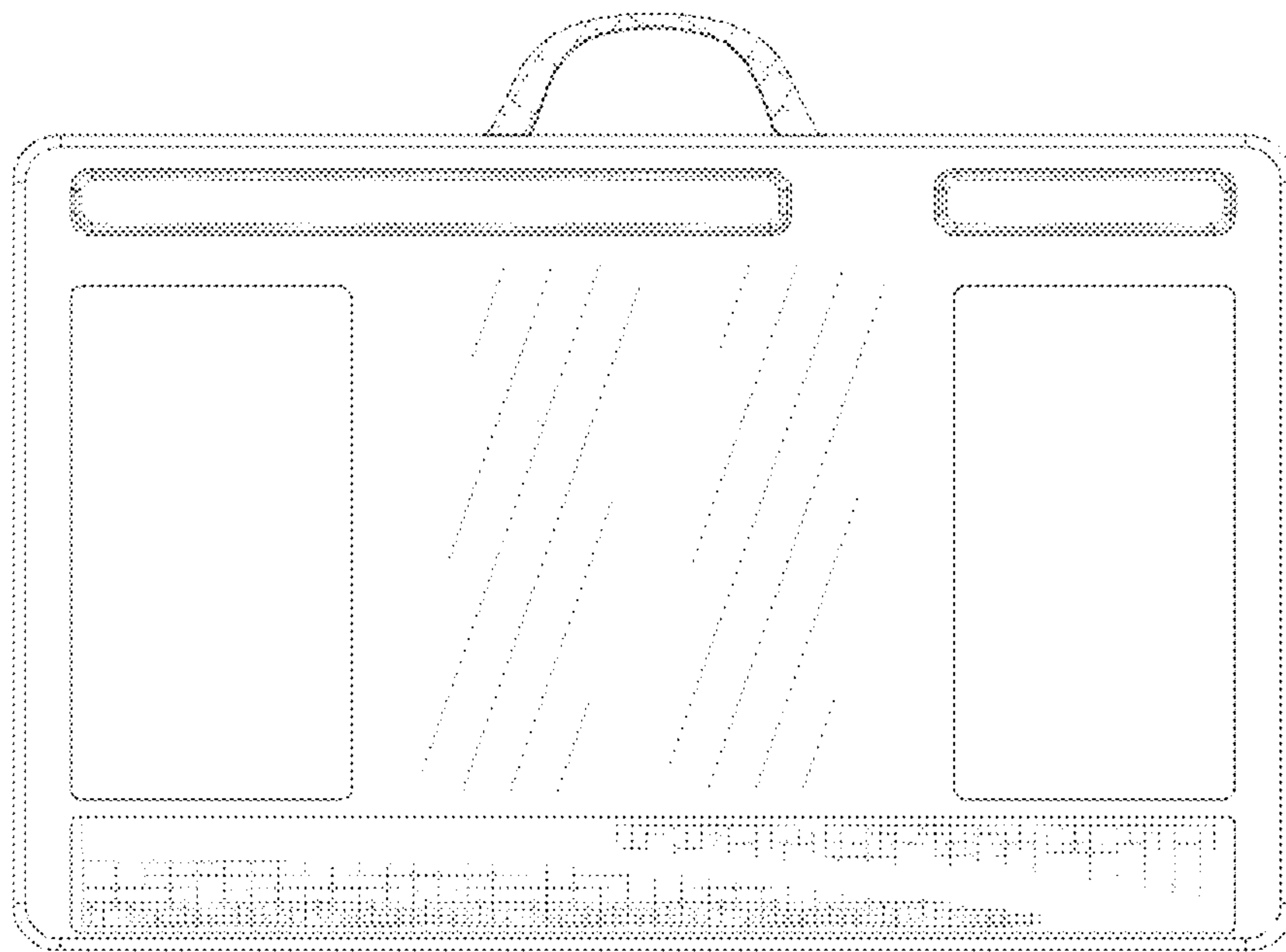

FIG. 2

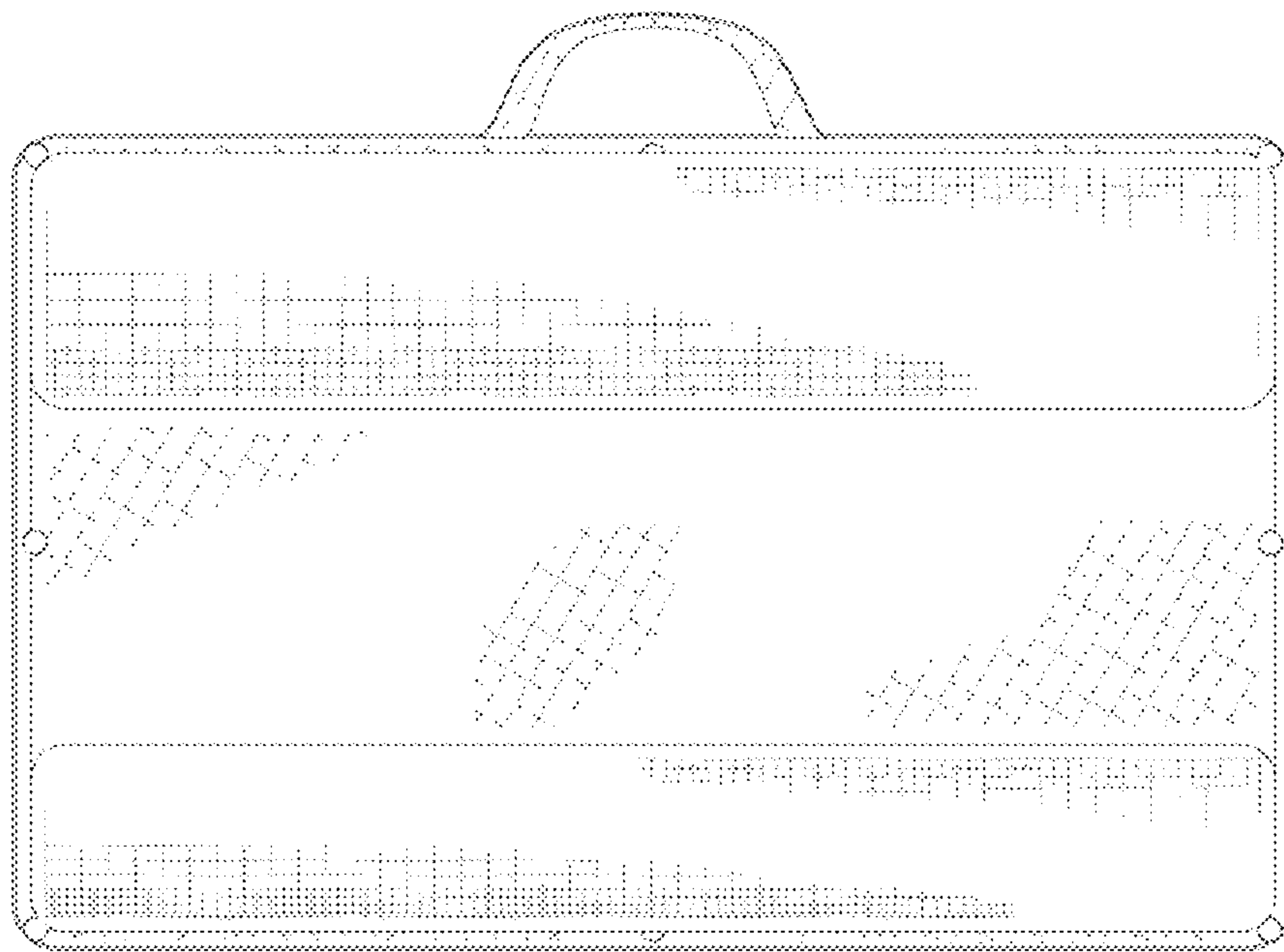

FIG. 3

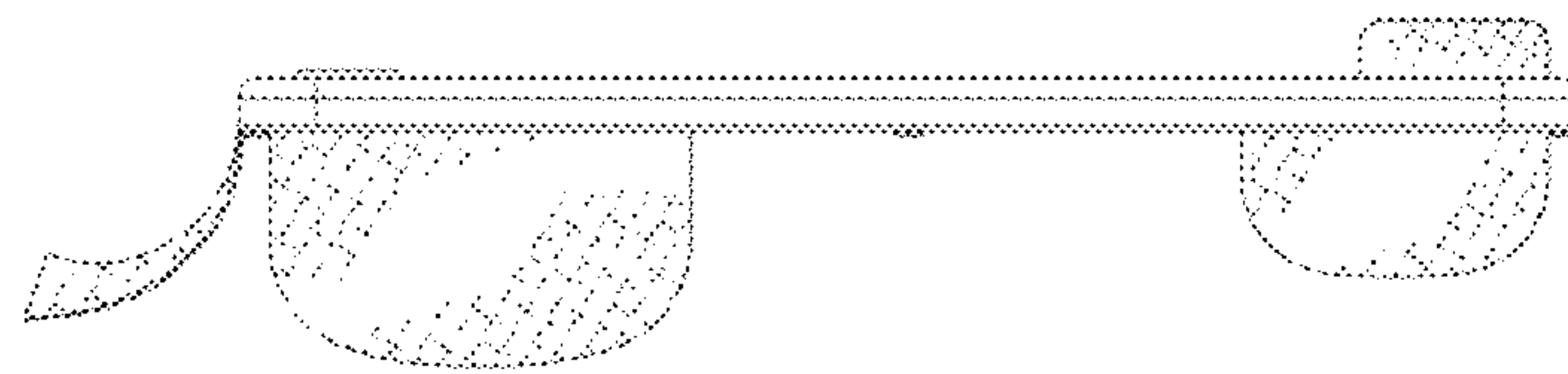

FIG. 4

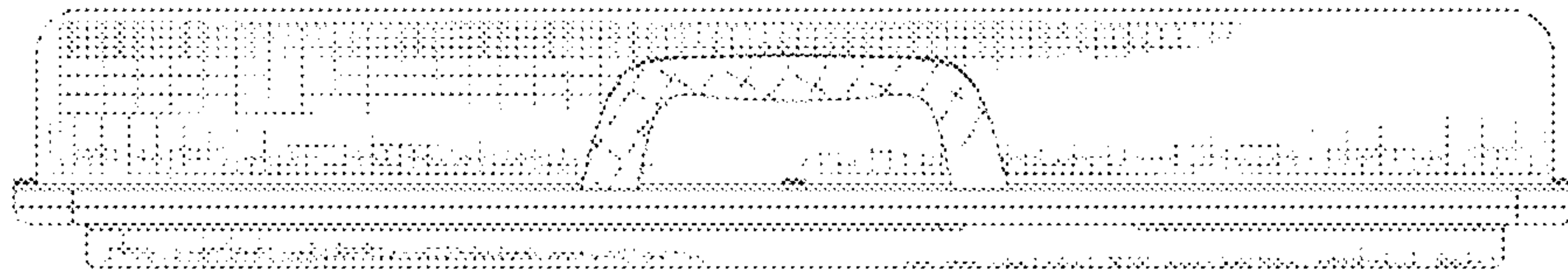

FIG. 5

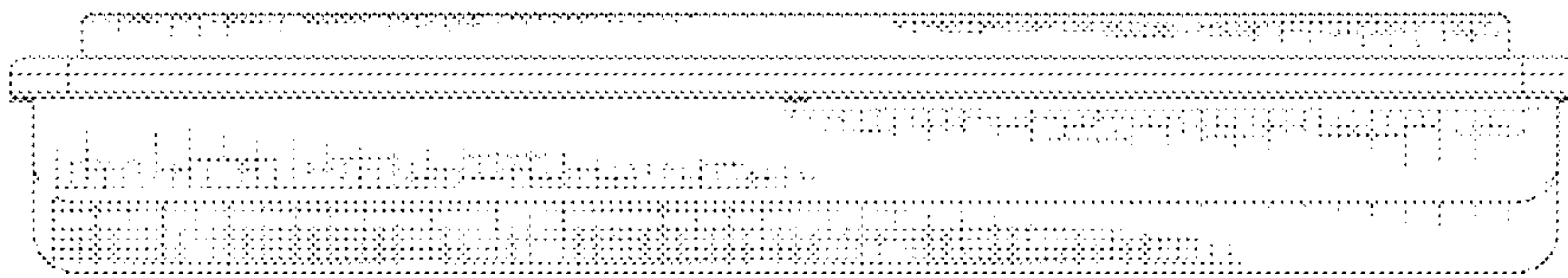

FIG. 6