



US00D917863S

(12) **United States Design Patent**
McMillan

(10) **Patent No.:** **US D917,863 S**

(45) **Date of Patent:** **** May 4, 2021**

(54) **SHOE**

(71) Applicant: **NIKE, Inc.**, Beaverton, OR (US)

(72) Inventor: **Graeme McMillan**, Portland, OR (US)

(73) Assignee: **NIKE, Inc.**, Beaverton, OR (US)

(**) Term: **15 Years**

(21) Appl. No.: **29/720,228**

(22) Filed: **Jan. 10, 2020**

(51) **LOC (13) Cl.** **02-04**

(52) **U.S. Cl.**

USPC **D2/972**

(58) **Field of Classification Search**

USPC D2/896, 902, 904, 906-908, 969,
D2/972-974

CPC ... A43B 13/181; A43B 13/141; A43B 13/186;
A43B 13/188; A43B 23/26; A43B 1/04;
A43B 23/00; A43B 5/00

See application file for complete search history.

(56) **References Cited**

U.S. PATENT DOCUMENTS

D375,617 S	11/1996	Orzeck	
D475,516 S *	6/2003	Laberge	D2/972
D499,871 S	12/2004	Teteriatnikov	
D675,008 S	1/2013	VanHook	
D681,932 S	5/2013	Parrett	
D752,329 S	3/2016	Kirschner	
D771,916 S *	11/2016	Helwig	D2/916
D796,165 S *	9/2017	Helwig	D2/916
D827,281 S *	9/2018	Buscemi	D2/972
D838,095 S *	1/2019	McMillan	D2/972
D845,604 S *	4/2019	Hernandez	D2/972
D897,087 S *	9/2020	Matthews	D2/972
2017/0071774 A1 *	3/2017	Ostergard	A43B 5/00
2019/0365022 A1 *	12/2019	Linkfield	A43B 7/12

OTHER PUBLICATIONS

Jordan Crater posted by Nike posted date unknown, © Nike, [online], [site visited Dec. 20, 2020]. Available from Internet, <https://www.nike.com/t/jordan-crater-shoe-B3fHB5/CT0712-001> (Year: 2020).*

“The Nike Air Footscape “No Cover” Goes Punk With Zebra Patterns”; Sneaker News; retrieved Jan. 2, 2020; published Oct. 25, 2019; URL: <<https://sneakernews.com/2019/10/25/olivia-kim-nike-air-footscape-ck3321-100-release-date/>>.

Bred Air Jordan 11 Is Returning Next Month; sole collector; retrieved Jan. 2, 2020; published Nov. 14, 2019; URL: <<https://solecollector.com/news/2019/11/air-jordan-11-xi-bred-2019-release-date-378037-061>>.

* cited by examiner

Primary Examiner — Cynthia Ramirez

Assistant Examiner — Laura H Yu

(74) *Attorney, Agent, or Firm* — Banner & Witcoff, Ltd.

(57) **CLAIM**

The ornamental design for a shoe, as shown and described.

DESCRIPTION

FIG. 1 is a front perspective view of a shoe showing my new design;

FIG. 2 is a side view thereof;

FIG. 3 is a rear perspective view thereof;

FIG. 4 is a rear view thereof;

FIG. 5 is an opposite side rear perspective view thereof;

FIG. 6 is an opposite side view thereof; and,

FIG. 7 is an opposite side front perspective view thereof.

The broken lines depicting the remainder of the shoe form no part of the claimed design.

1 Claim, 7 Drawing Sheets

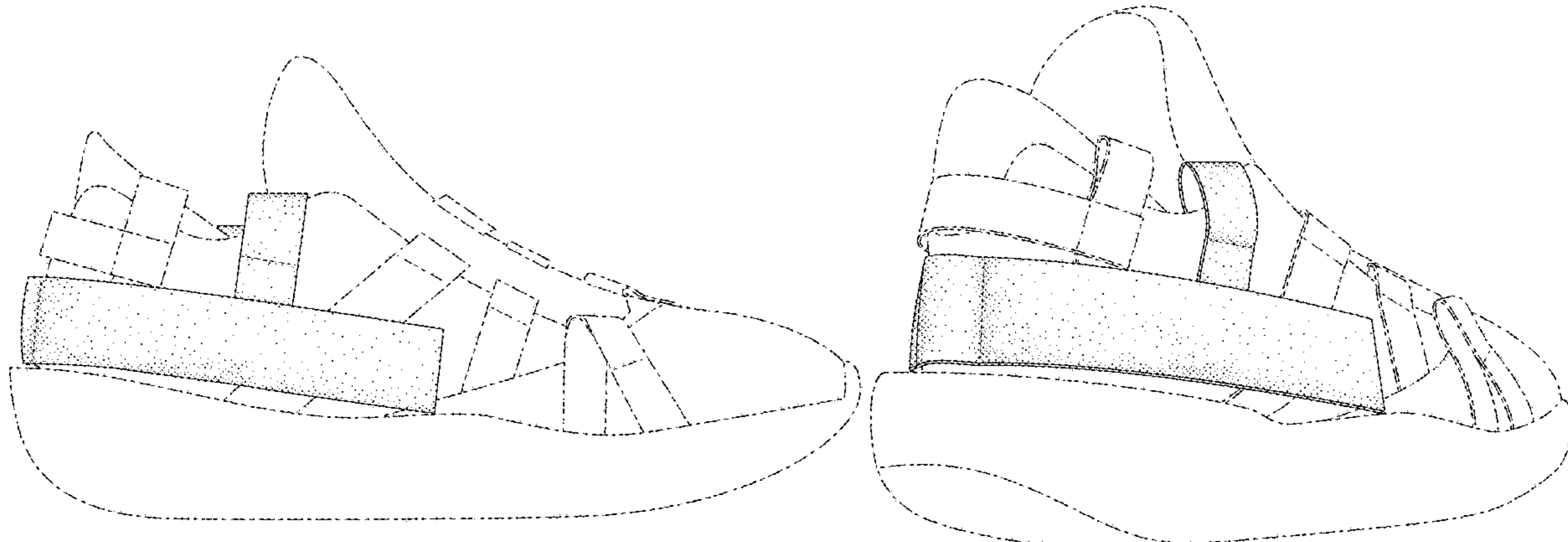

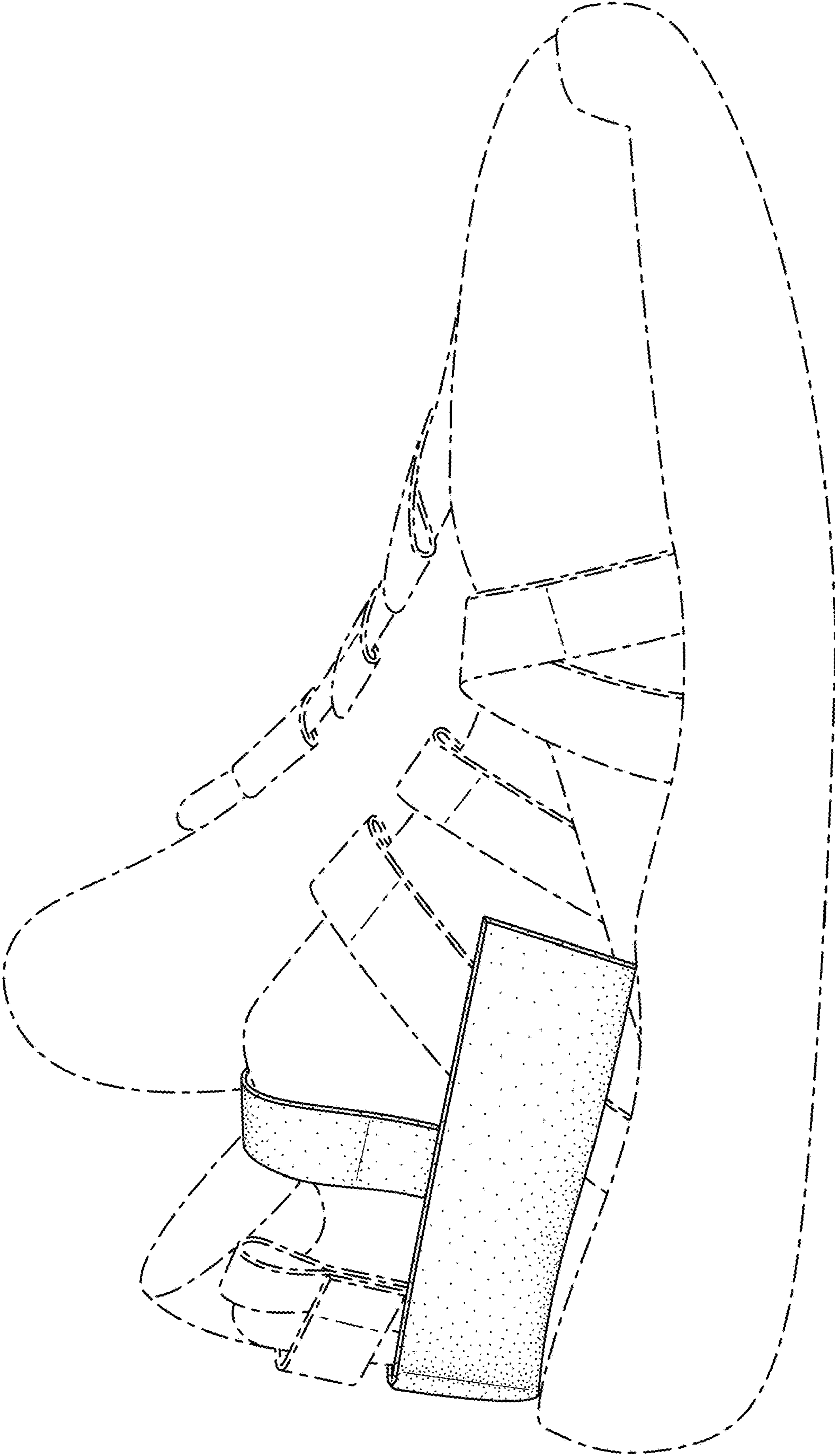

FIG. 1

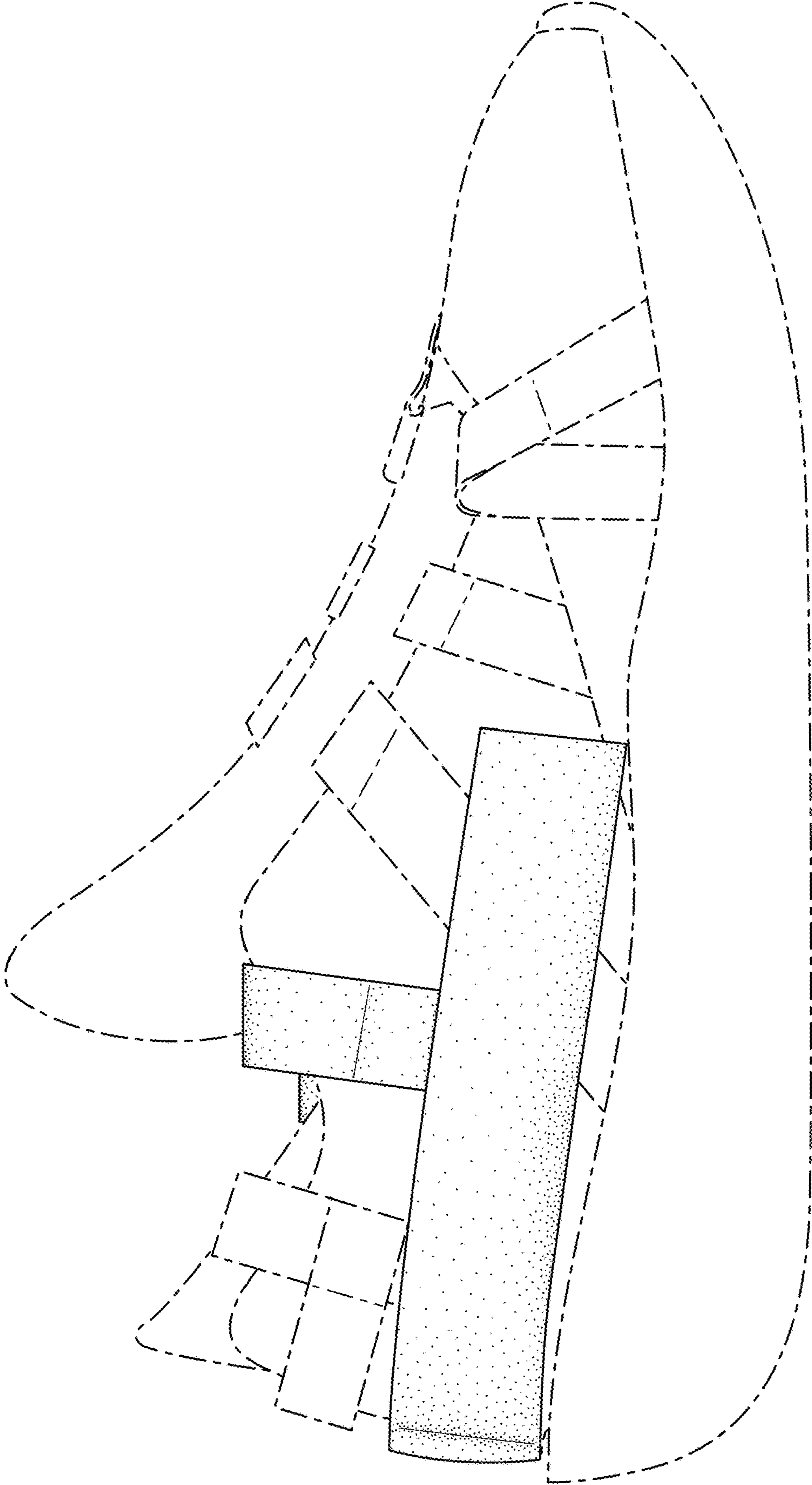

FIG. 2

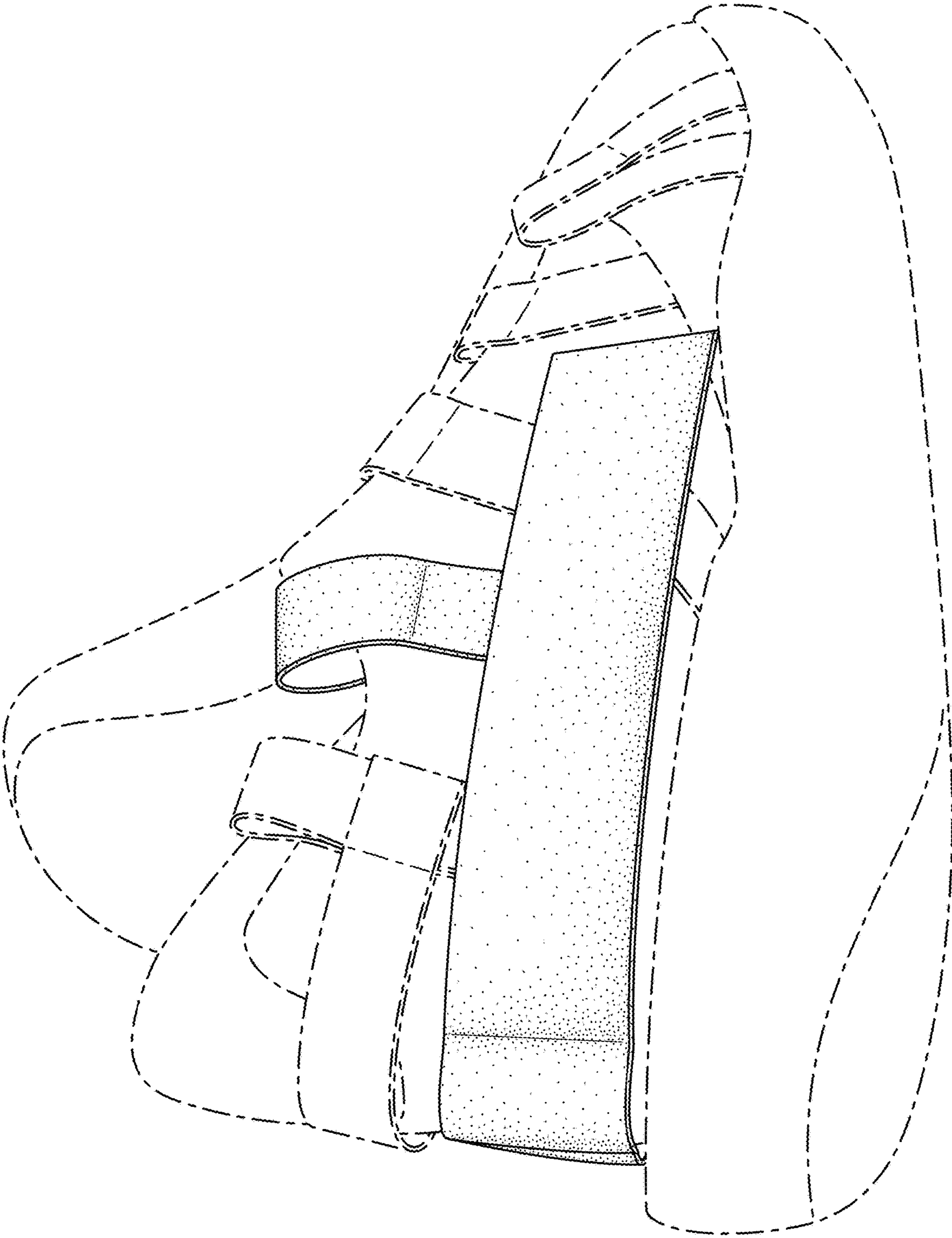

FIG. 3

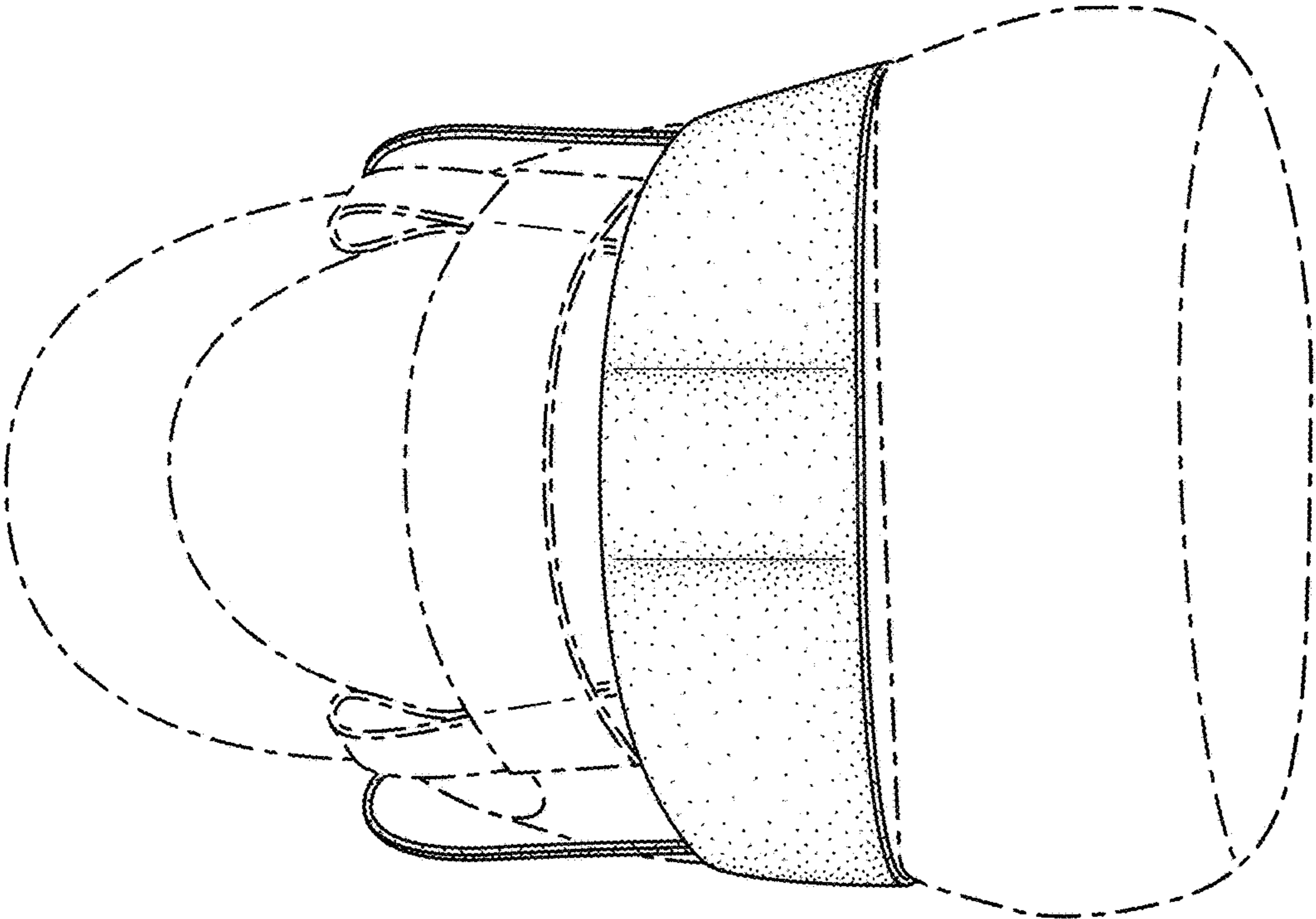

FIG. 4

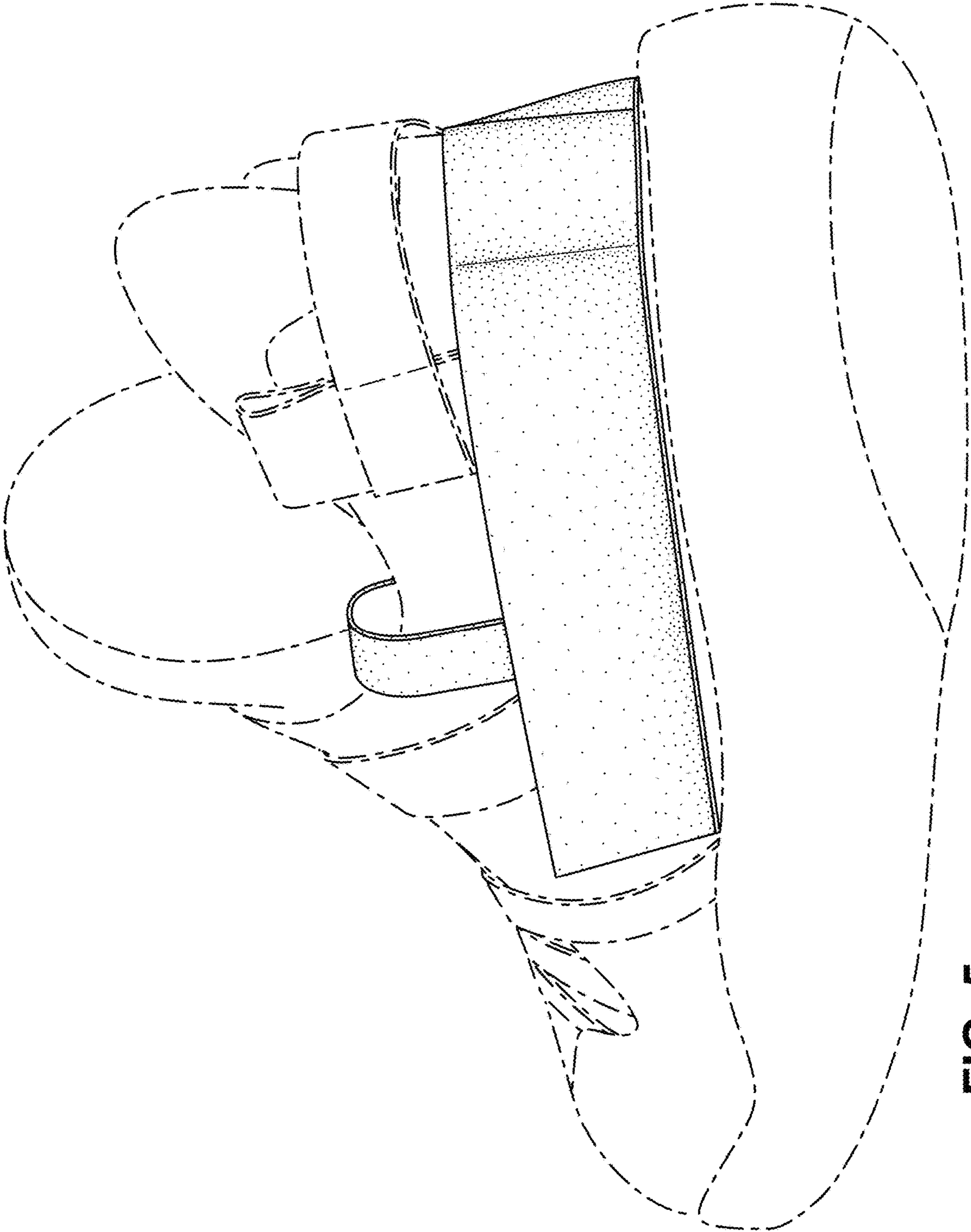

FIG. 5

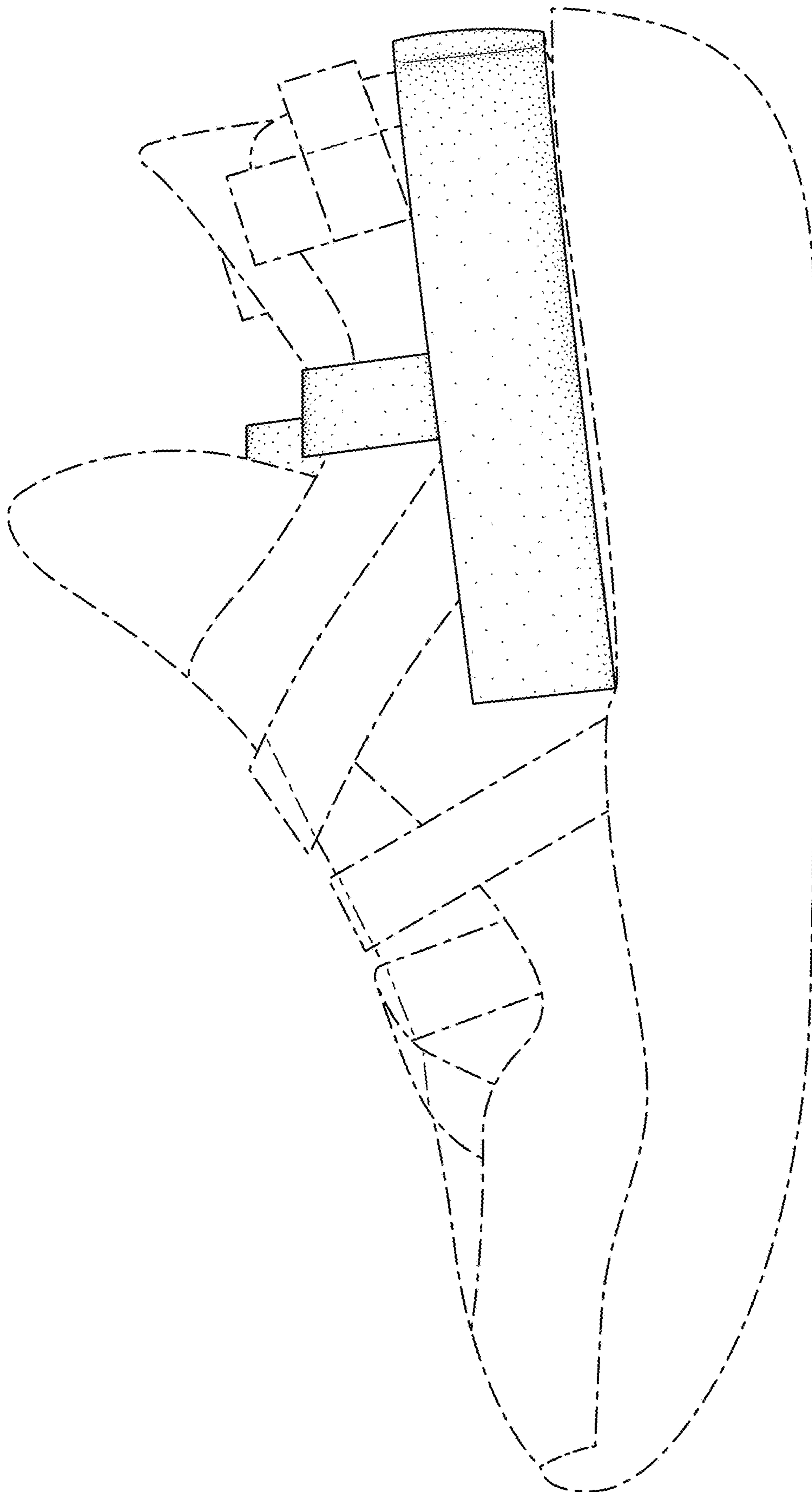

FIG. 6

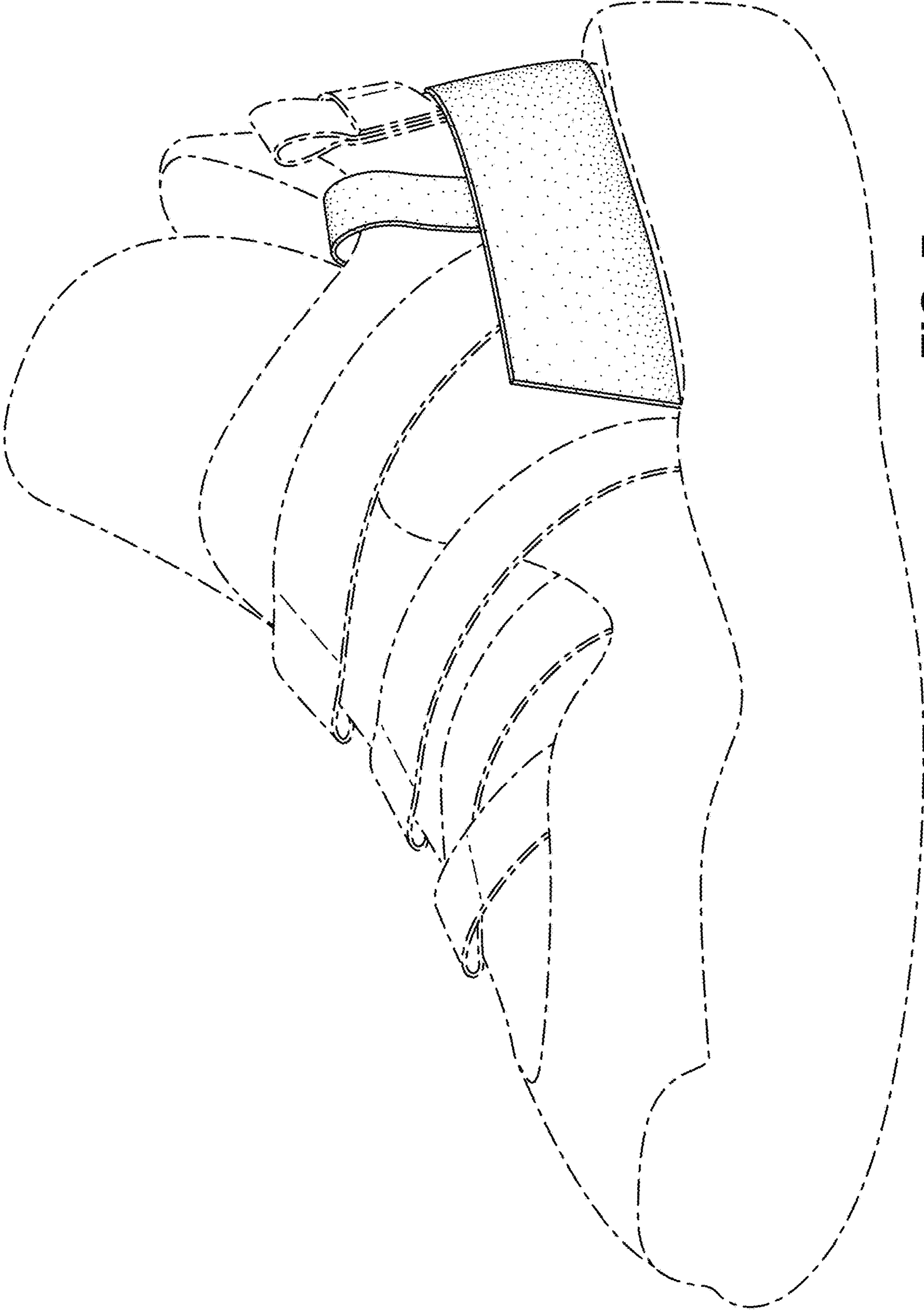

FIG. 7