



US00D917646S

(12) **United States Design Patent**
Chen

(10) **Patent No.:** **US D917,646 S**

(45) **Date of Patent:** **** Apr. 27, 2021**

(54) **RECTANGULAR TRAMPOLINE FRAME**

(71) Applicant: **Samuel Chen**, Hong Kong (CN)

(72) Inventor: **Samuel Chen**, Hong Kong (CN)

(**) Term: **15 Years**

(21) Appl. No.: **29/707,301**

(22) Filed: **Sep. 27, 2019**

(51) **LOC (13) Cl.** **21-02**

(52) **U.S. Cl.**
USPC **D21/797**

(58) **Field of Classification Search**
USPC D21/671, 672, 686, 797, 692, 693, 835
CPC A63B 71/00; A63B 71/022; A63B 5/11;
A63B 71/0054; A63B 71/02
See application file for complete search history.

(56) **References Cited**

U.S. PATENT DOCUMENTS

3,004,623	A *	10/1961	Nissen	A63B 5/11	482/28
4,341,379	A *	7/1982	Milligan	A63B 5/11	482/28
D614,715	S *	4/2010	Mann	D21/797	
D676,093	S *	2/2013	Kulzer	D21/694	
8,585,557	B2 *	11/2013	Ikegami	A63B 71/022	482/27
D799,626	S *	10/2017	Chen	D21/797	
2007/0021272	A1 *	1/2007	Slade	A63B 5/11	482/27
2009/0062078	A1 *	3/2009	VanElverdinghe	A63B 5/11	482/29

2010/0285926	A1 *	11/2010	Ikegami	A63B 67/002	482/27
2016/0030794	A1 *	2/2016	Yang	A63B 5/11	482/27
2018/0369629	A1 *	12/2018	Publicover	A63B 71/022	
2020/0238152	A1 *	7/2020	Hagel	A63B 71/022	

OTHER PUBLICATIONS

Upper bounce rectangular trampoline [online], [site visited Feb. 2, 2021]. Available from internet, URL: https://www.amazon.com/Upper-Bounce-Rectangular-Trampoline-Enclosure/dp/B00FLYAY3I/ref=sr_1_289?dchild=1&keywords=jumper+trampoline&qid=1612298871&sr=8-289 (Year: 2013).*

* cited by examiner

Primary Examiner — Khawaja Anwar
Assistant Examiner — Julice Seung Eun Oum
(74) *Attorney, Agent, or Firm* — Clement Cheng

(57) **CLAIM**

The ornamental design for a rectangular trampoline frame, as shown and described.

DESCRIPTION

FIG. 1 is a front perspective view.
FIG. 2 is a front view.
FIG. 3 is a back view.
FIG. 4 is a top view.
FIG. 5 is a bottom view.
FIG. 6 is a right view.
FIG. 7 is a left view; and,
FIG. 8 is a rear perspective view.

1 Claim, 8 Drawing Sheets

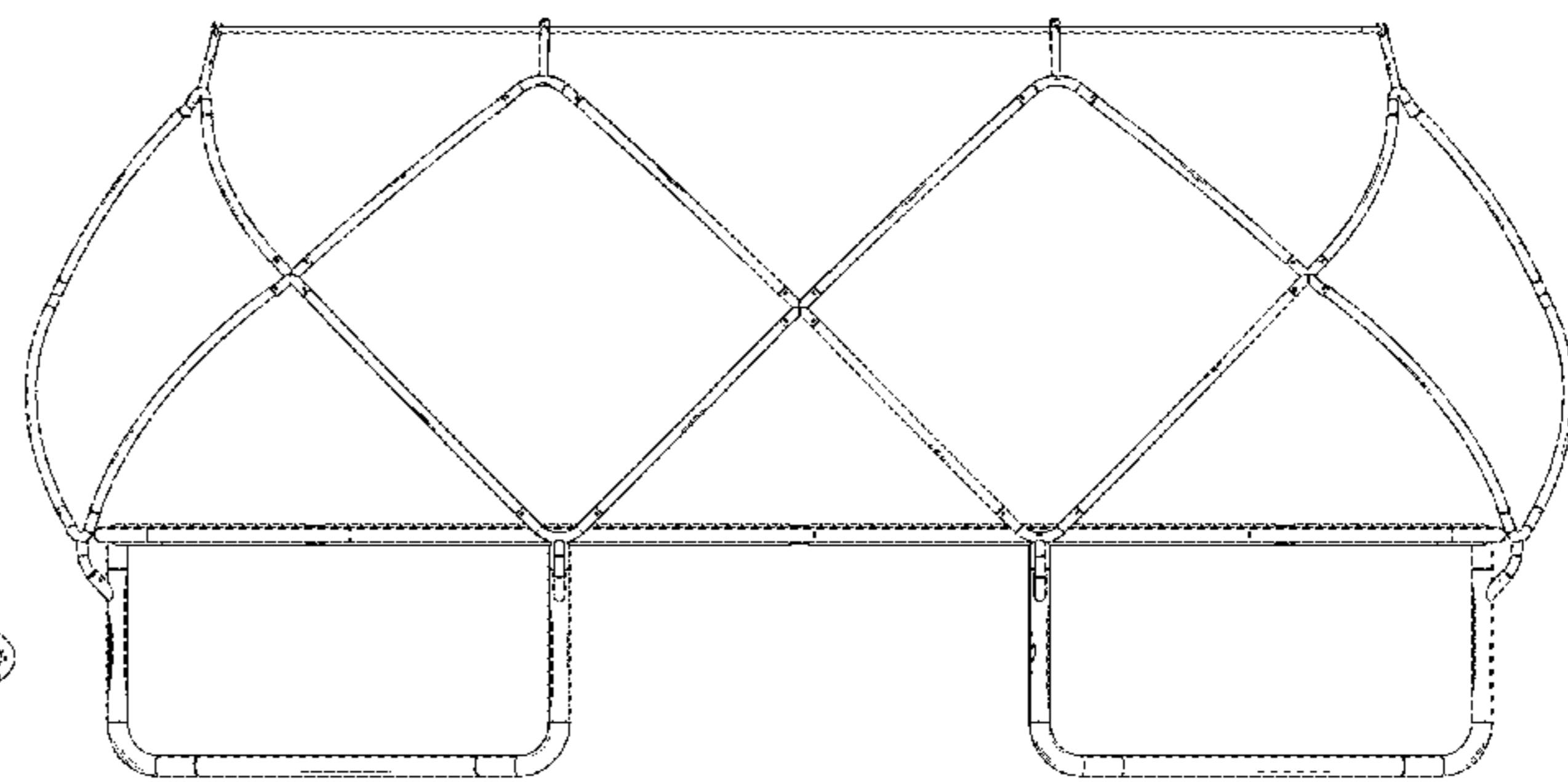
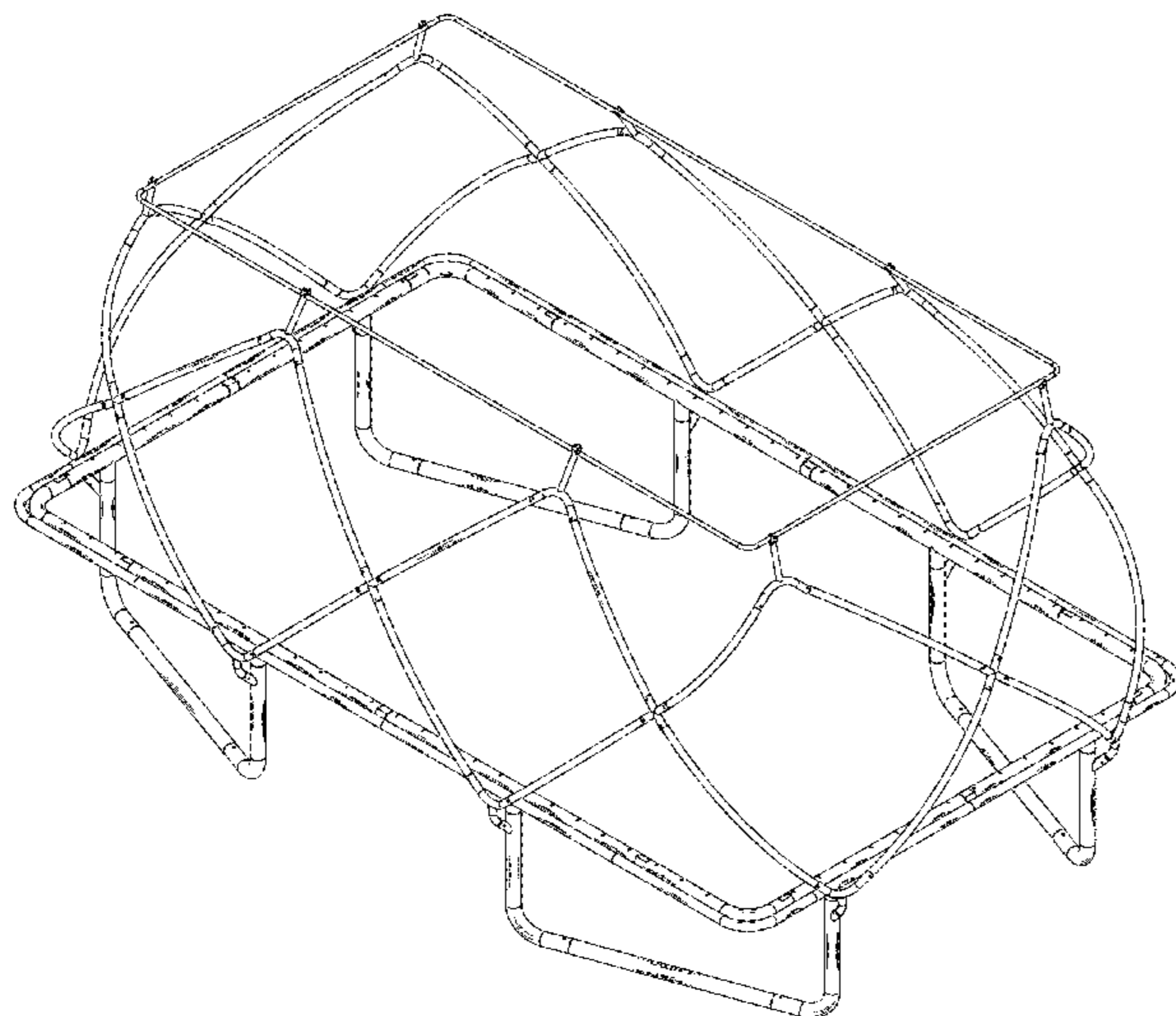

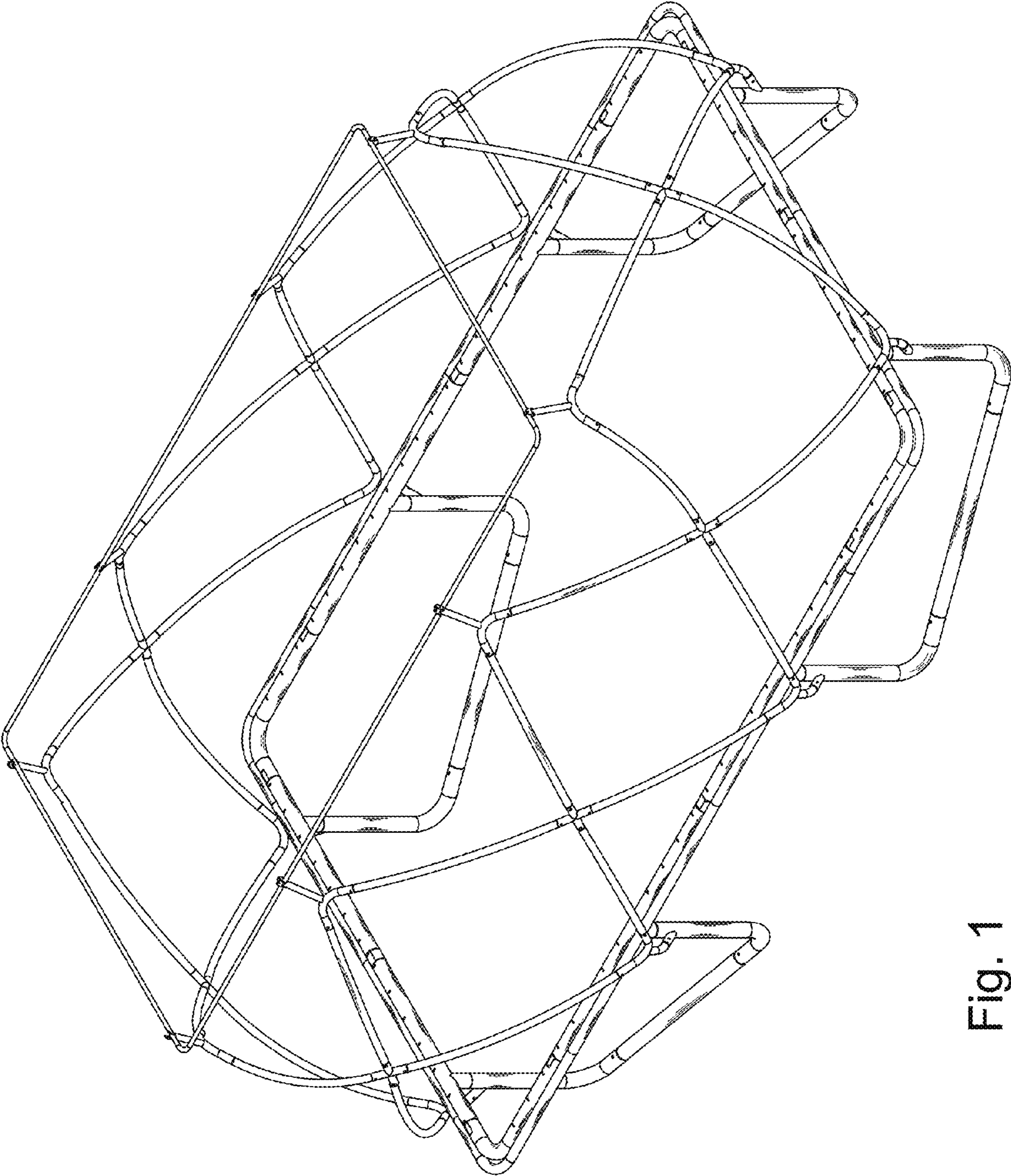

Fig. 1

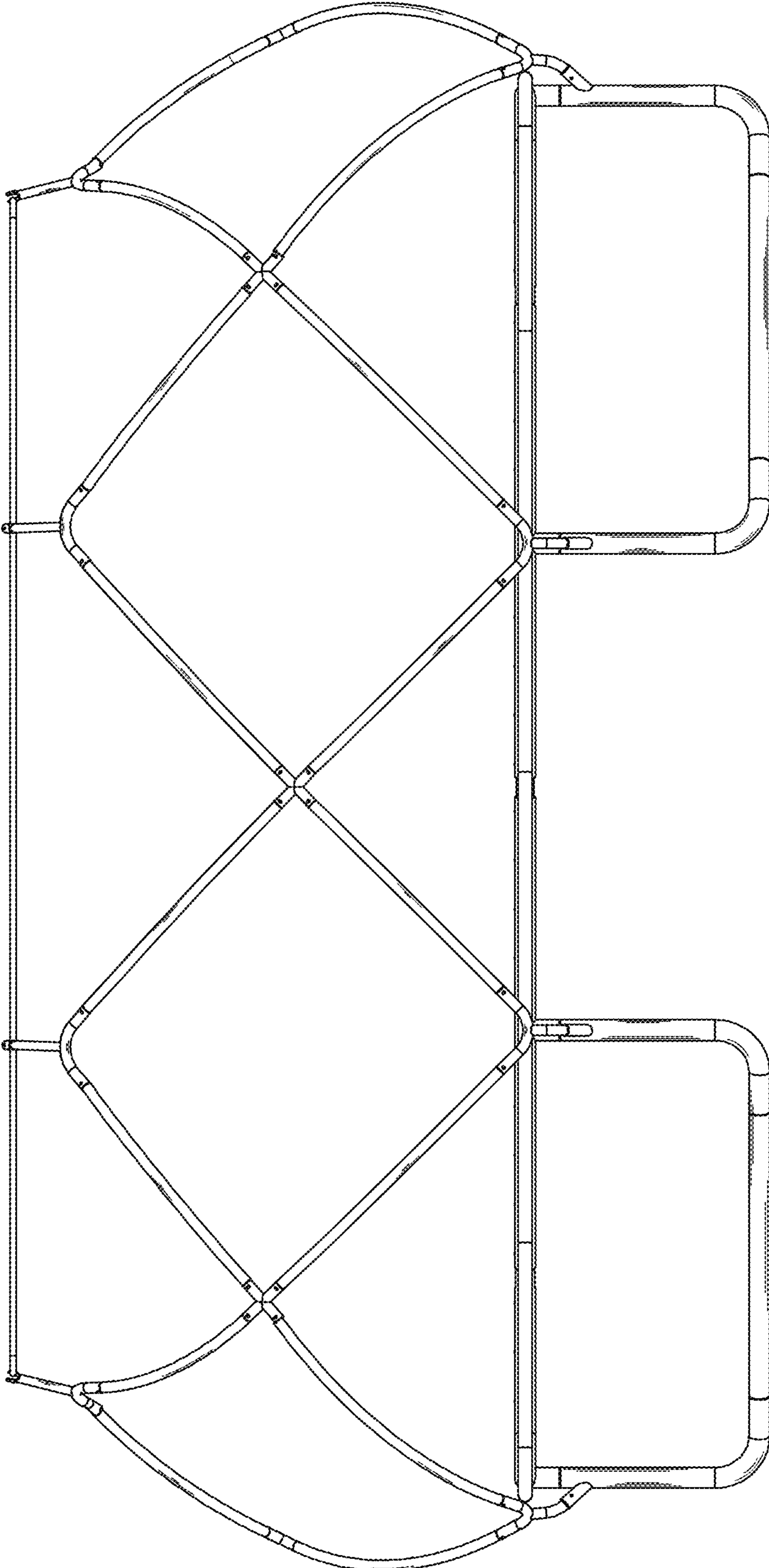

Fig. 2

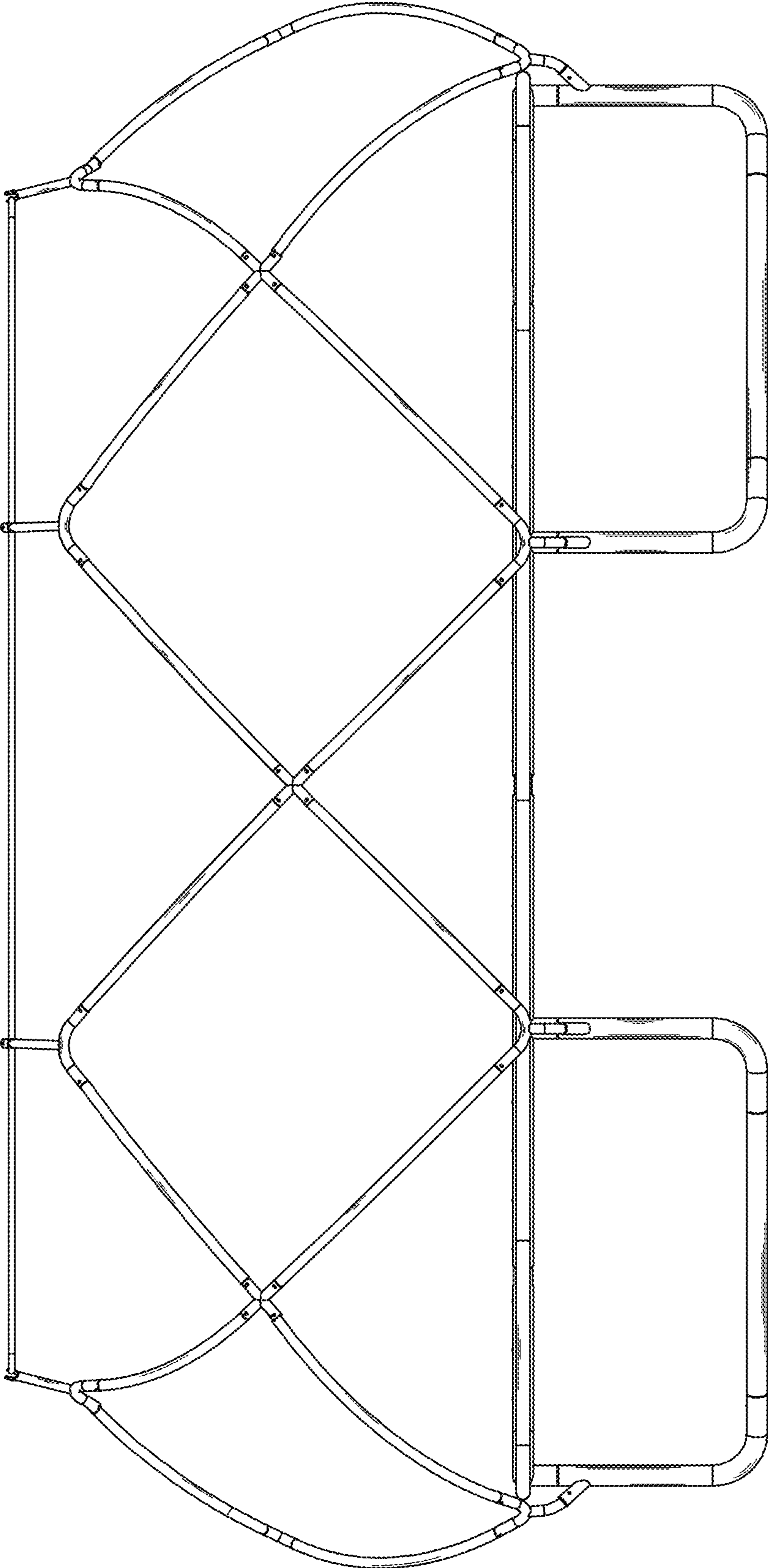

Fig. 3

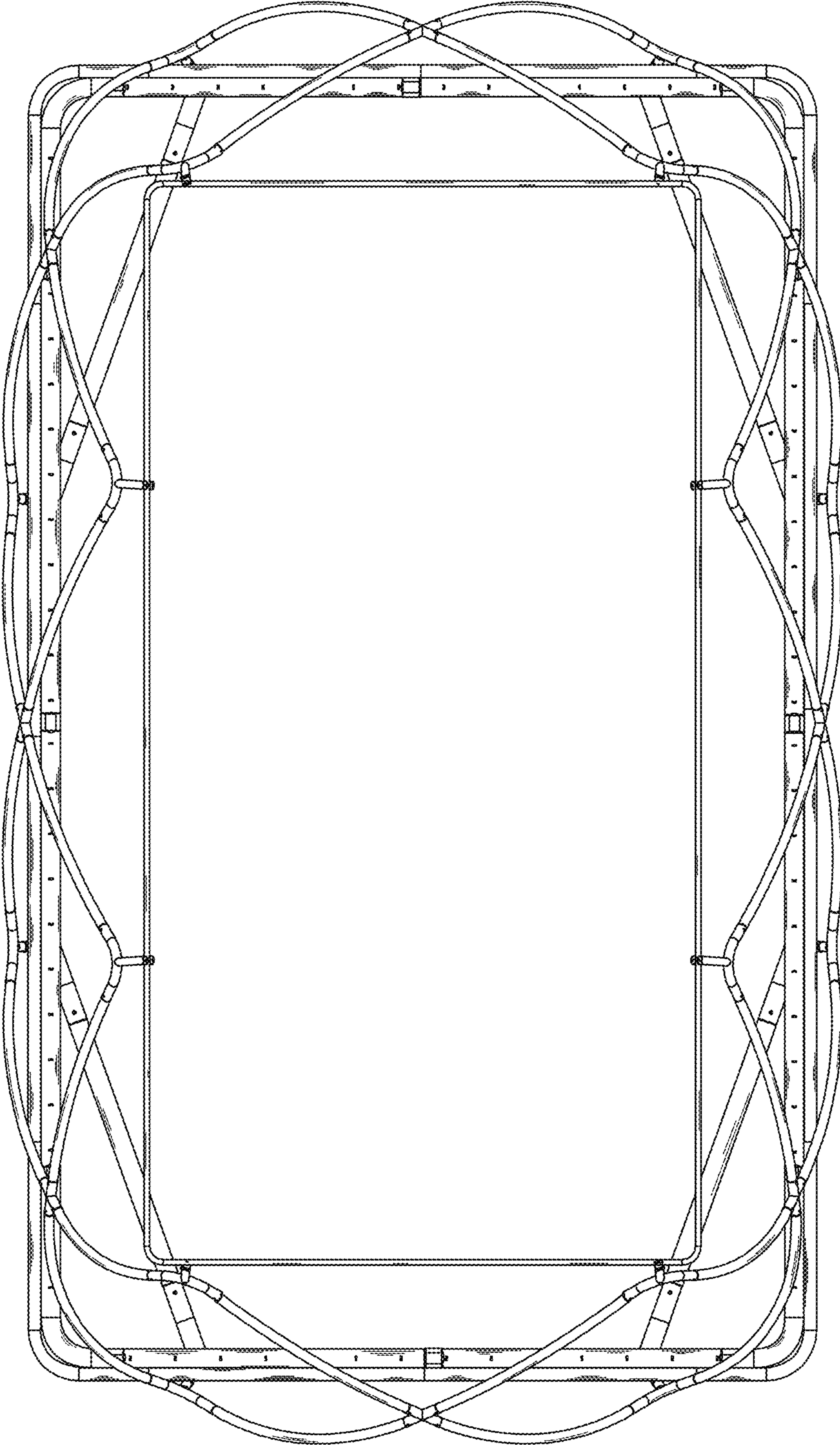

Fig. 4

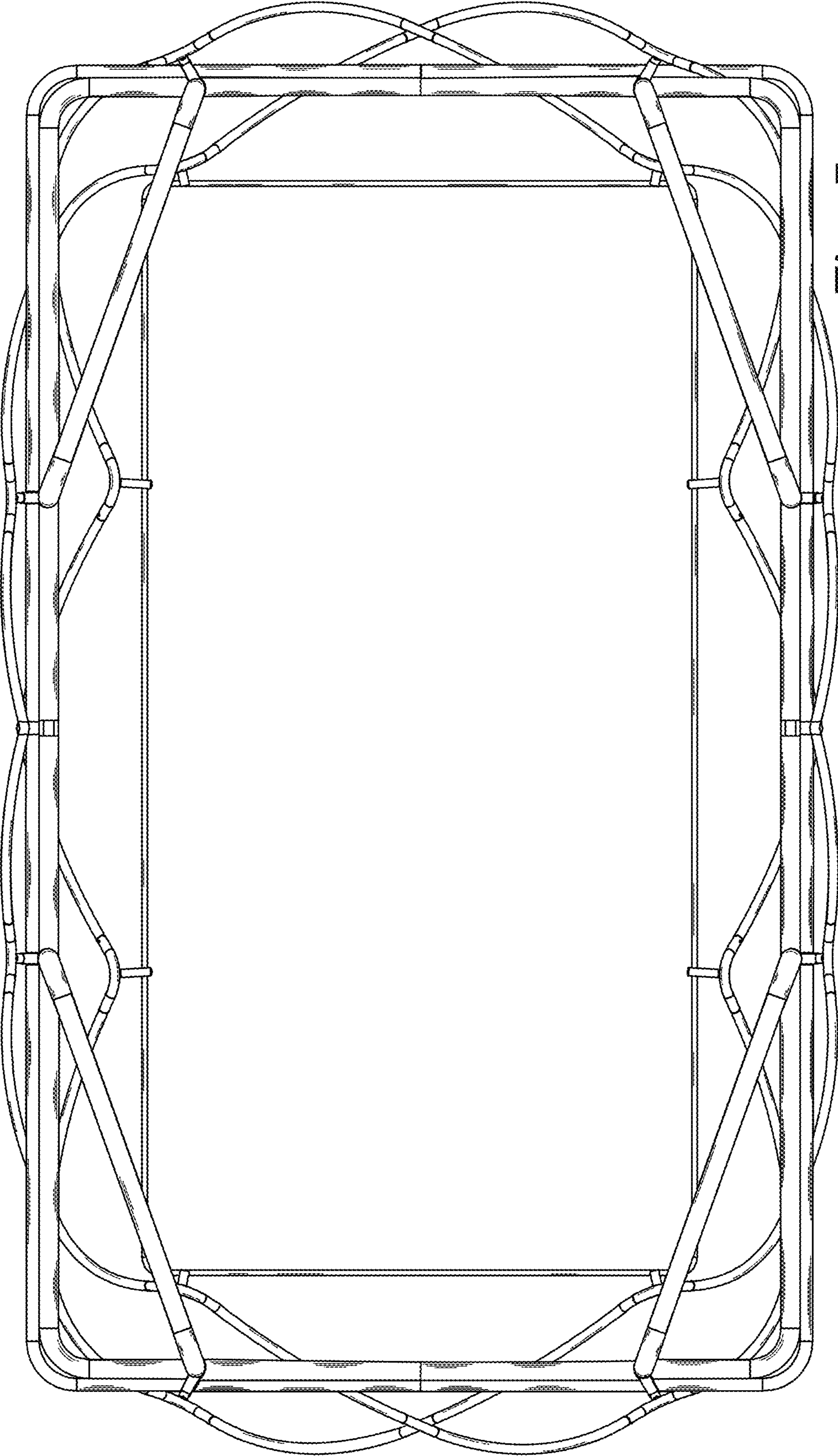

Fig. 5

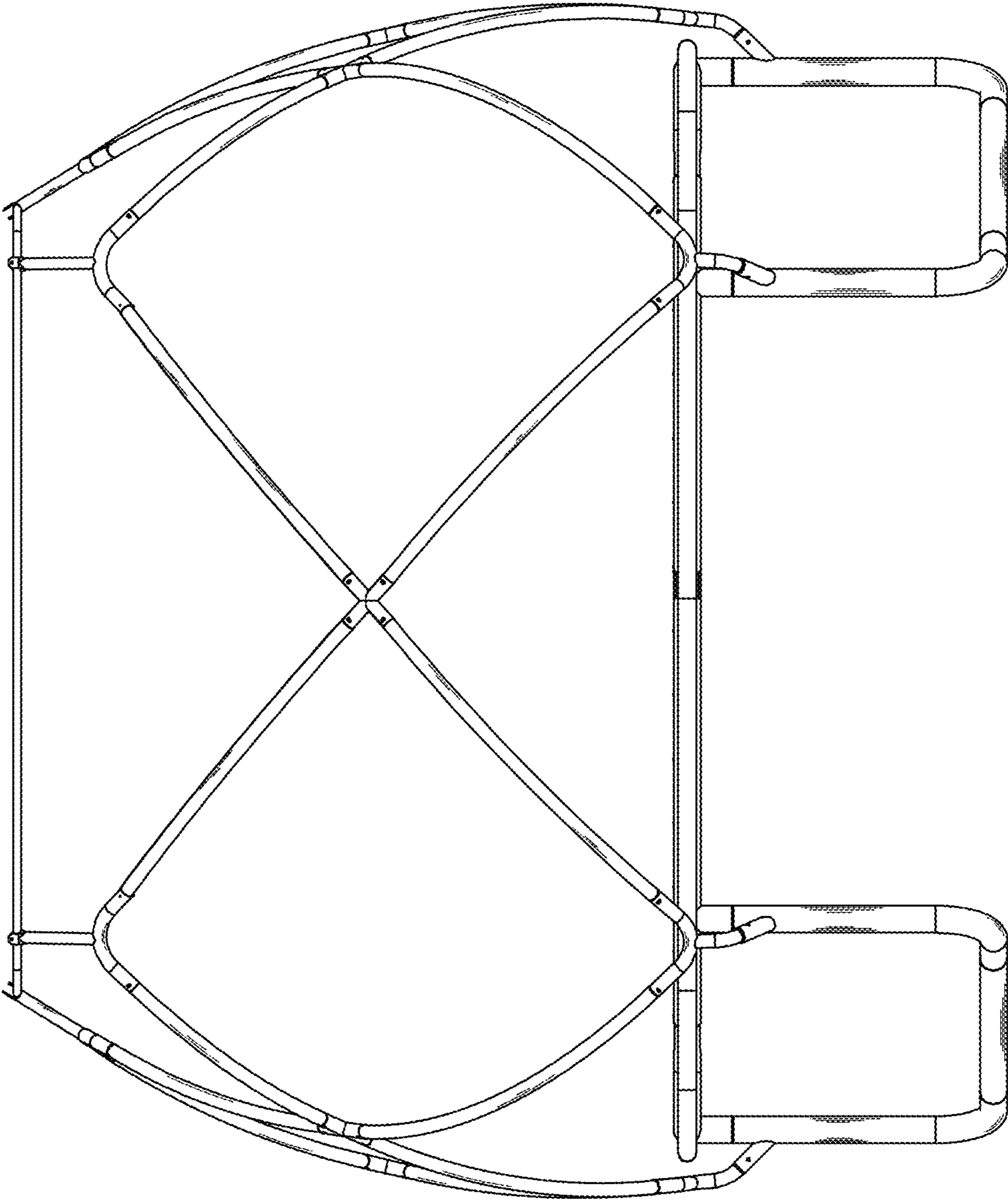

Fig. 6

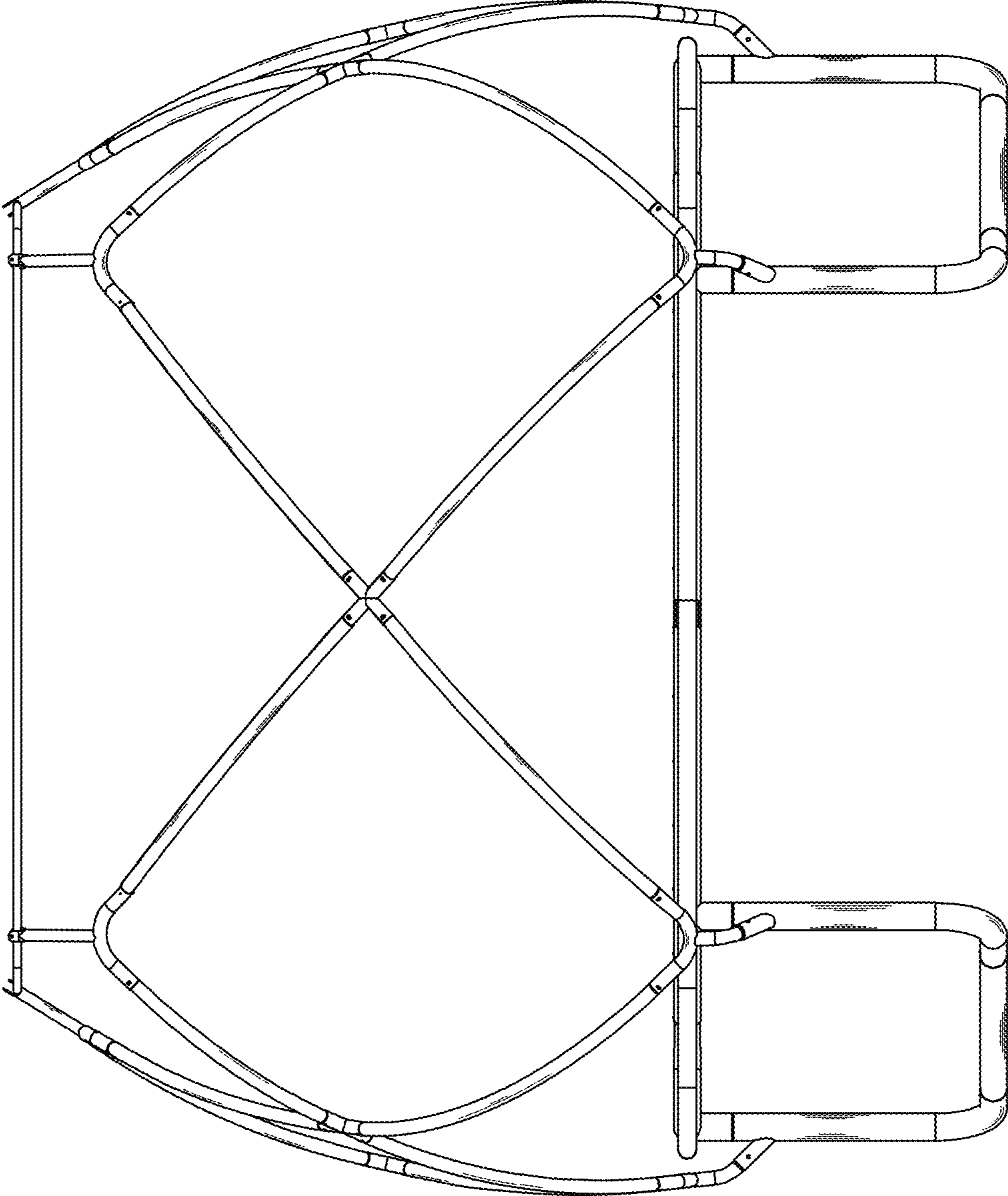

Fig. 7

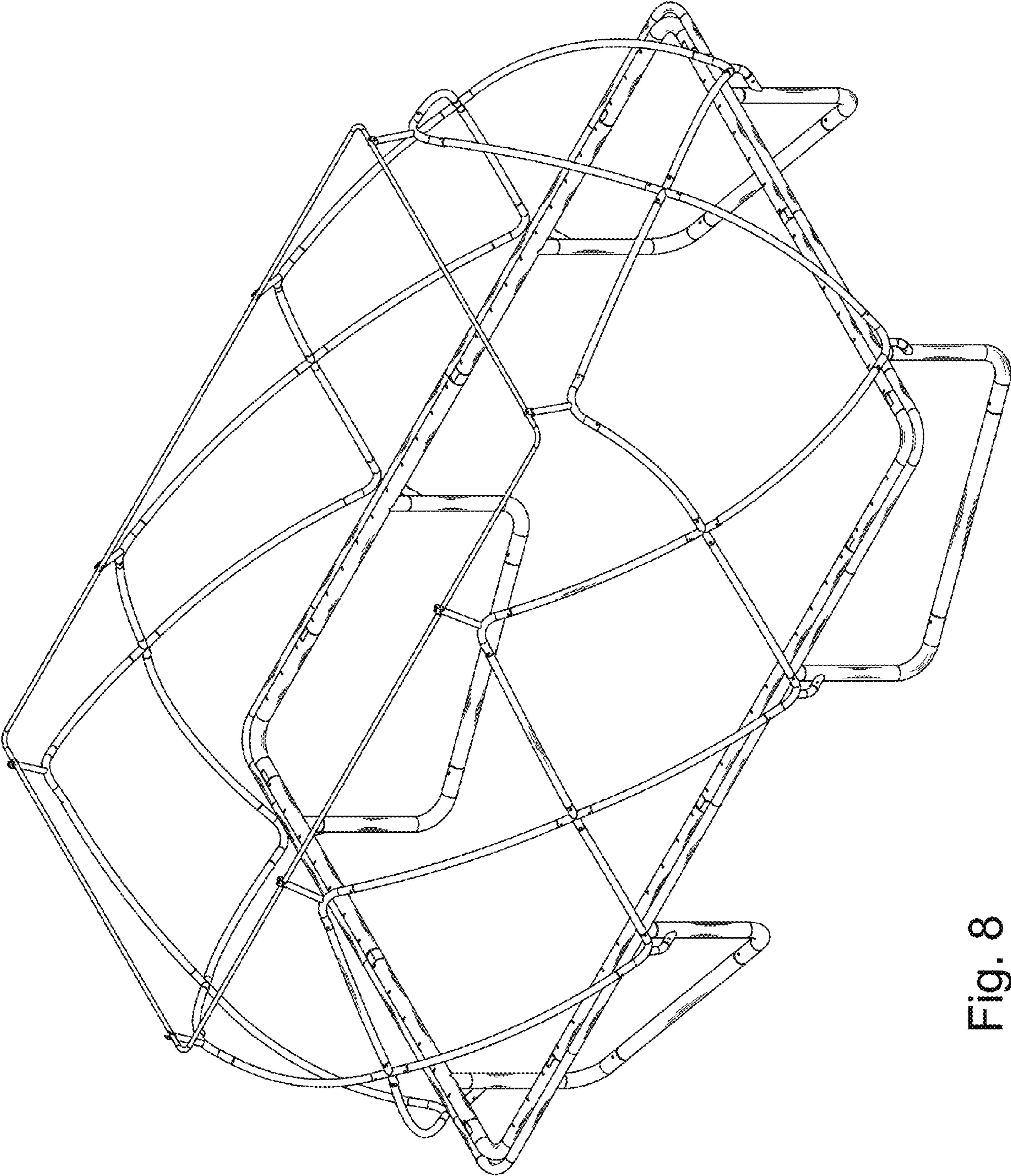

Fig. 8