



US00D917616S

(12) **United States Design Patent**  
**Thiele**

(10) **Patent No.:** **US D917,616 S**  
(45) **Date of Patent:** **\*\* Apr. 27, 2021**

(54) **BURLAP LETTER BOARD**

(71) Applicant: **Main Event USA LLC**, Nashville, TN (US)

(72) Inventor: **Mayne Thiele**, Nashville, TN (US)

(73) Assignee: **MAIN EVENT USA LLC**, Nashville, TN (US)

(\*\*) Term: **15 Years**

(21) Appl. No.: **29/716,888**

(22) Filed: **Dec. 12, 2019**

(51) **LOC (13) Cl.** ..... **19-06**

(52) **U.S. Cl.**  
USPC ..... **D19/113**

(58) **Field of Classification Search**  
USPC ..... D19/88, 113, 114; D6/300–314;  
D7/698; D20/21, 40, 42, 43

(Continued)

(56) **References Cited**

**U.S. PATENT DOCUMENTS**

177,589 A 5/1876 Thomas  
503,373 A \* 8/1893 Heinze et al. .... B32B 5/26  
428/76

(Continued)

**OTHER PUBLICATIONS**

10×10 Premium Solid Oak Framed Changeable Letter Board, with Free Canvas Bag, 340 Characters (340 White), by Virginia’s Store, Manufacturer: Hello Crafts, ASIN: B0728BX5HM, online on Amazon.com, Date First Available: May 17, 2017.\*

(Continued)

*Primary Examiner* — Elizabeth A. Albert

(74) *Attorney, Agent, or Firm* — Innovation Capital Law Group, LLP; Vic Lin

(57) **CLAIM**

The ornamental design for a burlap letter board, as shown and described.

**DESCRIPTION**

FIG. 1 is a front view of a first embodiment of a burlap letter board;

FIG. 2 is a rear view of the first embodiment;

FIG. 3 is a left elevation view of the first embodiment;

FIG. 4 is a right elevation view of the first embodiment;

FIG. 5 is a top plan view of the first embodiment;

FIG. 6 is a bottom plan view of the first embodiment;

FIG. 7 is a front perspective view of the first embodiment;

FIG. 8 is a rear perspective view of the first embodiment;

FIG. 9 is a front view of a second embodiment of a burlap letter board;

FIG. 10 is a rear view of the second embodiment;

FIG. 11 is a left elevation view of the second embodiment;

FIG. 12 is a right elevation view of the second embodiment;

FIG. 13 is a top plan view of the second embodiment;

FIG. 14 is a bottom plan view of the second embodiment;

FIG. 15 is a front perspective view of the second embodiment;

FIG. 16 is a rear perspective view of the second embodiment;

FIG. 17 is a front view of a third embodiment of a burlap letter board;

FIG. 18 is a rear view of the third embodiment;

FIG. 19 is a left elevation view of the third embodiment;

FIG. 20 is a right elevation view of the third embodiment;

FIG. 21 is a top plan view of the third embodiment;

FIG. 22 is a bottom plan view of the third embodiment;

FIG. 23 is a front perspective view of the third embodiment;

FIG. 24 is a rear perspective view of the third embodiment; and,

FIG. 25 is a detail view of the areas identified in FIGS. 7, 15 and 23.

The broken lines in the FIGURES show portions of the burlap letter board which form no part of the claimed design. The letter board is shown with symbolic breaks in its length and width indicated with dash-dot-dash lines. The appear-

(Continued)

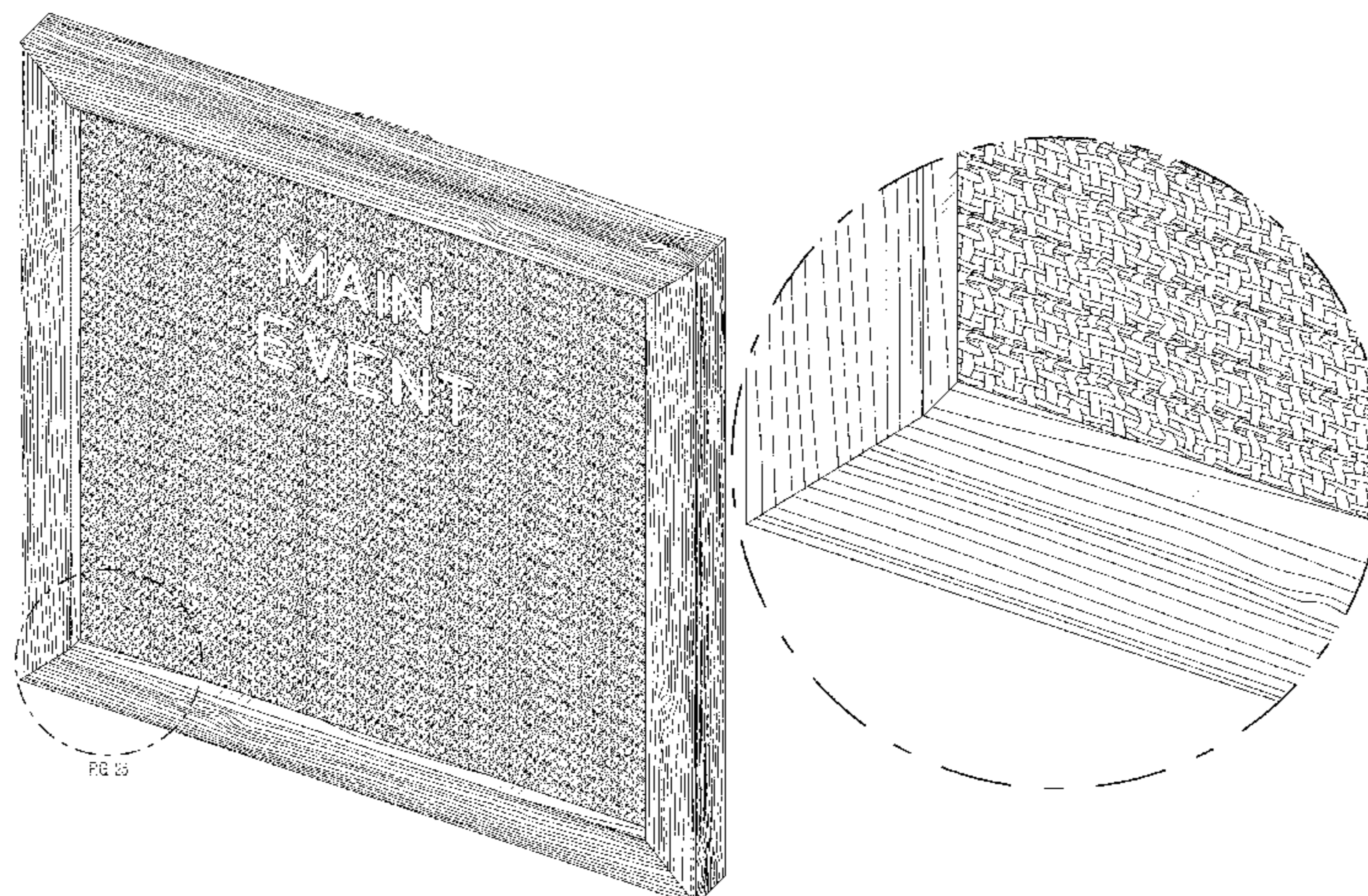

ance of any portion of the article between the break lines forms no part of the claimed design.

**1 Claim, 19 Drawing Sheets**

(58) **Field of Classification Search**

CPC ..... A47G 1/065; A47G 1/0616; B43L 1/00; B43L 1/002; B43L 1/008; B43L 1/04; B43L 1/08; B43L 1/10; B43L 5/00; B44D 3/18; B44D 3/185; G09F 15/00; G09F 15/0056; G09F 15/0068

See application file for complete search history.

(56) **References Cited**

U.S. PATENT DOCUMENTS

1,132,097	A	3/1915	Karpen	
1,190,069	A	7/1916	Abernethy	
1,209,986	A *	12/1916	Mason	B44D 3/18 442/10
1,246,095	A	11/1917	Herrmann	
1,334,879	A *	3/1920	Zinser	B44D 3/18 428/170
1,358,534	A	11/1920	Finch	
1,432,519	A	10/1922	Atwater	
1,616,445	A *	2/1927	Francis	B44D 3/18 245/10
D91,287	S *	1/1934	Weiler et al.	D19/114
2,104,366	A *	1/1938	Gossett	G09F 15/0006 40/611.03
2,110,155	A *	3/1938	Ibendorff	B43L 5/00 434/425
2,682,125	A	6/1954	Coffield	
2,697,293	A	12/1954	Greenhut	
2,777,232	A *	1/1957	Kulicke	A47G 1/0611 40/780
2,791,051	A	5/1957	Scheyer	
2,911,747	A *	11/1959	Sundt	B44D 3/18 428/90
3,337,978	A	8/1967	Weeks	
D213,882	S *	4/1969	Sonnenblick	D6/300
3,665,627	A	5/1972	Maccluney	
4,063,378	A	12/1977	Burke	
D247,598	S	3/1978	Kearney	
4,157,624	A *	6/1979	Sobel	A47G 1/162 40/759
D255,856	S *	7/1980	Higson	D6/300
4,457,723	A *	7/1984	Tate	B43L 1/008 139/425 R
4,947,565	A	8/1990	Shadwell	

5,253,439	A *	10/1993	Shanok	G09F 1/12 40/594
5,419,063	A *	5/1995	Lane	A45C 11/16 206/6.1
D390,010	S *	2/1998	Fry	D6/302
5,781,980	A *	7/1998	Golston	G09F 3/20 29/450
D398,066	S *	9/1998	Noel	D26/56
D483,747	S	12/2003	Berube	
6,962,016	B1	11/2005	Meyer	
7,117,998	B2	10/2006	Krapf	
D542,543	S	5/2007	Bruce	
D682,560	S *	5/2013	Gschwandegger	D6/300
9,174,483	B2 *	11/2015	Ridless	B44F 11/02
D782,211	S *	3/2017	Randhawa	D6/300
9,857,657	B2 *	1/2018	Ash	G02F 1/13318
D811,752	S	3/2018	Ross, III et al.	
D825,659	S *	8/2018	He	D19/113
10,092,118	B2 *	10/2018	Ridless	A47G 1/141
10,149,557	B2	12/2018	Vestergaard	
D851,172	S	6/2019	Vaiden	
2003/0046849	A1	3/2003	Lin	
2005/0268510	A1	12/2005	Humphrey	
2007/0163159	A1	7/2007	Fernandez Conesa	

OTHER PUBLICATIONS

Felt Letter Board 10×10 (Black) +685 Pre-Cut Letters +Stand +Upgraded Wooden Sorting Tray!, by Little Hippo, ASIN: B075JG2MVQ, online on Amazon.com, Date First Available: Sep. 11, 2017.\*

Felt Letter Board Message Sign—Cursive Word Pack, 640 Black & White Characters, by Henro, Manufacturer Part No. H7001, ASIN: B07BS8M57S, online on Amazon.com, Date First Available: Mar. 28, 2018.\*

Burlap Letter Board—The New Felt Letter Board—10×10 INch, Rustic Shabby Chic Wood Frame, 374 Precut White Letters, by Mainevent, Manufact. Part No. 692769229251, ASIN: B0851JM1CN, online Amazon.com, Date First Available: Apr. 20, 2020.\*

10×10 Premium Solid Oak Framed Changeable Letter Board, with Free Canvas Bag, 340 Characters (340 White) by Virginia’s Store, 158 ratings, Manufacturer: Hello Crafts, ASIN: B0728BX5HM, on Amazon.com, Date First Available May 17, 2017.

Felt Letter Board 10×10 (Black) I +685 Pre-Cut Letters +Stand +Upgraded Wooden Sorting Tray! Letters Board, Letter Boards, letterboard, Word Board, Message Board, Letter Sign, Changeable, by Little Hippo, ASIN: B075JG2MVQ, on Amazon.com, Date First available Sep. 11, 2017.

Felt Letter Board Message Sign—Cursive Word Pack, 640 Black & White Characters, 10×10 Gray Changeable Letterboard, Wall & Tabletop Display, 2 Storage Pouches & Gift Box, by Henro, 847 ratings, ASIN: B07BS8M57S, on Amazon.com, Date First Available Mar. 28, 2018.

\* cited by examiner

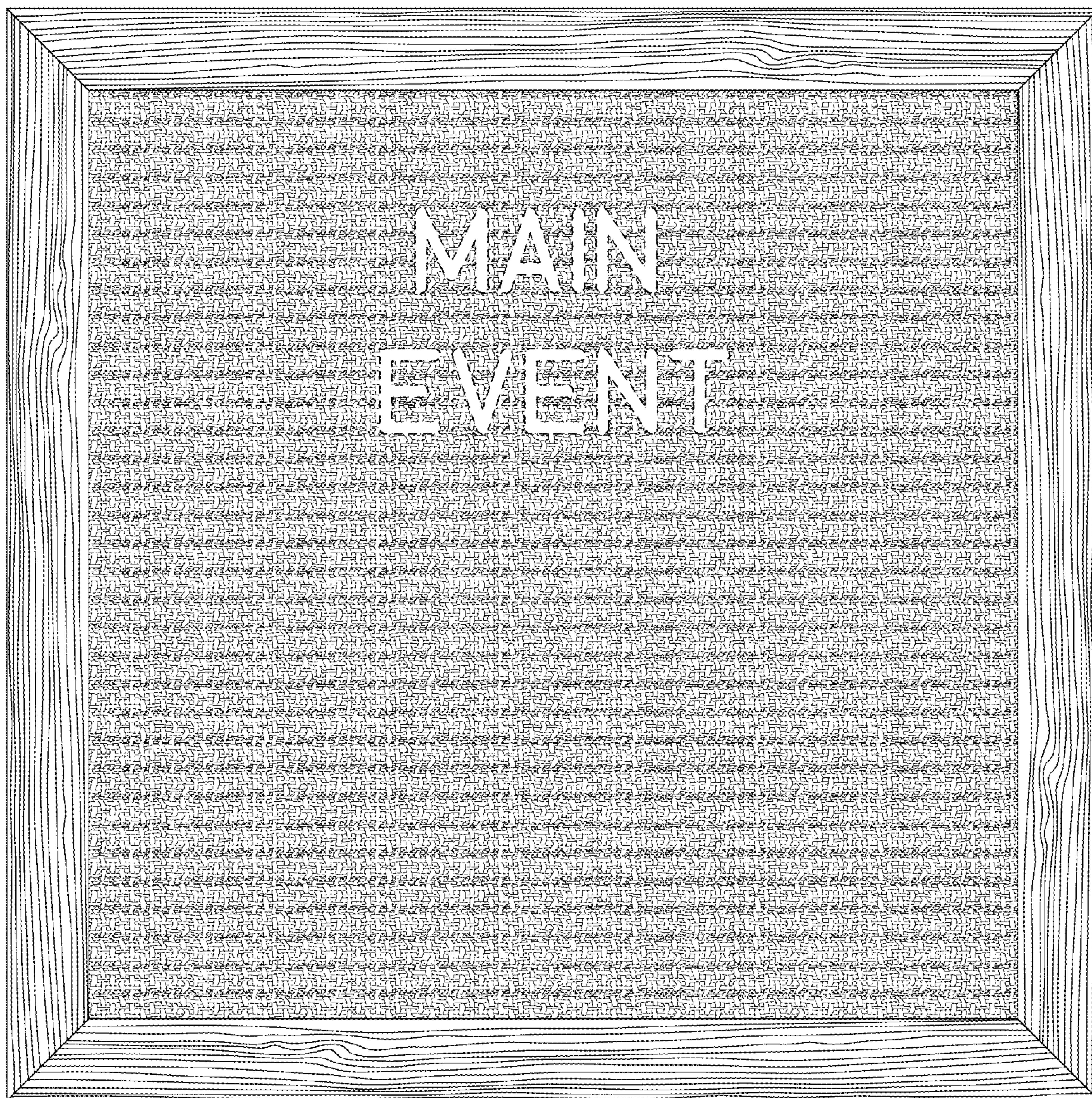

FIG. 1

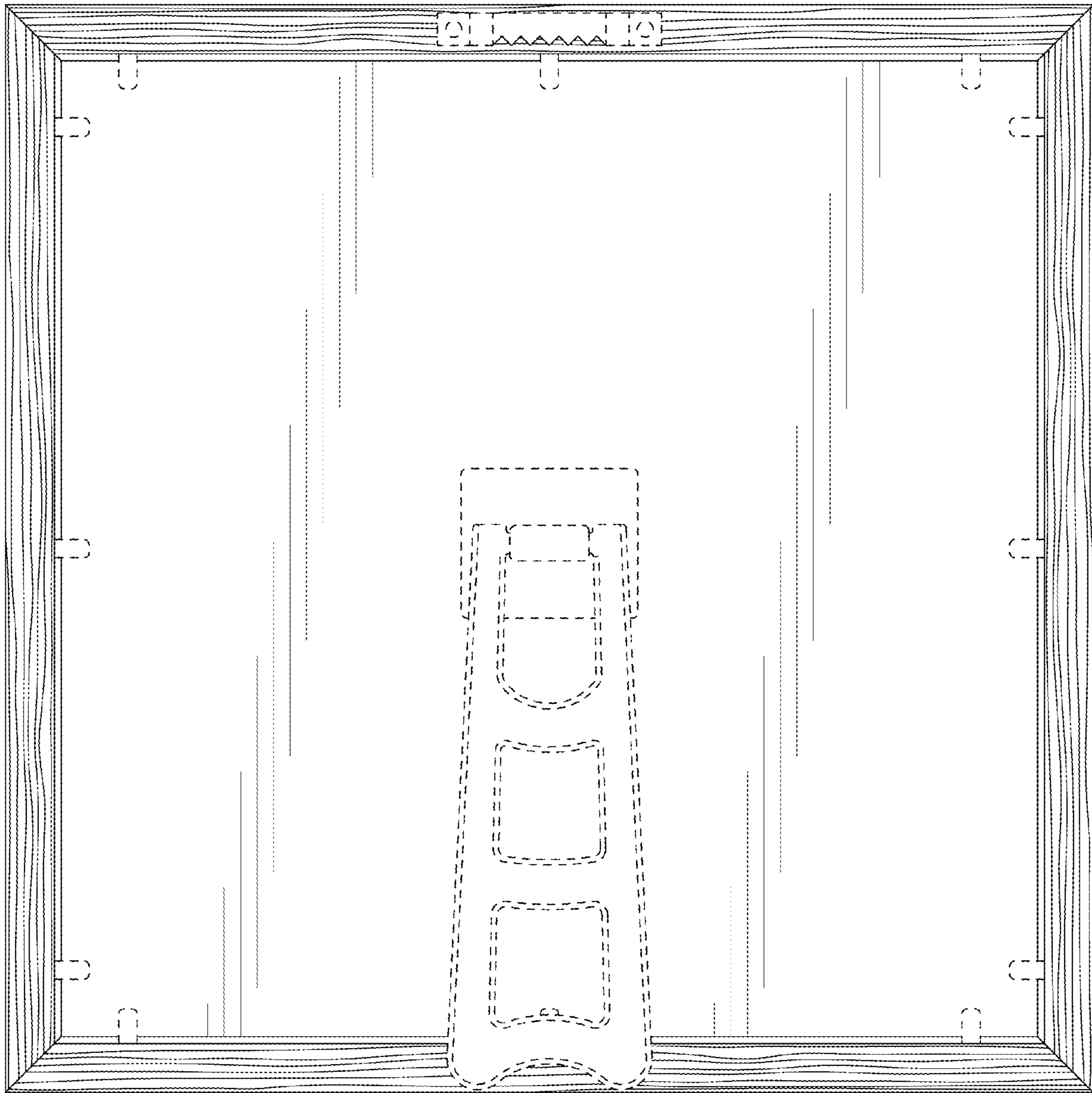

FIG. 2

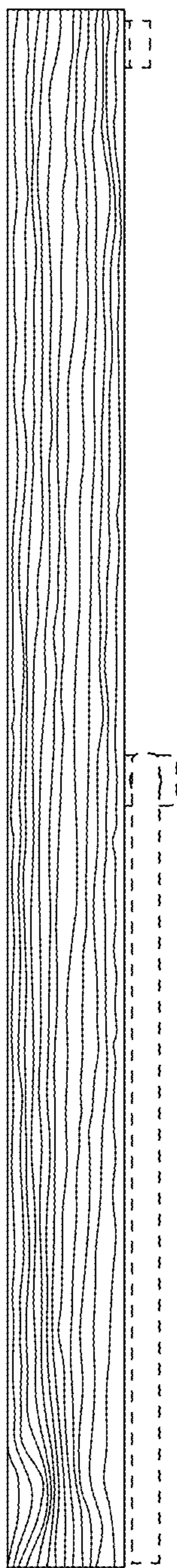

FIG. 3

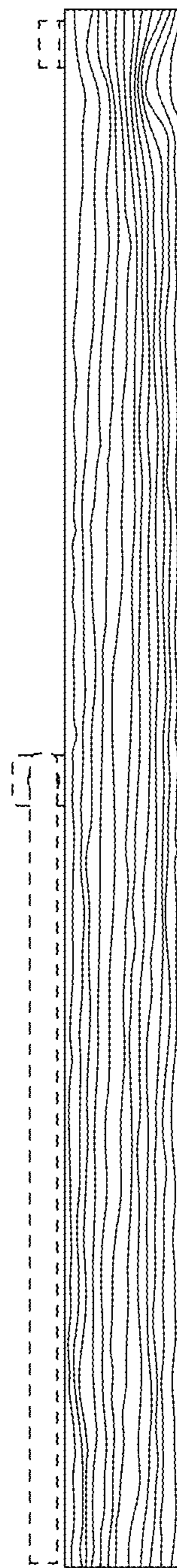

FIG. 4

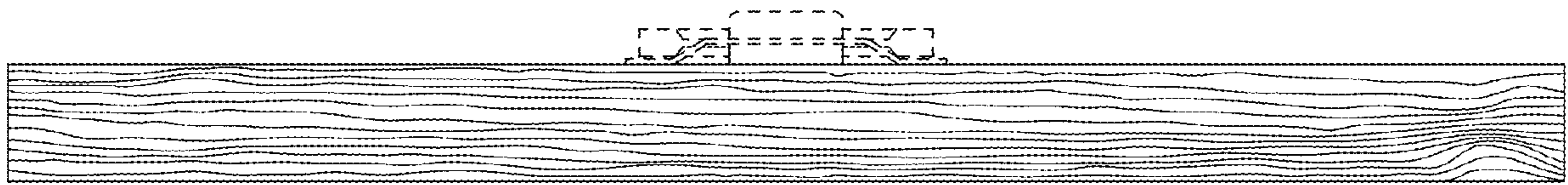

FIG. 5

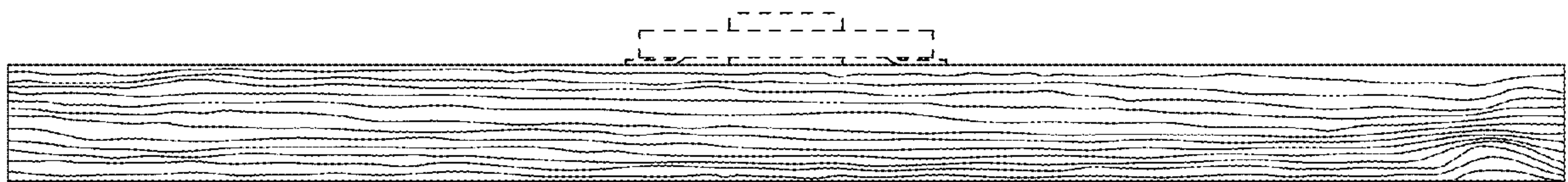

FIG. 6

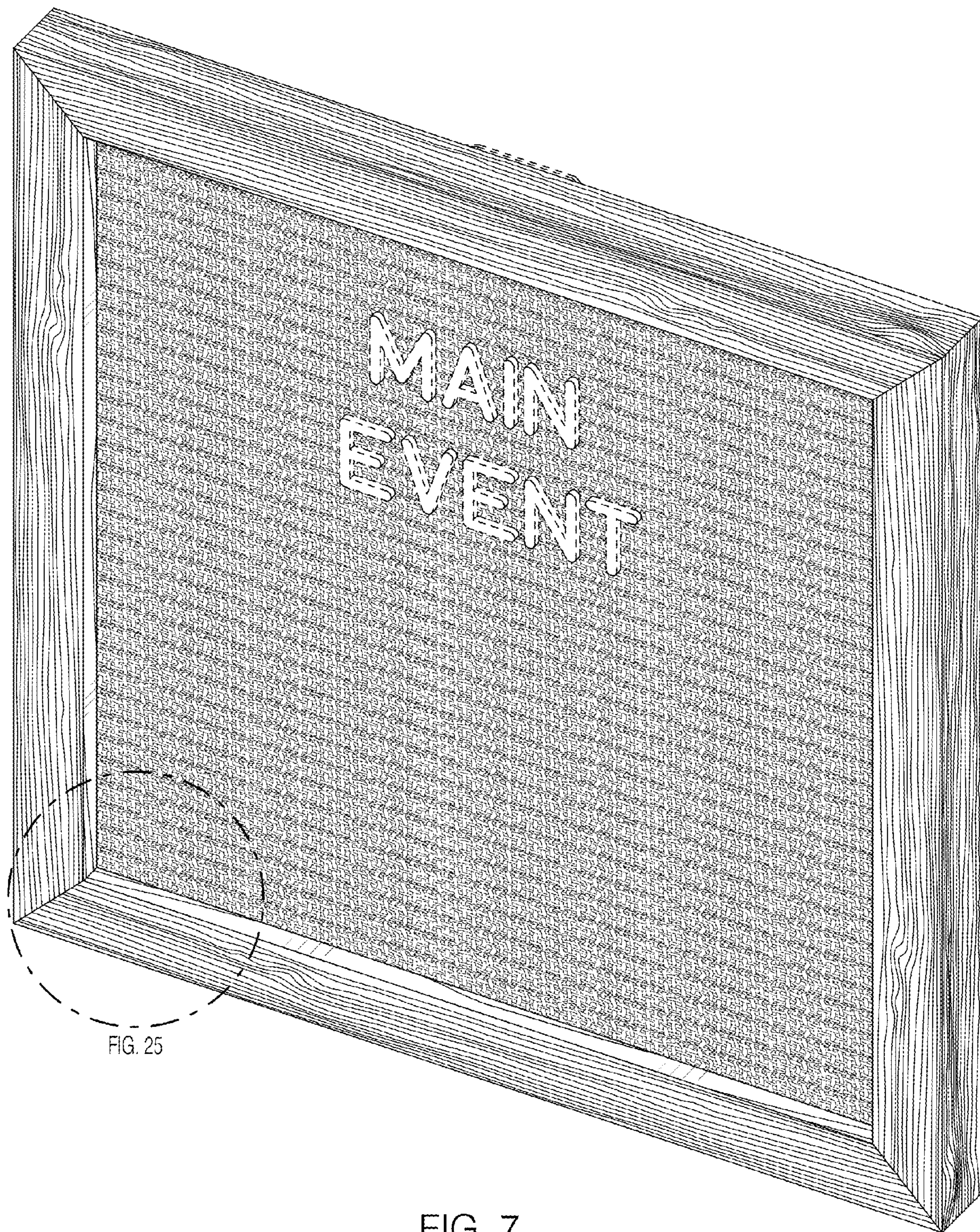

FIG. 7

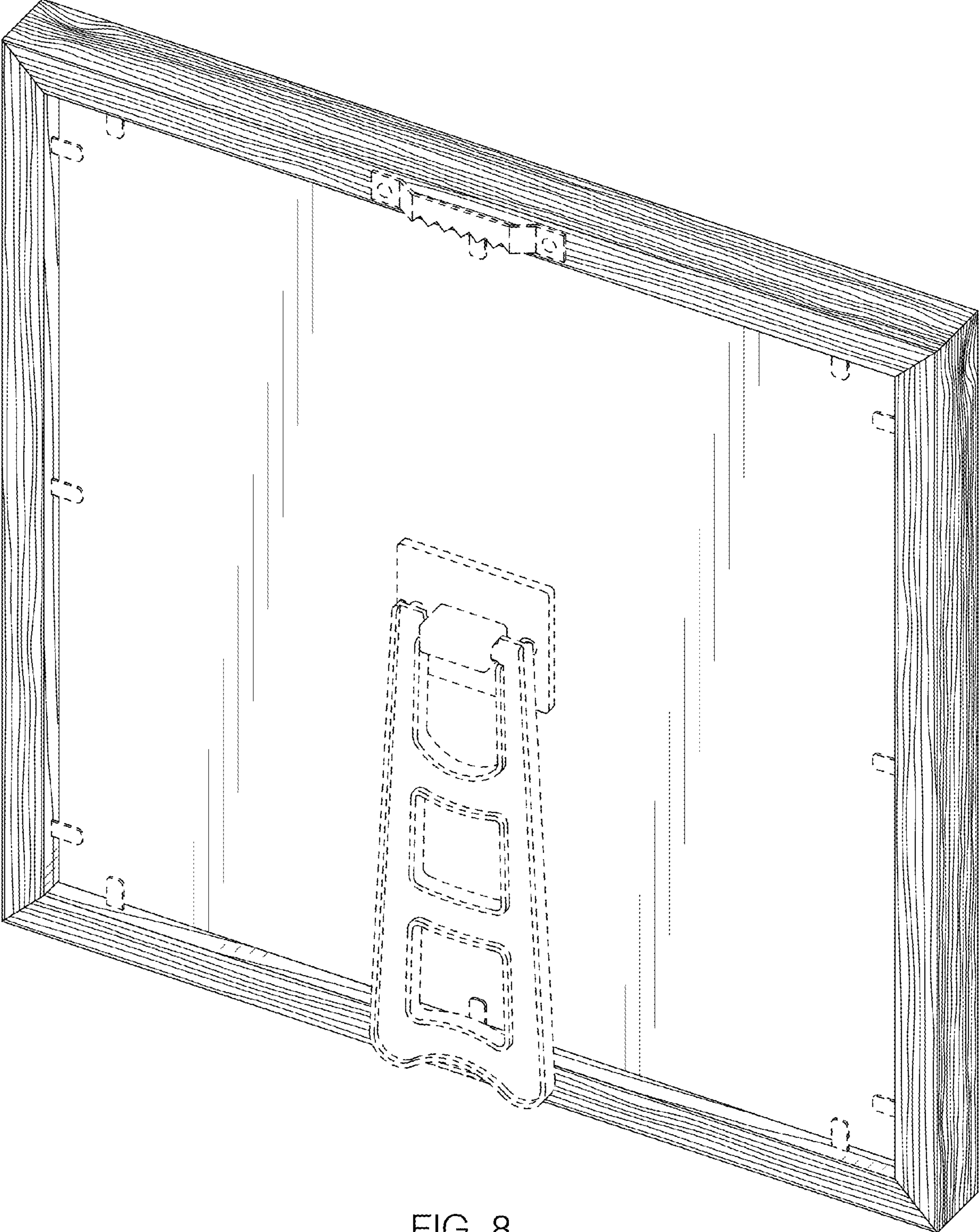

FIG. 8



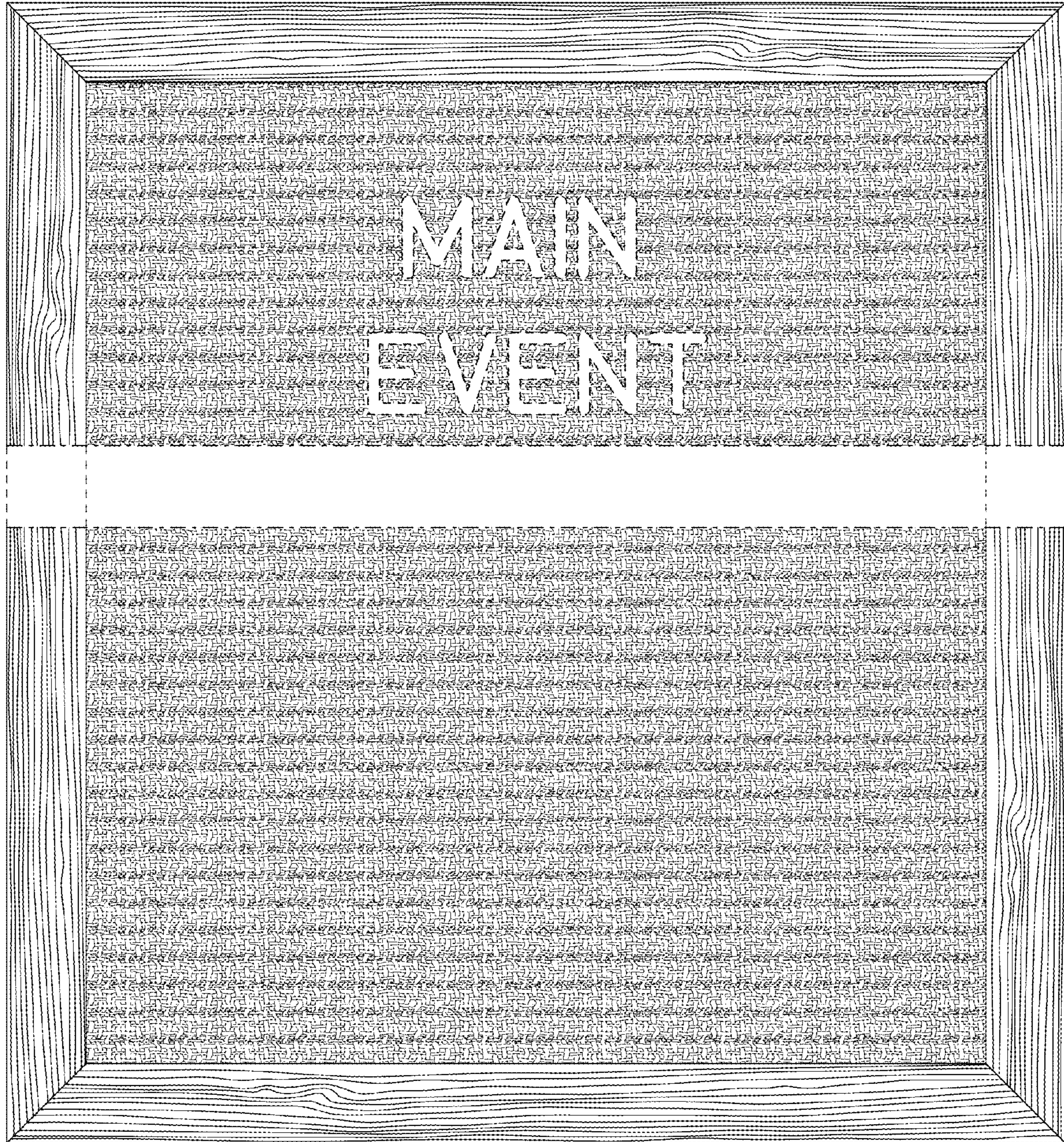

FIG. 9

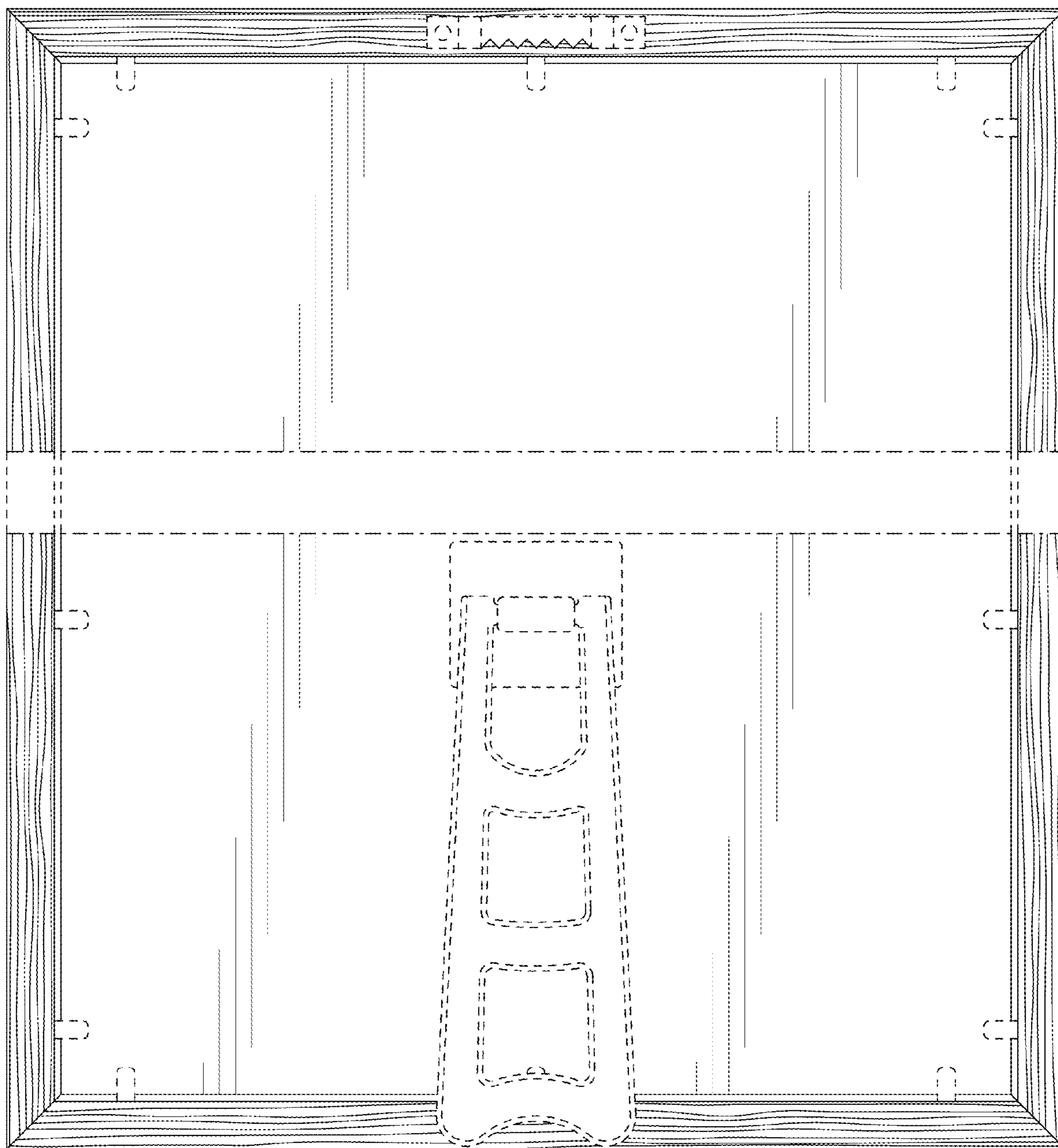

FIG. 10

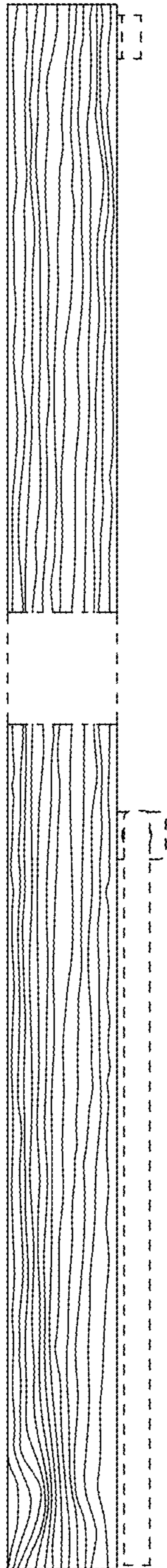

FIG. 11

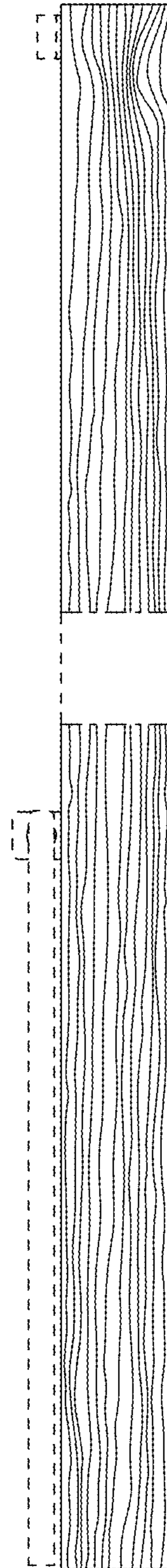

FIG. 12

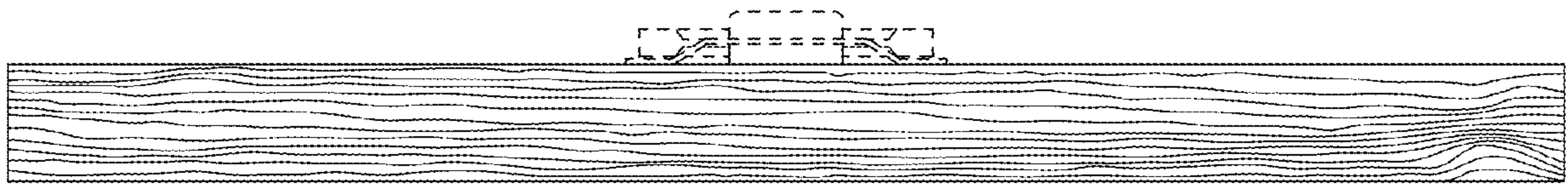

FIG. 13

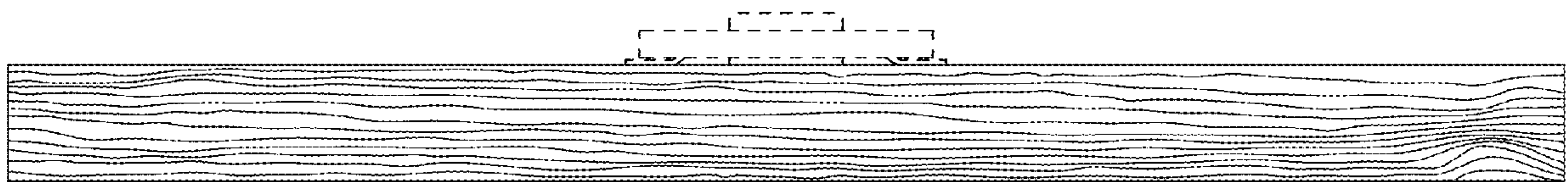

FIG. 14

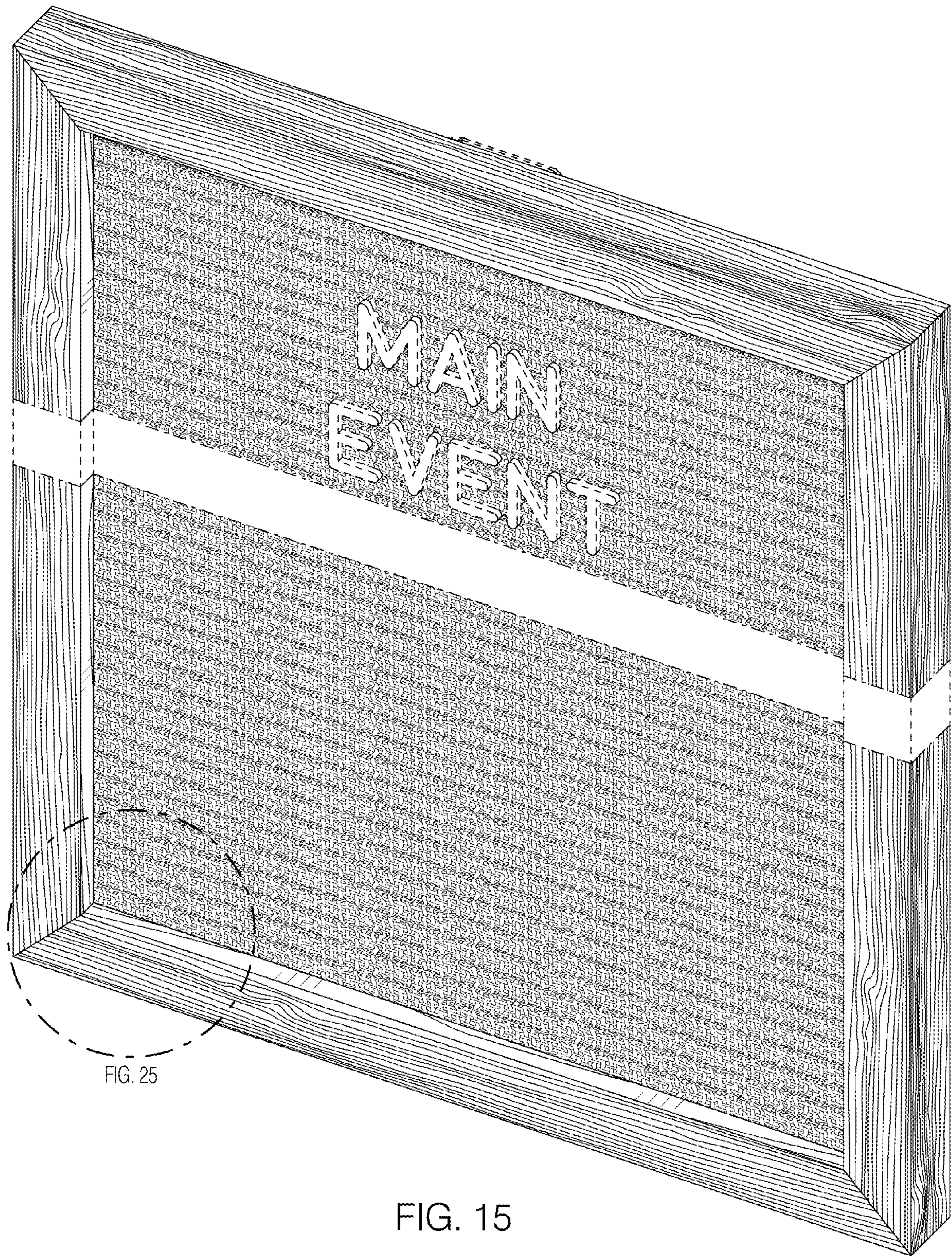

FIG. 25

FIG. 15

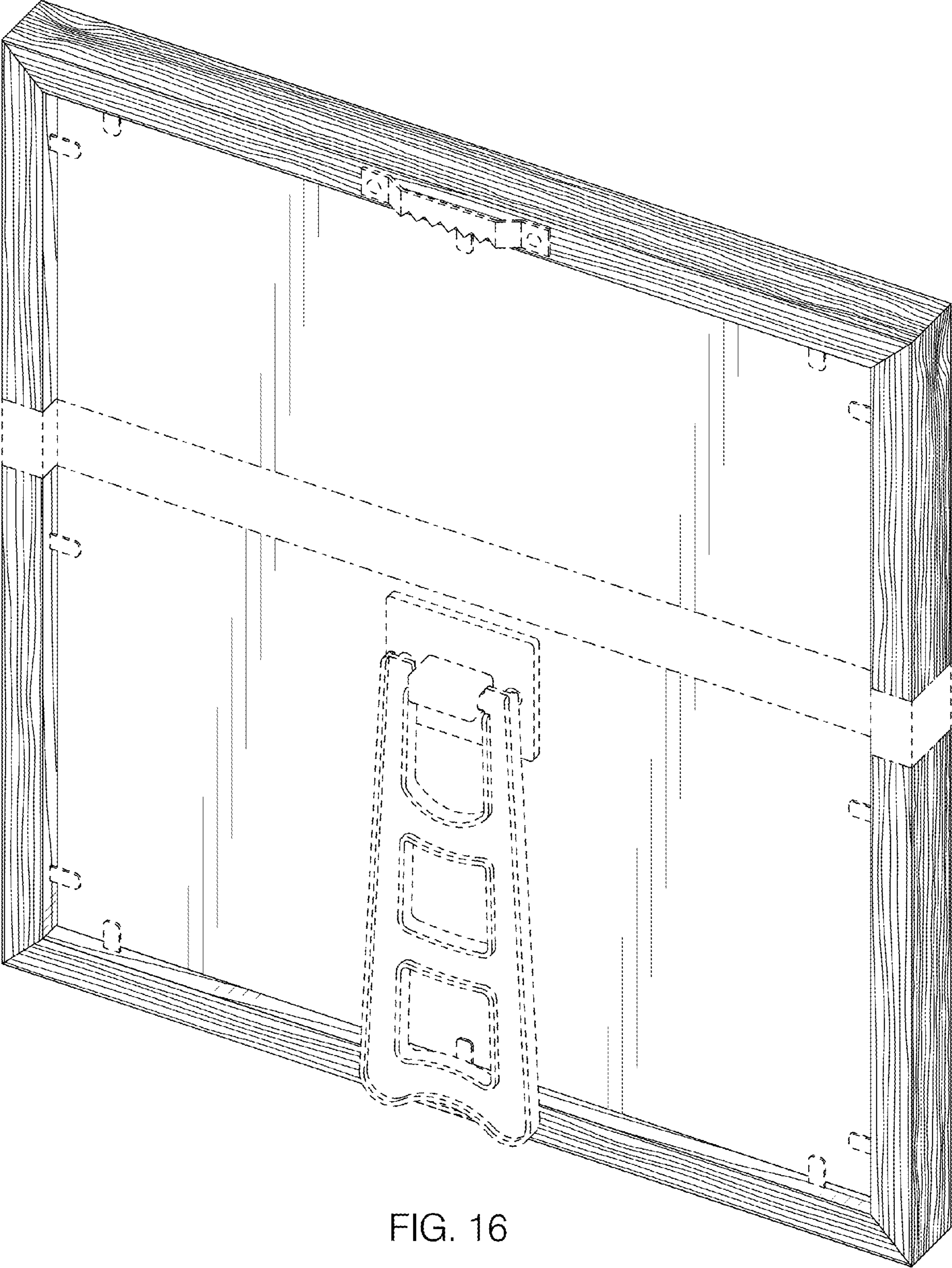

FIG. 16

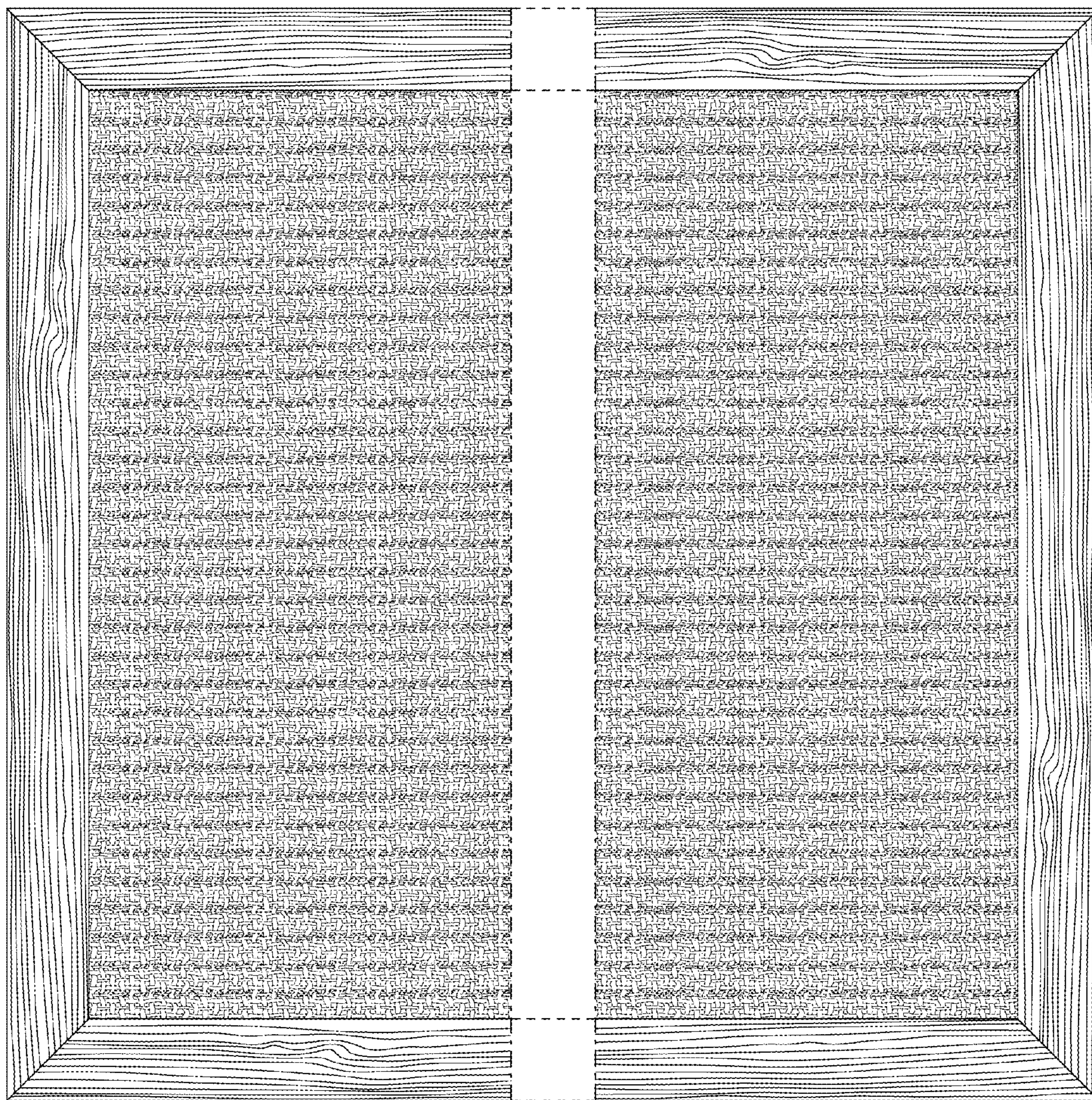

FIG. 17

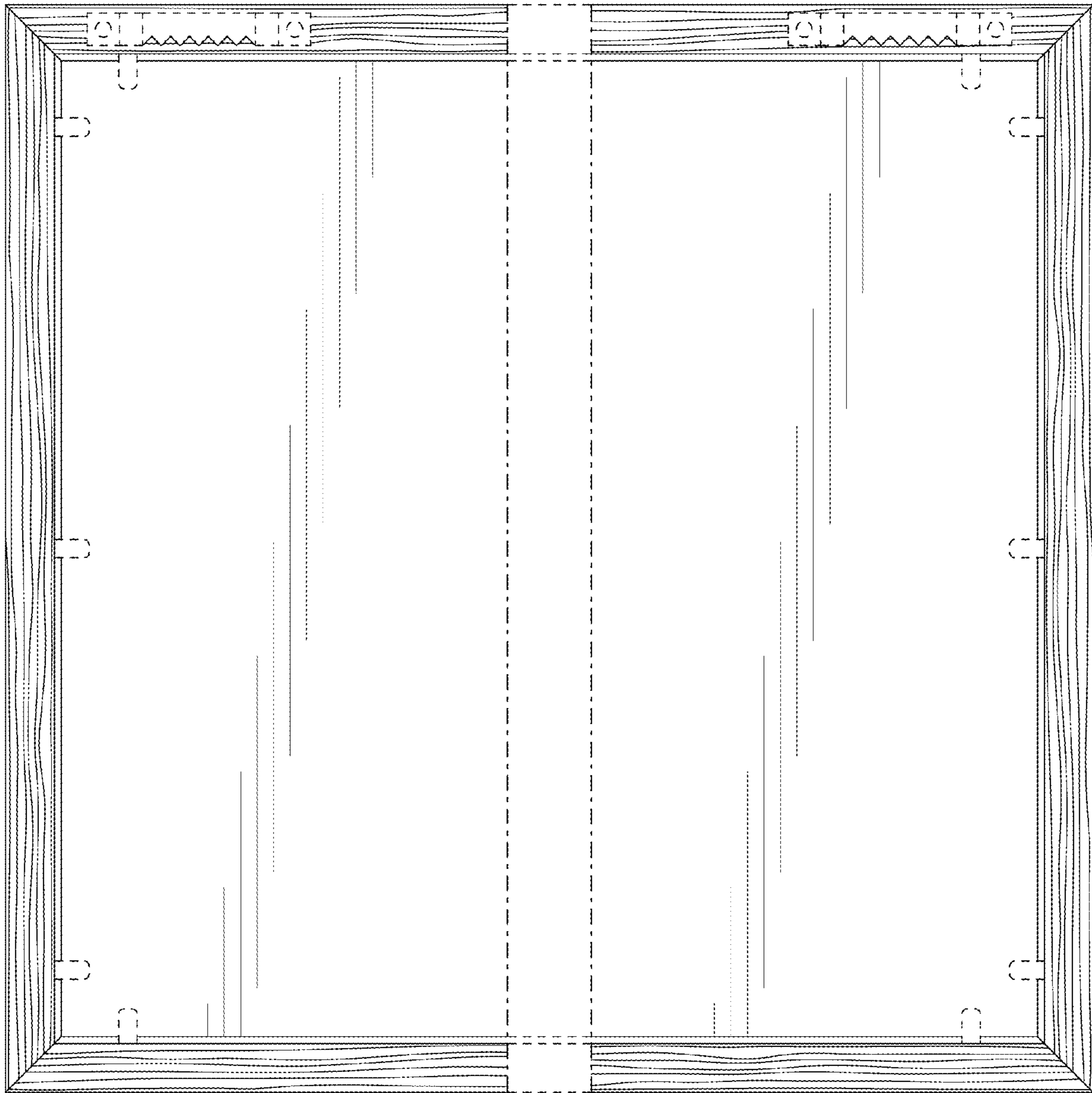

FIG. 18



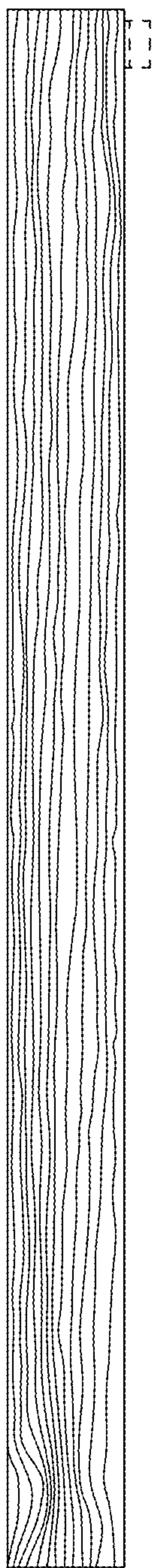

FIG. 19

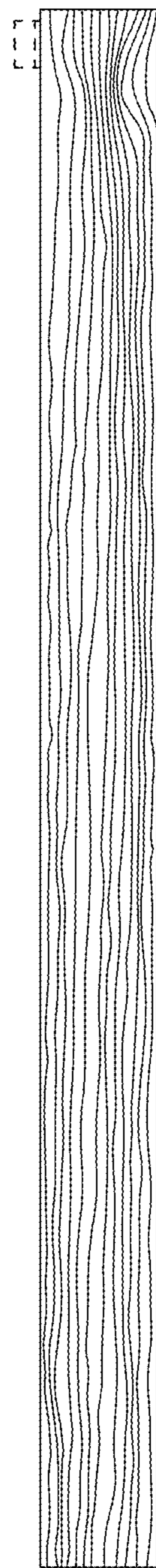

FIG. 20

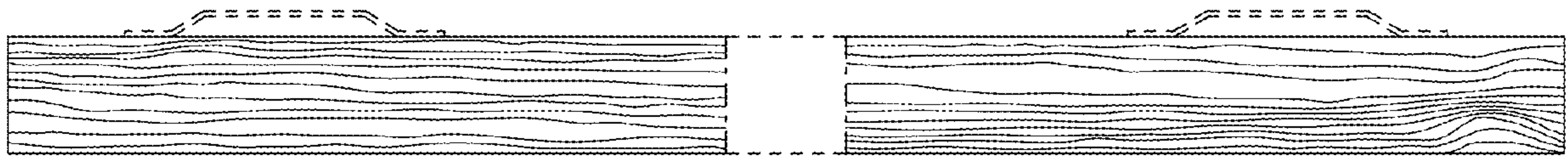

FIG. 21

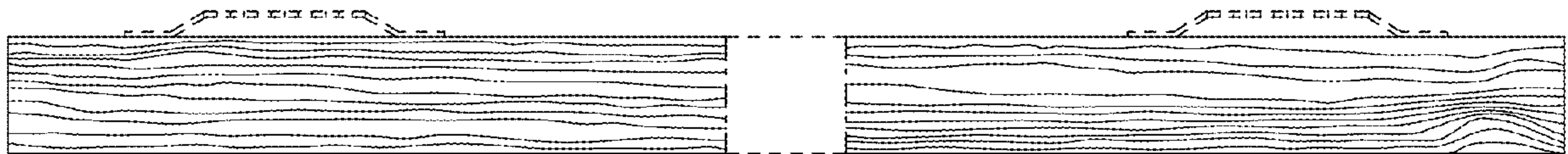
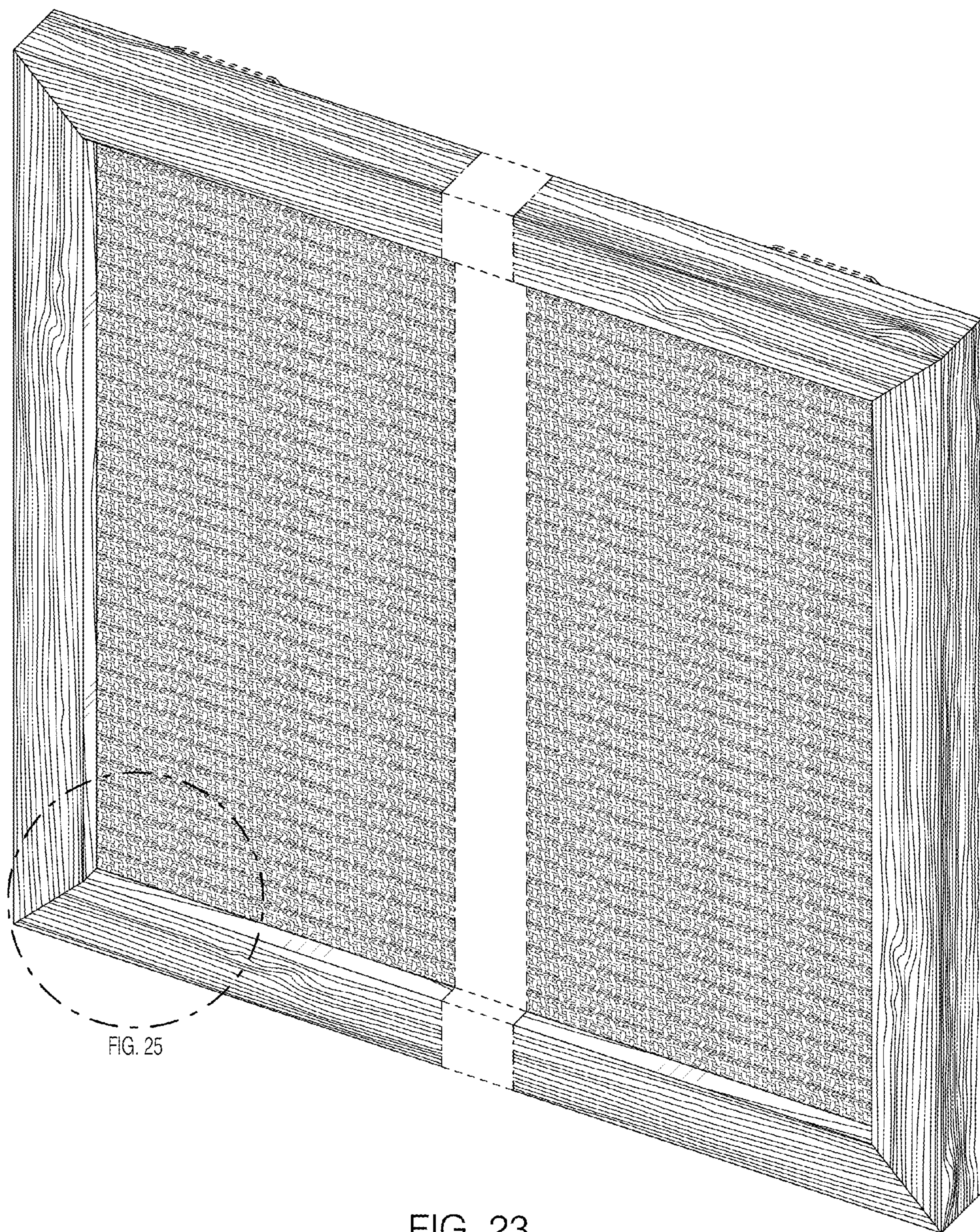

FIG. 22



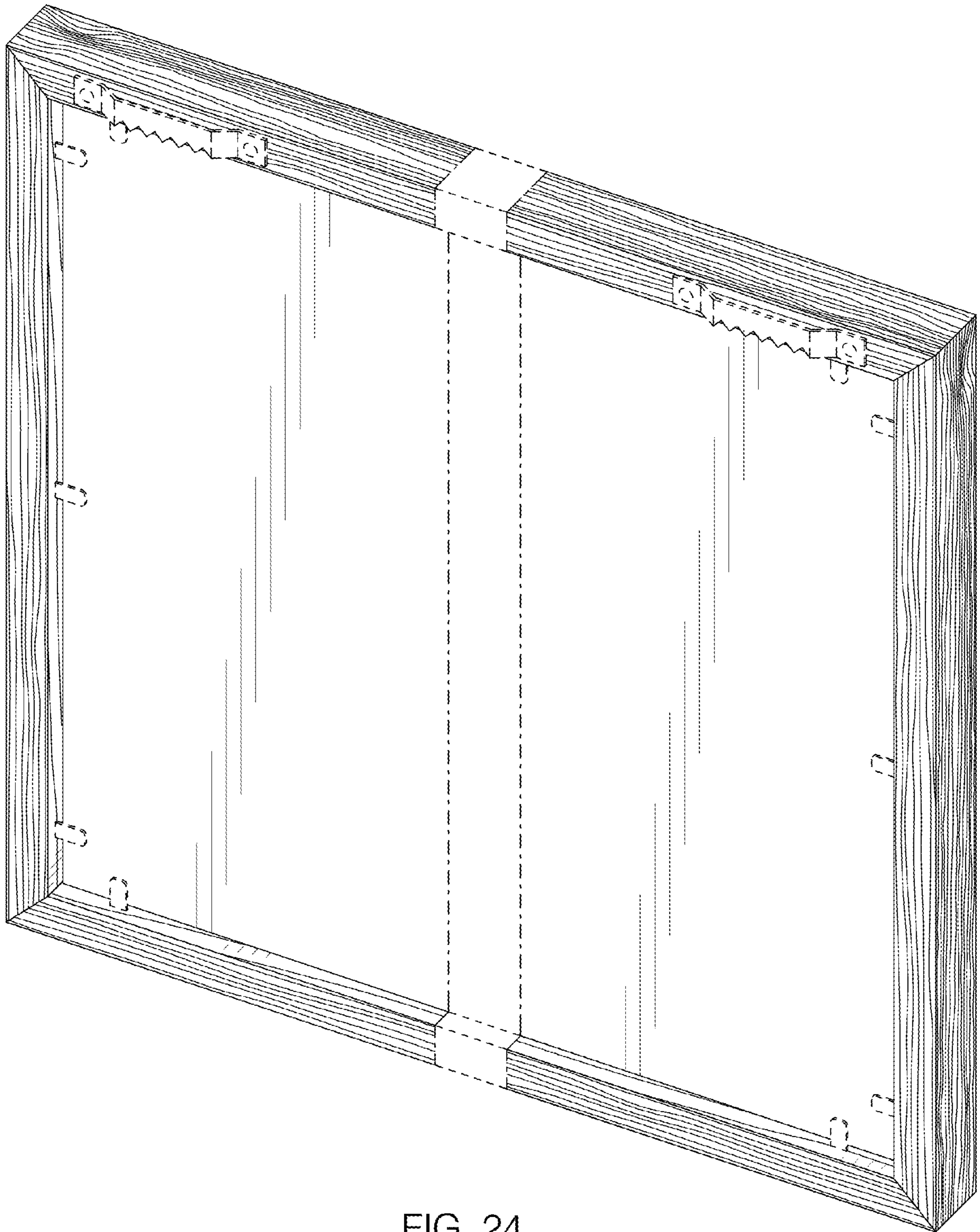

FIG. 24

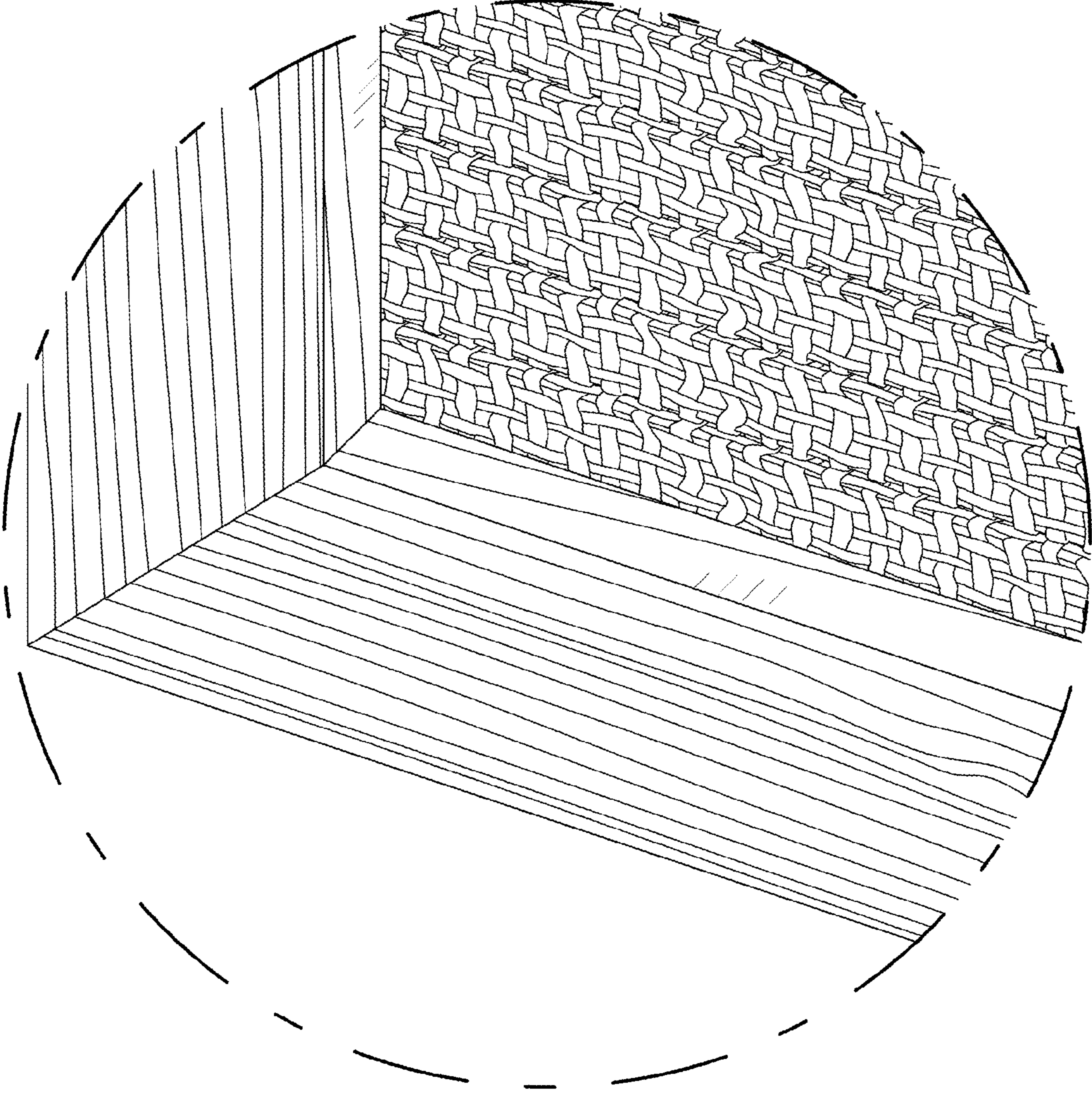

FIG. 25