



US00D917582S

(12) **United States Design Patent**
Jones et al.

(10) **Patent No.:** **US D917,582 S**
(45) **Date of Patent:** **** Apr. 27, 2021**

- (54) **ROLLER VALVE ROD GUIDE**
- (71) Applicant: **Premium Tools LLC**, Houston, TX (US)
- (72) Inventors: **Roy Jones**, Houston, TX (US); **Zach Driver**, Houston, TX (US)
- (73) Assignee: **PREMIUM TOOLS LLC**, Houston, TX (US)
- (**) Term: **15 Years**
- (21) Appl. No.: **29/678,096**
- (22) Filed: **Jan. 25, 2019**
- (51) **LOC (13) Cl.** **15-04**
- (52) **U.S. Cl.**
USPC **D15/21; D15/138**
- (58) **Field of Classification Search**
USPC D15/5, 138, 21; 137/14; 417/552;
166/229, 296, 319, 99, 298, 301;
294/86.12, 86.22, 86.27, 86.34
CPC E21B 33/12; E21B 33/13; E21B 33/14;
E21B 33/126; E21B 33/134; E21B 34/00;
E21B 34/063; E21B 34/06; E21B 34/14;
E21B 33/129; E21B 23/02; E21B 31/20;
E21B 31/18; F04B 47/12
See application file for complete search history.

- 2,371,385 A * 3/1945 Eckel E21B 43/082
166/63
- 2,617,486 A * 11/1952 Davis E21B 27/00
166/99
- 2,947,362 A * 8/1960 Smith E21B 31/03
294/86.34
- 2,965,177 A * 12/1960 Bus, Sr. E21B 31/00
294/86.34

(Continued)

FOREIGN PATENT DOCUMENTS

CN 305627149 * 2/2020

OTHER PUBLICATIONS

Stinger Valve, first available date Jun. 17, 2019 [Online], [Site Visited Apr. 22, 2020] Available From Internet, URL: <<https://www.drillingtools.com/stinger>> (Year: 2019).*

(Continued)

Primary Examiner — Sheryl Lane
Assistant Examiner — Mark T. Philipps
(74) *Attorney, Agent, or Firm* — D’Ambrosio & Menon, PLLC; Usha Menon

(57) **CLAIM**

The ornamental design for a roller valve rod guide, as shown and described.

DESCRIPTION

FIG. 1 is a top view of our new design for a roller valve rod guide;
FIG. 2 is a bottom view thereof;
FIG. 3 is a right view thereof;
FIG. 4 is a front view thereof;
FIG. 5 is a sectional view thereof taken along the line 5-5 in FIG. 4;
FIG. 6 is a perspective view thereof;
FIG. 7 is a back view thereof; and,
FIG. 8 is a left view thereof.

1 Claim, 8 Drawing Sheets

(56) **References Cited**

U.S. PATENT DOCUMENTS

- 1,751,998 A * 3/1930 Hinderliter E21B 31/12
294/86.12
- 1,829,760 A * 11/1931 Santiago E21B 31/18
294/86.22
- 1,835,067 A * 12/1931 Lidderdale E21B 31/18
294/106
- 1,995,572 A * 3/1935 Lower F01L 3/08
123/188.9
- 2,088,883 A * 8/1937 Tustin E21B 31/125
294/86.27

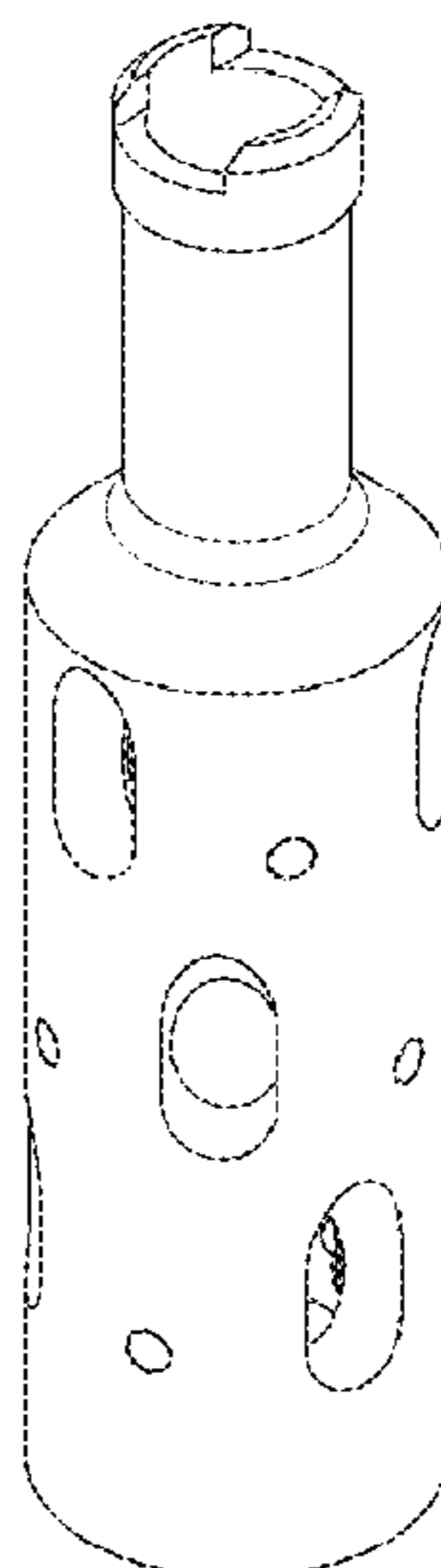

(56)

References Cited

U.S. PATENT DOCUMENTS

2,965,183 A * 12/1960 Bus, Sr. E21B 31/00
294/86.34
3,273,641 A * 9/1966 Bourne E21B 33/134
166/276
3,333,635 A * 8/1967 Crawford E21B 43/082
166/276
3,360,047 A * 12/1967 Burnett E21B 17/04
137/67
3,589,825 A * 6/1971 Wojcik B23G 1/48
408/72 R
5,318,118 A * 6/1994 Duell E21B 33/126
166/202
6,276,394 B1 * 8/2001 Smith F16K 31/5284
137/556
6,746,221 B1 * 6/2004 Havard F04B 47/02
166/369
7,713,035 B2 * 5/2010 Ford F04B 53/20
417/430
D788,197 S * 5/2017 Ford D15/138
10,184,328 B1 * 1/2019 Holleman E21B 43/127

10,309,193 B2 * 6/2019 Gordon E21B 34/063
2009/0266544 A1 * 10/2009 Redlinger E21B 4/02
166/298
2010/0108150 A1 * 5/2010 Ford F04B 47/02
137/14
2012/0118560 A1 * 5/2012 Mikalsen E21B 31/18
166/99
2013/0032348 A1 * 2/2013 Puccio E21B 31/18
166/301
2016/0138368 A1 * 5/2016 Girola E21B 23/02
166/332.8
2018/0245486 A1 * 8/2018 Svensson F01L 3/06
2020/0003021 A1 * 1/2020 Drenth E21B 23/10
2020/0248520 A1 * 8/2020 Johnsen E21B 33/129

OTHER PUBLICATIONS

Products—Locking Mandrels—Western Pressure Controls, Earliest available date Aug. 12, 2020 [Online], [Site visited Aug. 12, 2020] Available From Internet, URL:<<https://westernpressure.com/products/locking-mandrels/>> (Year: 2020).*

* cited by examiner

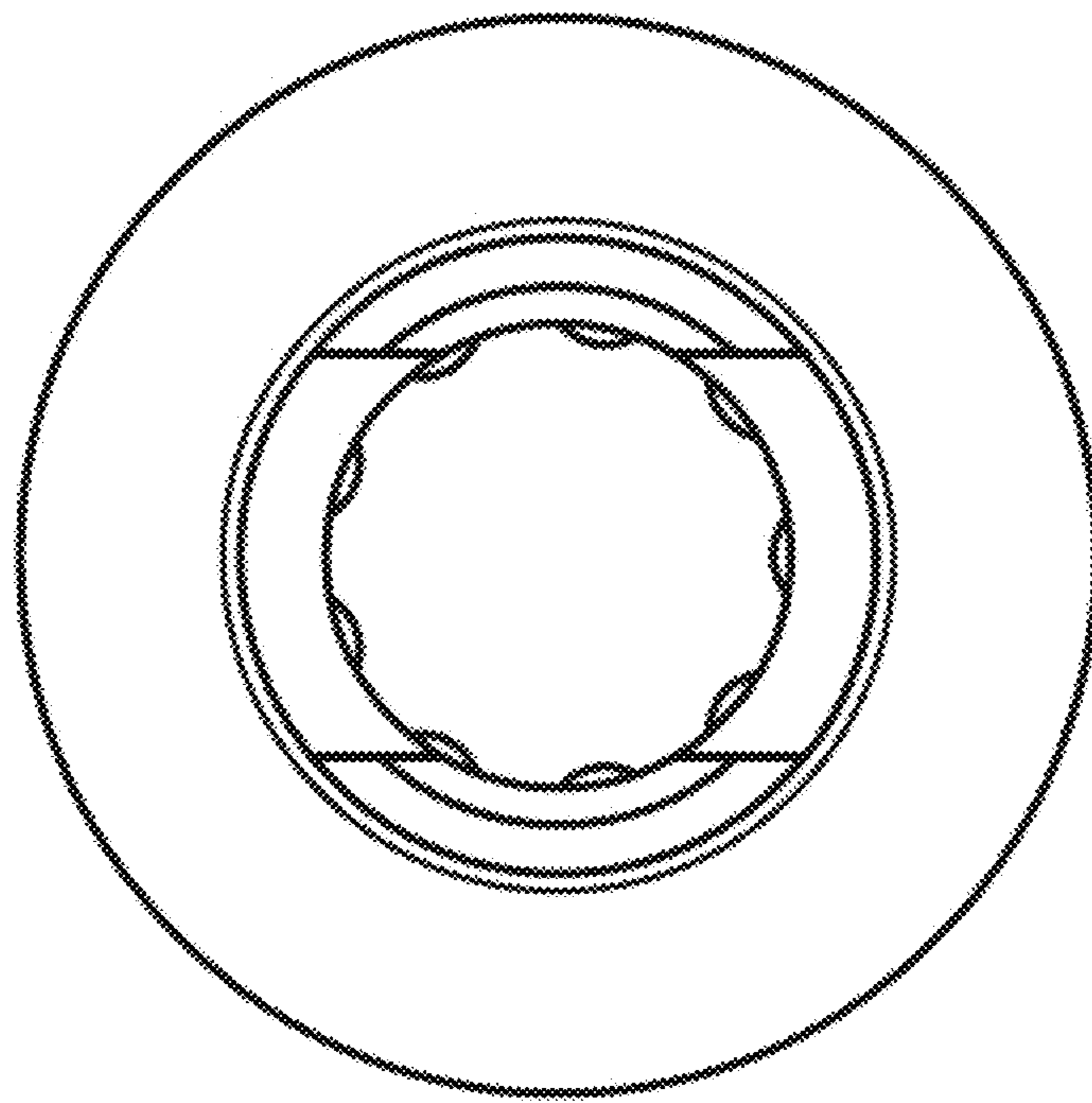

FIG. 1

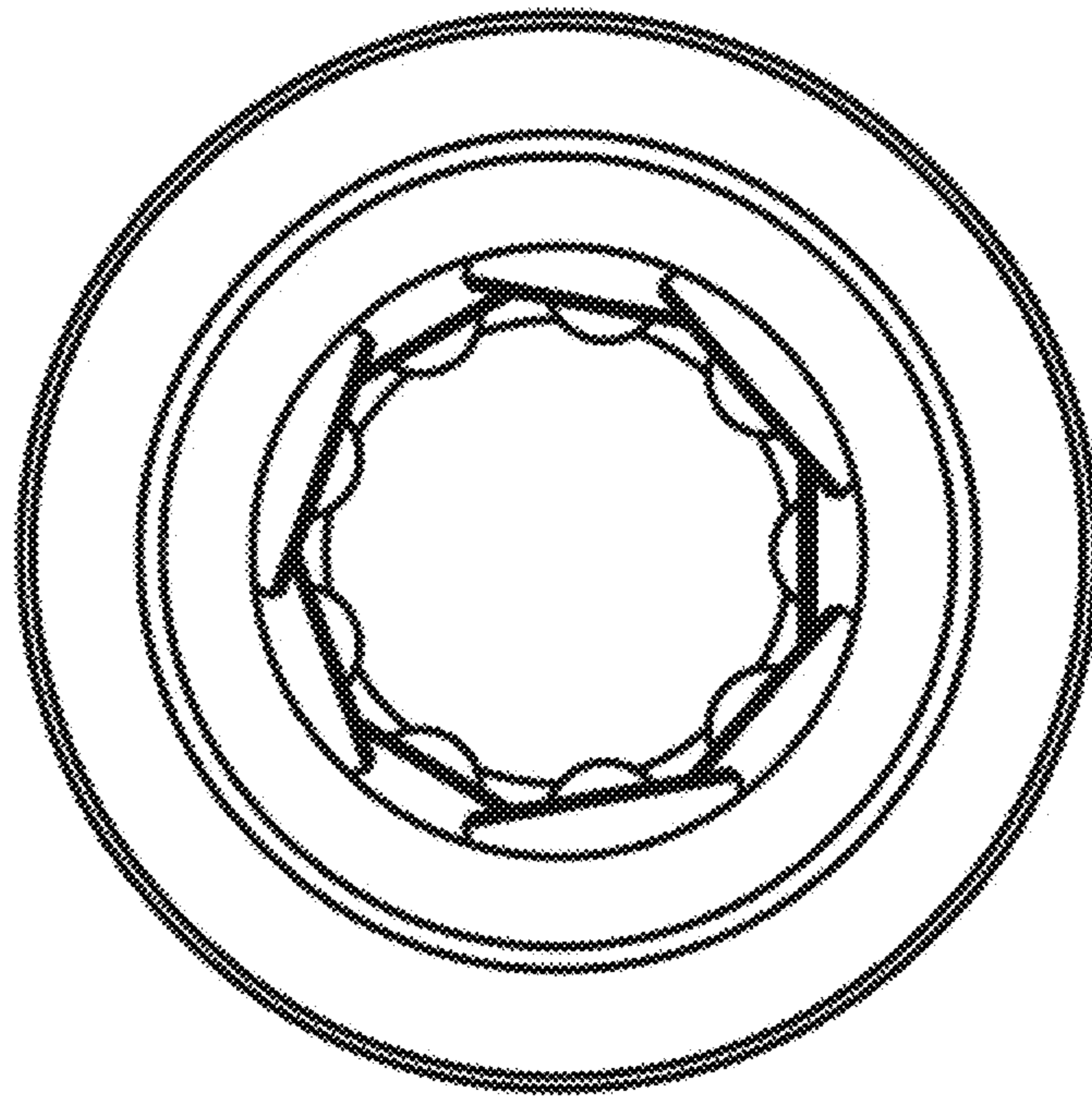

FIG. 2

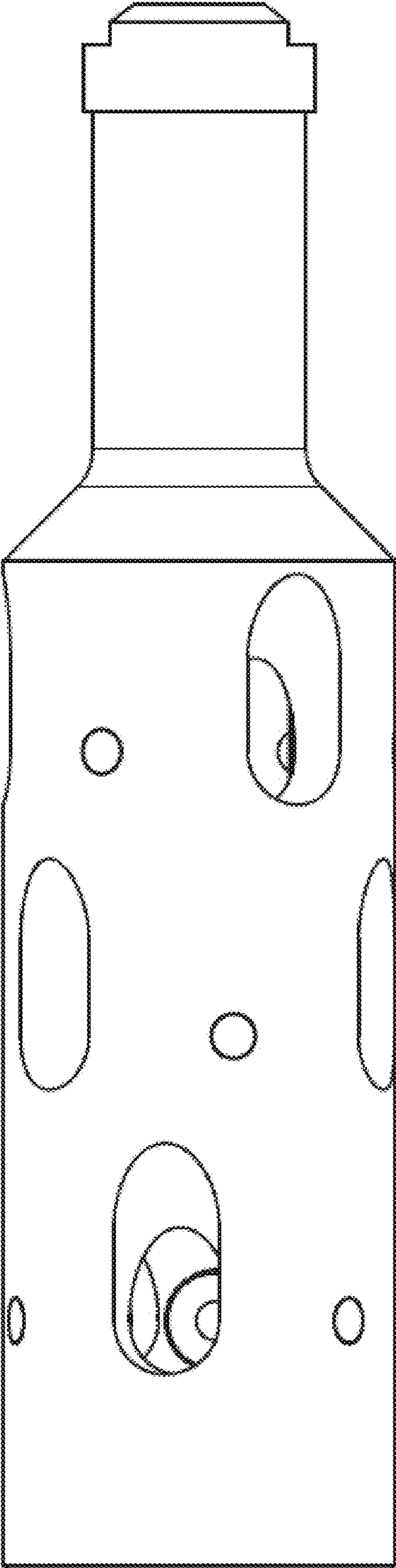

FIG. 3

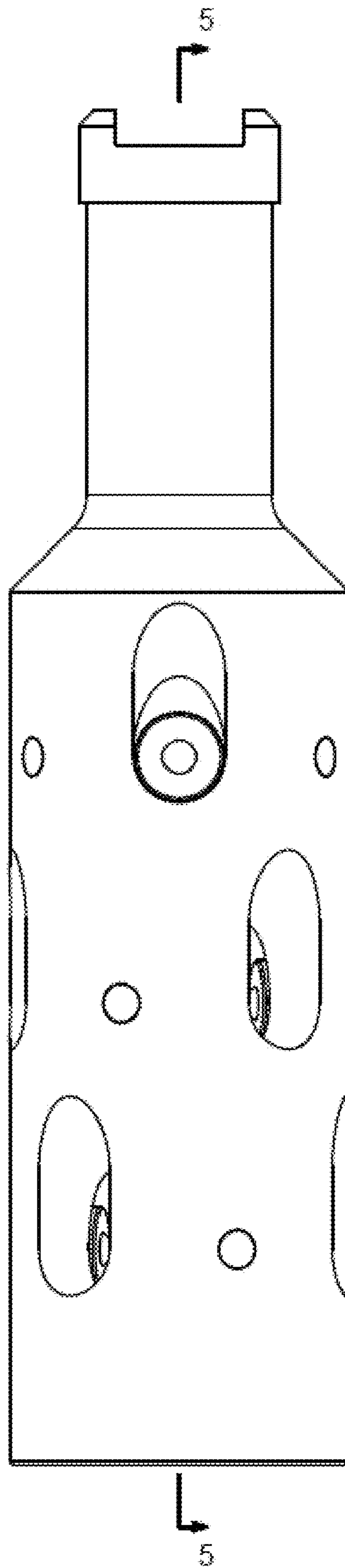

FIG. 4

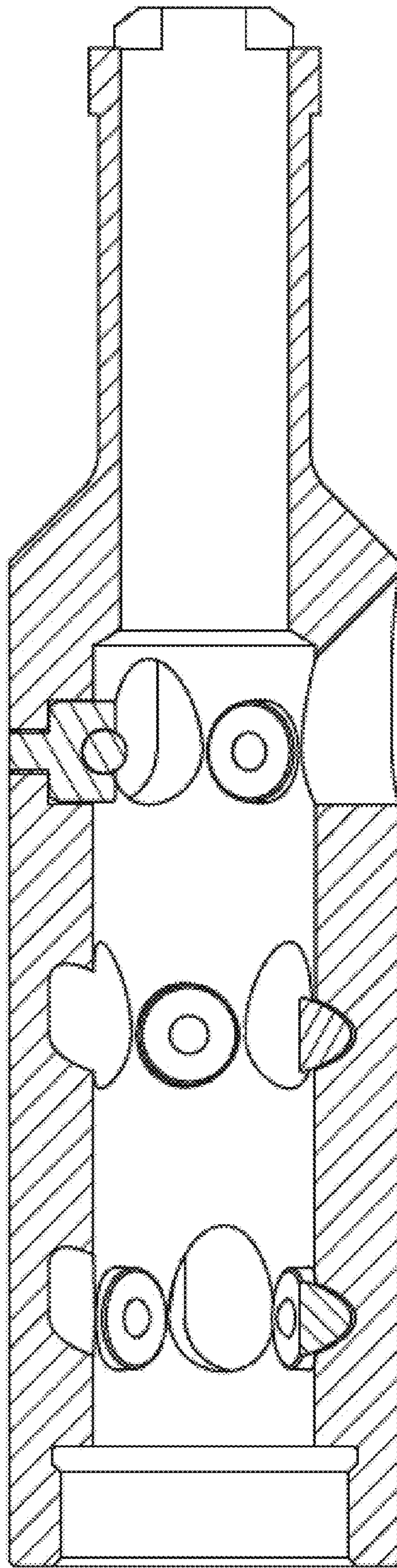

FIG. 5

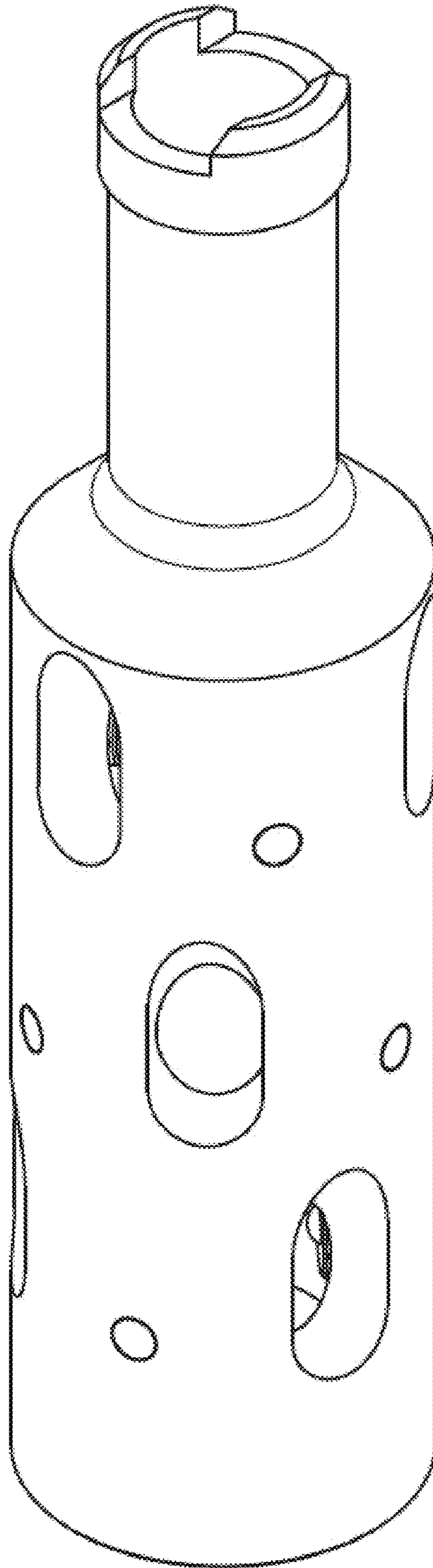

FIG. 6

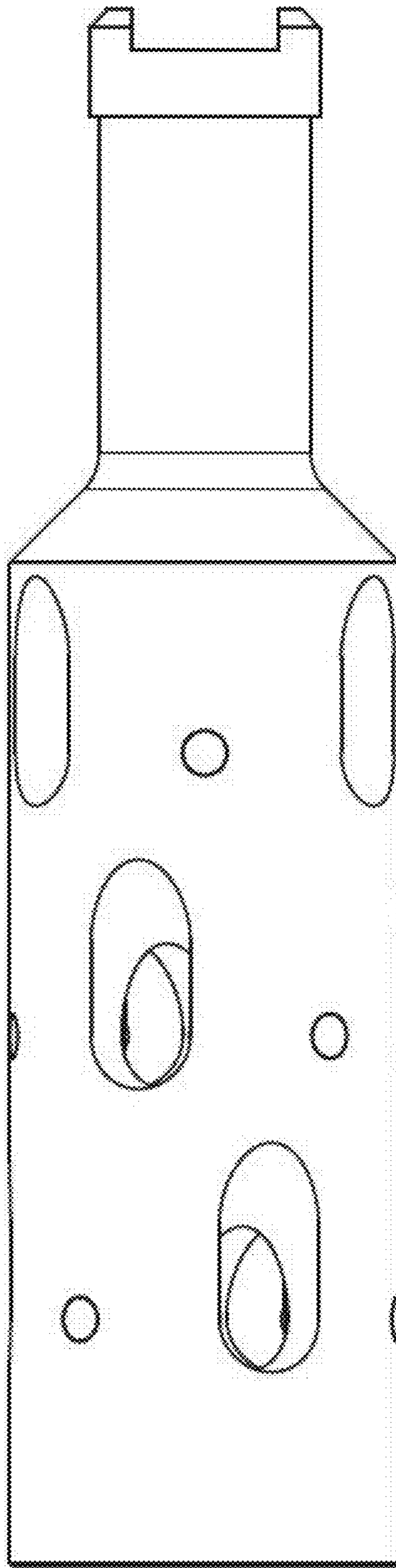

FIG. 7

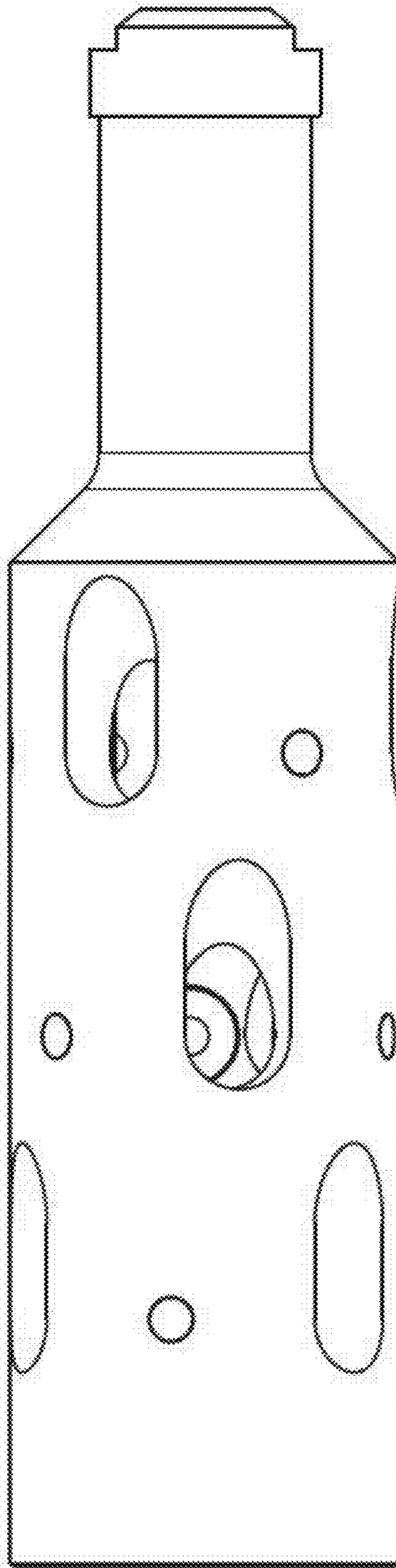

FIG. 8