



US00D917457S

(12) **United States Design Patent**
Liu et al.

(10) **Patent No.:** **US D917,457 S**
(45) **Date of Patent:** **** Apr. 27, 2021**

(54) **NOTEBOOK COMPUTER**

(71) Applicant: **Acer Incorporated**, New Taipei (TW)

(72) Inventors: **Yao-Sheng Liu**, New Taipei (TW);
Pao-Ching Huang, New Taipei (TW)

(73) Assignee: **Acer Incorporated**, New Taipei (TW)

(**) Term: **15 Years**

(21) Appl. No.: **29/694,252**

(22) Filed: **Jun. 10, 2019**

(30) **Foreign Application Priority Data**

Dec. 17, 2018 (TW) 107307367

(51) **LOC (13) Cl.** **14-02**

(52) **U.S. Cl.**
USPC **D14/315**

(58) **Field of Classification Search**
USPC D14/150, 168, 203.4, 203.6, 247,
D14/315-327, 331, 345-346, 371, 376,
(Continued)

(56) **References Cited**

U.S. PATENT DOCUMENTS

D397,855 S * 9/1998 Clarke D2/972
D428,635 S * 7/2000 Nagai D21/759
(Continued)

FOREIGN PATENT DOCUMENTS

CN 305250277 * 7/2019
CN 305401940 * 10/2019
(Continued)

OTHER PUBLICATIONS

Predator Triton 500 Laptop, Acer, acer.com, author unlisted, published on Apr. 14, 2020 per wayback machine © 2020 Acer, Inc.,

online, site visited Sep. 23, 2020. Available at URL: <https://www.acer.com/ac/en/US/content/predator-series/predatortriton500> (Year: 2020).*

Primary Examiner — Marissa J Cash
Assistant Examiner — Altaira J Swangin
(74) *Attorney, Agent, or Firm* — JCIPRNET

(57) **CLAIM**

The ornamental design for a notebook computer, as shown and described.

DESCRIPTION

FIG. 1 is a perspective view of a notebook computer showing our new design;
FIG. 2 is another perspective view thereof;
FIG. 3 is another perspective view thereof;
FIG. 4 is a front view thereof;
FIG. 5 is a rear view thereof;
FIG. 6 is a left side view thereof;
FIG. 7 is a right side view thereof;
FIG. 8 is a top view thereof;
FIG. 9 is a bottom view thereof;
FIG. 10 is an enlarged view of the portion, labeled '10' of FIG. 1;
FIG. 11 is an enlarged view of the portion, labeled '11' of FIG. 2;
FIG. 12 is an enlarged view of the portion, labeled '12' of FIG. 3;
FIG. 13 is an enlarged view of the portion, labeled '13' of FIG. 5;
FIG. 14 is an enlarged view of the portion, labeled '14' of FIG. 8; and,
FIG. 15 is an enlarged view of the portion, labeled '15' of FIG. 9.

The evenly spaced dashed broken lines in the drawings illustrate portions of the notebook computer that form no part of the claim. The dot-dashed broken lines define the bounds of the claimed design and form no part thereof The

(Continued)

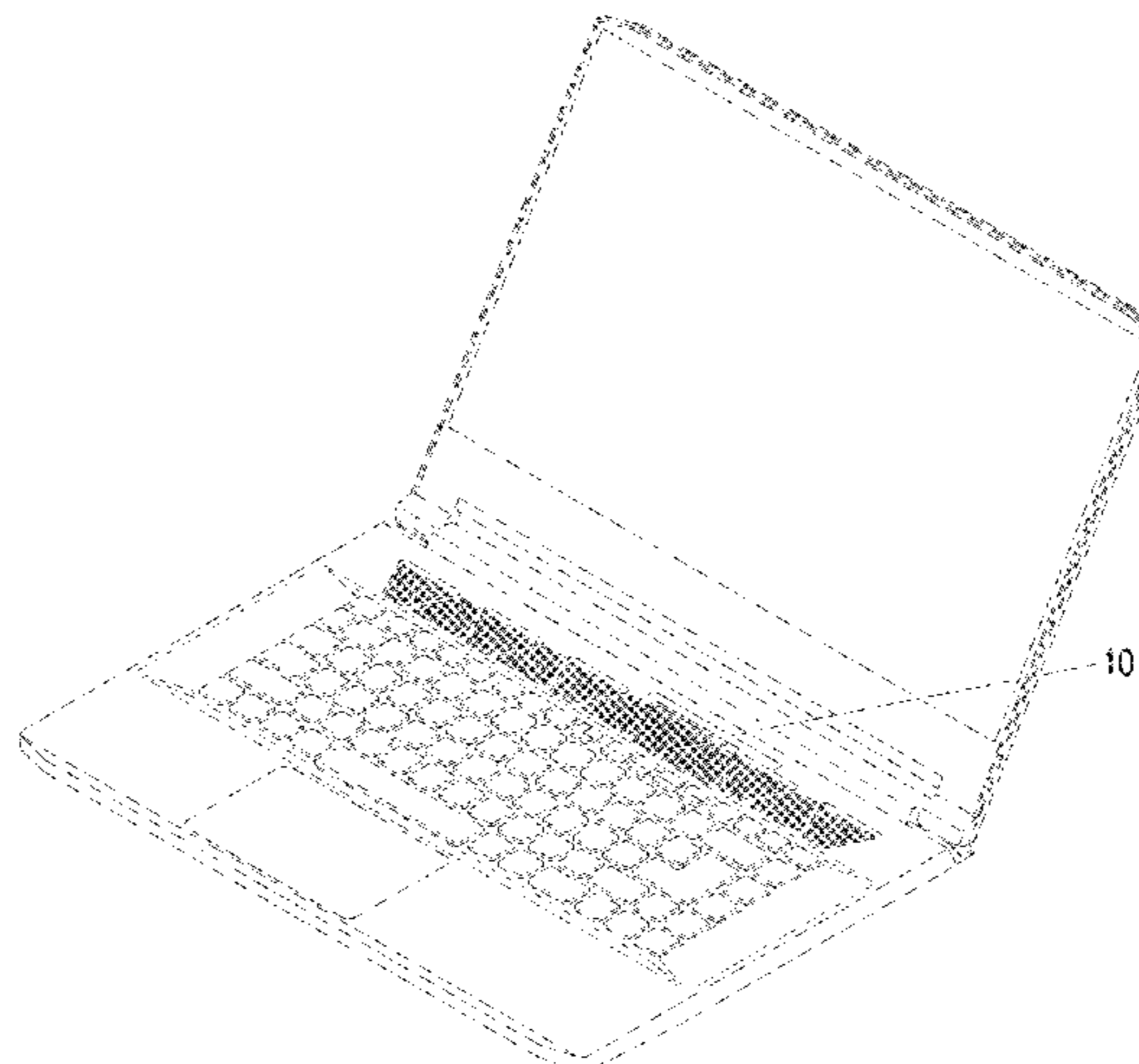

dash-dot-dot-dash lines surrounding the enlarged detail views are for annotation purposes only and form no part of the claimed design.

1 Claim, 15 Drawing Sheets

(58) **Field of Classification Search**

USPC D14/391-399, 401, 429, 434, 440,
 D14/455-457, 477, 479, 507, 509,
 D14/353-355; D3/900-901; 361/679.08,
 361/679.09, 679.11, 679.26, 679.27;
 D21/324, 409, 512, 515; D23/353-354,
 D23/366, 393, 397, 406; D2/972
 CPC B41J 5/00; B41J 5/10; B41J 5/12; G06F
 1/1664; G06F 1/1637

See application file for complete search history.

(56)

References Cited

U.S. PATENT DOCUMENTS

D517,146	S	*	3/2006	Nishitani	D21/759
D636,584	S	*	4/2011	Williams, Jr.	D2/972
D707,030	S	*	6/2014	Miner	D2/972
D713,632	S	*	9/2014	da Costa Pereira Machado	D2/972
D729,550	S	*	5/2015	Williams	D6/675
D865,757	S	*	11/2019	Townsend	D14/327
D879,790	S	*	3/2020	Donachy	D14/444
D881,873	S	*	4/2020	Li	D14/316
D897,337	S	*	9/2020	Probst	D14/324
D906,334	S	*	12/2020	Du	D14/440
2016/0212892	A1	*	7/2016	Sweet	G06F 1/1688
2017/0111739	A1	*	4/2017	Lan	G06F 3/165
2019/0208662	A1	*	7/2019	Lee	G06F 1/1624

FOREIGN PATENT DOCUMENTS

CN	305419806	*	11/2019
CN	305510018	*	12/2019
CN	305516038	*	12/2019

* cited by examiner

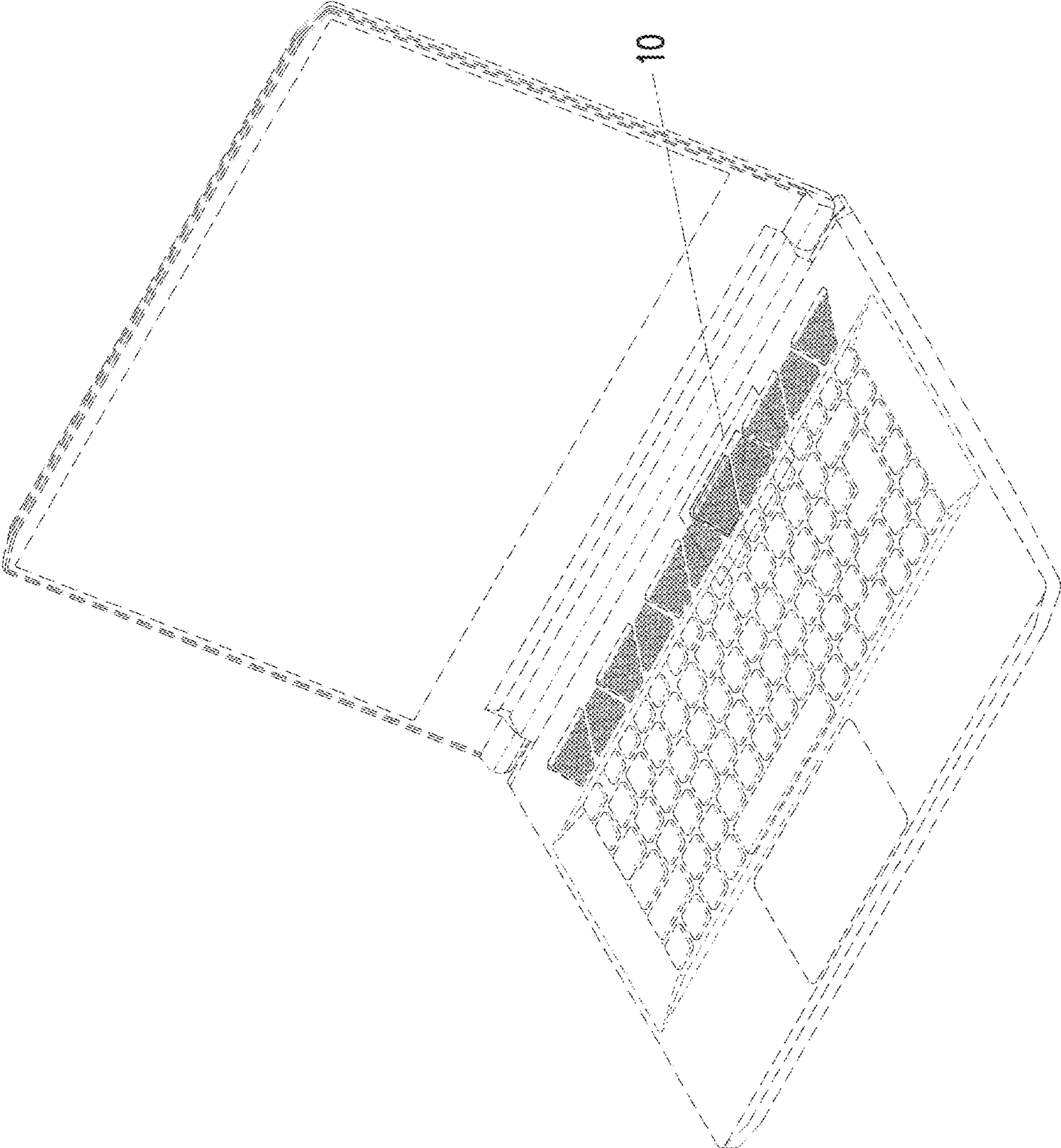

FIG. 1

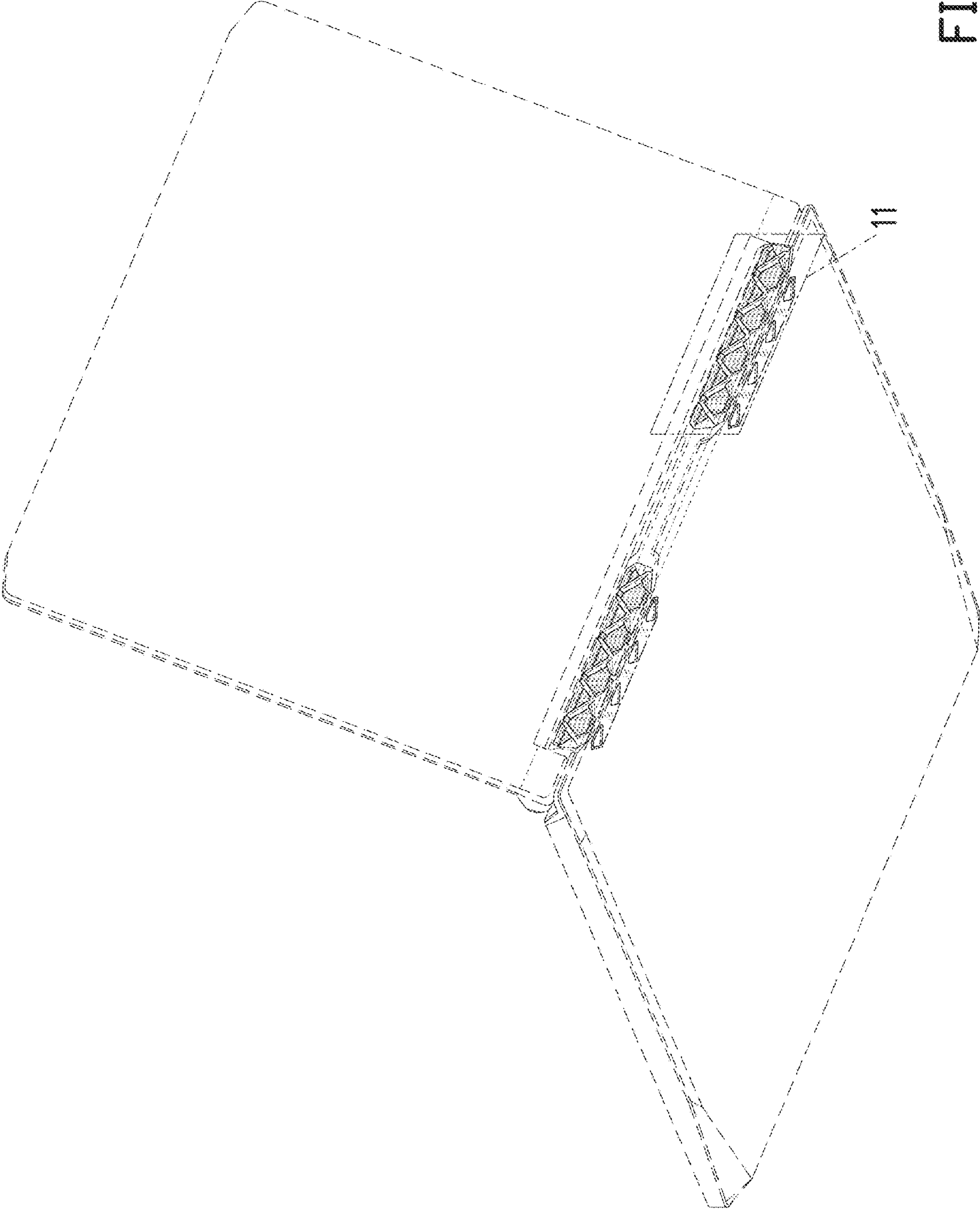

FIG. 2

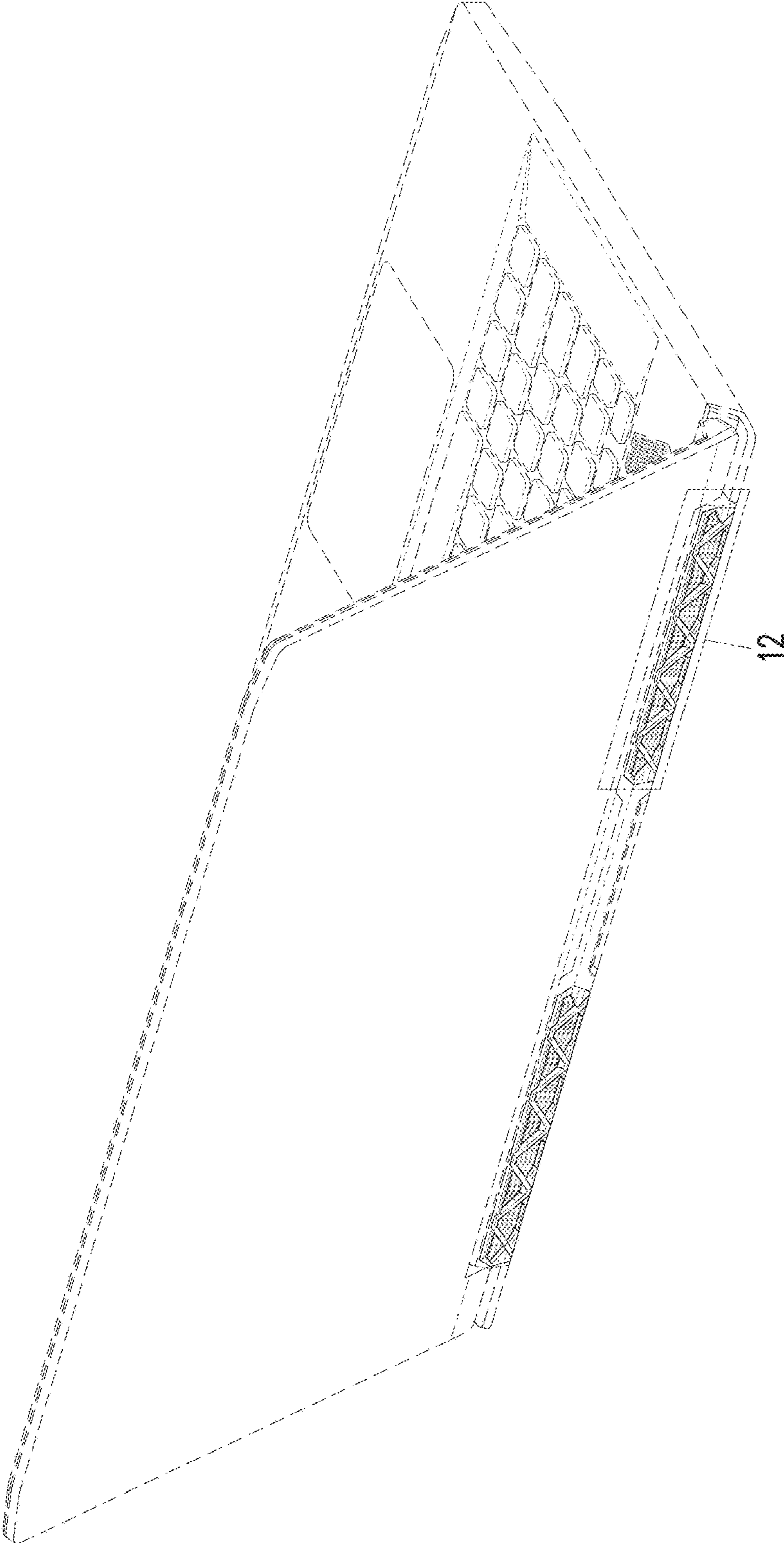

FIG. 3



FIG. 4

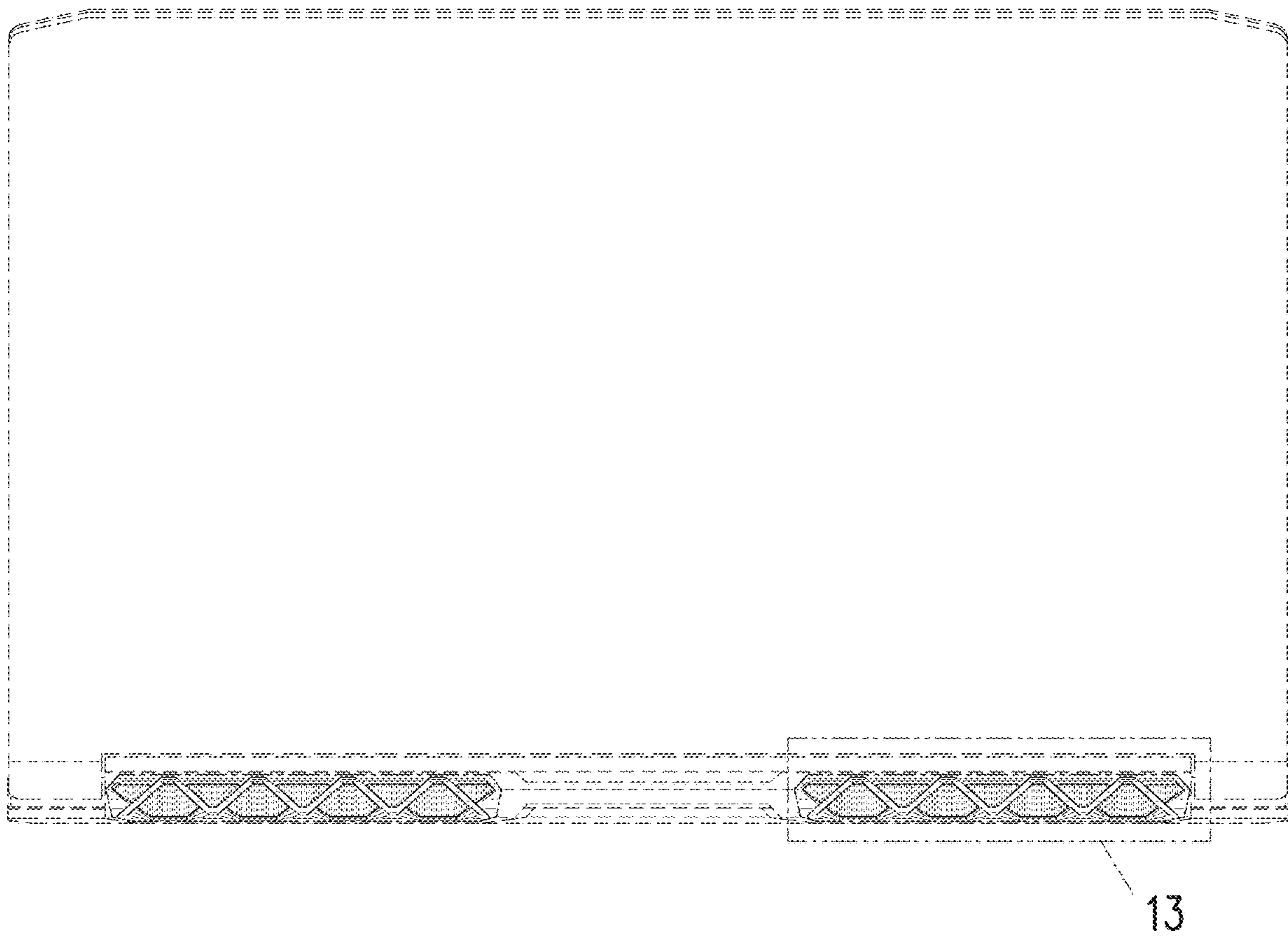

FIG. 5

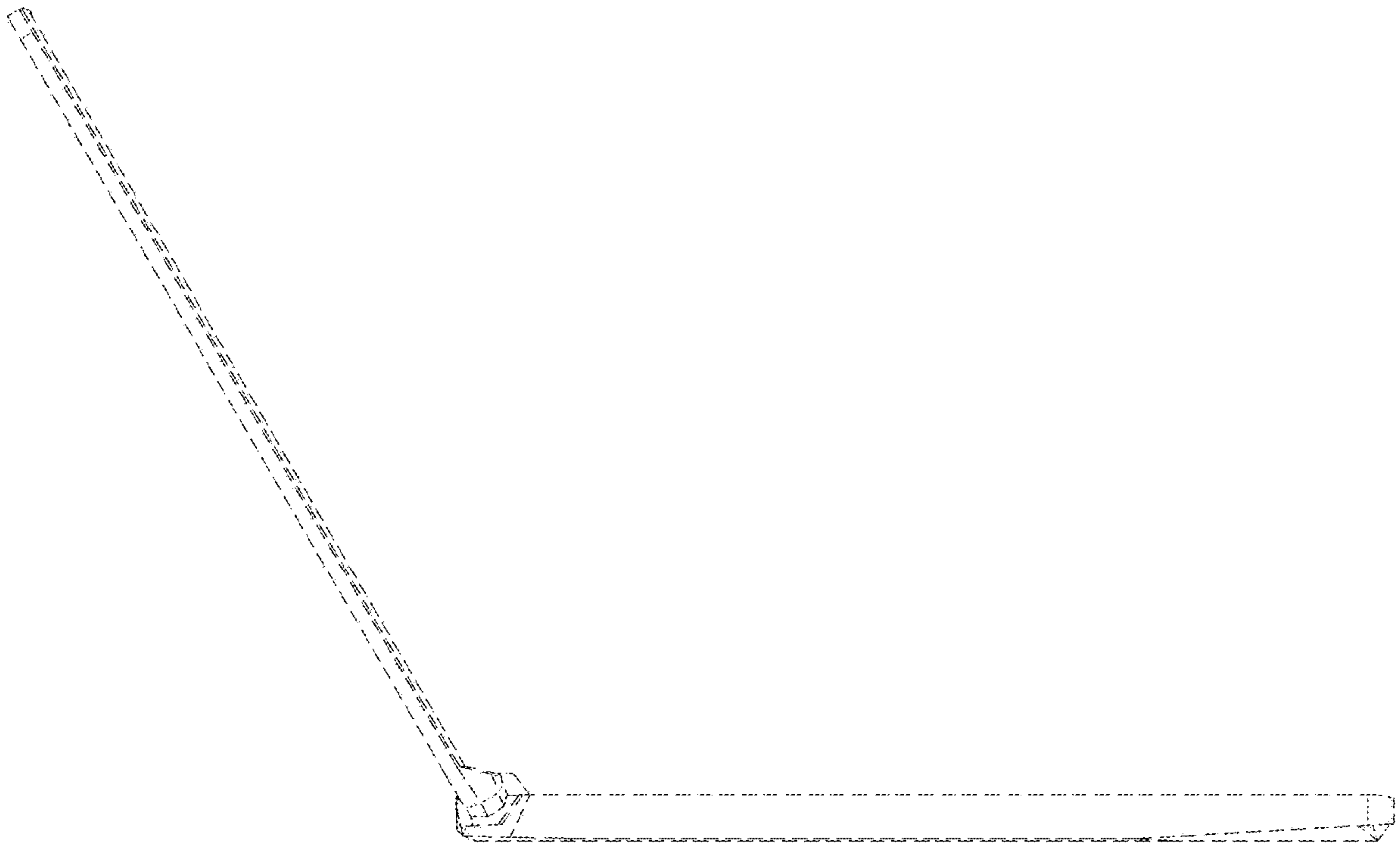

FIG. 6

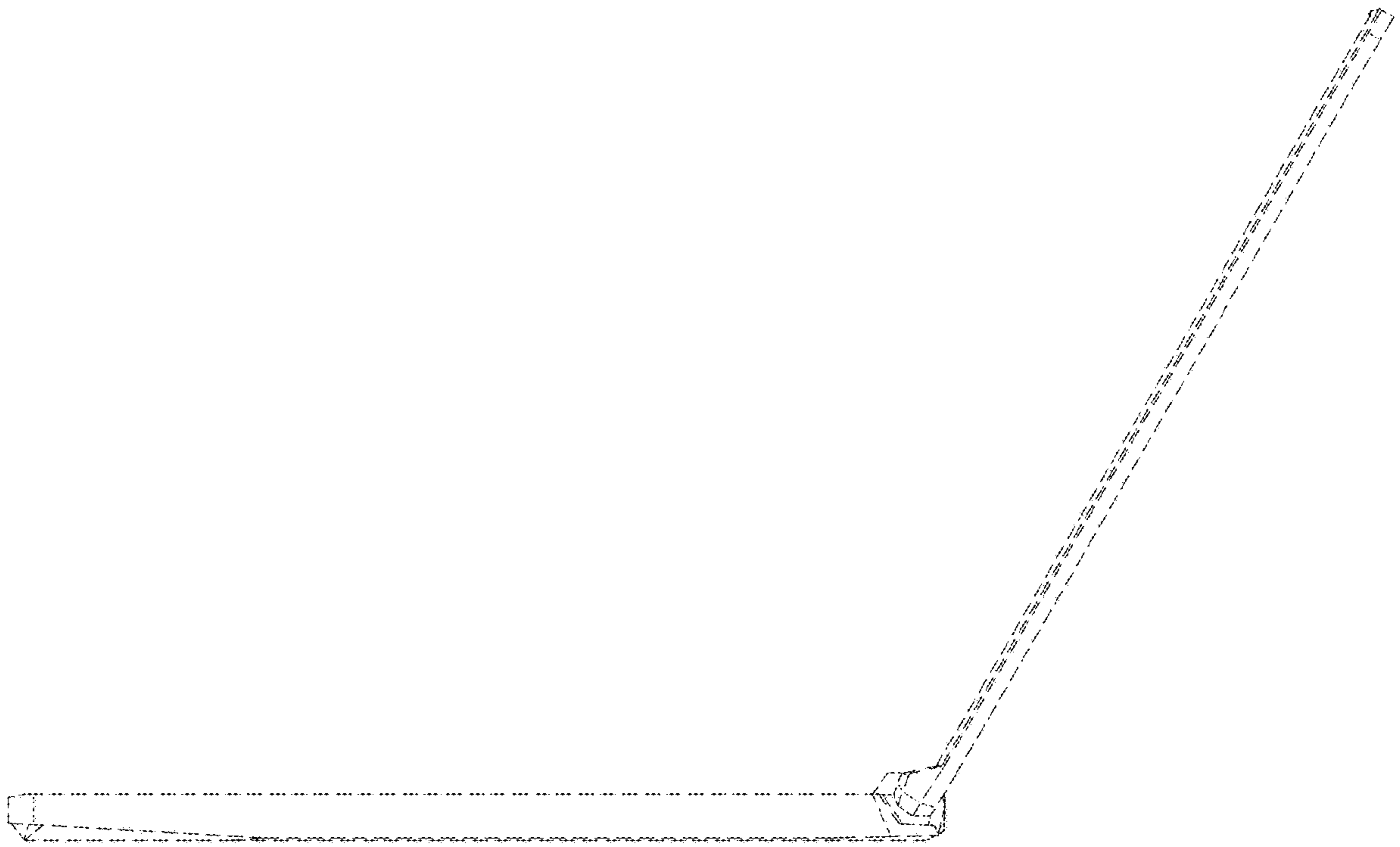

FIG. 7

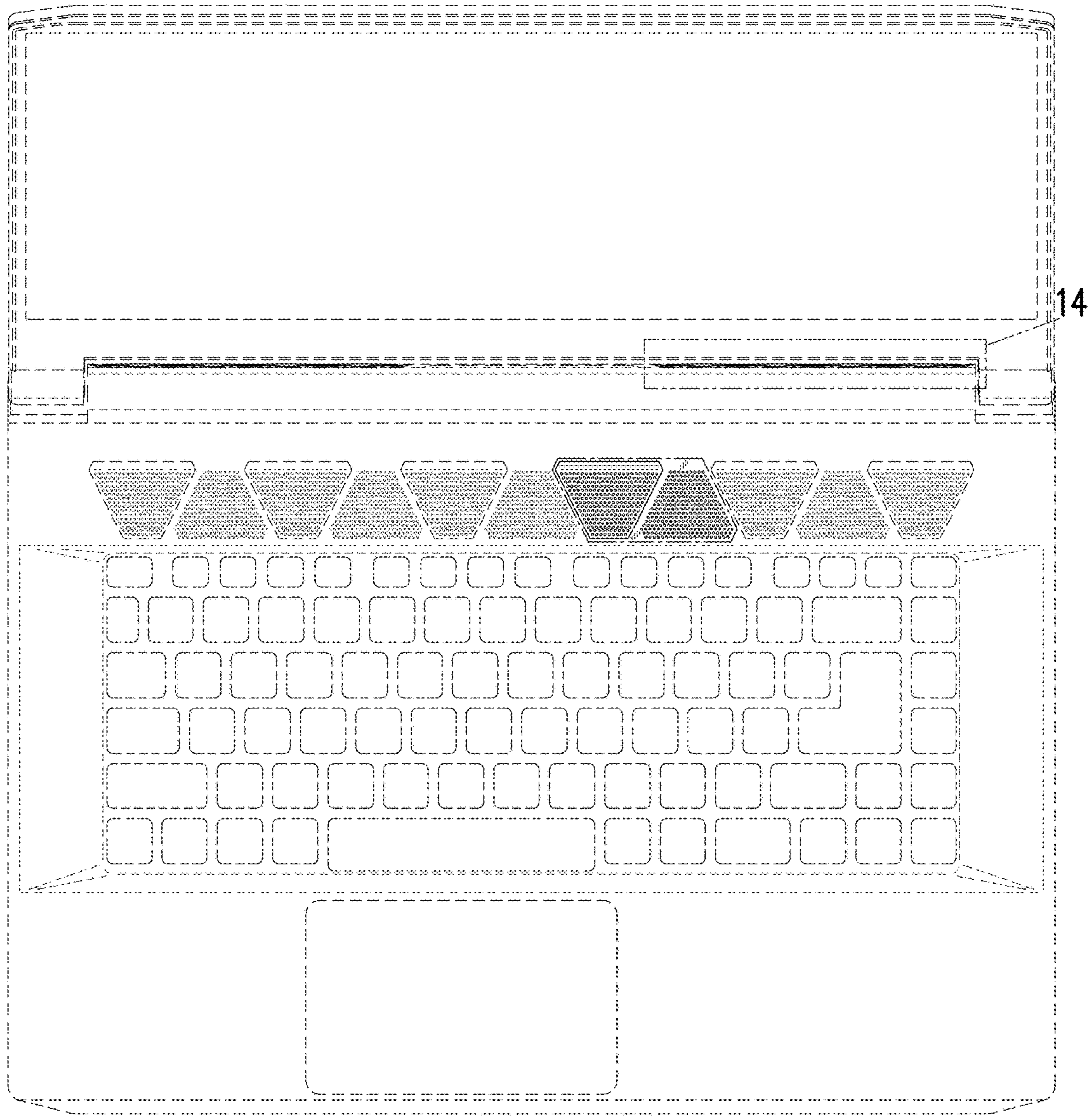

FIG. 8

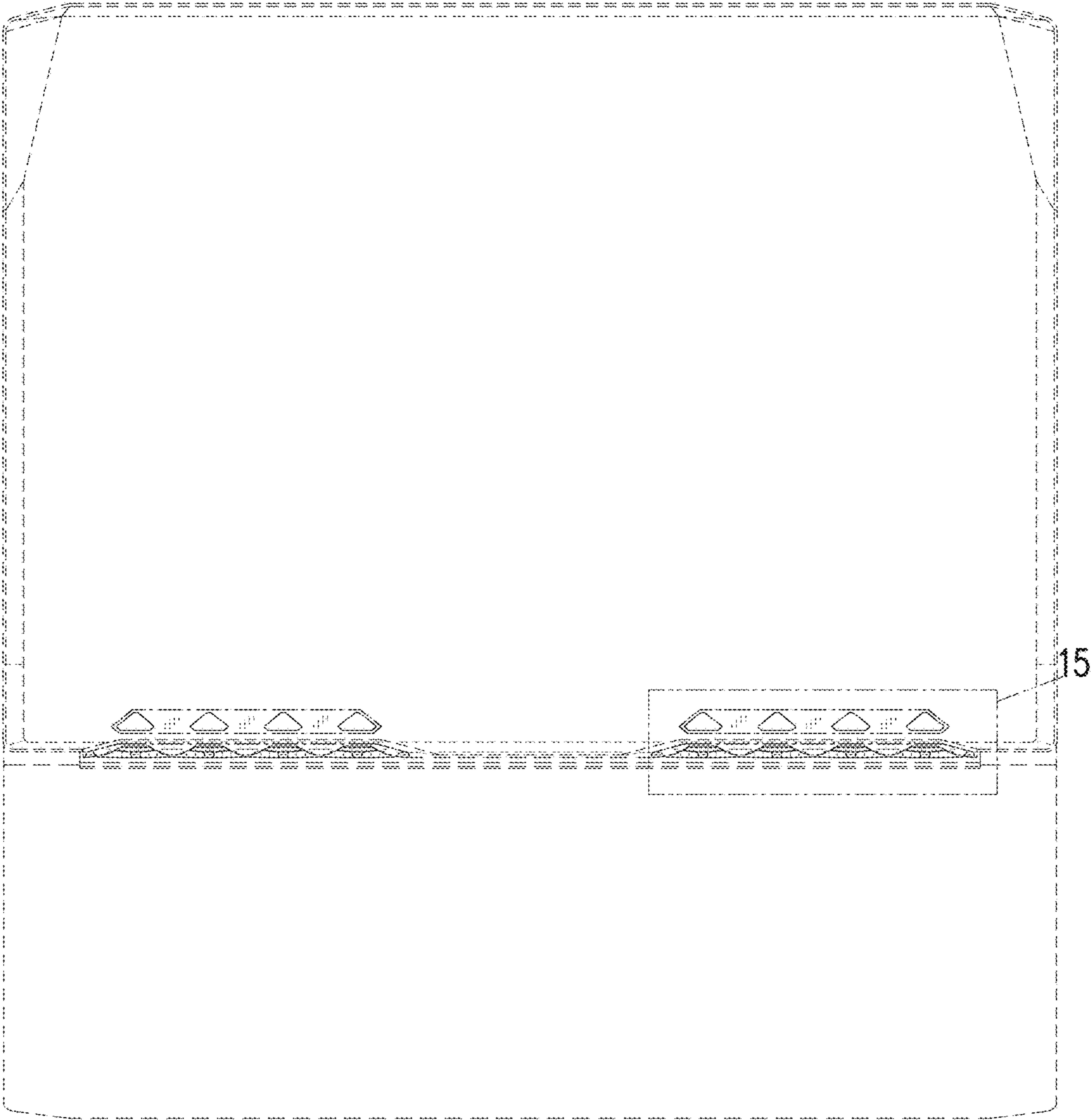

FIG. 9

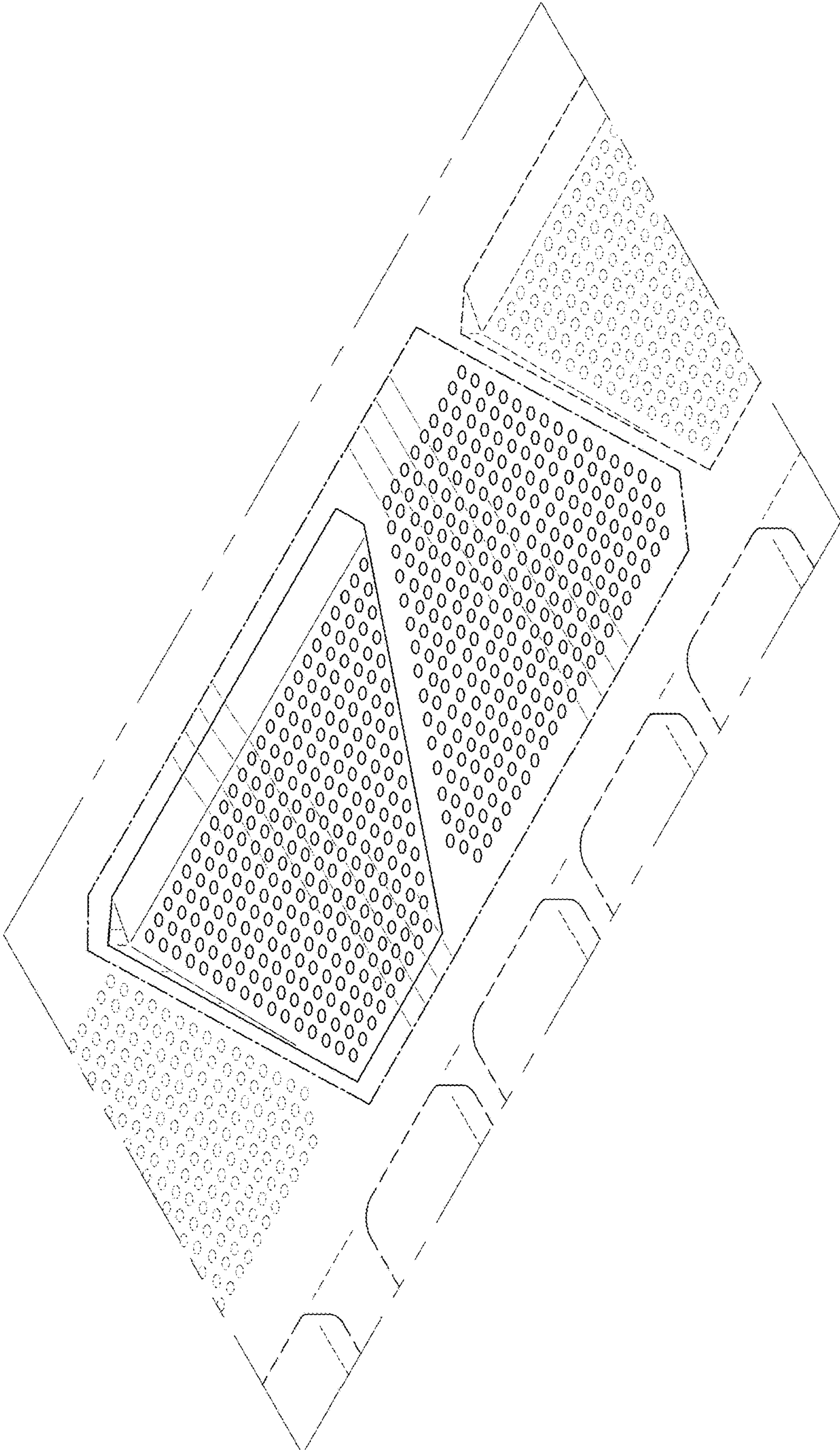

FIG. 10

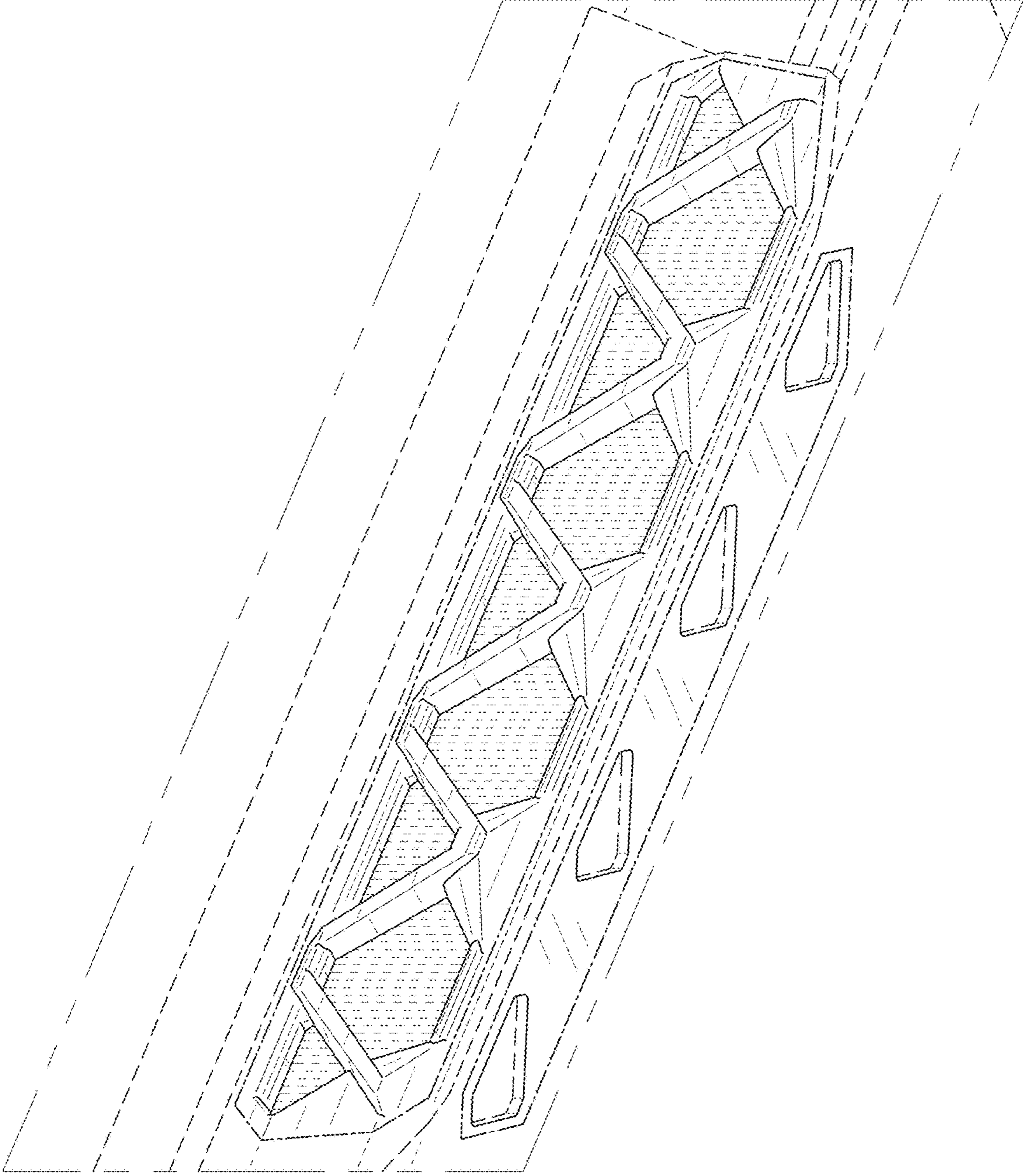

FIG. 11

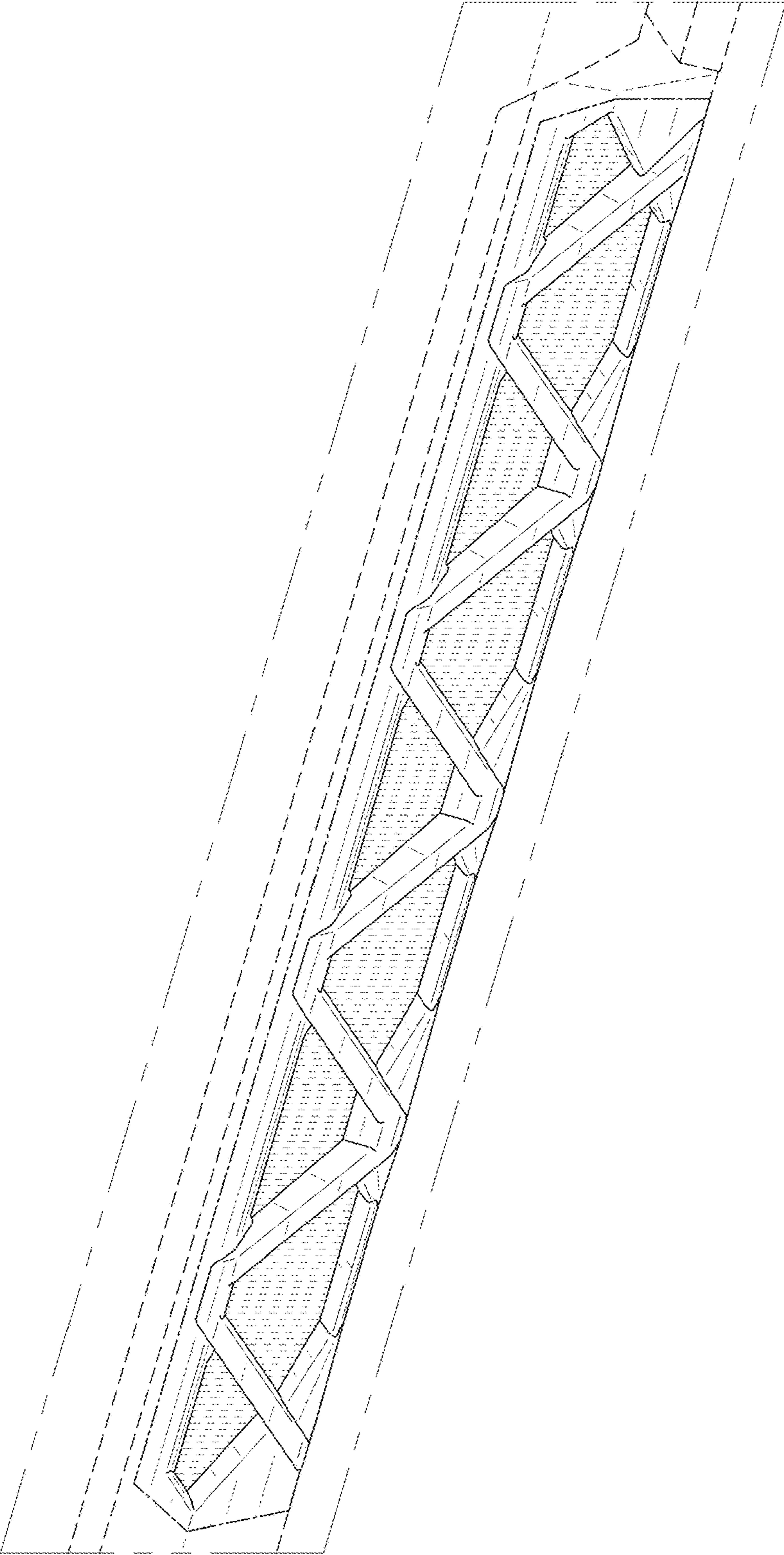

FIG. 12

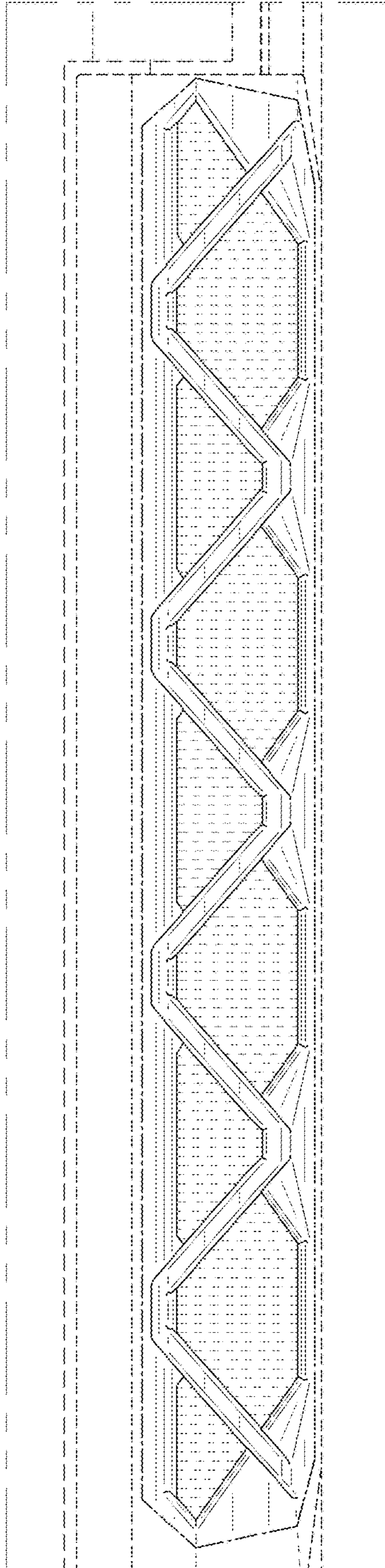

FIG. 13

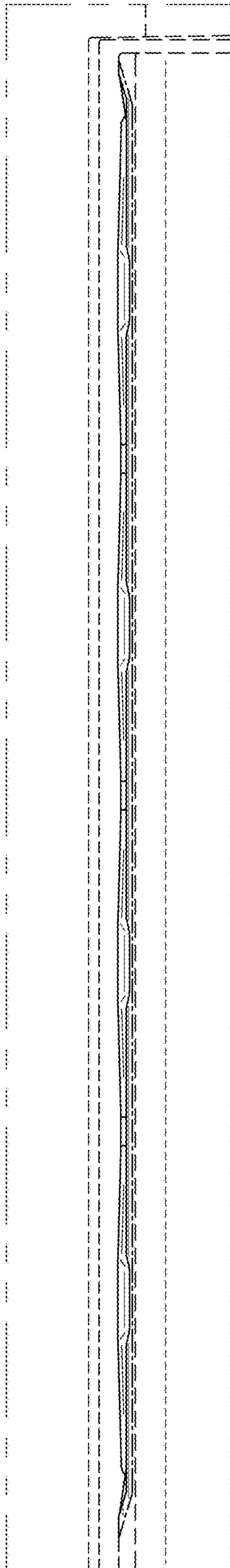

FIG. 14

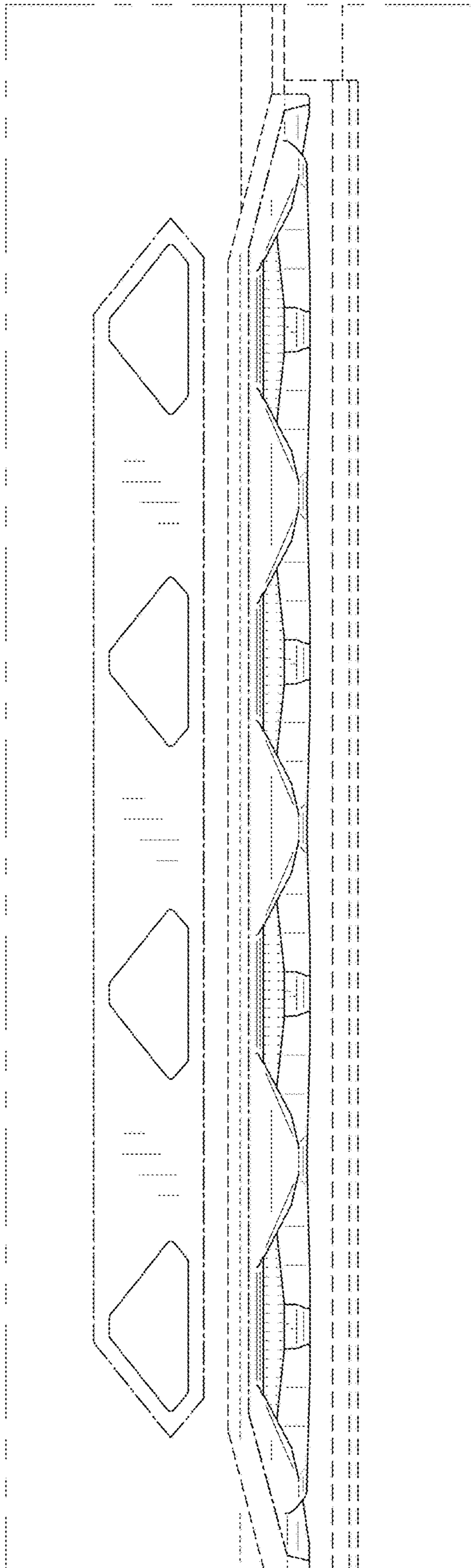

FIG. 15