



US00D917405S

(12) **United States Design Patent** (10) **Patent No.:** **US D917,405 S**  
**Kim** (45) **Date of Patent:** **\*\* Apr. 27, 2021**

(54) **SMART KEY FOR VEHICLES**  
(71) Applicant: **LG ELECTRONICS INC.**, Seoul (KR)  
(72) Inventor: **Byungkyu Kim**, Seoul (KR)  
(73) Assignee: **LG Electronics Inc.**, Seoul (KR)  
(\*\*) Term: **15 Years**

D687,787 S \* 8/2013 Chin ..... D13/168  
D688,215 S \* 8/2013 Yu ..... D13/168  
D688,635 S \* 8/2013 Ni ..... D13/168  
D692,400 S \* 10/2013 Ni ..... D13/168  
D725,607 S \* 3/2015 Kandler ..... D13/168  
D726,129 S \* 4/2015 Chin ..... D13/168  
D733,074 S \* 6/2015 Kandler ..... D13/168  
D844,574 S \* 4/2019 Kandler ..... D13/168

(21) Appl. No.: **35/508,792**  
(22) Filed: **Sep. 9, 2019**

**FOREIGN PATENT DOCUMENTS**

CN 304851445 \* 10/2018  
CN 304851450 \* 10/2018  
JP D1664625 \* 7/2020

(80) **Hague Agreement Data**  
Int. Filing Date: **Sep. 9, 2019**  
Int. Reg. No.: **DM/204733**  
Int. Reg. Date: **Sep. 9, 2019**  
Int. Reg. Pub. Date: **Mar. 13, 2020**

\* cited by examiner

*Primary Examiner* — Deanna L Pratt  
(74) *Attorney, Agent, or Firm* — Birch, Stewart, Kolasch & Birch, LLP

(30) **Foreign Application Priority Data**

Mar. 22, 2019 (KR) ..... 30-2019-0013150

(57) **CLAIM**

The ornamental design for a smart key for vehicles, as shown and described.

(51) **LOC (13) Cl.** ..... **14-03**  
(52) **U.S. Cl.**  
USPC ..... **D13/168**  
(58) **Field of Classification Search**  
USPC ..... D10/104.1, 106.1, 106.9; D8/347;  
D13/168; D14/435, 218; D12/400  
CPC ..... G07C 2009/00984; E05B 19/0085  
See application file for complete search history.

**DESCRIPTION**

- 1. Smart key for vehicles
- 1.1 : Perspective
- 1.2 : Front
- 1.3 : Back
- 1.4 : Left
- 1.5 : Right
- 1.6 : Top
- 1.7 : Bottom
- 1.8 : Reference

The claimed design is an artificial intelligence smart key for vehicles that is connected to docking stations in a vehicle or at home, and displays home or vehicles information on the top display; reproduction 1.8 is a reference view showing a state of use in which a smart key is connected to a docking station; the broken lines showing the docking station in reproduction 1.8 form no part of the claimed design.

(56) **References Cited**

**U.S. PATENT DOCUMENTS**

D578,967 S \* 10/2008 Kumano ..... D13/168  
D584,241 S \* 1/2009 To ..... D13/168  
D584,242 S \* 1/2009 Lacour ..... D13/168  
D590,779 S \* 4/2009 Lacour ..... D13/168  
D639,547 S \* 6/2011 Stefanov ..... D3/207  
D662,066 S \* 6/2012 Seidl ..... D13/168

**1 Claim, 8 Drawing Sheets**

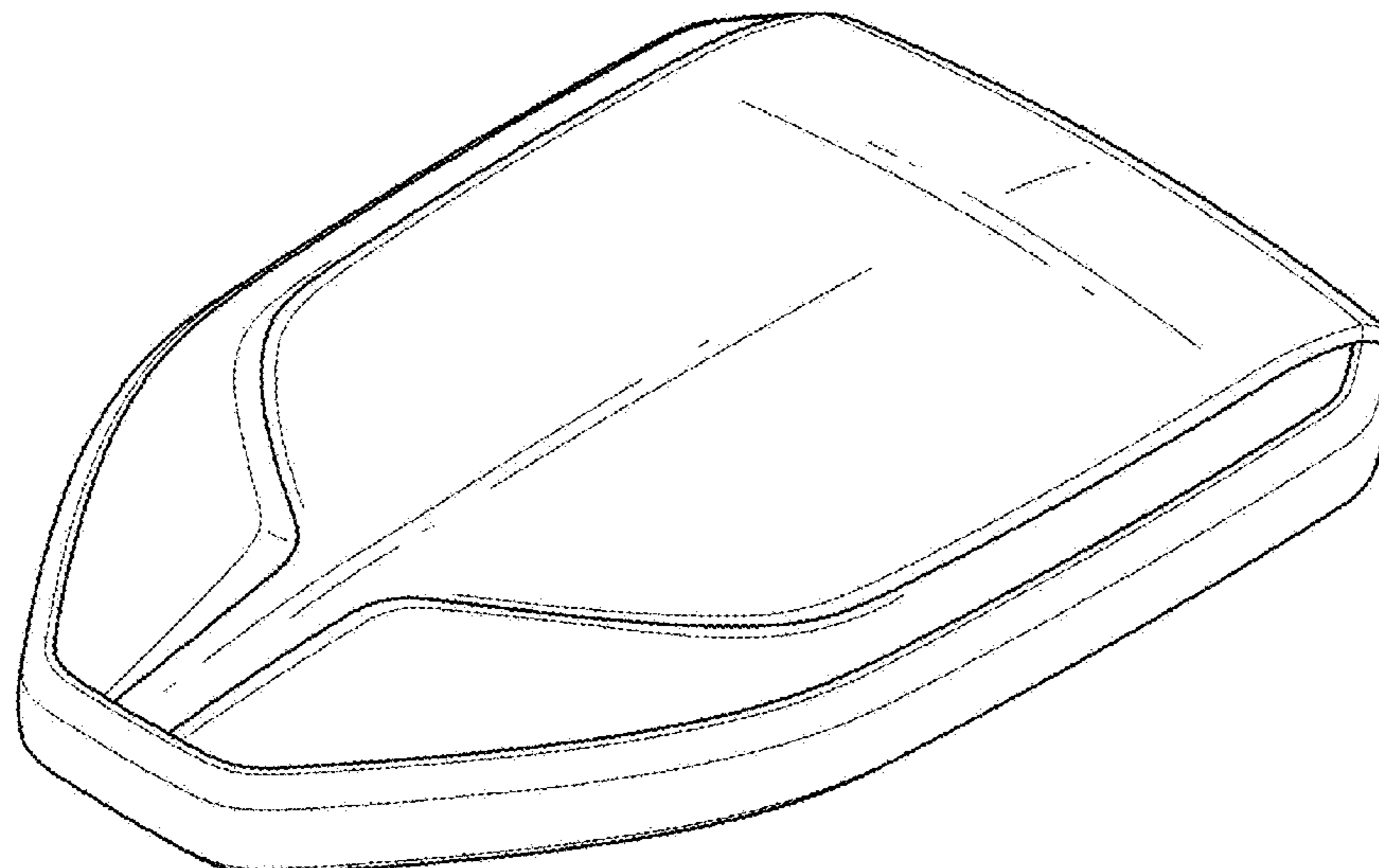

1.1

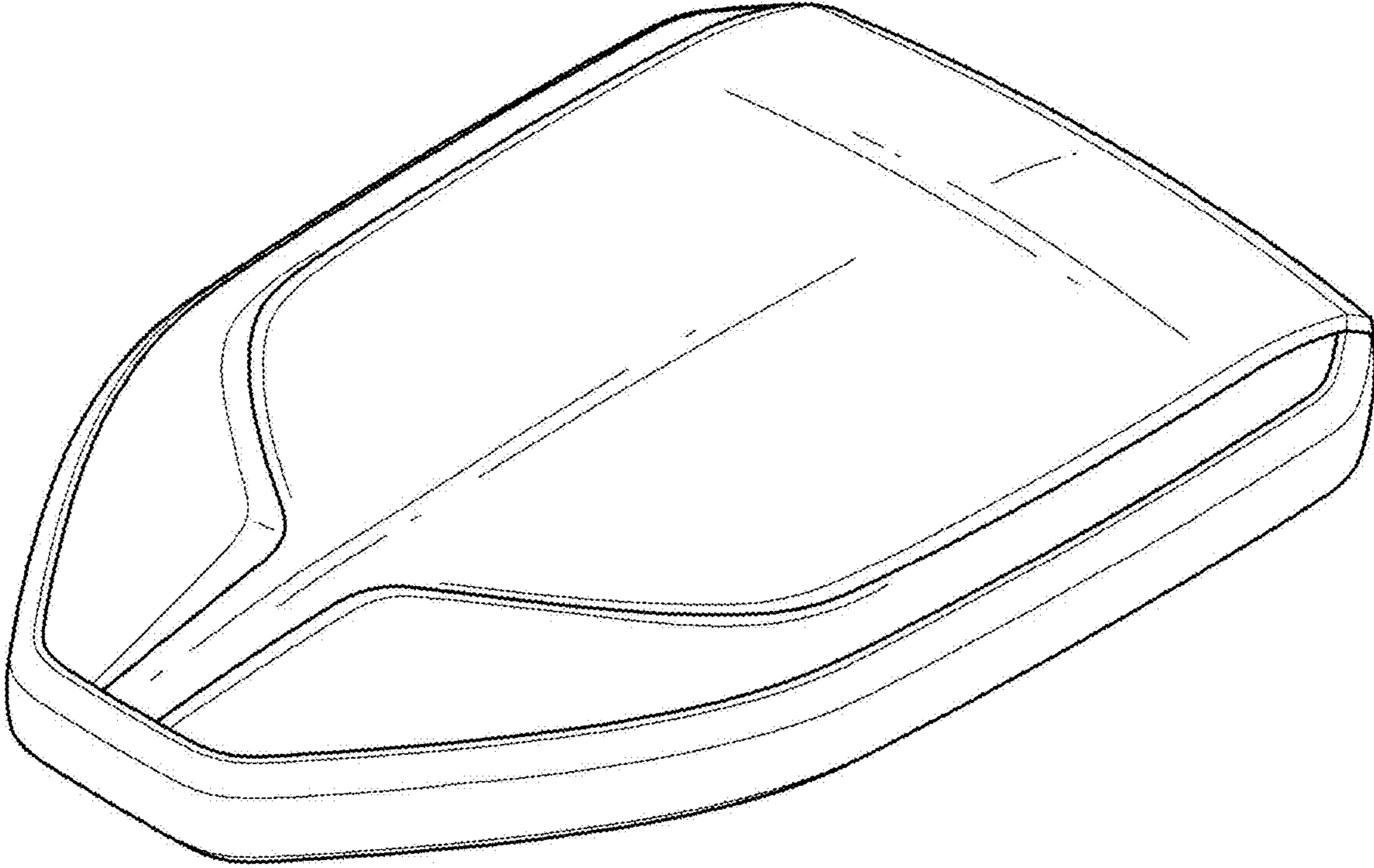

1.2

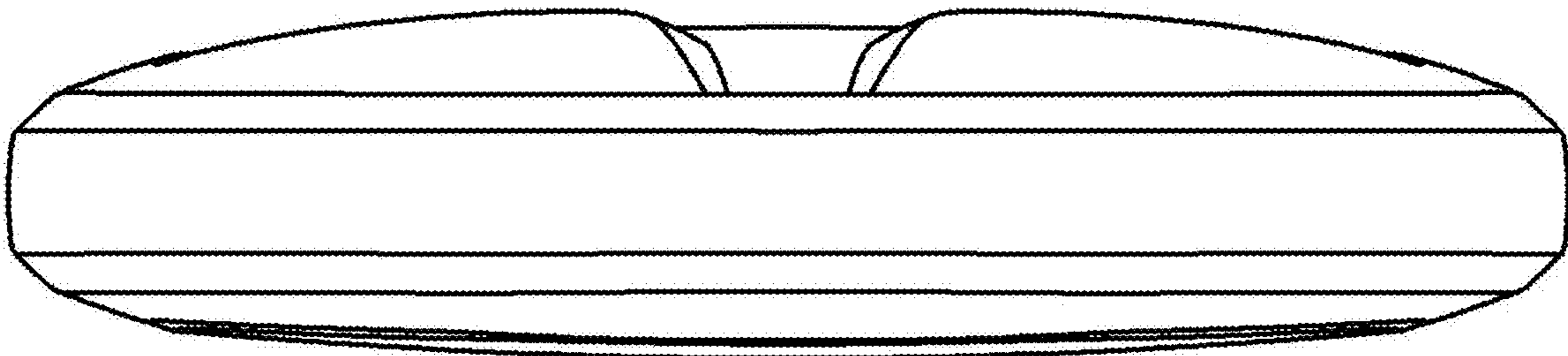

1.3

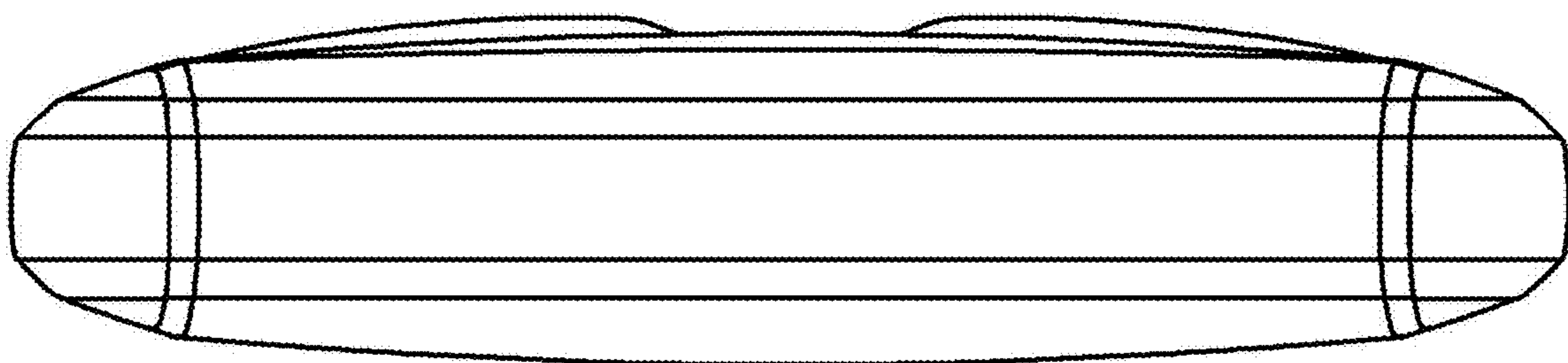

1.4

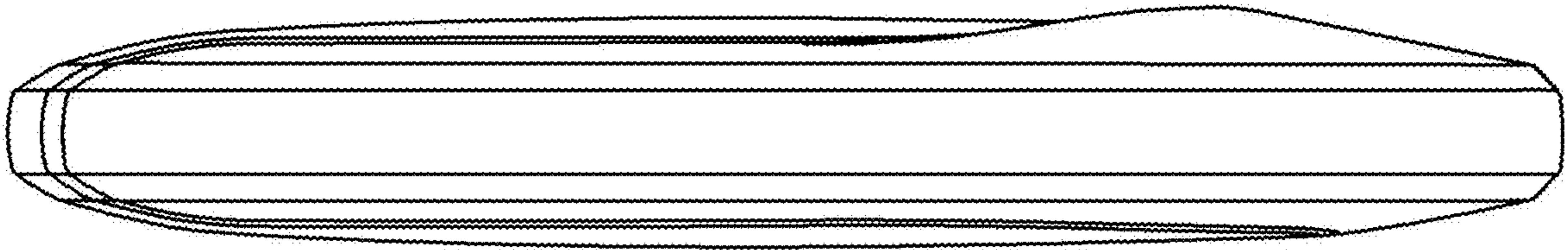

1.5

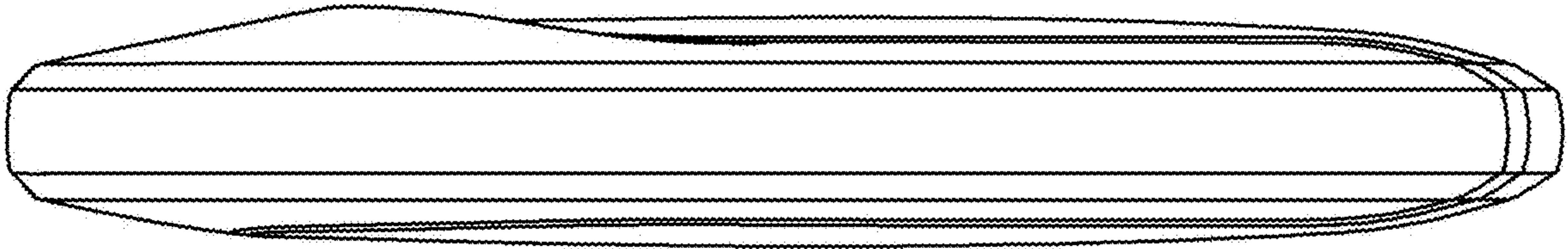

1.6

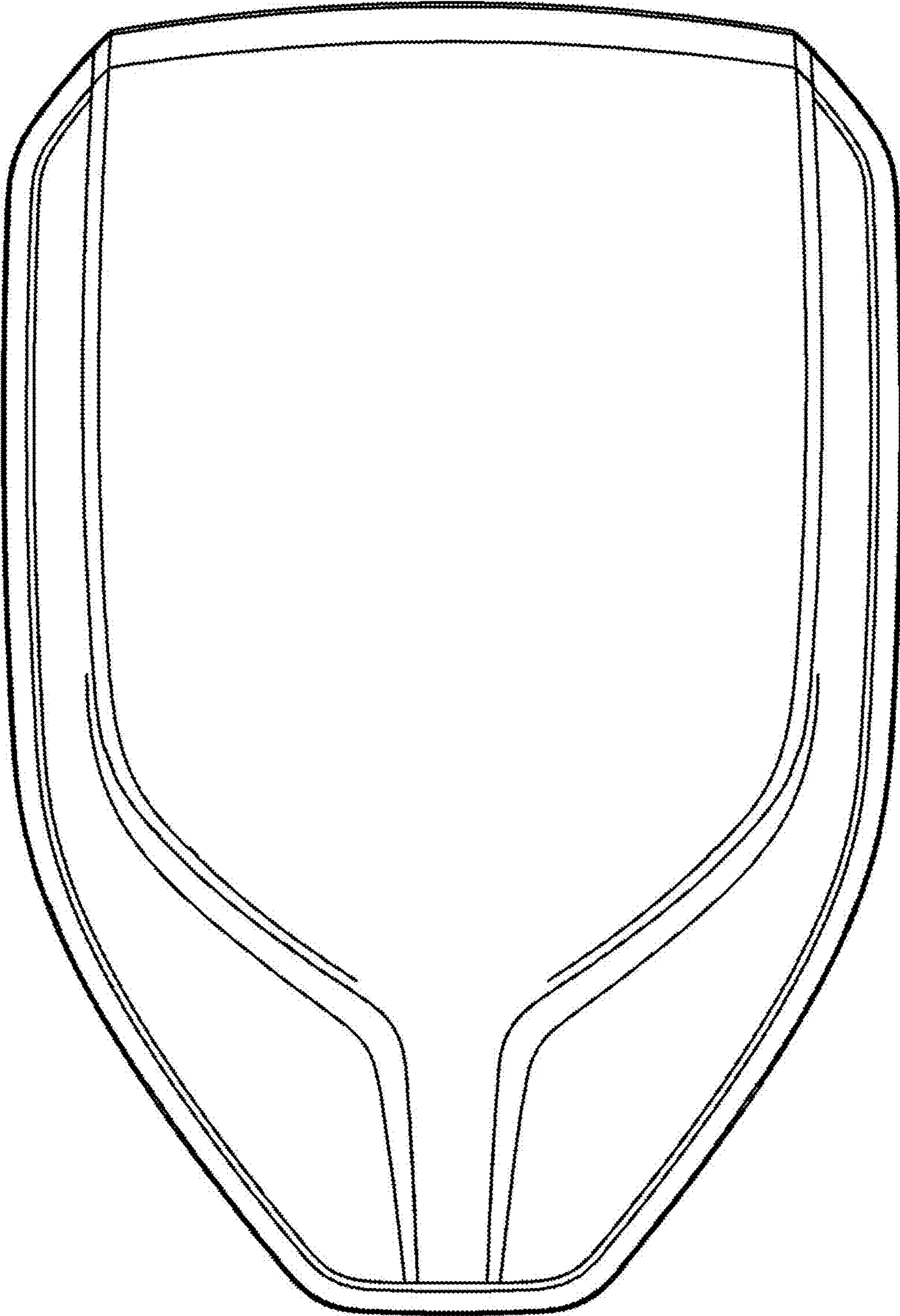

1.7

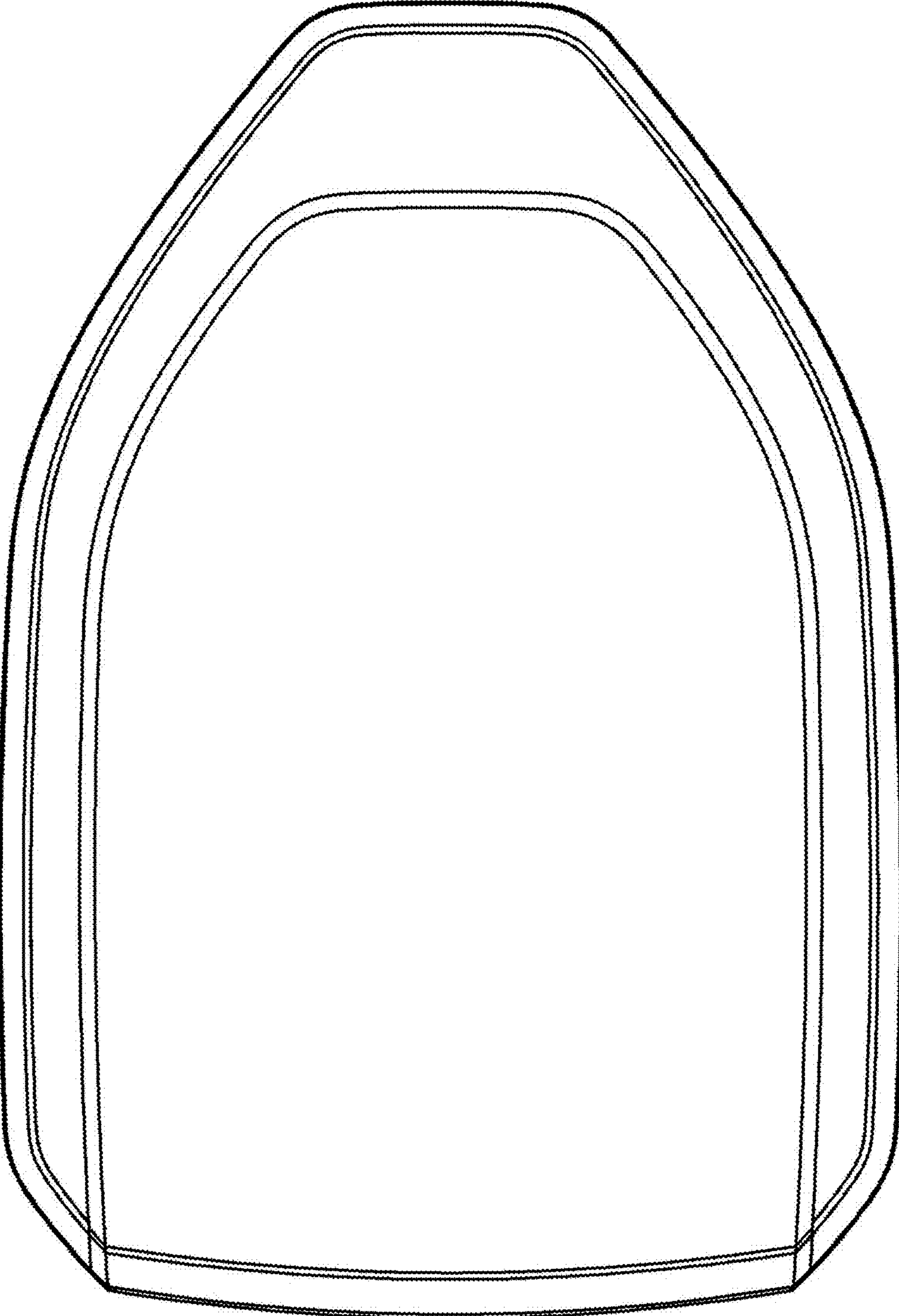



1.8

