



US00D917205S

(12) **United States Design Patent** (10) **Patent No.:** **US D917,205 S**
Stern (45) **Date of Patent:** **** Apr. 27, 2021**

(54) **PADDED SEAT**
(71) Applicant: **Babyroo Ltd.**, Even Yehuda (IL)
(72) Inventor: **Hezi Stern**, Even Yehuda (IL)
(73) Assignee: **BABYROO LTD.**, Even Yehuda (IL)
(**) Term: **15 Years**
(21) Appl. No.: **29/682,055**
(22) Filed: **Mar. 1, 2019**
(51) **LOC (13) Cl.** **06-09**
(52) **U.S. Cl.**
USPC **D6/601**
(58) **Field of Classification Search**
USPC D6/595-601, 604, 606; D24/183, 190;
D21/803, 809; D2/501
CPC A47C 20/00; A47C 20/021; A47C 7/742;
A47C 7/021; A47D 15/001; A47D
15/008; A47G 9/00; A47G 9/10; B62J
1/26
See application file for complete search history.

(56) **References Cited**
U.S. PATENT DOCUMENTS
5,594,954 A * 1/1997 Huang A41D 13/065
2/16
6,253,376 B1 * 7/2001 Ritter A41D 13/065
2/24
D453,976 S * 2/2002 Slutterback D29/121.1

D492,068 S * 6/2004 Peterson D29/121.1
D804,849 S * 12/2017 Stern D6/596
2012/0025576 A1 * 2/2012 Stern F16F 1/26
297/344.1
2020/0187575 A1 * 6/2020 Hollis A41D 13/0568

* cited by examiner

Primary Examiner — Jennifer L Rempfer
(74) *Attorney, Agent, or Firm* — The IP Law Firm of Guy Levi, LLC

(57) **CLAIM**

The ornamental design for a padded seat, as shown and described herein.

DESCRIPTION

FIG. 1, is a front top right perspective view of the padded seat, showing my new design;
FIG. 2, is a right side elevation view thereof, the left side being a mirror image thereof;
FIG. 3, is a front elevation view thereof, the rear side elevation being a mirror image thereof;
FIG. 4, is a top plan view thereof;
FIG. 5, is a bottom plan view thereof;
FIG. 6, is a bottom right perspective view thereof; and,
FIG. 7, is cross section view of the right side elevation view of FIG. 2.

The stippling on the seat padding in FIGS. 1-7, represents surface texture different that the non-stippled sections, where a change in the density of stippling denotes a gradation of the texture of that portion of the seat padding.

1 Claim, 7 Drawing Sheets

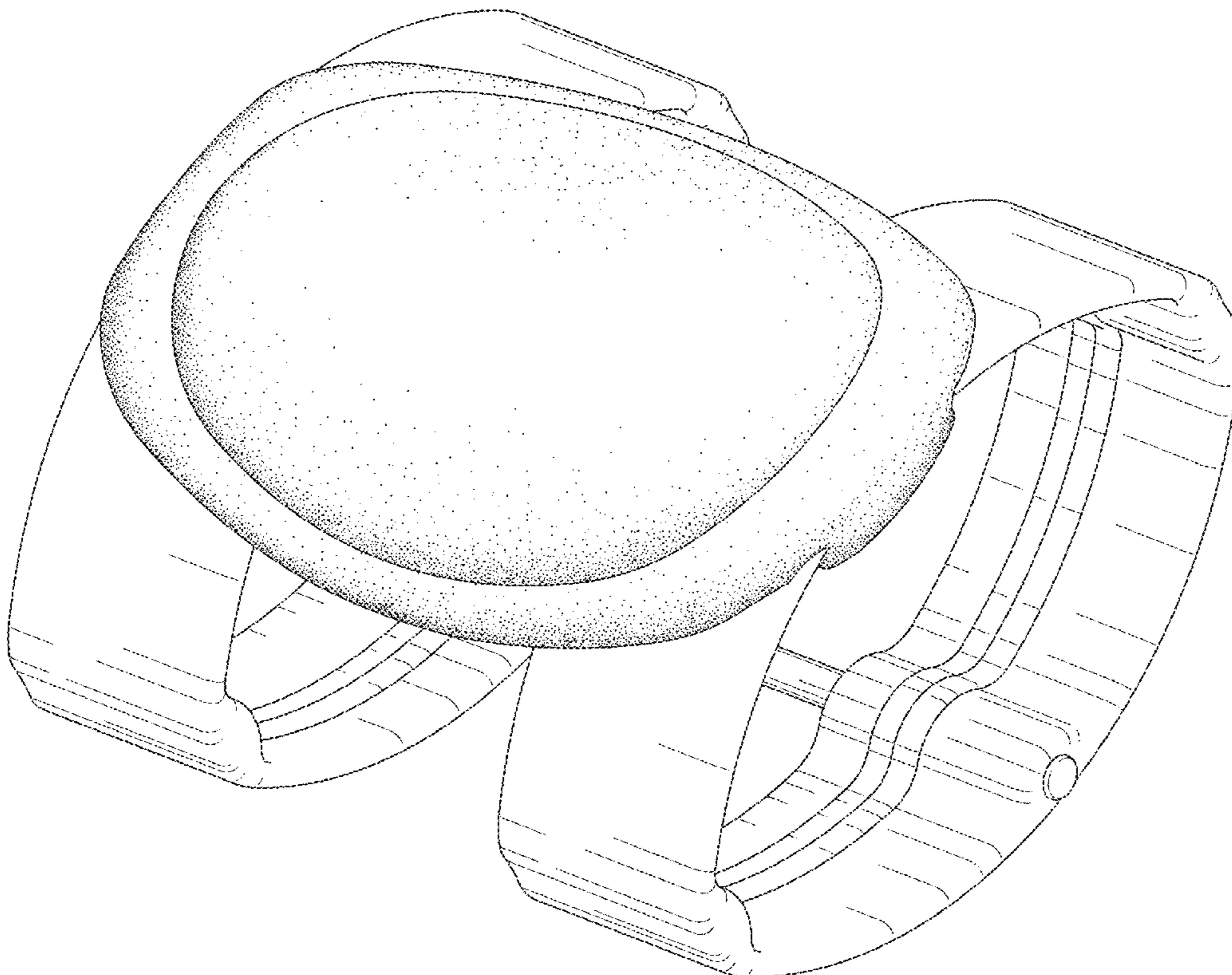

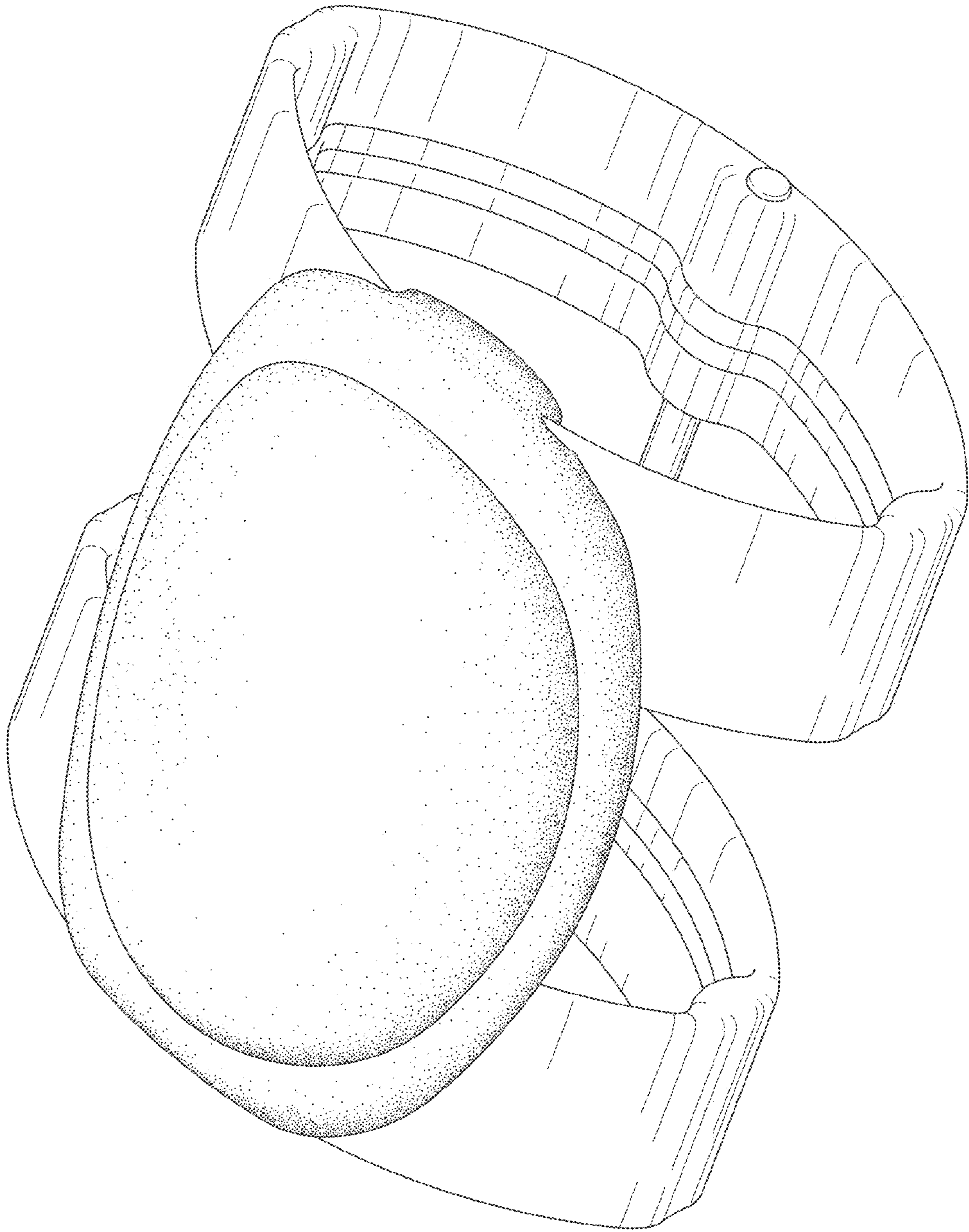

FIG. 1

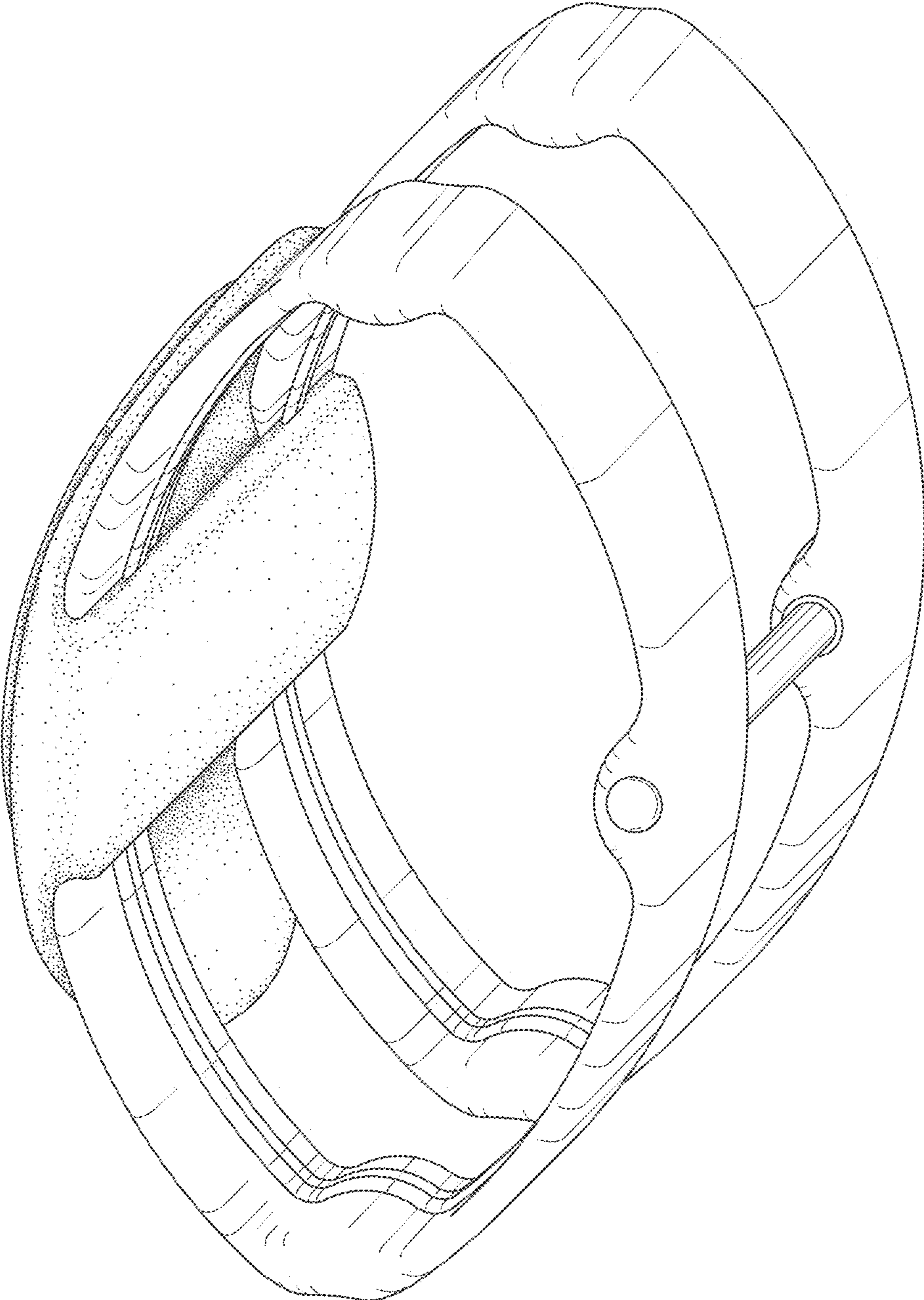

FIG. 2

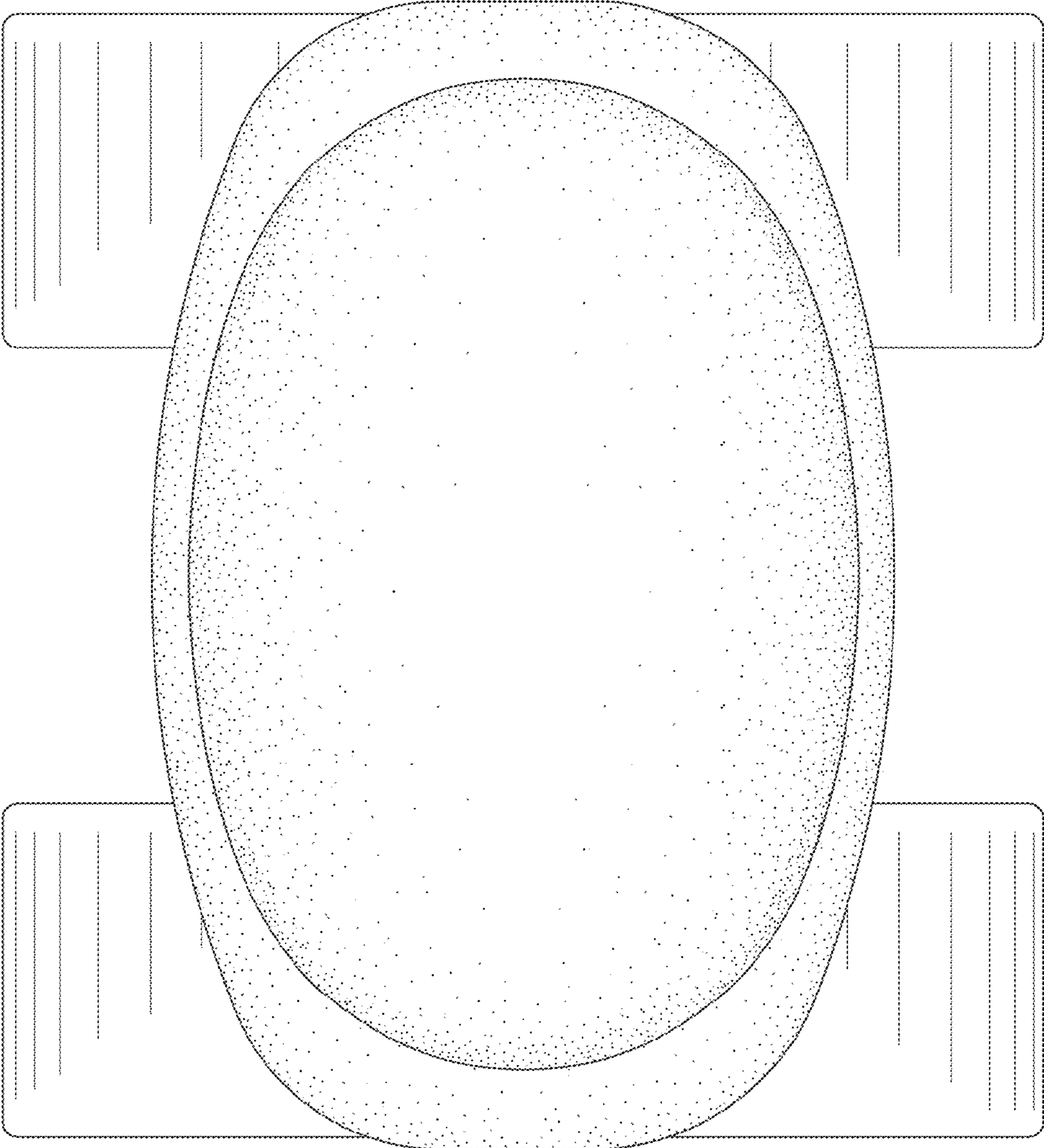

FIG. 3

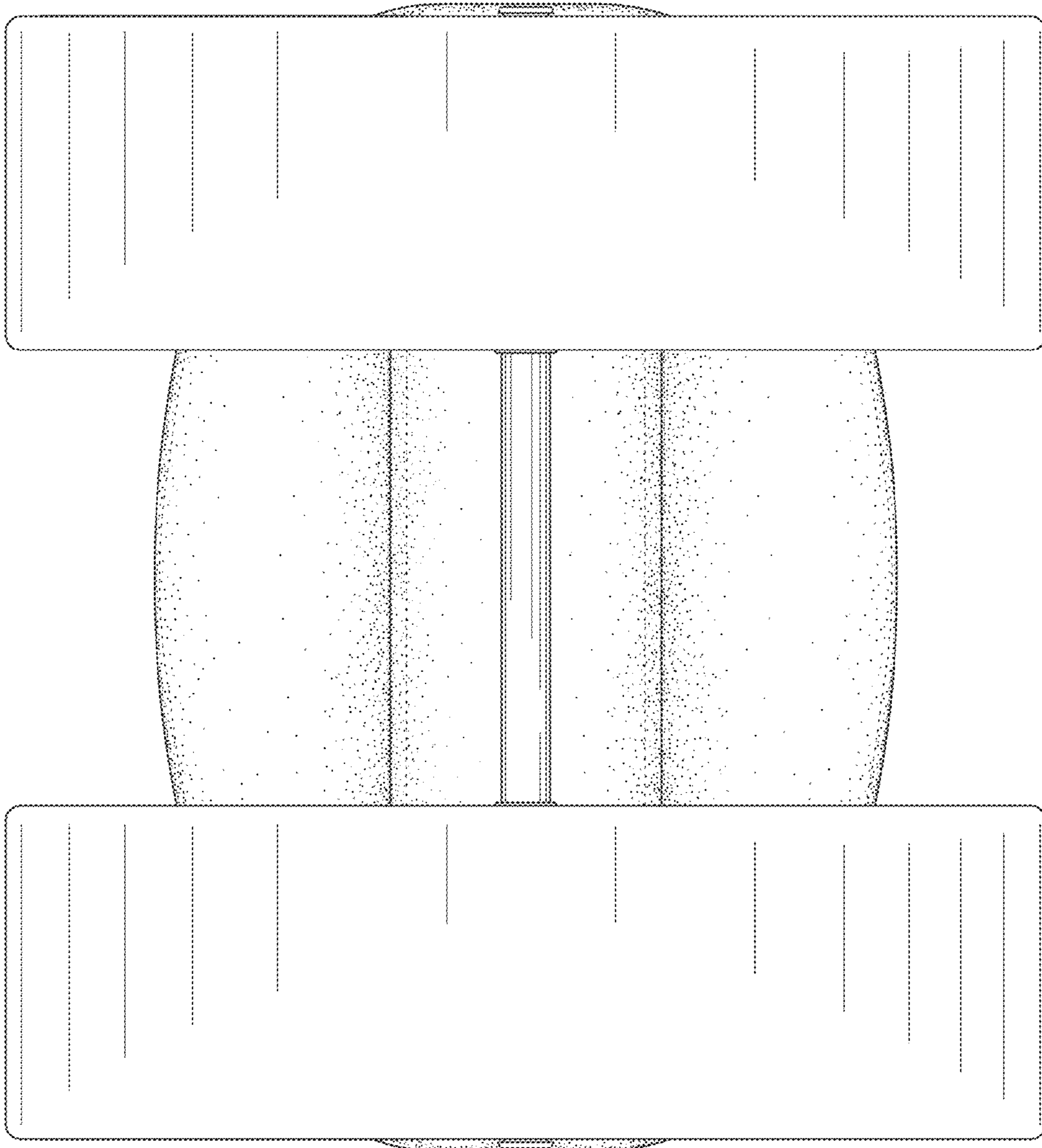

FIG. 4

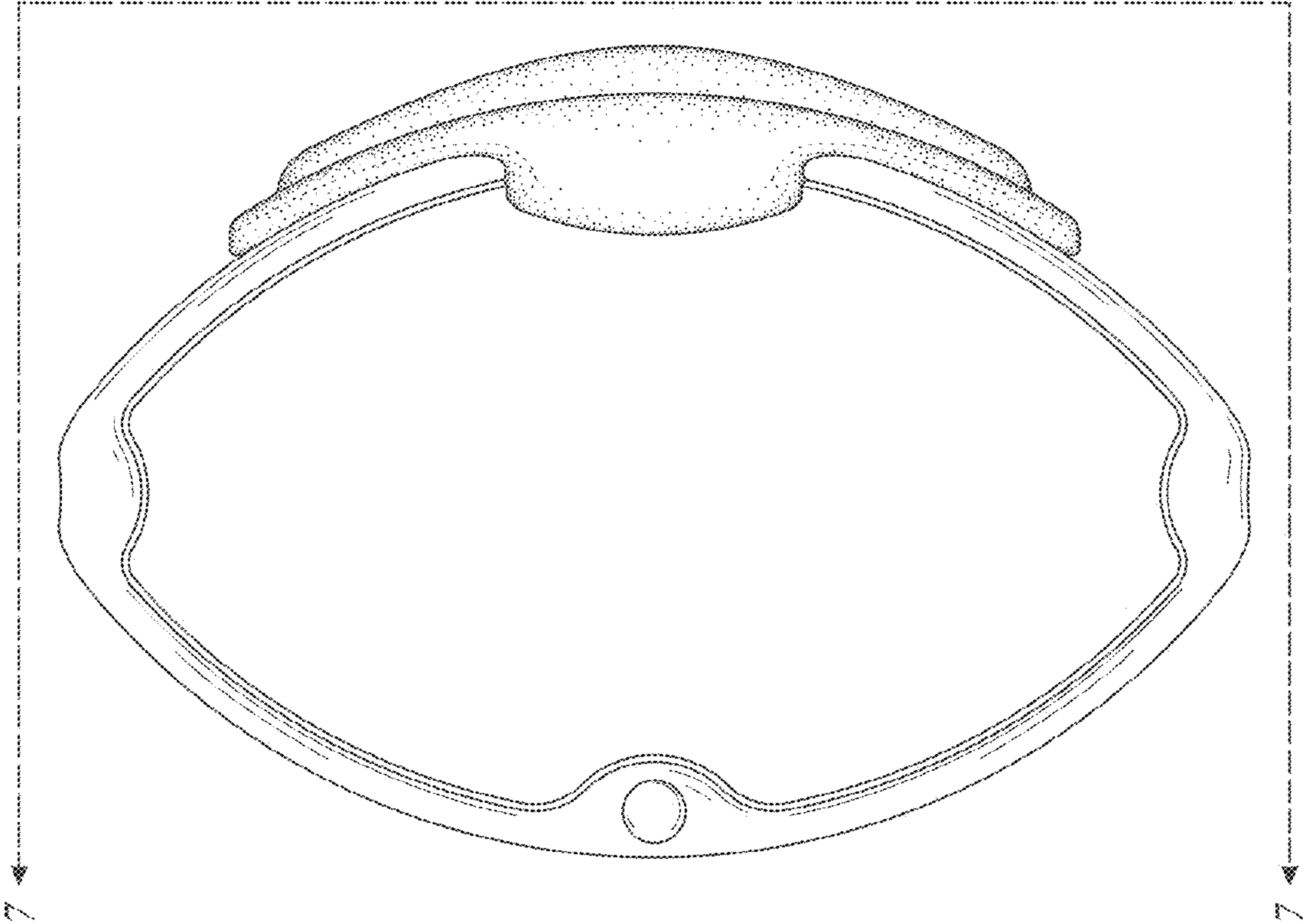

FIG. 5

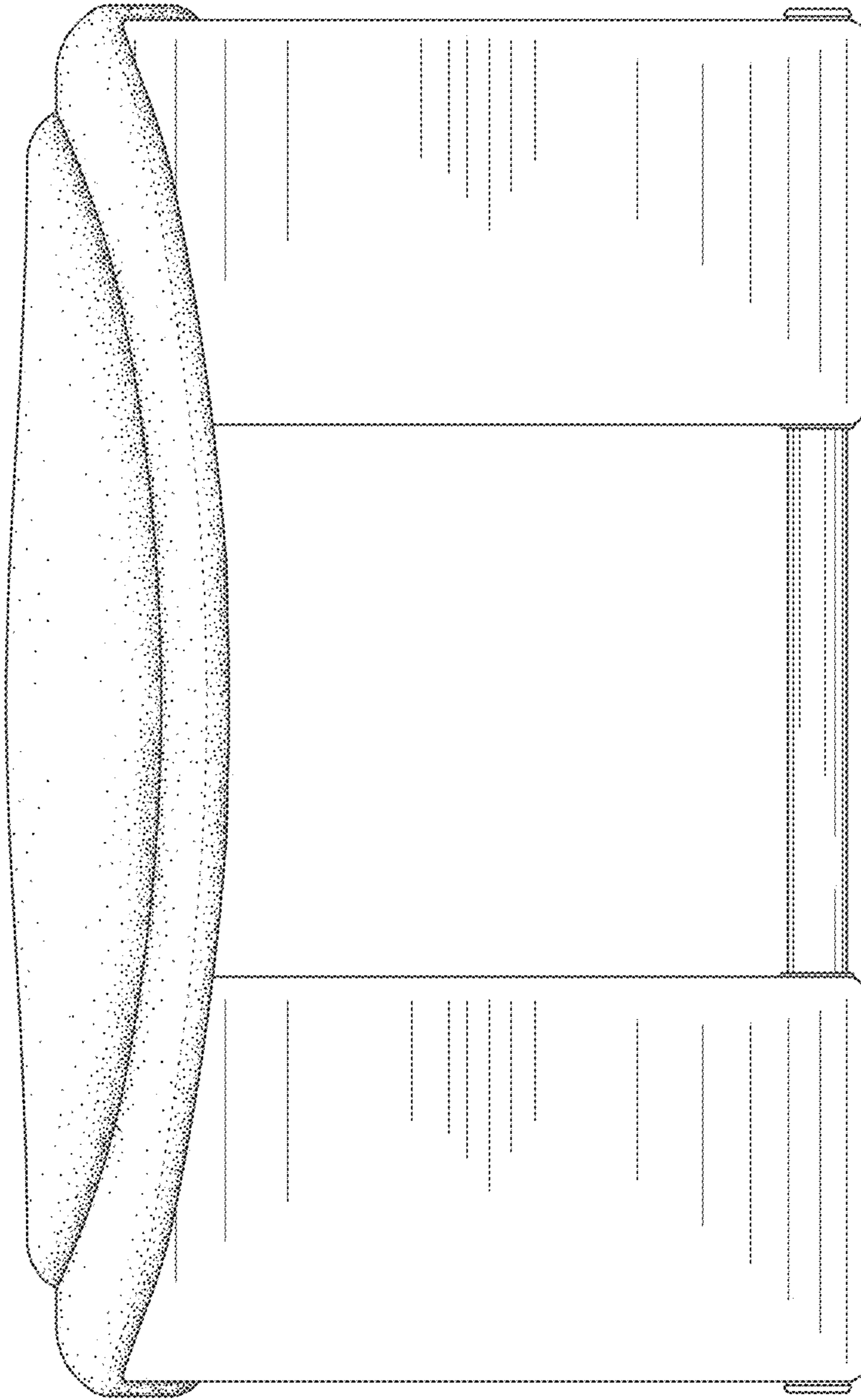

FIG. 6

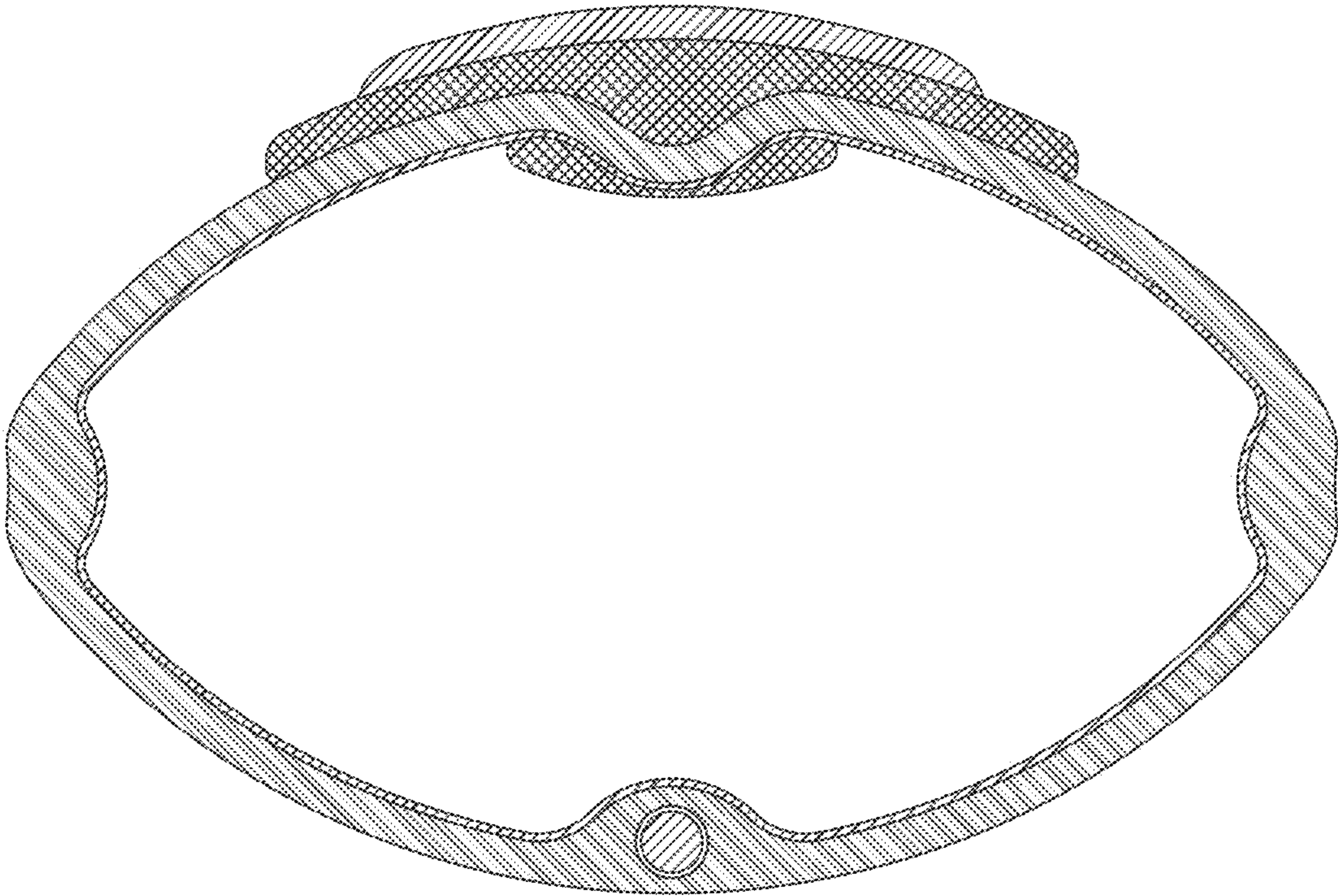

FIG. 7