



US00D917135S

(12) **United States Design Patent**  
**Hickenbotham**

(10) **Patent No.:** **US D917,135 S**

(45) **Date of Patent:** **\*\* Apr. 27, 2021**

(54) **BACKLESS CAP**

(71) Applicant: **Aleeshia Lynne Hickenbotham**, La Barge, WY (US)

(72) Inventor: **Aleeshia Lynne Hickenbotham**, La Barge, WY (US)

(\*\*) Term: **15 Years**

(21) Appl. No.: **29/660,121**

(22) Filed: **Aug. 17, 2018**

(51) **LOC (13) Cl.** ..... **02-03**

(52) **U.S. Cl.**  
USPC ..... **D2/876**; D2/882

(58) **Field of Classification Search**  
USPC ..... D2/865, 866, 875, 876, 877, 878, 879,  
D2/880, 881, 882, 883, 884, 885, 886,  
D2/887, 888, 891, 893  
CPC ..... A42B 1/00; A42B 1/002; A42B 1/004;  
A42B 1/006; A42B 1/02; A42B 1/061;  
A42B 1/062; A42B 1/063; A42B 1/201;  
A42B 1/225; A42C 5/04

See application file for complete search history.

(56) **References Cited**

**U.S. PATENT DOCUMENTS**

- 4,628,543 A \* 12/1986 Hunt ..... A63B 71/143  
2/161.1
- D352,379 S \* 11/1994 Pierce, Jr. .... D2/865
- D414,592 S \* 10/1999 McConnell ..... D2/865
- 7,024,702 B2 \* 4/2006 Kronenberger ..... A42B 1/06  
2/209.3
- D539,012 S \* 3/2007 Evans ..... D2/876
- D546,031 S \* 7/2007 Pearson ..... D2/875
- D669,252 S \* 10/2012 Rogers ..... D2/882
- D682,513 S \* 5/2013 House ..... D2/876
- D796,158 S \* 9/2017 Belle, Jr. .... D2/865

- 2004/0128740 A1 \* 7/2004 Hoyez ..... A42B 1/225  
2/209.7
- 2006/0117460 A1 \* 6/2006 Yan ..... A42B 1/062  
2/209.3
- 2013/0074246 A1 \* 3/2013 Rogers ..... A42B 1/225  
2/209.3

(Continued)

**OTHER PUBLICATIONS**

Satin Lined Baseball Cap . . . [online]; [review published to the Internet on Dec. 19, 2017]; [retrieved from the Internet on Jan. 5, 2020]; URL: [https://www.etsy.com/listing/563327616/satin-lined-baseball-cap-satin-bonnet?ref=shop\\_review](https://www.etsy.com/listing/563327616/satin-lined-baseball-cap-satin-bonnet?ref=shop_review). (4 pgs). (Year: 2017).\*

(Continued)

*Primary Examiner* — Jasmine Mlinarcik  
(74) *Attorney, Agent, or Firm* — Runyan Law; Charles Runyan

(57) **CLAIM**

The ornamental design for a backless cap, as shown and described.

**DESCRIPTION**

FIG. 1 is a front view of a backless cap design showing my new design;  
FIG. 2 is a front-left side perspective view thereof;  
FIG. 3 is a right view thereof;  
FIG. 4 is a left view thereof;  
FIG. 5 is a front-right perspective view thereof;  
FIG. 6 is a rear view thereof;  
FIG. 7 is a rear-left perspective view thereof;  
FIG. 8 is a rear-right perspective view thereof;  
FIG. 9 is a top view thereof;  
FIG. 10 is a rear-left bottom perspective view thereof;  
FIG. 11 is a rear-right bottom perspective view thereof;  
FIG. 12 is a bottom perspective view thereof;  
FIG. 13 is a rear-right bottom perspective view thereof; and,  
FIG. 14 is a rear-left bottom perspective view thereof.

**1 Claim, 14 Drawing Sheets**

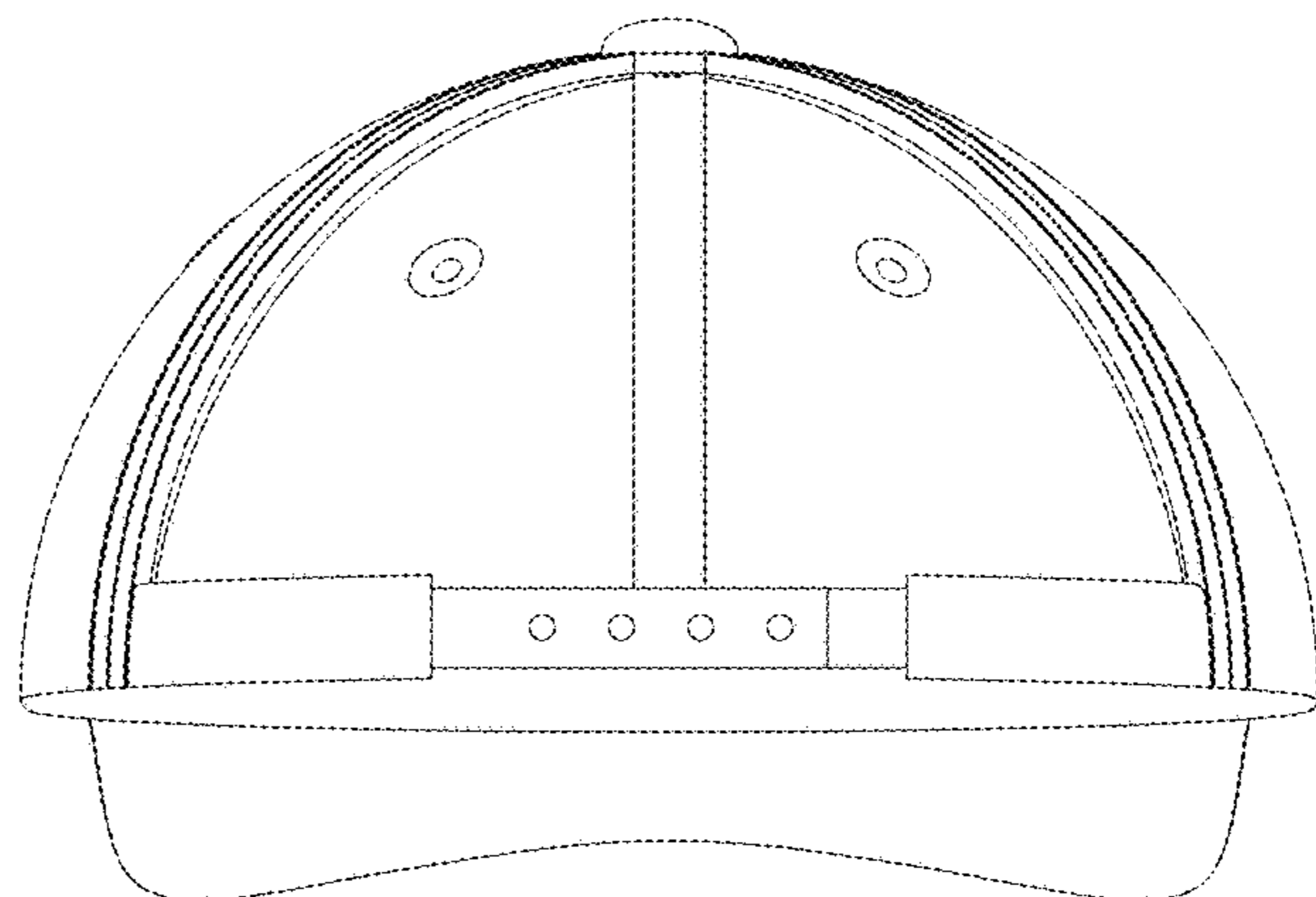
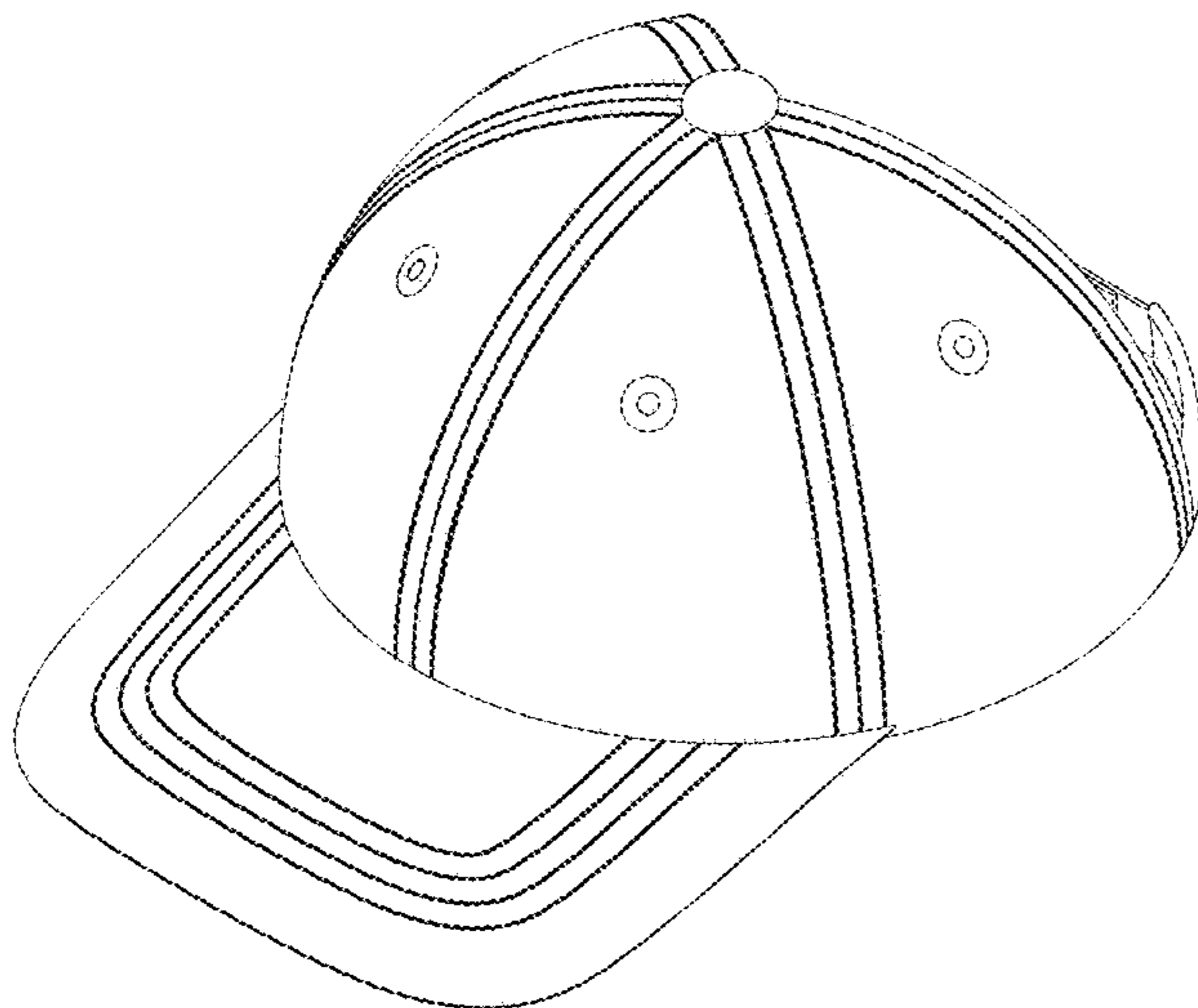

(56)

**References Cited**

U.S. PATENT DOCUMENTS

2014/0130235 A1\* 5/2014 Johnson ..... A42B 1/225  
2/209.3

OTHER PUBLICATIONS

No Luck Fining Ivy Park Cap, [online]; [video published to the Internet on Jan. 28, 2018]; [retrieved from the Internet on Mar. 22, 2020]; URL: <https://www.youtube.com/watch?v=S14txj8UNpo>. (1 page). (Year: 2018).\*

\* cited by examiner

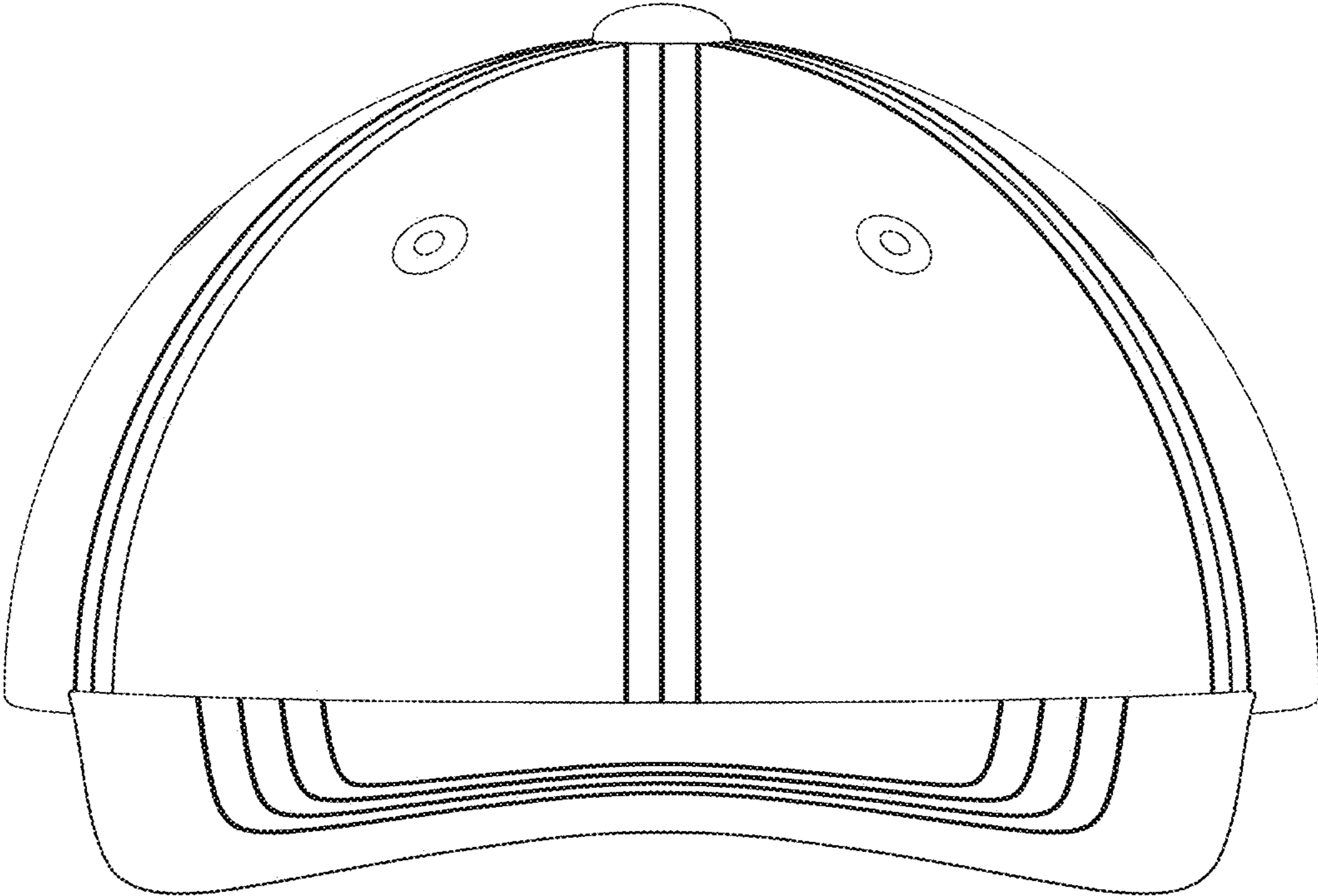

FIG. 1

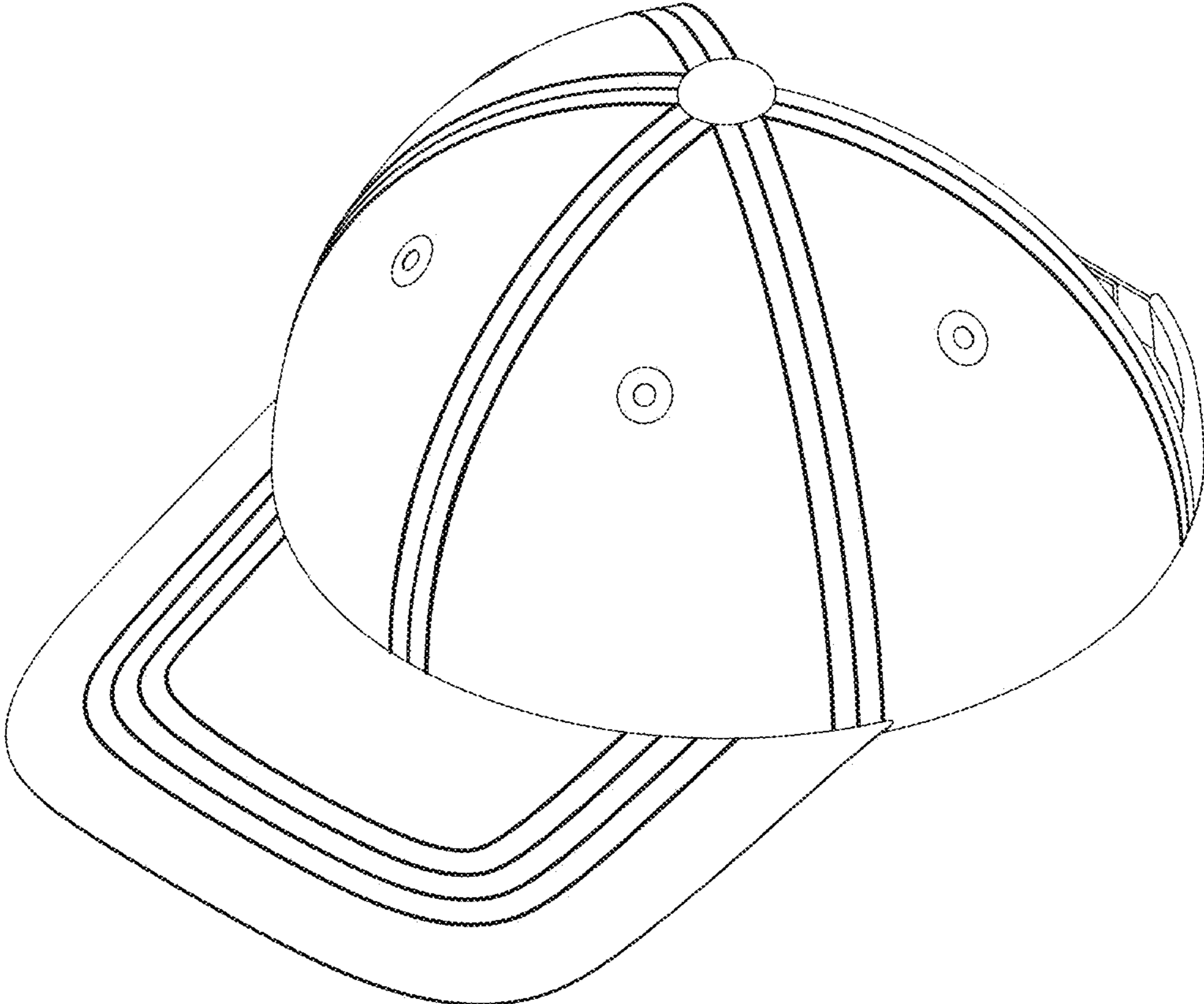

FIG. 2

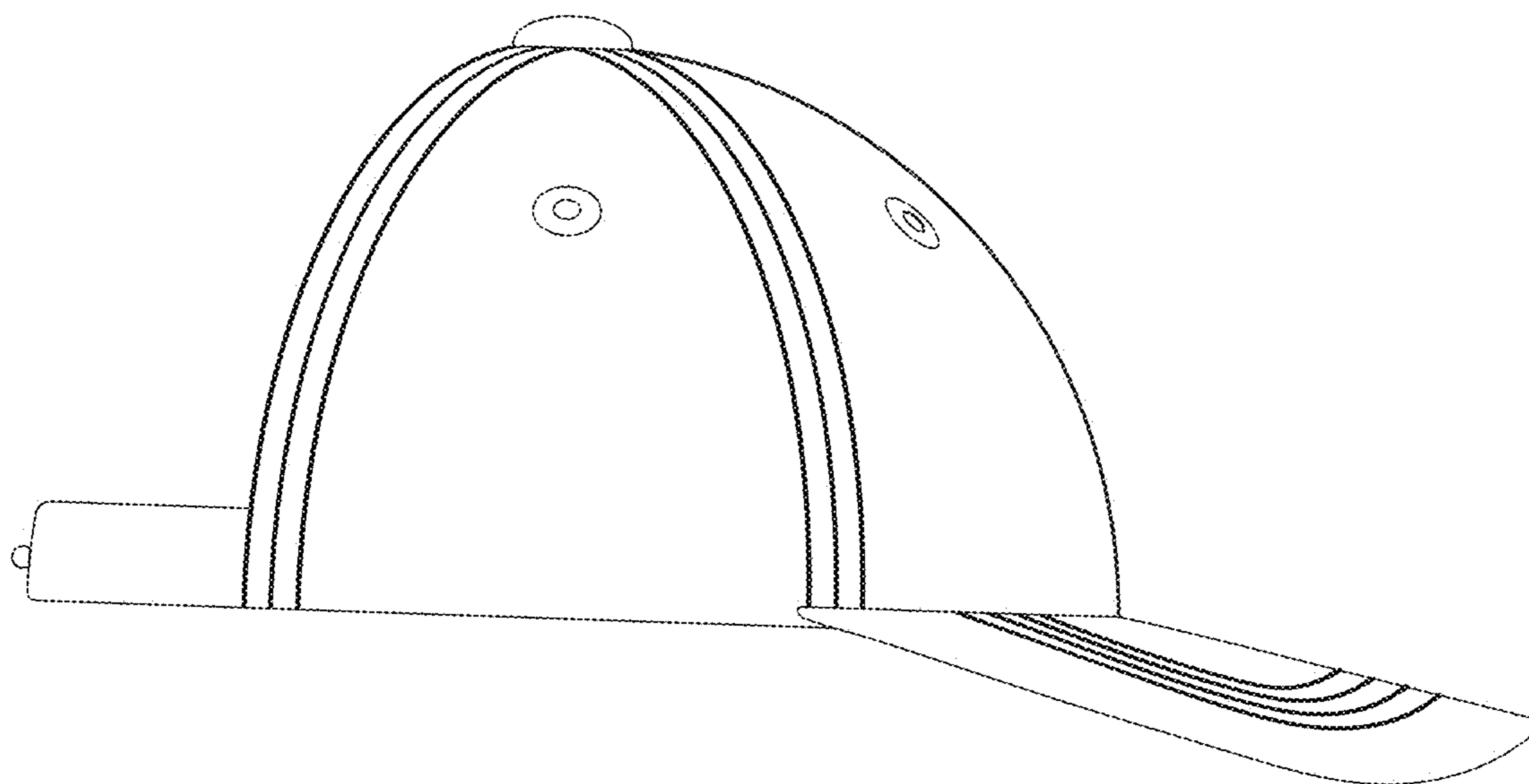

FIG. 3

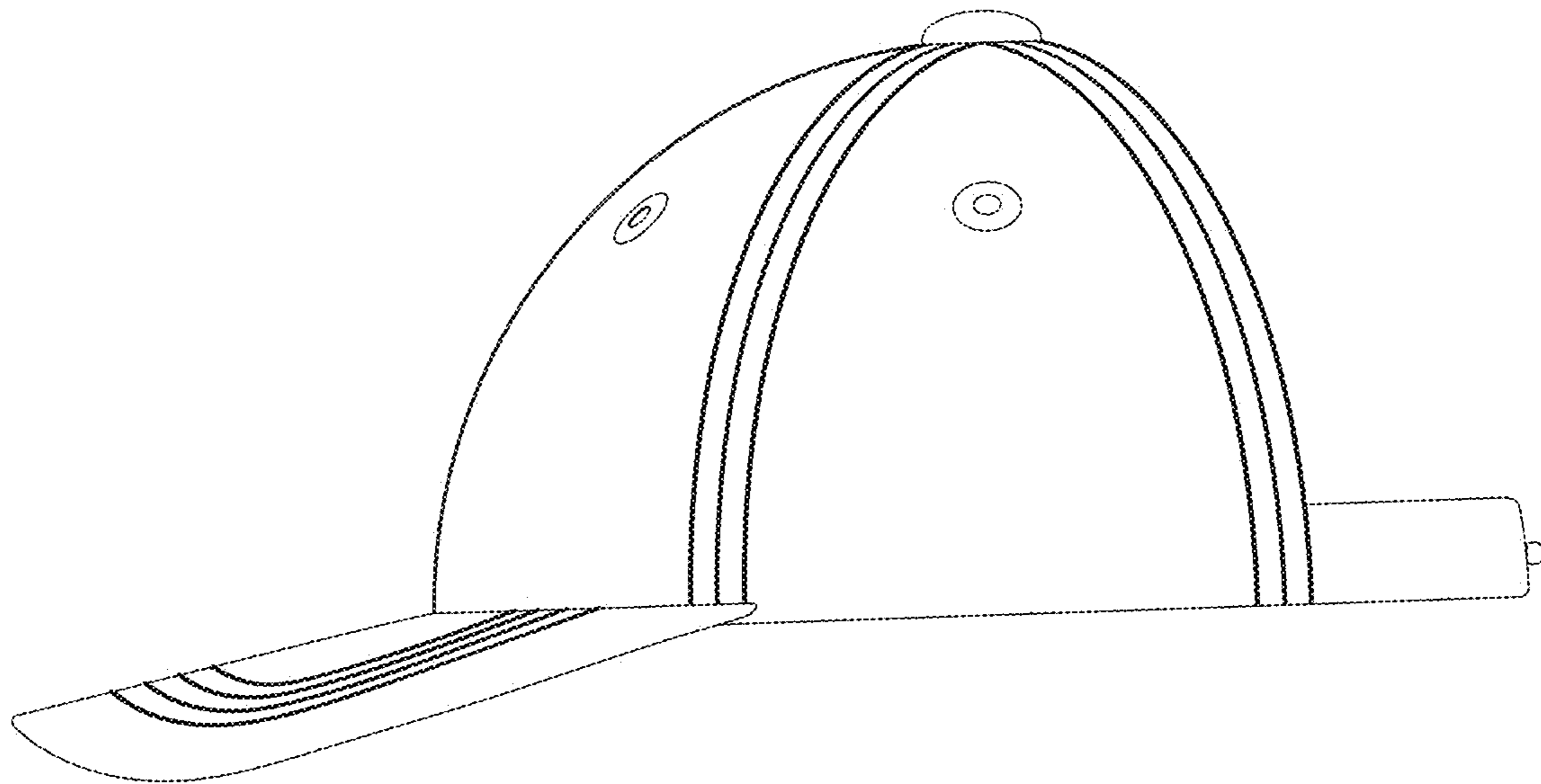

FIG. 4



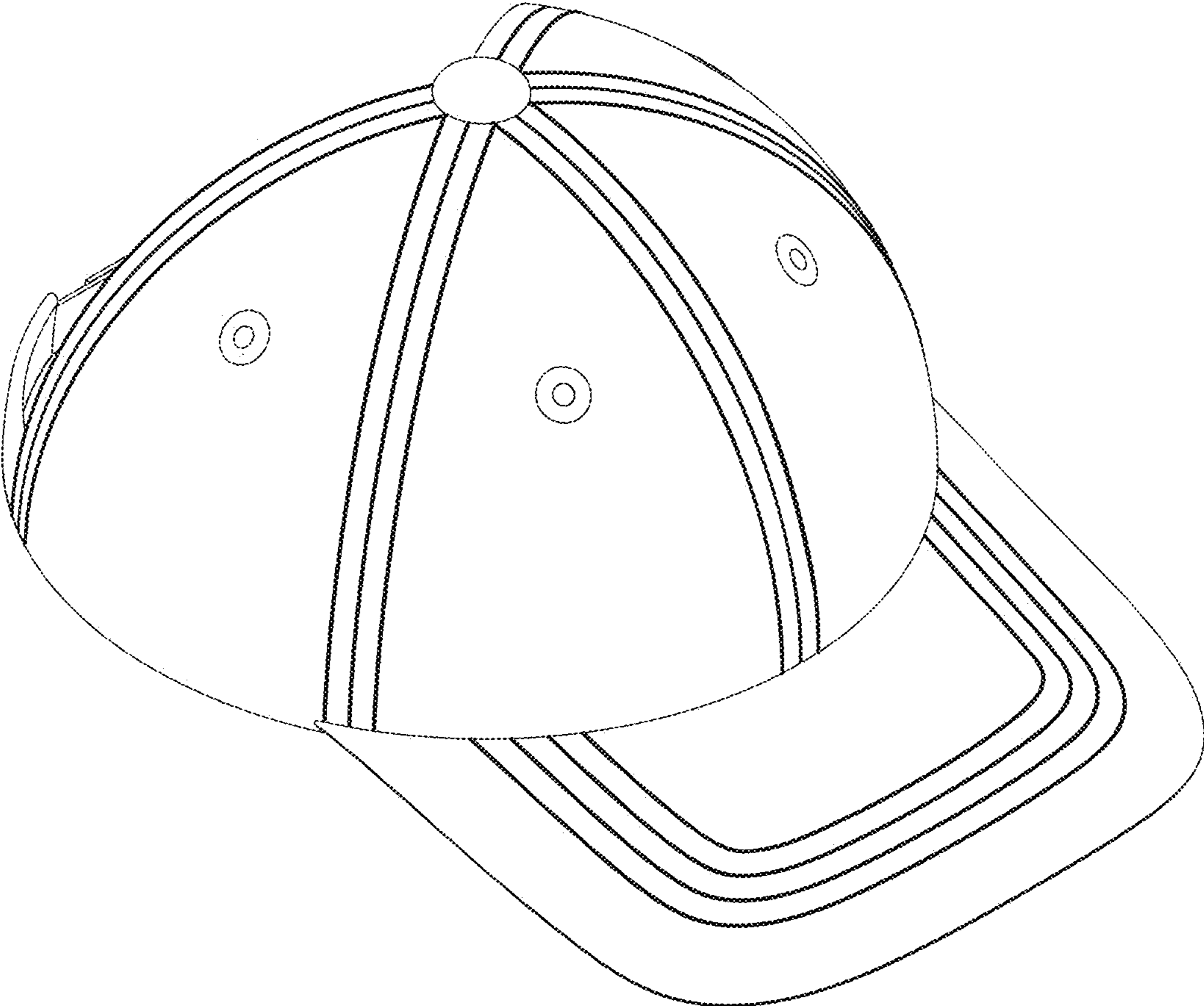

FIG. 5

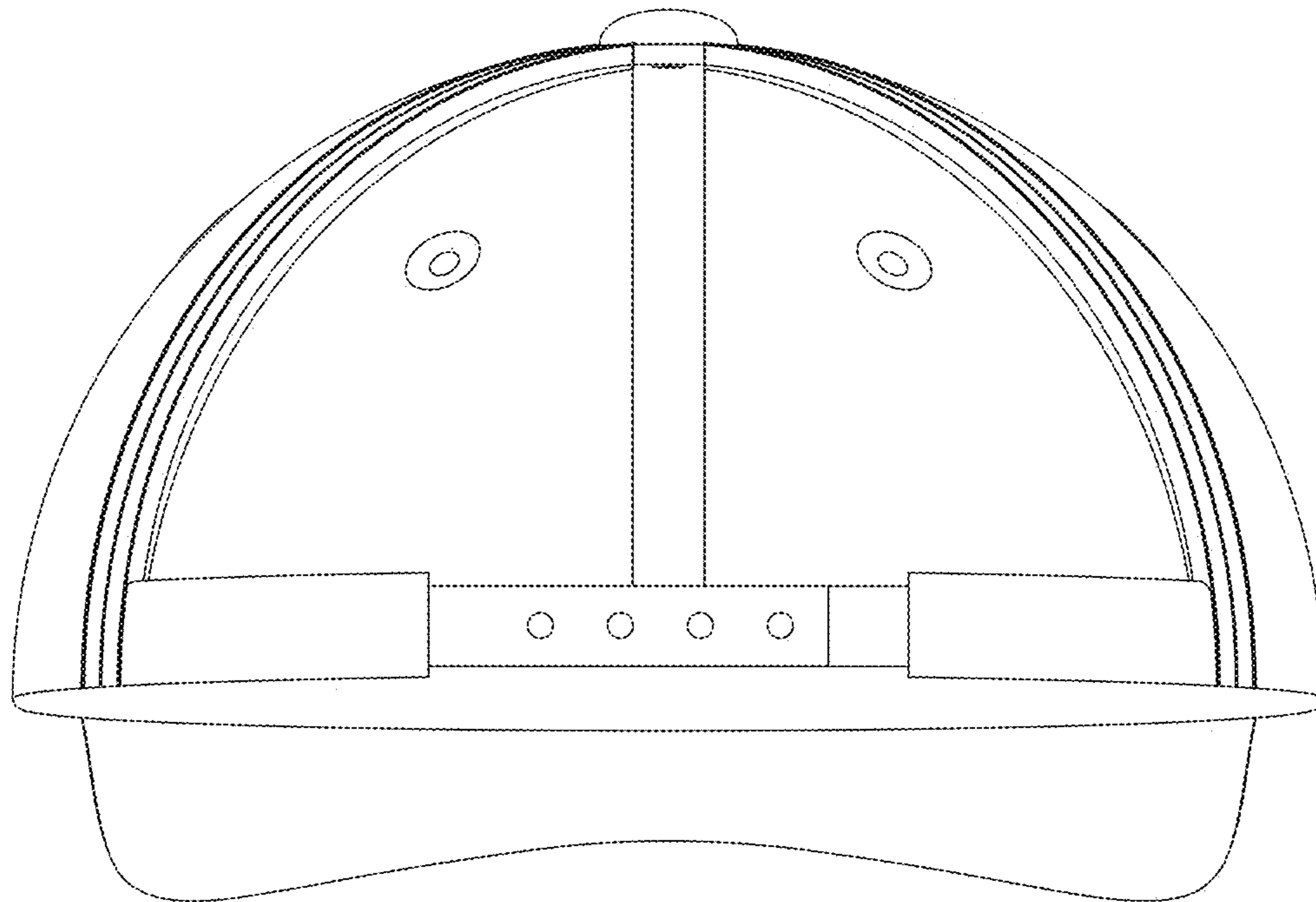

FIG. 6



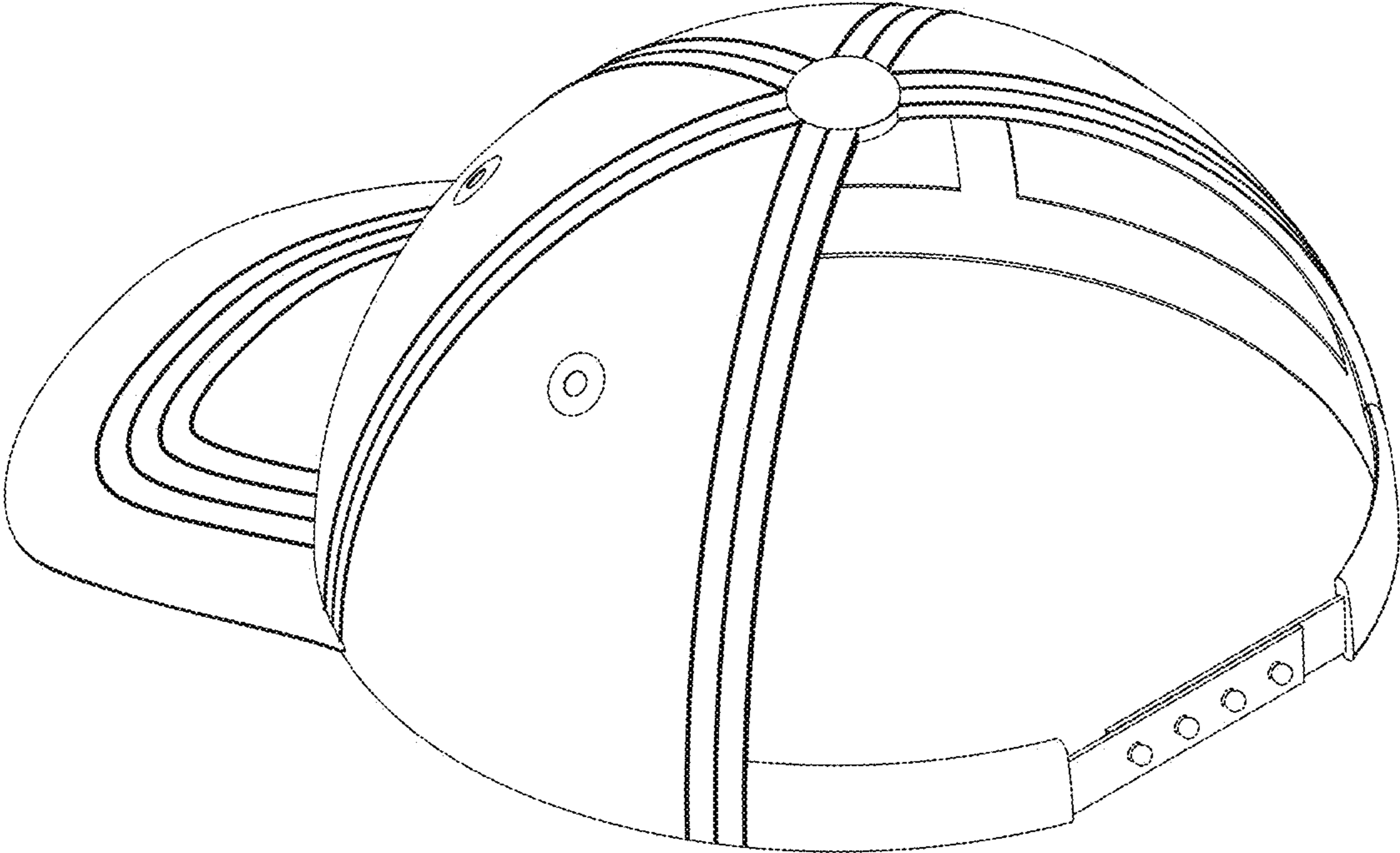

FIG. 7

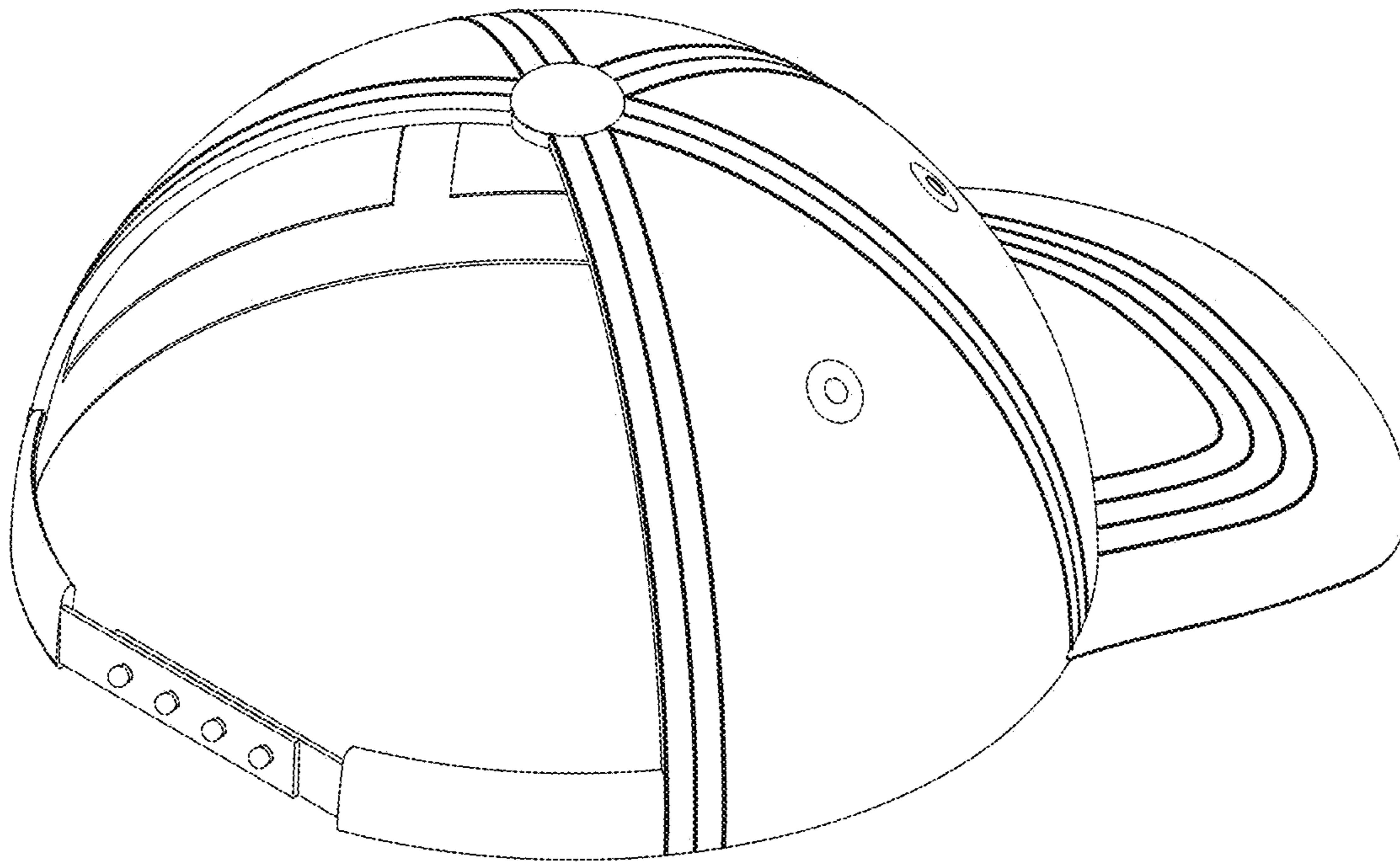

FIG. 8

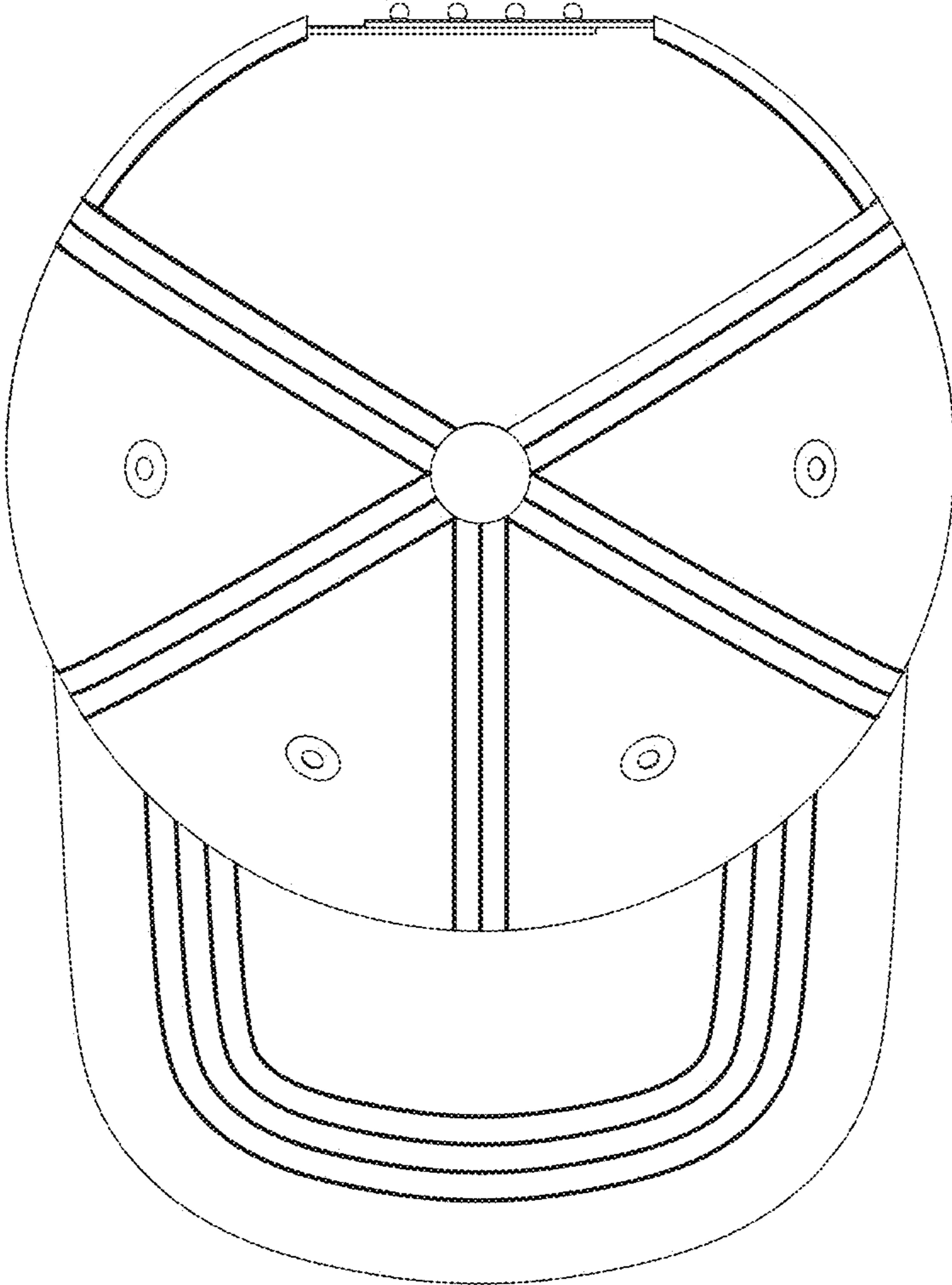

FIG. 9

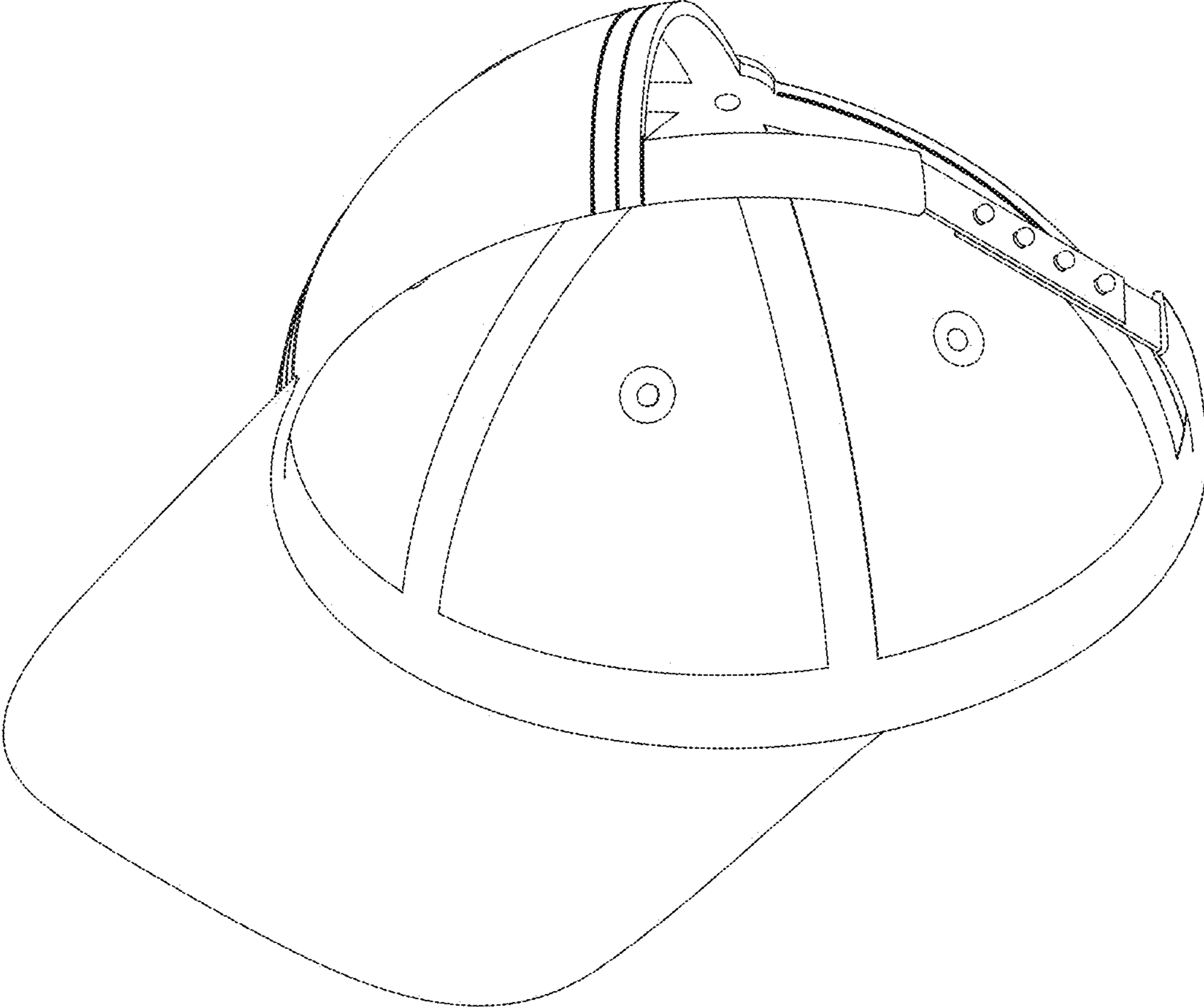

FIG. 10

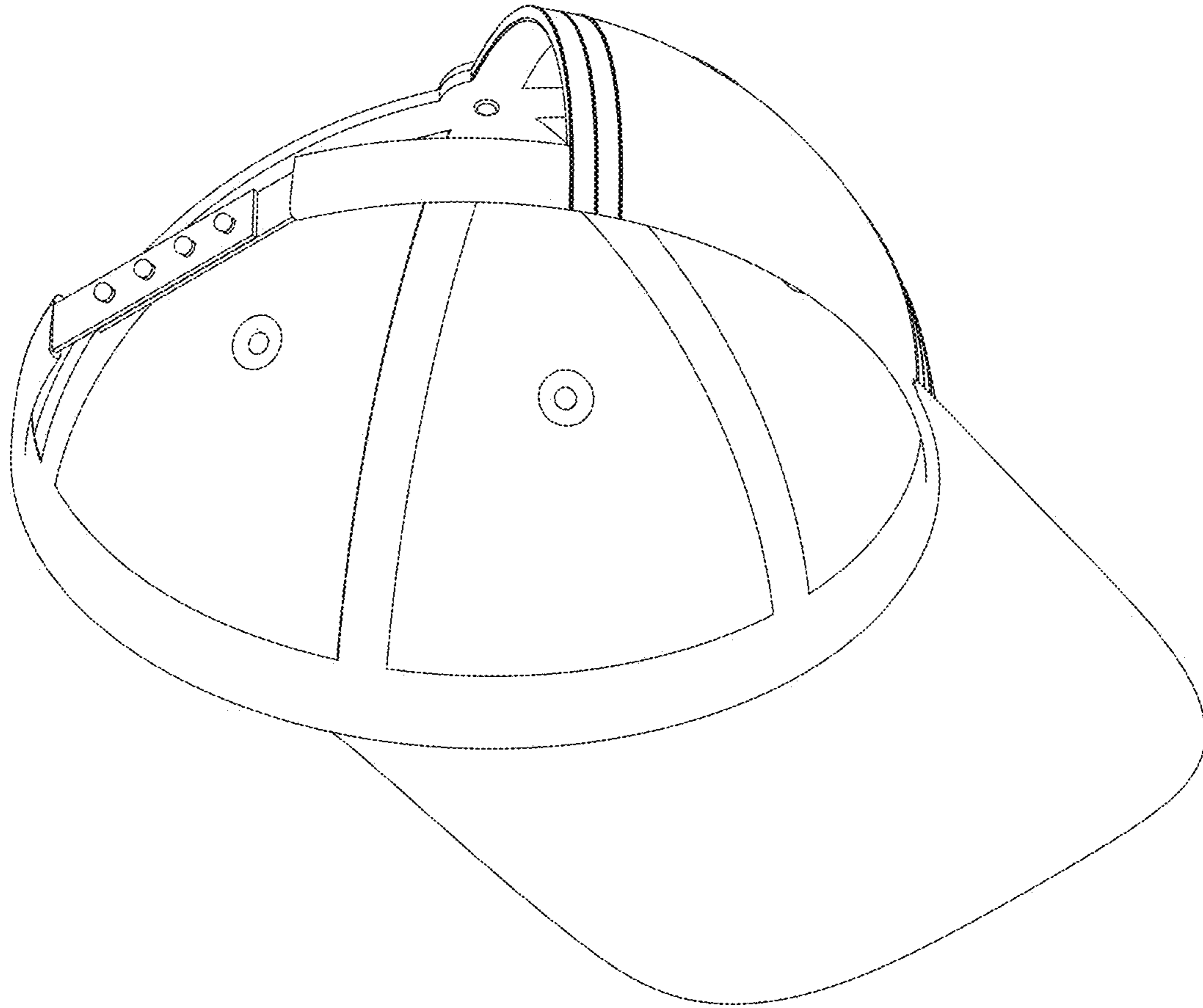

FIG. 11

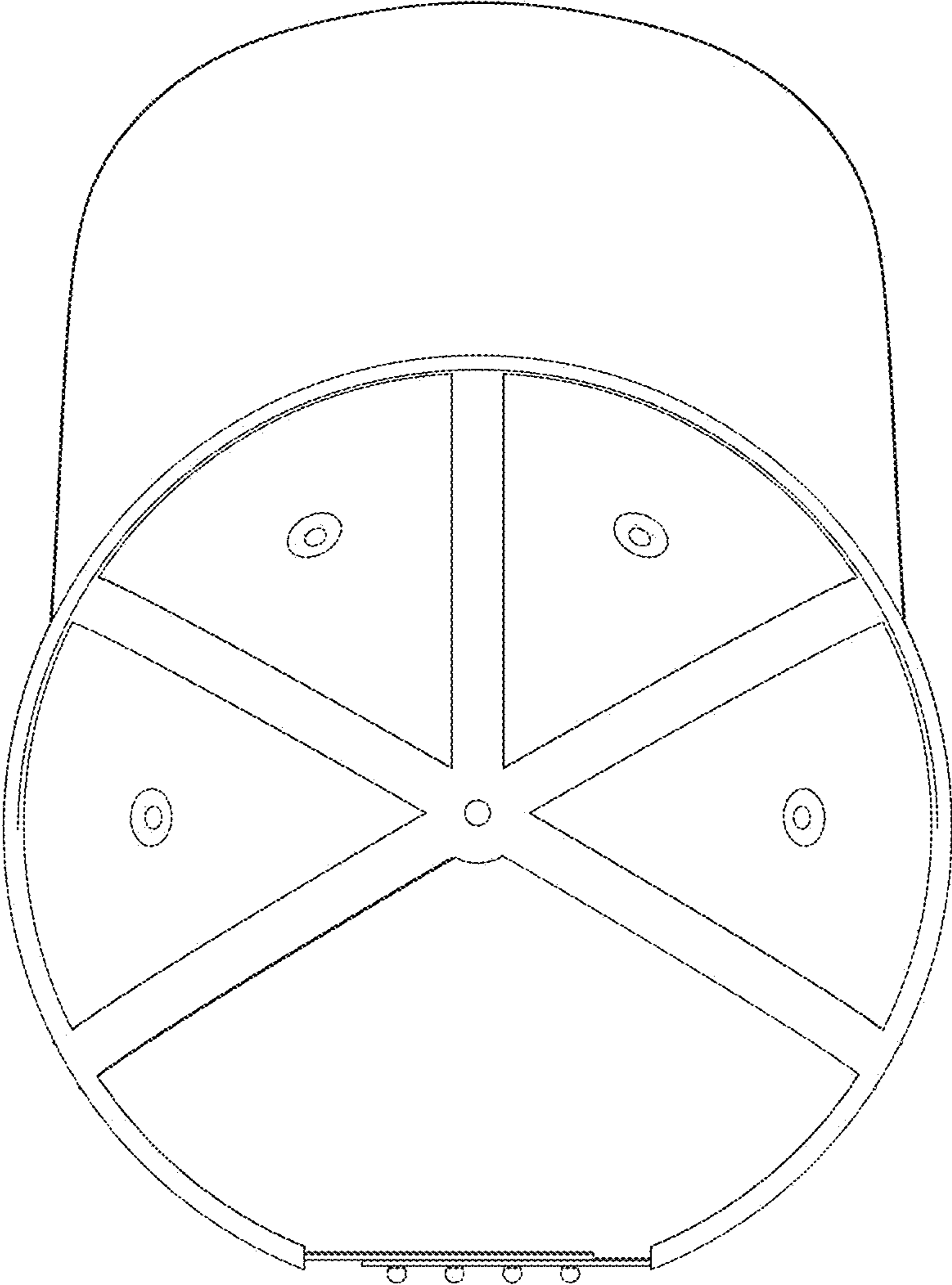

FIG. 12



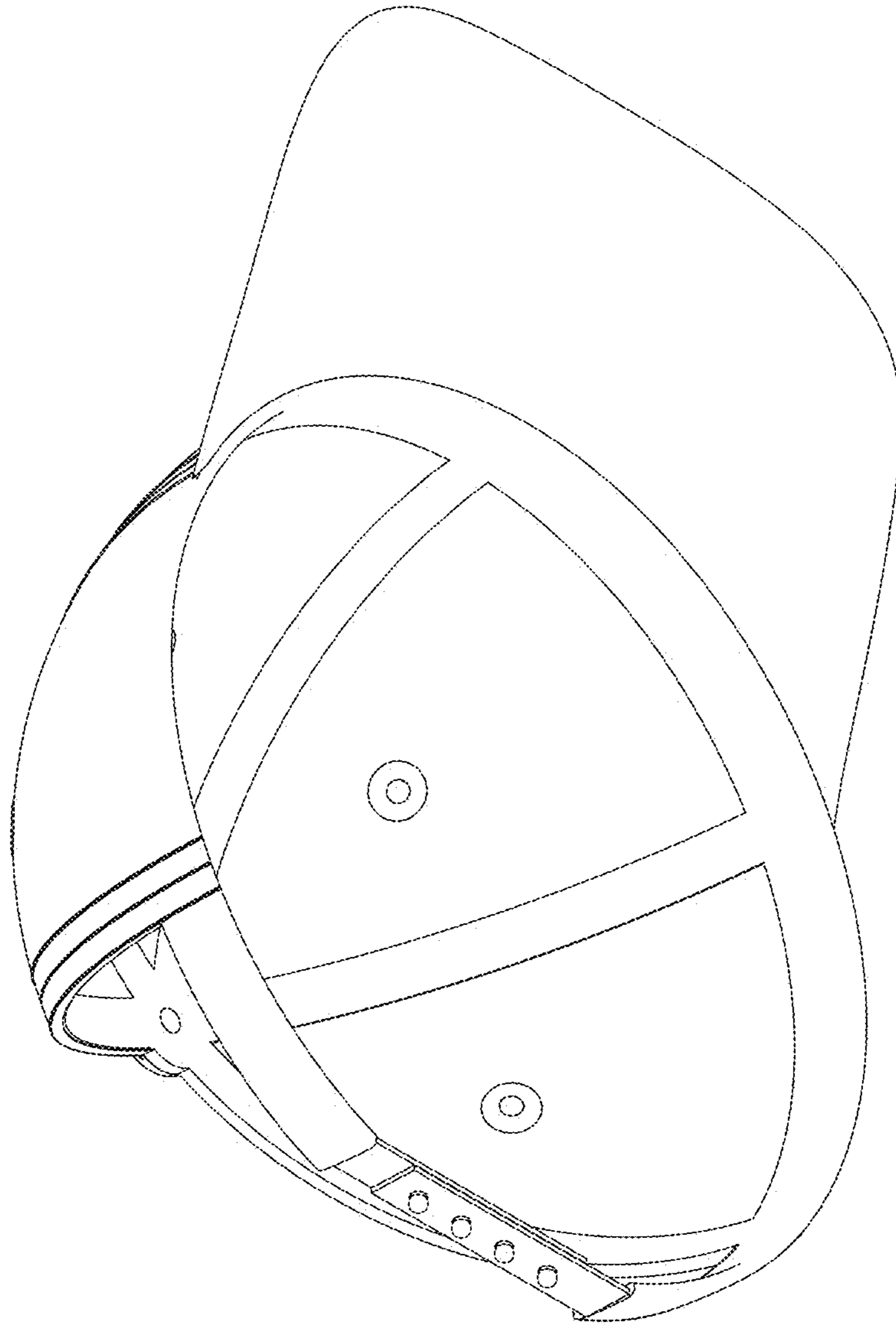

FIG. 13

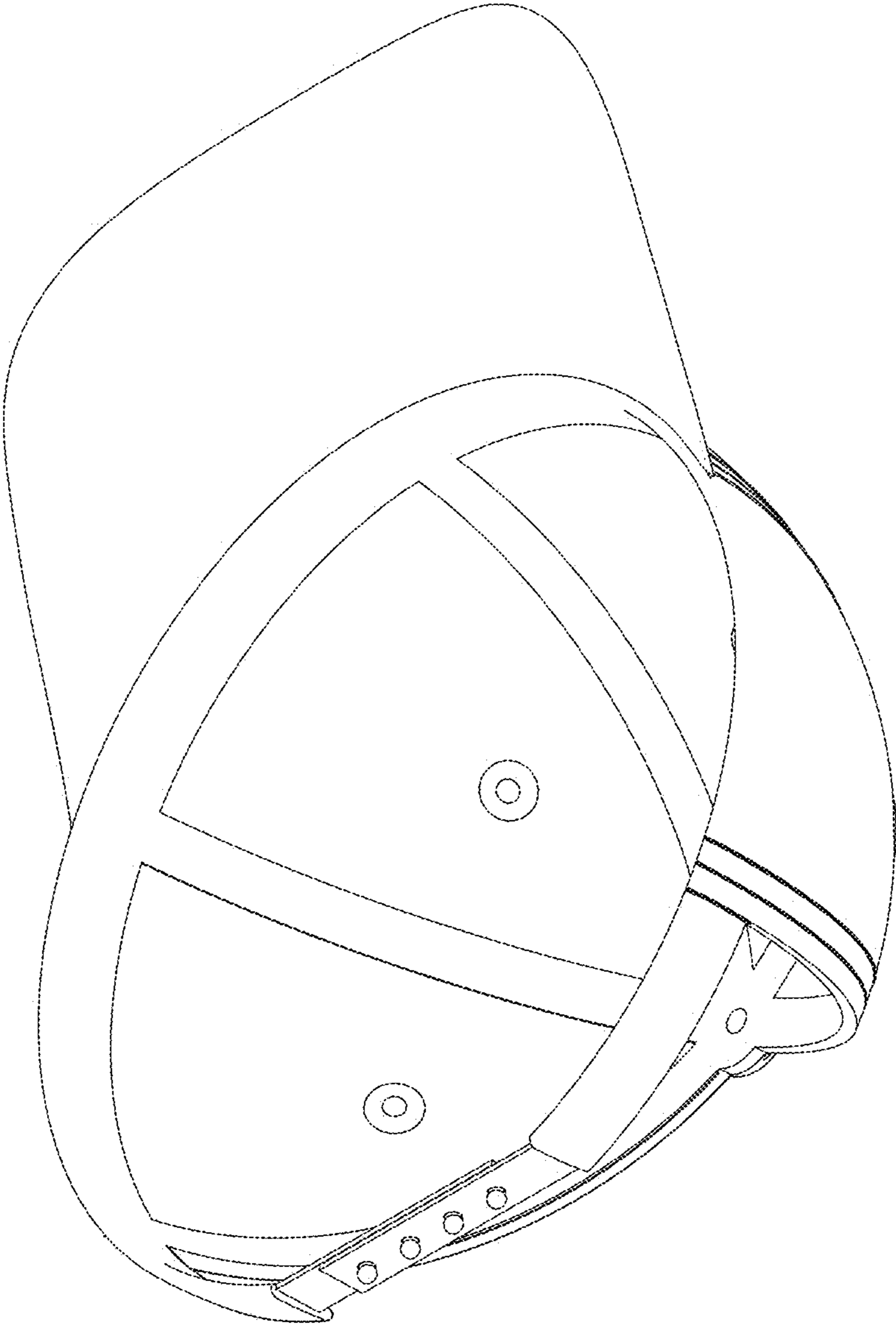

FIG. 14