



US00D917064S

(12) **United States Design Patent** (10) **Patent No.:** **US D917,064 S**
Ribeiro et al. (45) **Date of Patent:** **** Apr. 20, 2021**

(54) **OSTOMY CLEANING TOOL**
(71) Applicants: **Christian Ribeiro**, River Edge, NJ (US); **Ali Eldin**, Glendale, CA (US)
(72) Inventors: **Christian Ribeiro**, River Edge, NJ (US); **Ali Eldin**, Glendale, CA (US)
(**) Term: **15 Years**
(21) Appl. No.: **29/687,955**
(22) Filed: **Apr. 17, 2019**
(51) **LOC (13) Cl.** **24-02**
(52) **U.S. Cl.**
USPC **D24/217**
(58) **Field of Classification Search**
USPC D24/107, 108, 110, 110.4–110.6, D24/111–115, 117–122, 123, 130, 133, D24/141, 152, 186, 215, 116, 216–219, D24/231, 232, 164, 128, 109, 127, 129, D24/189, 131; D9/436, 439, 440, 447, D9/723, 718, 719, 724, 521, 529, 549, D9/558, 574, 575, 686–694; D28/7, 8, D28/85; D3/201, 203.1–203.4, 232, 243, D3/244, 300
CPC A61M 25/065; A61M 25/0612; A61M 25/00; A61M 25/0043; A61M 25/0067; A61M 25/0097; A61M 39/00; A61M 27/00; A61M 5/42; A61F 2/958
See application file for complete search history.

(56) **References Cited**
U.S. PATENT DOCUMENTS
2,928,393 A * 3/1960 Marsan A61F 5/445 604/334
4,642,106 A * 2/1987 Downey A61F 5/44 600/573
D302,605 S * 8/1989 Gebhart D28/87
D313,289 S * 12/1990 Bakic D28/88
D434,560 S * 12/2000 Chao D3/265

D452,529 S * 12/2001 Tsuchida D19/163
D457,062 S * 5/2002 Lloyd D9/504
D467,391 S * 12/2002 Orsomando D28/76
D468,060 S * 12/2002 Orsomando D28/76
D483,155 S * 12/2003 Orsomando D28/89
D507,973 S * 8/2005 Bigliarians D9/504
D519,740 S * 5/2006 Green D3/206
D522,320 S * 6/2006 Schmidt D7/608
D524,488 S * 7/2006 Bouix D28/76
D538,479 S * 3/2007 Martinez D28/88
D550,283 S * 9/2007 Koreska D19/66
D558,345 S * 12/2007 Witt D24/152
D565,953 S * 4/2008 Swint D9/504
D566,762 S * 4/2008 Qiu D19/163
D570,545 S * 6/2008 Althoff D28/76
D571,044 S * 6/2008 Conte D28/65
D605,364 S * 12/2009 Lokken D28/85

(Continued)

Primary Examiner — T Chase Nelson
Assistant Examiner — Kelly L Gross
(74) *Attorney, Agent, or Firm* — Scott H. Kaliko, Esq;
Kaliko & Associates, LLC

(57) **CLAIM**
The ornamental design for an ostomy cleaning tool, as shown and described.

DESCRIPTION
FIG. 1 is a perspective view of an ostomy cleaning tool showing my new design;
FIG. 2 is a front view thereof;
FIG. 3 is a back view thereof;
FIG. 4 is a side view thereof;
FIG. 5 is an opposite side view thereof;
FIG. 6 is a top view thereof;
FIG. 7 is a bottom view thereof; and,
FIG. 8 is a perspective view thereof, showing the design in an exploded state.
In FIG. 8, the evenly spaced broken lines represent the portions of the design that form no part of the claim.

1 Claim, 5 Drawing Sheets

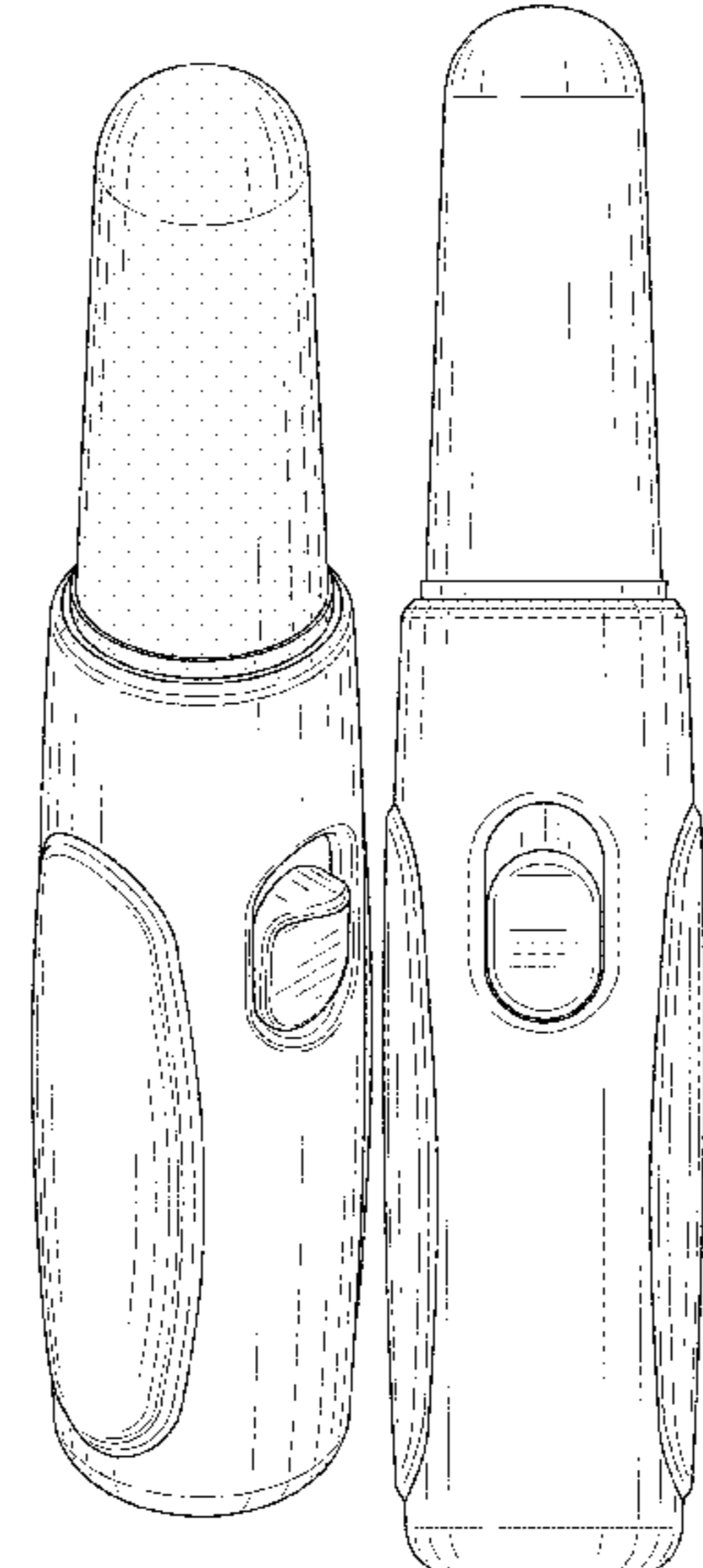

(56)

References Cited

U.S. PATENT DOCUMENTS

| | | | | | | | |
|----------------|---------|----------------|------------------------|-----------------|---------|------------|--------------|
| D617,904 S * | 6/2010 | Lai | D24/146 | D857,988 S * | 8/2019 | Huchet | D28/7 |
| D630,524 S * | 1/2011 | van Dullemen | D9/725 | D862,690 S * | 10/2019 | Jansen | D24/113 |
| D633,384 S * | 3/2011 | Tanaka | D9/447 | D863,549 S * | 10/2019 | Jansen | D24/113 |
| D639,998 S * | 6/2011 | Liu | D28/7 | D865,965 S * | 11/2019 | Siciliano | D24/146 |
| D644,322 S * | 8/2011 | Py | D24/112 | D881,716 S * | 4/2020 | Tempfli | D9/724 |
| D654,217 S * | 2/2012 | Brodish | D28/7 | D882,412 S * | 4/2020 | Tempfli | D9/724 |
| D655,621 S * | 3/2012 | Py | D9/724 | D886,375 S * | 6/2020 | Zhou | D28/36 |
| D666,733 S * | 9/2012 | Caggiano | D24/215 | D886,387 S * | 6/2020 | Choi | D28/88 |
| D669,124 S * | 10/2012 | Jiang | D19/163 | D886,610 S * | 6/2020 | Aboabdo | D9/503 |
| D683,016 S * | 5/2013 | Mirza | D24/112 | D886,633 S * | 6/2020 | Han | D9/724 |
| 8,443,480 B2 * | 5/2013 | Zaytoun, Jr. | A61F 5/445 15/210.1 | D886,989 S * | 6/2020 | Lucio | D24/127 |
| D690,383 S * | 9/2013 | Sheikh | D22/117 | D889,278 S * | 7/2020 | Tempfli | D9/724 |
| D693,053 S * | 11/2013 | Chen | D27/101 | D890,948 S * | 7/2020 | Figueredo | D24/224 |
| D696,413 S * | 12/2013 | Tai | D24/215 | D892,624 S * | 8/2020 | Son | D9/504 |
| D696,775 S * | 12/2013 | Guarraia | D24/113 | D892,628 S * | 8/2020 | Caruso | D9/688 |
| 8,596,897 B2 * | 12/2013 | Cole | A45D 40/00 401/195 | D894,004 S * | 8/2020 | Aboabdo | D9/503 |
| D699,287 S * | 2/2014 | Lv | D19/163 | D895,106 S * | 9/2020 | Patil | D24/113 |
| D710,992 S * | 8/2014 | Dubuc | D24/113 | D895,807 S * | 9/2020 | Berkely | D24/176 |
| D747,543 S * | 1/2016 | Taha | D27/165 | D895,828 S * | 9/2020 | Marshall | D24/215 |
| D749,957 S * | 2/2016 | Ishida | D9/529 | D901,802 S * | 11/2020 | Taub | D32/40 |
| D756,124 S * | 5/2016 | Nguyen | D4/108 | D902,738 S * | 11/2020 | Alfaras | D9/688 |
| D758,668 S * | 6/2016 | Bonnin | D28/89 | D903,106 S * | 11/2020 | Draper | D24/113 |
| D760,087 S * | 6/2016 | Dittmer | D9/556 | D903,107 S * | 11/2020 | Draper | D24/113 |
| D767,759 S * | 9/2016 | McMillon-Nixon | D24/141 | D904,006 S * | 12/2020 | Chowdhury | D3/202 |
| D786,423 S * | 5/2017 | Jones | D24/113 | D904,902 S * | 12/2020 | Yang | D9/724 |
| D797,286 S * | 9/2017 | Ginggen | D24/146 | D905,850 S * | 12/2020 | Ganter | D24/115 |
| D802,750 S * | 11/2017 | Jones | D24/113 | D906,117 S * | 12/2020 | Shiota | D9/504 |
| D829,890 S * | 10/2018 | Denzer | A45D 40/00 D24/113 | D906,132 S * | 12/2020 | Fuketa | D9/724 |
| D830,143 S * | 10/2018 | Knirr | D8/42 | D906,520 S * | 12/2020 | Wang | D24/146 |
| D838,048 S * | 1/2019 | Jeong | D28/76 | D907,502 S * | 1/2021 | Kilduff | D9/504 |
| D840,837 S * | 2/2019 | Woods | D9/711 | D907,766 S * | 1/2021 | Lehmann | D24/114 |
| D841,234 S * | 2/2019 | Laaly | D28/7 | D907,852 S * | 1/2021 | Lombardo | D28/50 |
| D844,893 S * | 4/2019 | Huchet | D28/7 | D909,204 S * | 2/2021 | Tempfli | D9/448 |
| D850,845 S * | 6/2019 | Pan | D7/378 | D910,837 S * | 2/2021 | Ono | D24/112 |
| | | | | D910,846 S * | 2/2021 | Siciliano | D24/144 |
| | | | | D910,849 S * | 2/2021 | Shi | D24/146 |
| | | | | D910,904 S * | 2/2021 | Liu | D27/162 |
| | | | | D911,610 S * | 2/2021 | Zhang | D28/50 |
| | | | | 10,918,792 B2 * | 2/2021 | McLoughlin | A61M 5/31576 |

* cited by examiner

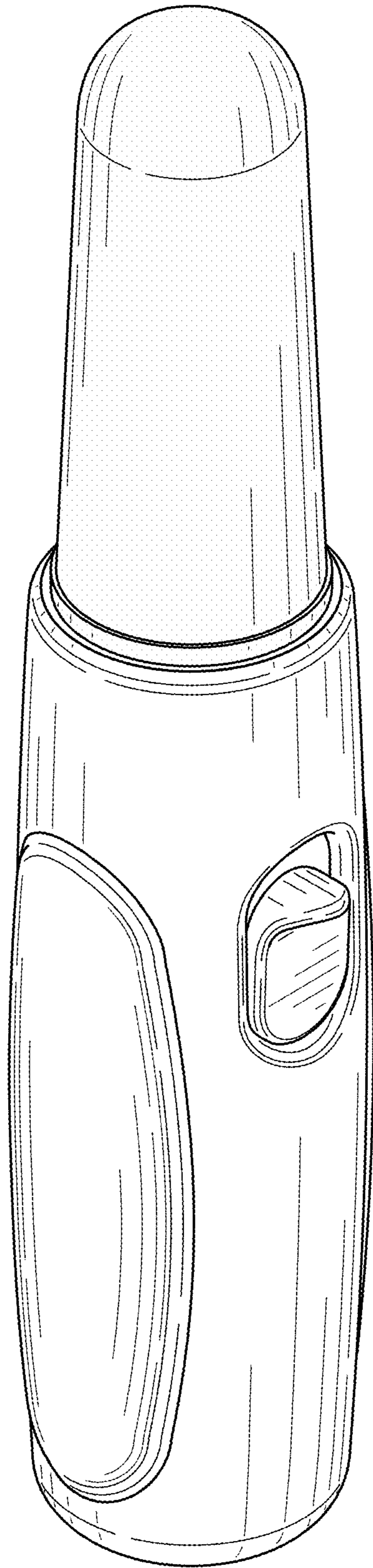

FIG. 1

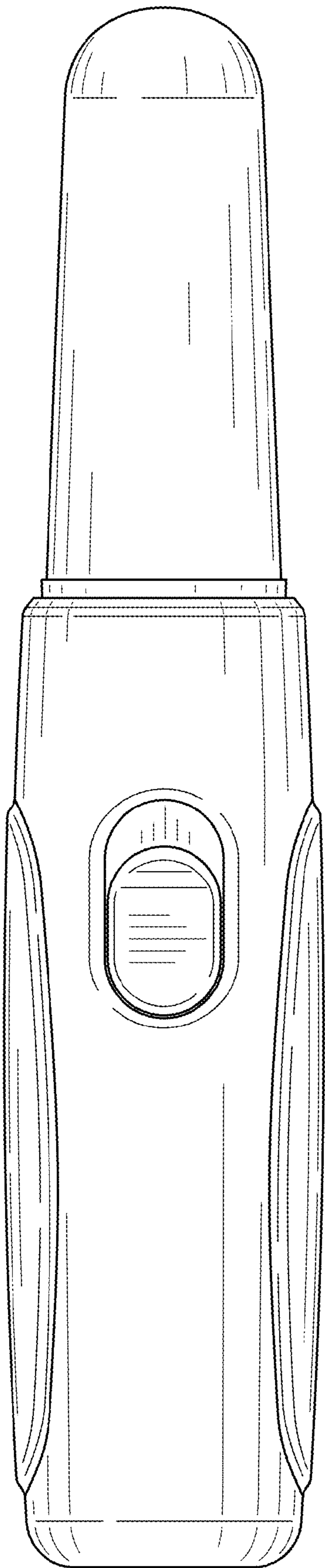

FIG. 2

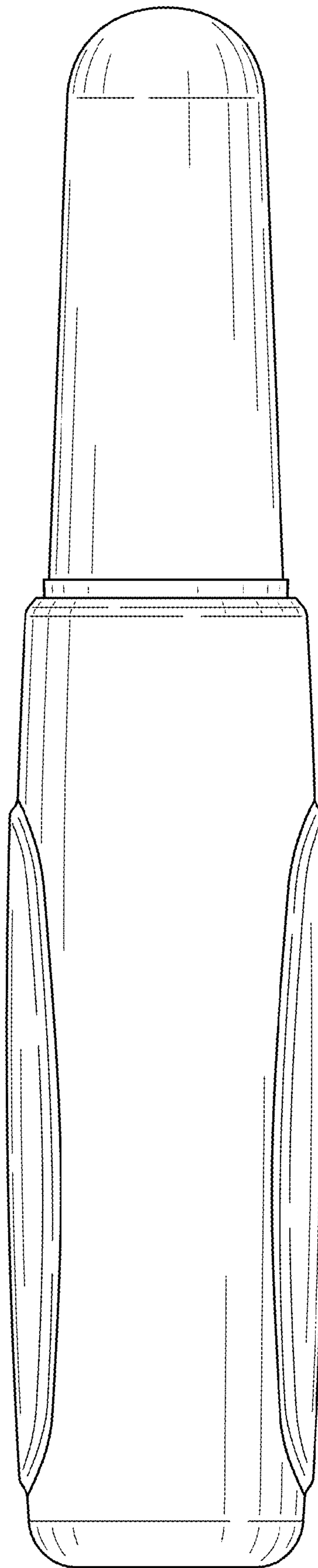

FIG. 3

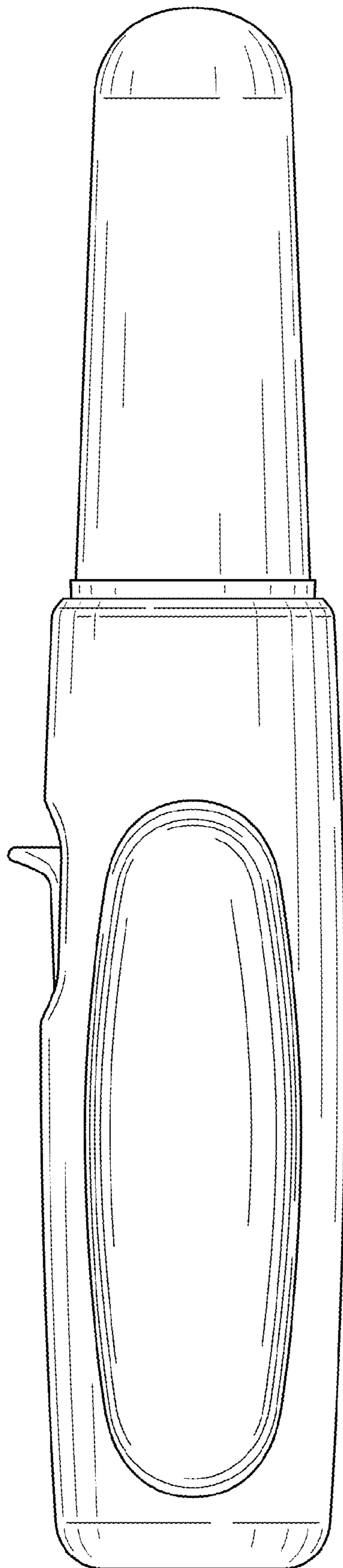

FIG. 4

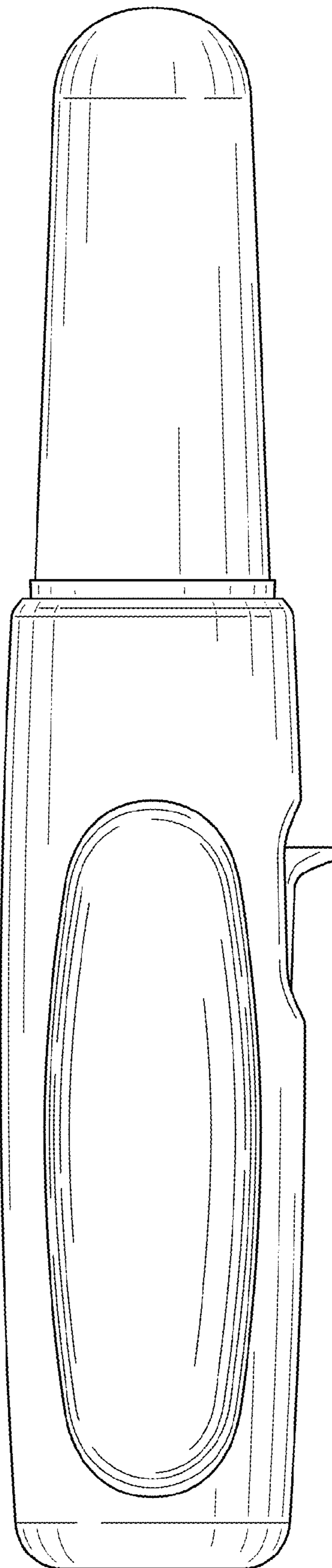

FIG. 5

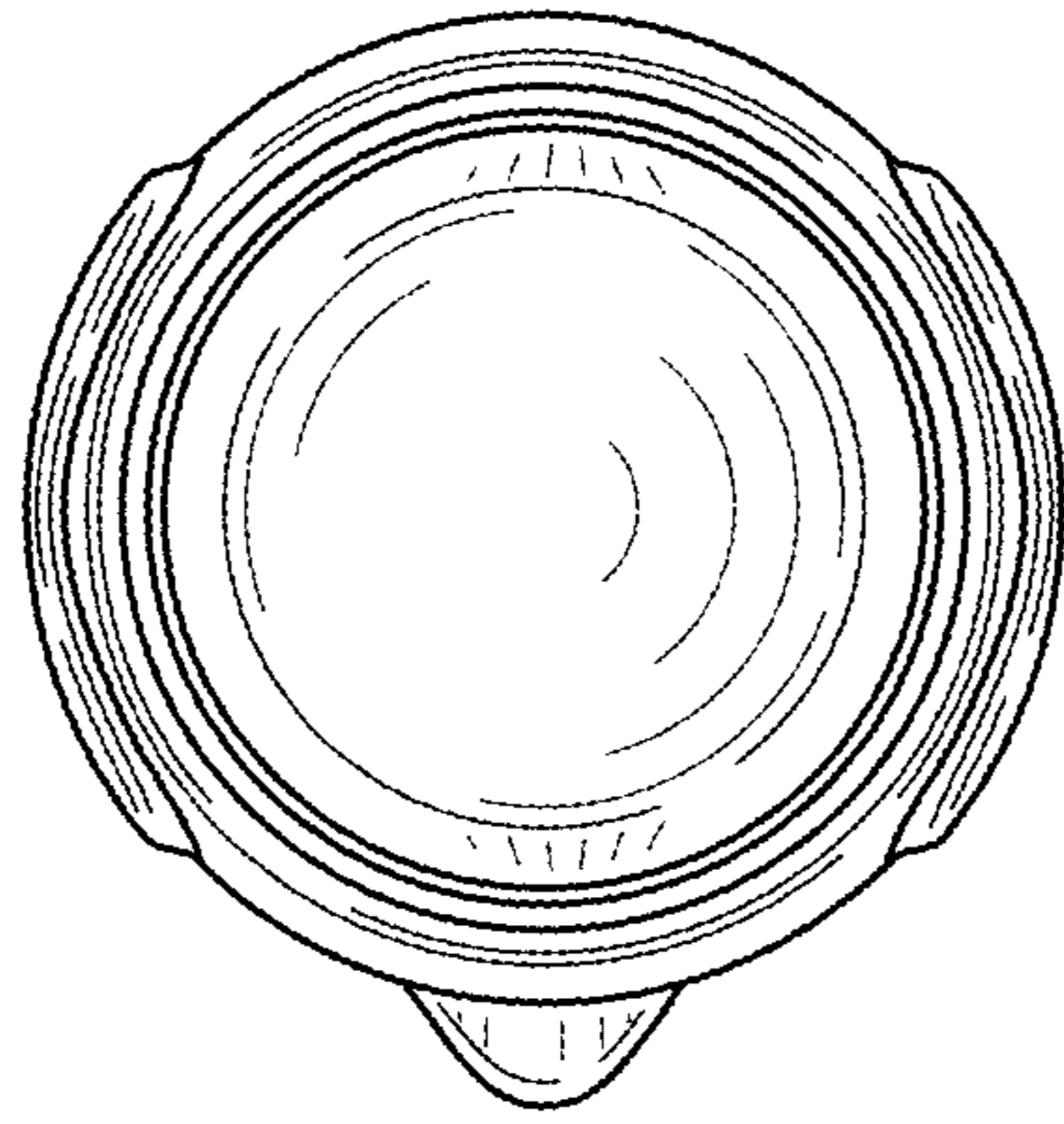

FIG. 6

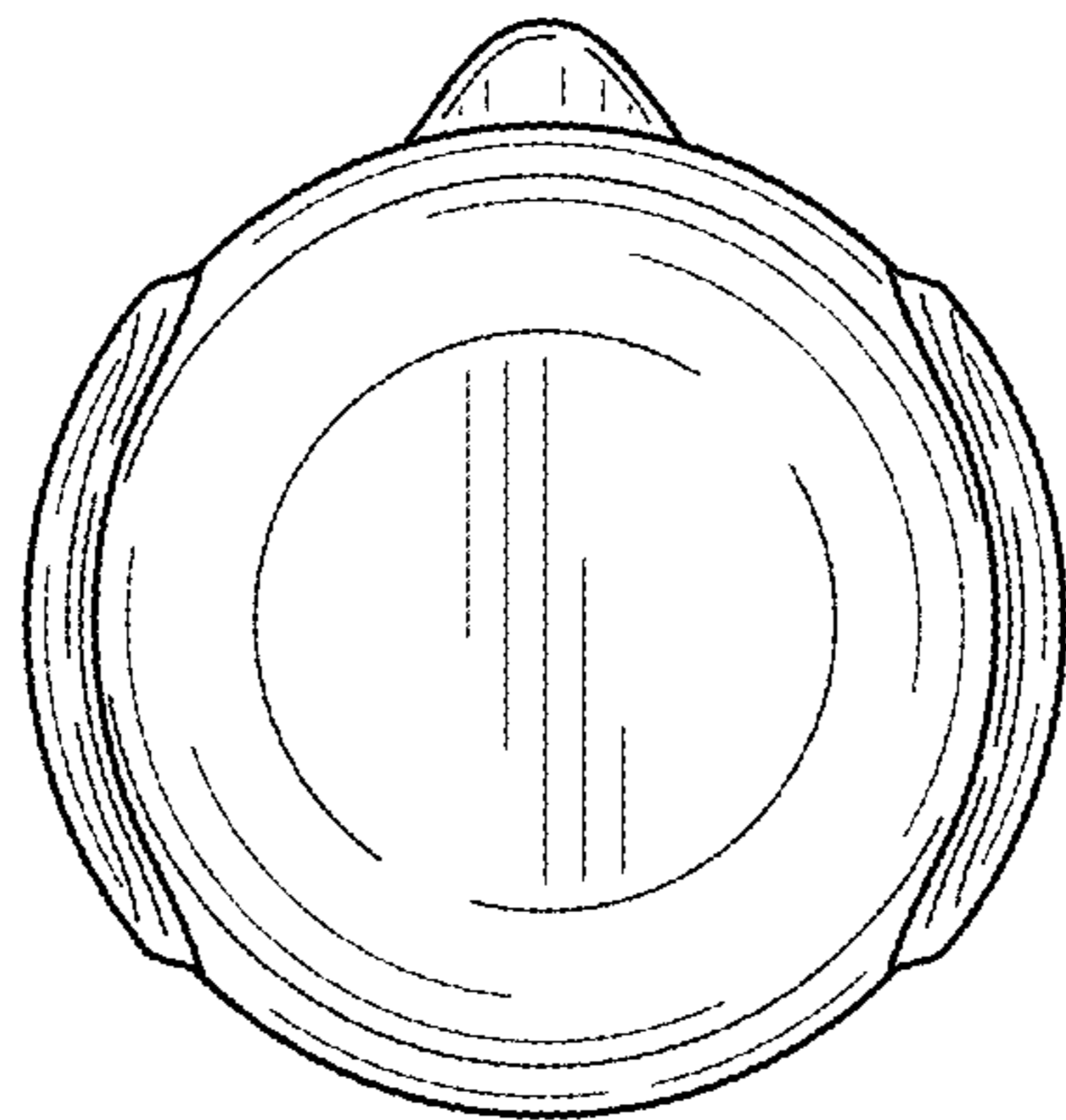

FIG. 7

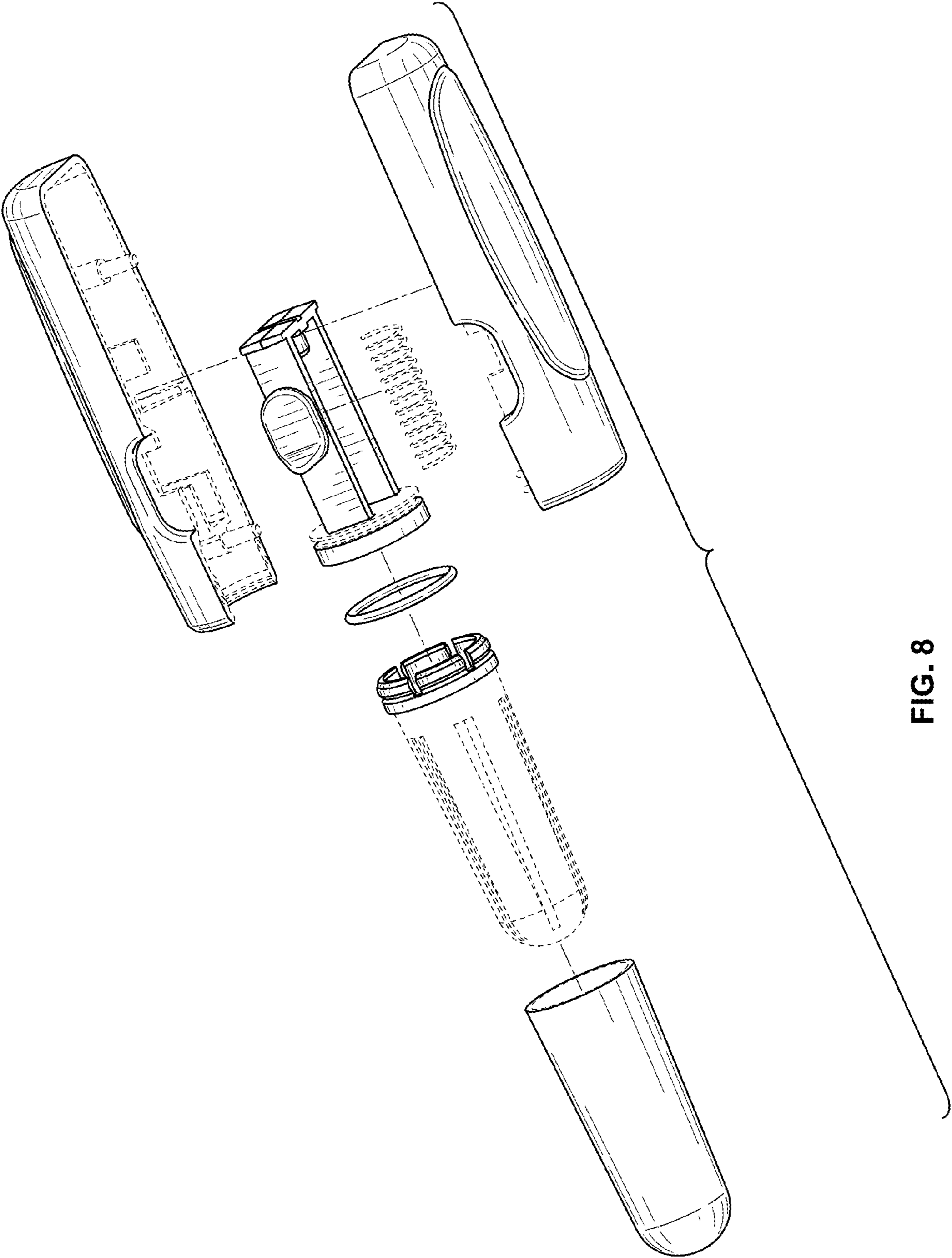

FIG. 8