



US00D917048S

(12) **United States Design Patent**  
**Moroney et al.**

(10) **Patent No.:** **US D917,048 S**

(45) **Date of Patent:** **\*\* Apr. 20, 2021**

- (54) **SURGICAL TOOL**
- (71) Applicant: **Stryker Corporation**, Kalamazoo, MI (US)
- (72) Inventors: **Jonathan Moroney**, Grand Haven, MI (US); **Rich Harris**, Kentwood, MI (US); **Mark Ryan**, Milwaukee, WI (US)
- (73) Assignee: **Stryker Corporation**, Kalamazoo, MI (US)

- 6,572,593 B1 6/2003 Daum
- 6,592,559 B1 7/2003 Pakter et al.
- 7,731,692 B2 \* 6/2010 Moos ..... A61B 10/025  
604/164.08
- D646,783 S \* 10/2011 Bast ..... D24/133
- D648,433 S \* 11/2011 Bast ..... D24/133
- D669,168 S \* 10/2012 Krueger ..... D24/112

\* cited by examiner

*Primary Examiner* — Mark Booker

(74) *Attorney, Agent, or Firm* — Howard & Howard Attorneys PLLC

(\*\*) Term: **15 Years**

(57) **CLAIM**

(21) Appl. No.: **29/645,613**

An ornamental design for a surgical tool, as shown and described.

(22) Filed: **Apr. 27, 2018**

**DESCRIPTION**

(51) **LOC (13) Cl.** ..... **24-02**

(52) **U.S. Cl.**  
USPC ..... **D24/133**

(58) **Field of Classification Search**  
USPC ..... D24/133, 111, 112, 130, 143–144, 146, D24/147, 148; D7/649; D8/93, 97, 300, D8/310, 311, 313, 83, 107; D19/110, D19/115; 600/554, 547, 562, 564, 566, 600/567; 604/158, 164, 164.08, 165, 166, 604/167, 168, 170, 188, 198, 263, 264; 606/79, 80, 83, 142, 167, 170, 172, 174, 606/184, 205–208; 607/116  
CPC ..... A61M 5/178; A61B 10/00; A61B 17/14; A61B 5/00  
See application file for complete search history.

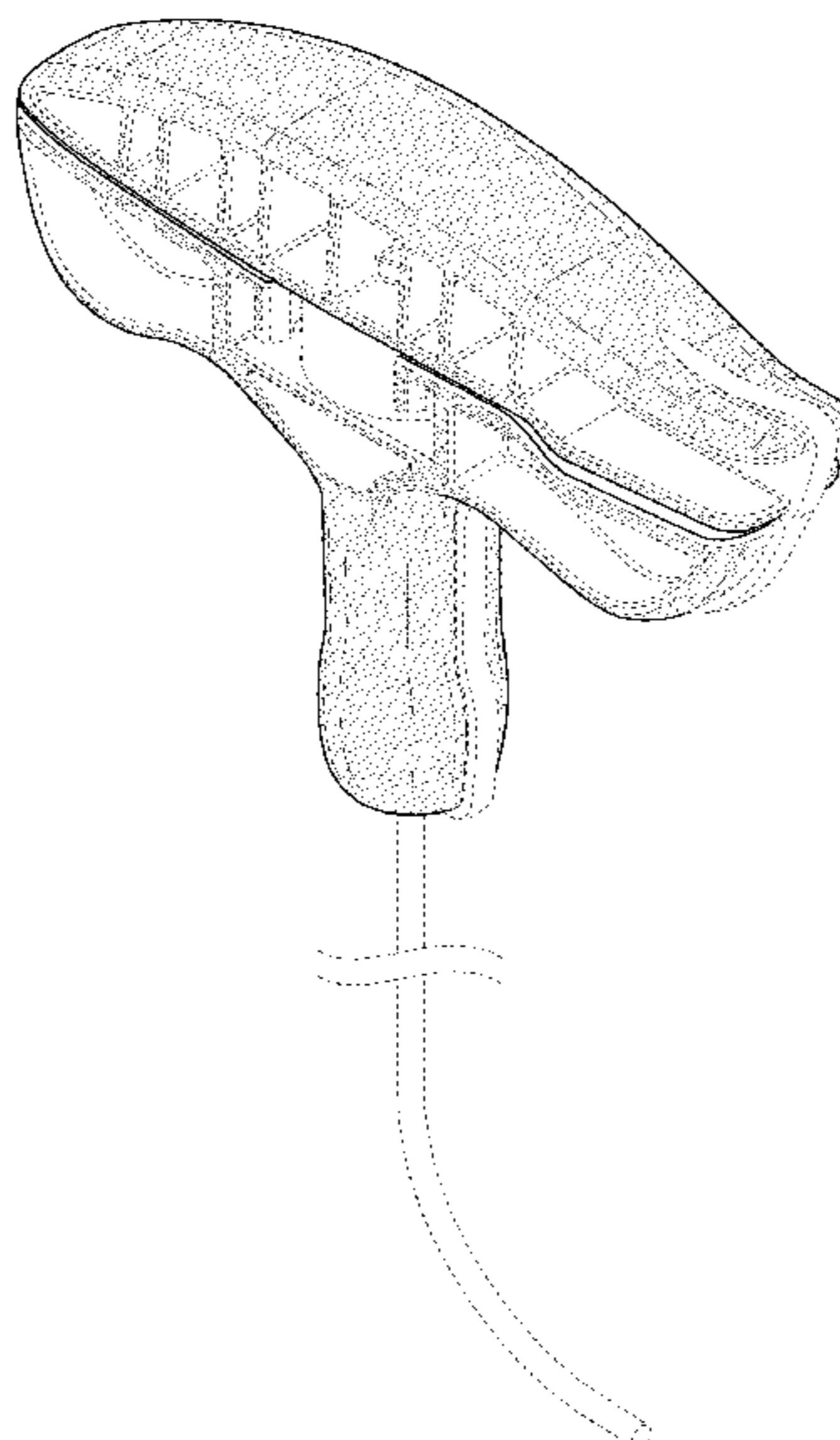
FIG. 1 is a top, front perspective view of a first embodiment of a surgical tool;  
FIG. 2 is a bottom, front perspective view of the surgical tool of FIG. 1;  
FIG. 3 is a bottom, rear perspective view of the surgical tool of FIG. 1;  
FIG. 4 is a front elevational view of the surgical tool of FIG. 1;  
FIG. 5 is a rear elevational view of the surgical tool of FIG. 1;  
FIG. 6 is a left side elevational view of the surgical tool of FIG. 1;  
FIG. 7 is a right side elevational view of the surgical tool of FIG. 1;  
FIG. 8 is a top plan view of the surgical tool of FIG. 1; and, FIG. 9 is a bottom plan view of the surgical tool of FIG. 1. The broken lines, depicted as dashed lines, are included for purposes of illustrating optional features of the surgical tool and form no part of the claimed design. The stippled surface shading shown throughout the figures depicts claimed surface area of the surgical tool.

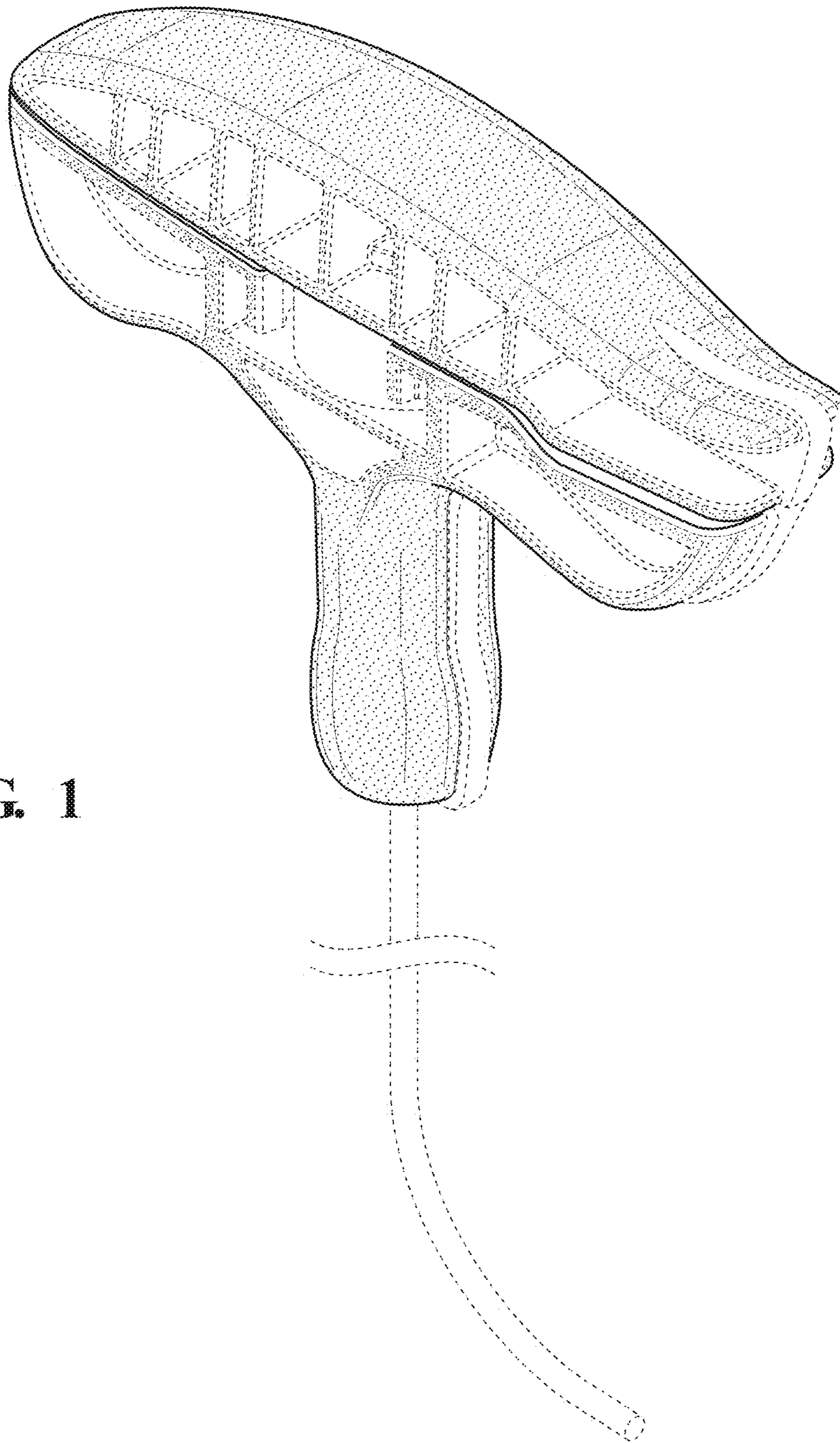
(56) **References Cited**

U.S. PATENT DOCUMENTS

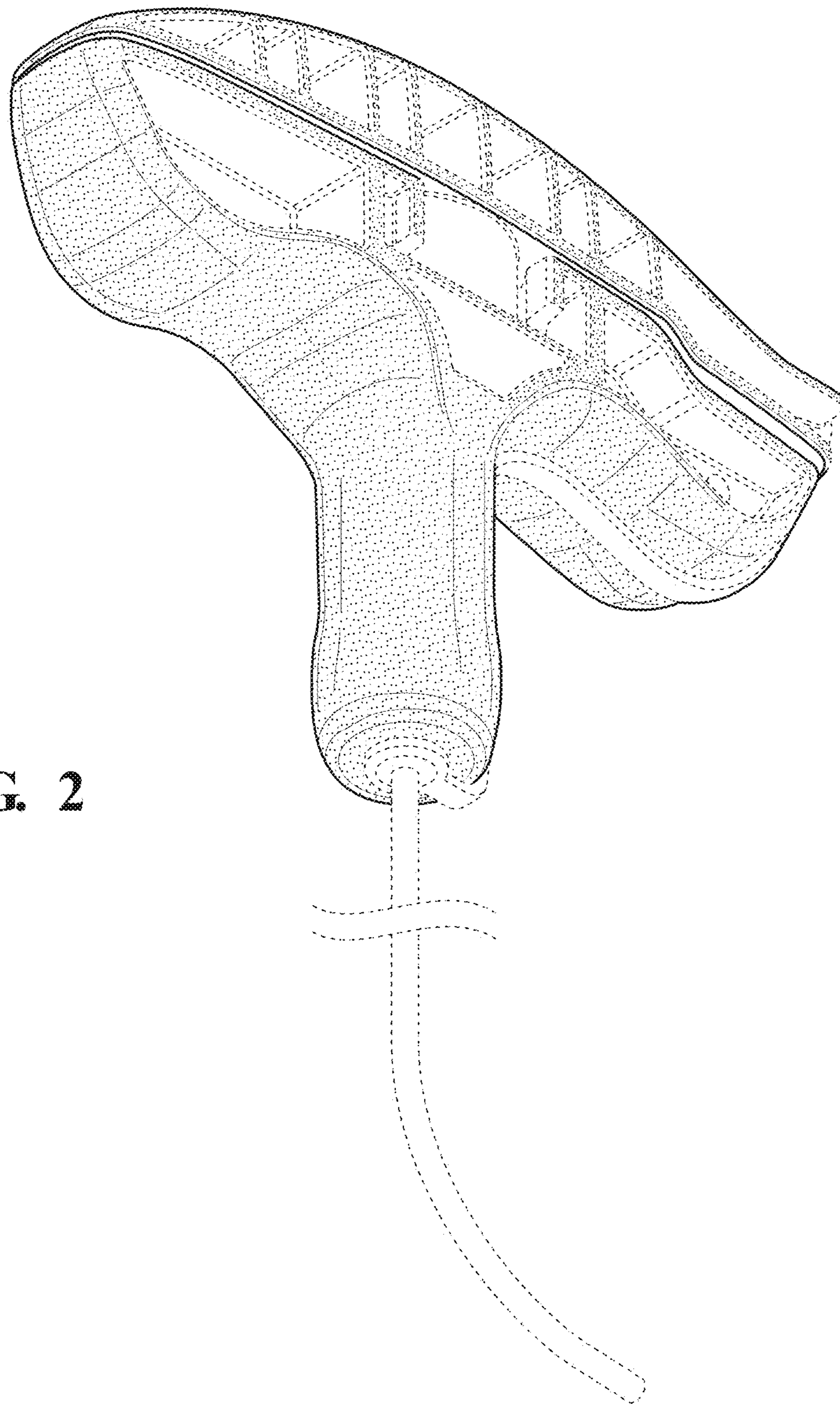
- D289,198 S \* 4/1987 Karten ..... D24/114
- 4,838,282 A 6/1989 Strasser et al.
- 5,720,754 A 2/1998 Middleman et al.
- 5,830,188 A 11/1998 Abouleish
- D402,029 S \* 12/1998 Shinabarger ..... D24/146

**1 Claim, 7 Drawing Sheets**



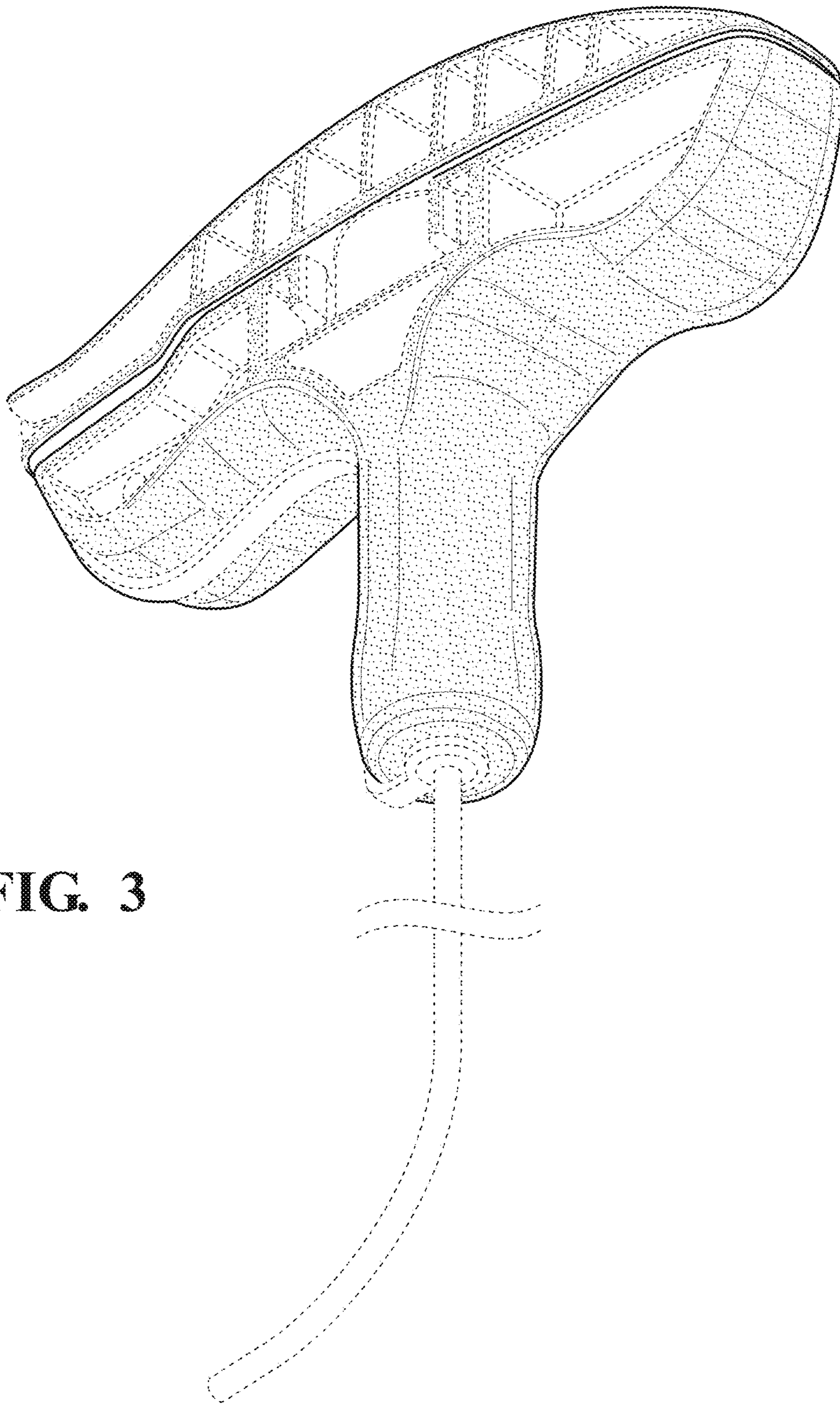


**FIG. 1**

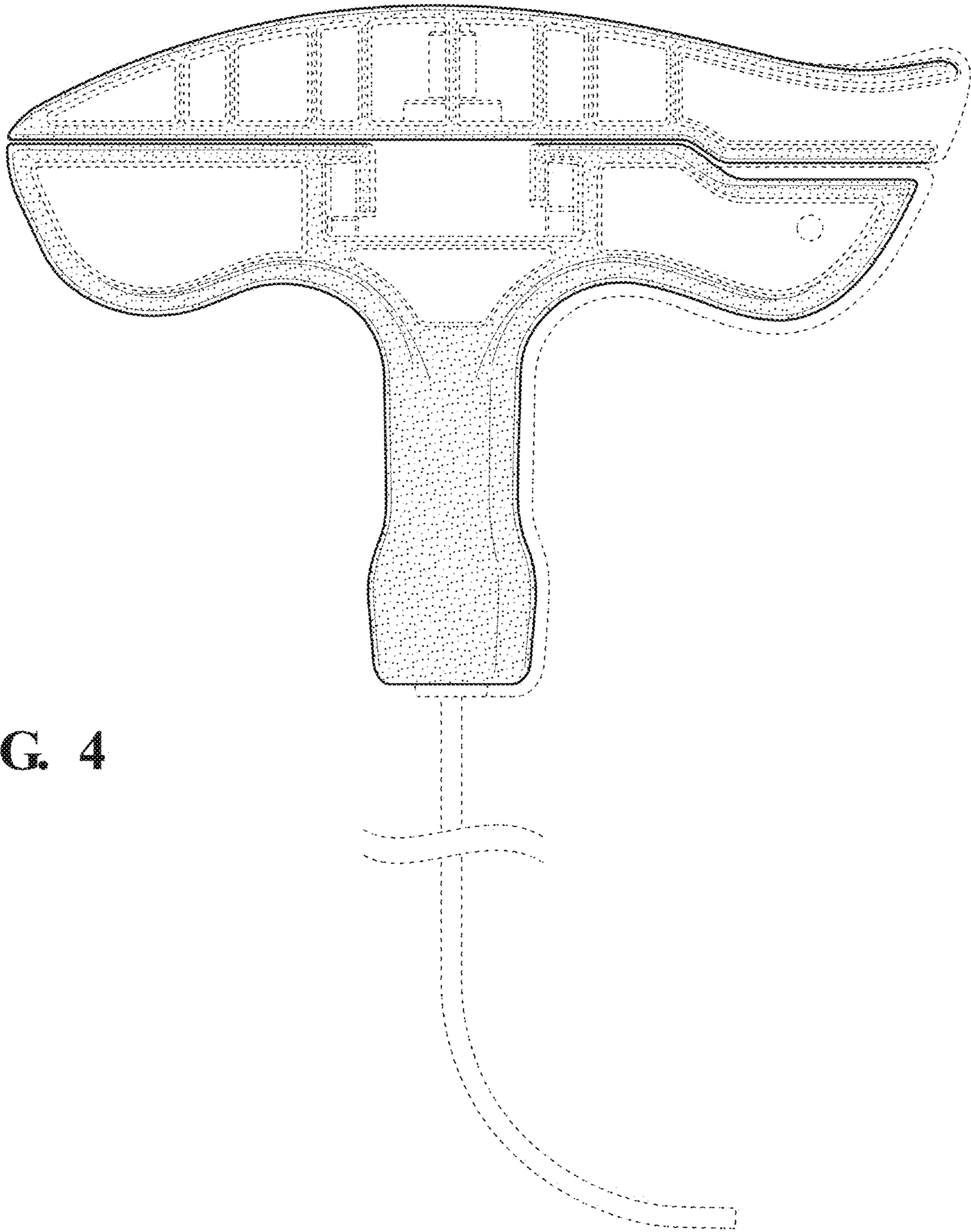


**FIG. 2**

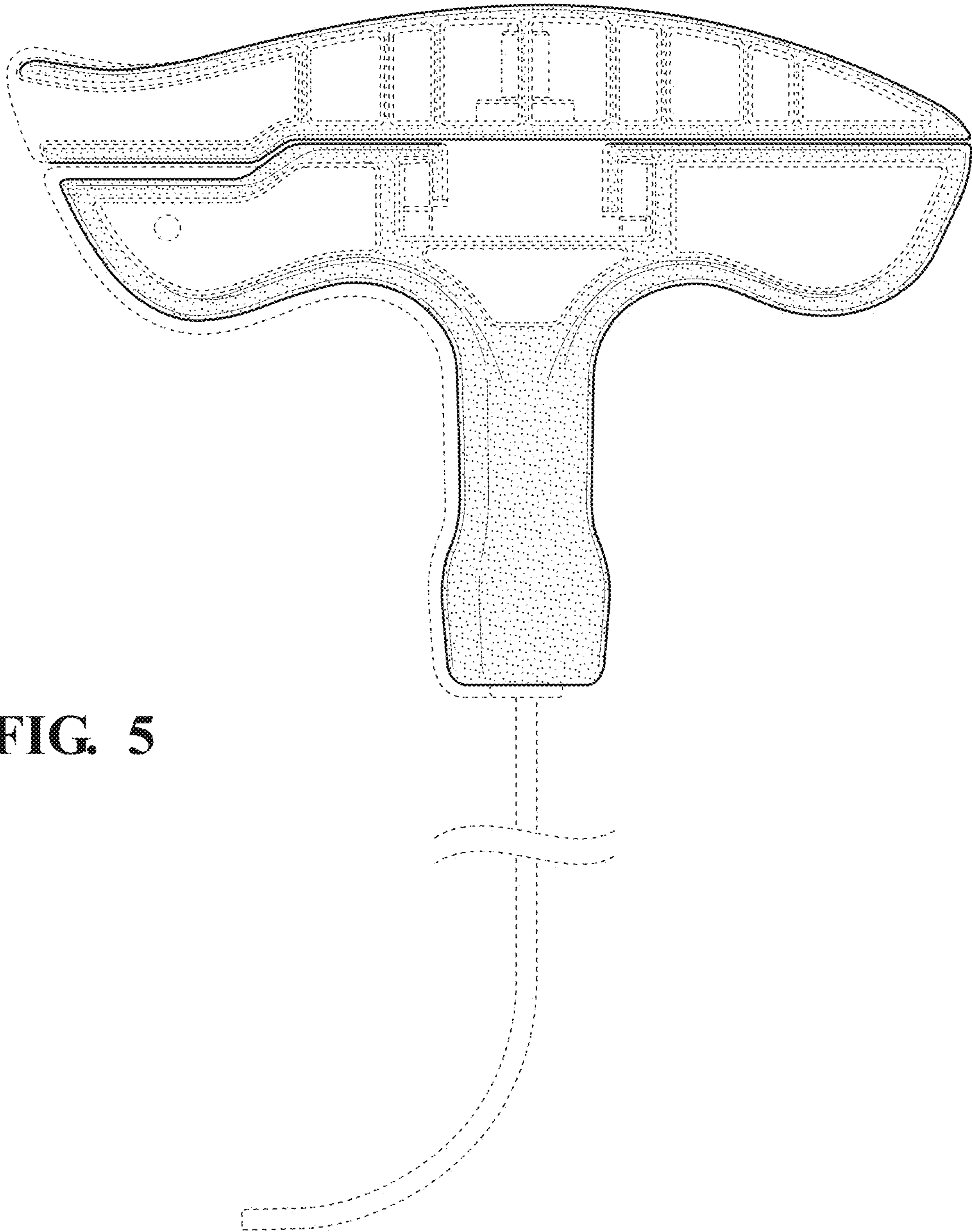




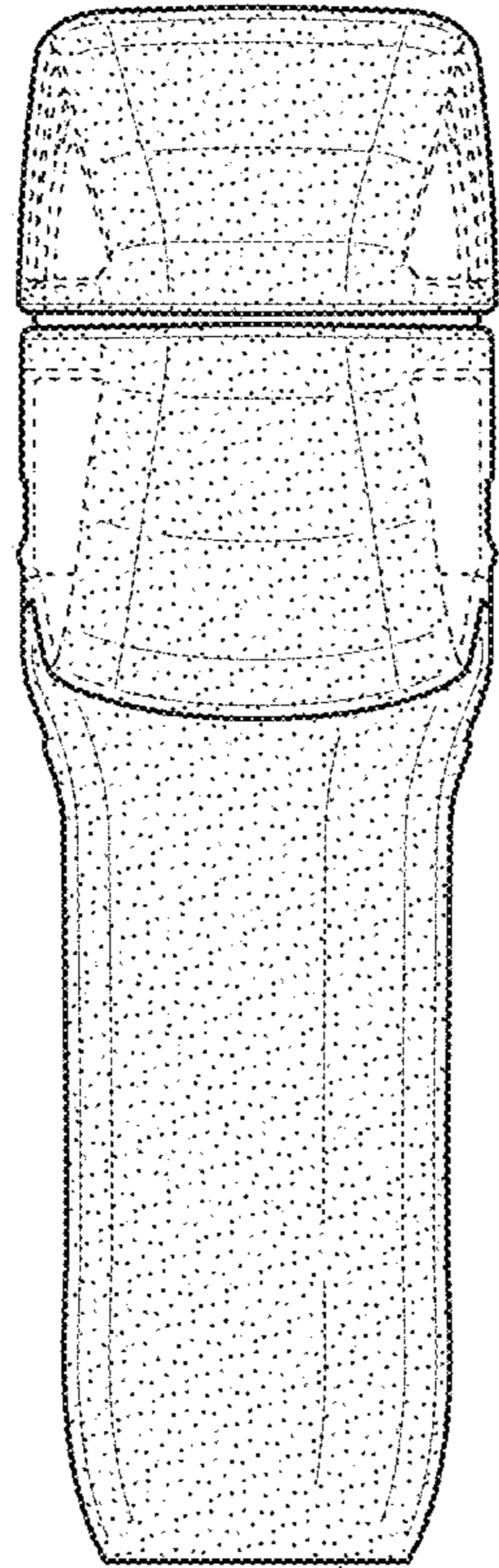
**FIG. 3**



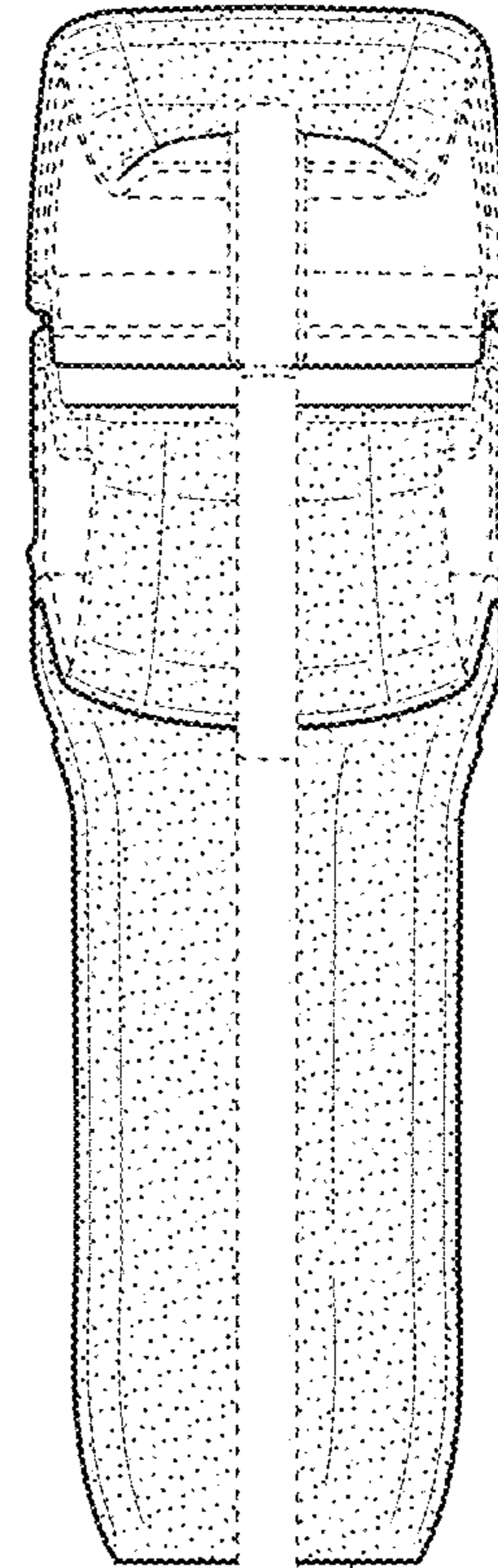
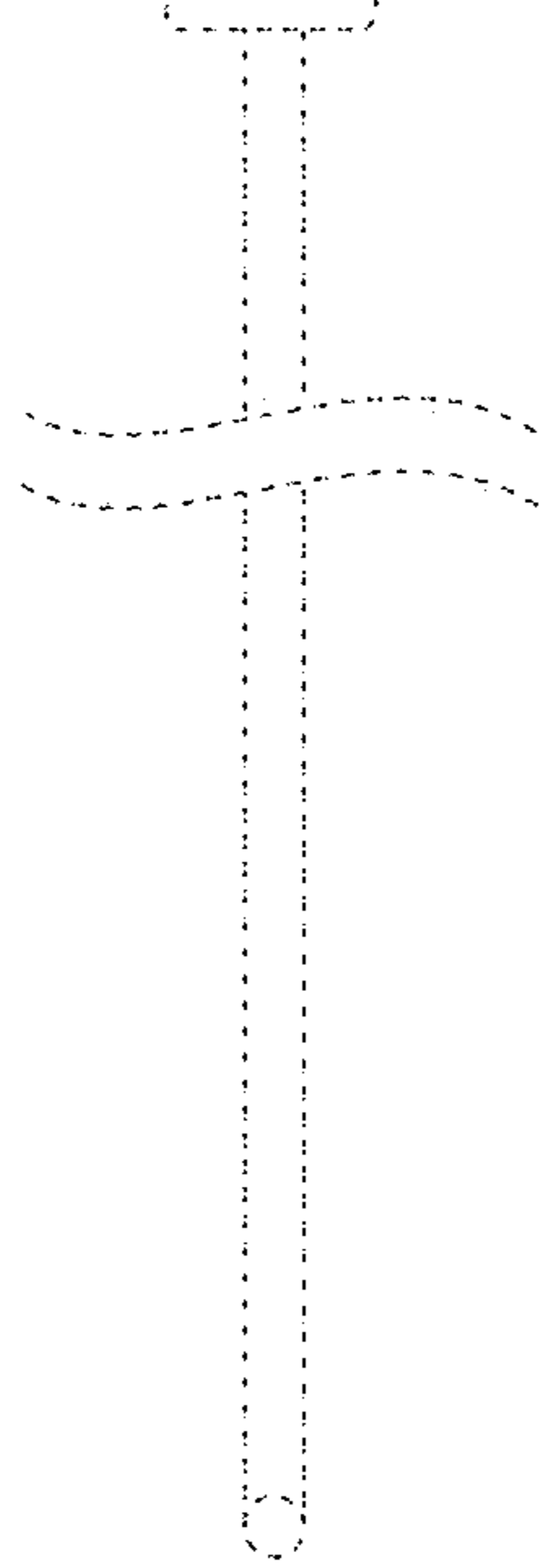
**FIG. 4**



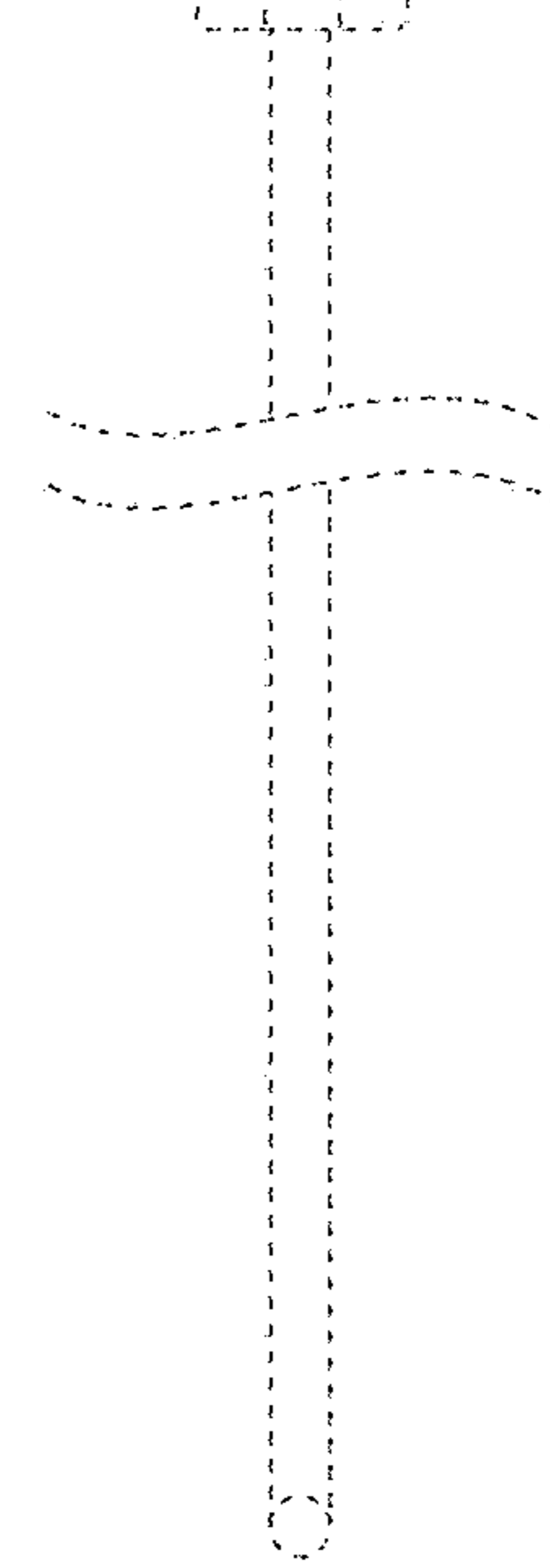
**FIG. 5**



**FIG. 6**



**FIG. 7**





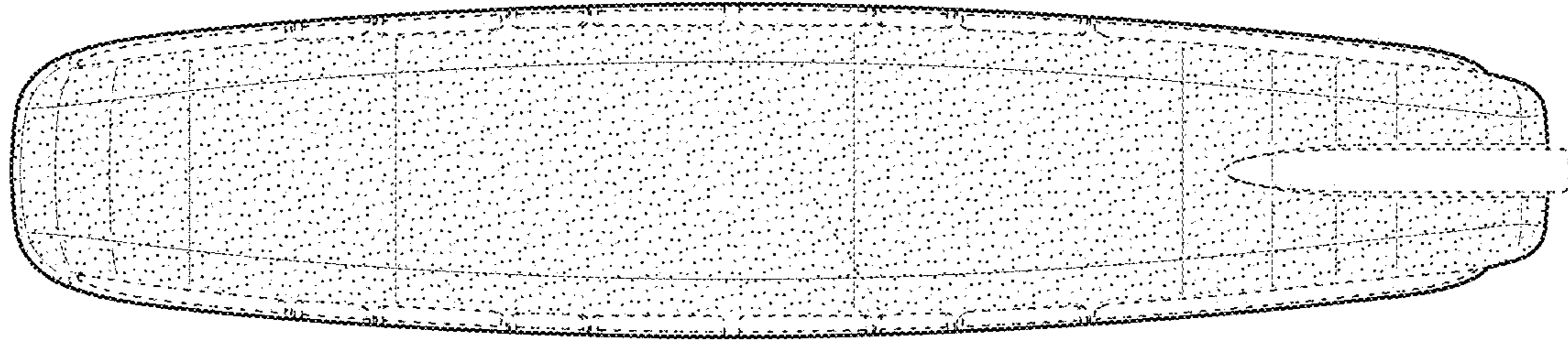


FIG. 8

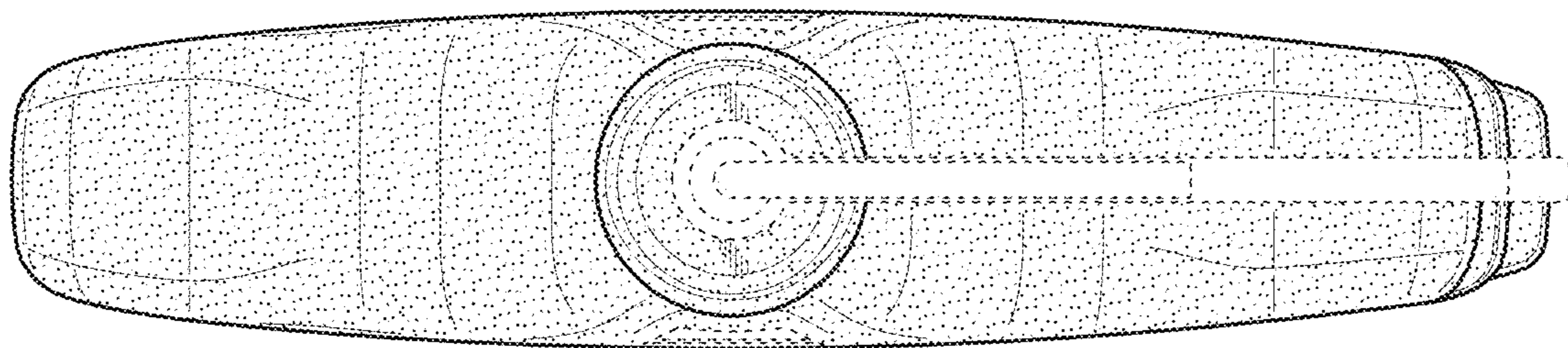


FIG. 9