



US00D917009S

(12) **United States Design Patent**  
**Wu**

(10) **Patent No.:** **US D917,009 S**  
(45) **Date of Patent:** **\*\* Apr. 20, 2021**

(54) **BUG ZAPPER**

- (71) Applicant: **Ting Wu**, Shenzhen (CN)
- (72) Inventor: **Ting Wu**, Shenzhen (CN)
- (\*\*) Term: **15 Years**
- (21) Appl. No.: **29/757,166**
- (22) Filed: **Nov. 4, 2020**
- (51) **LOC (13) Cl.** ..... **22-06**
- (52) **U.S. Cl.**  
USPC ..... **D22/123**
- (58) **Field of Classification Search**  
USPC ..... D22/122–123, 120; 43/107, 112–114,  
43/121–122, 131, 132.1; D26/37–38, 41;  
362/157, 162, 171, 178; 340/552, 556,  
340/561, 573.2  
CPC ..... A01M 1/04; A01M 1/08; A01M 1/023;  
A01M 1/026; A01M 1/223; A01M  
2200/012; F21L 2003/00  
See application file for complete search history.

(56) **References Cited**

**U.S. PATENT DOCUMENTS**

4,182,069	A *	1/1980	De Yoreo	.....	A01M 1/04 43/112
D469,501	S	1/2003	Levine		
D828,900	S *	9/2018	Le Laidier	.....	D22/123
D899,556	S	10/2020	Du		
D900,957	S *	11/2020	Du	.....	D22/123
2009/0277073	A1 *	11/2009	Chen	.....	A01M 1/223 43/112

**OTHER PUBLICATIONS**

Black+Decker Bug Zapper—Electric UV Insect Catcher & Killer for Flies, Mosquitos, Gnats & Other Small to Large Flying Pests—1 Acre Outdoor Coverage for Home, Deck, Garden, Patio, Camping & More . . . [https://www.amazon.com/BLACK-DECKER-Electric-Mosquitoes-Coverage/dp/B084Q29MC3/ref=sr\\_1\\_182?crd=37ATDN.\\*](https://www.amazon.com/BLACK-DECKER-Electric-Mosquitoes-Coverage/dp/B084Q29MC3/ref=sr_1_182?crd=37ATDN.*)  
Mosquitoes—Coverage/dp/B084Q29MC3/ref=sr\_1\_182?crd=37ATDN (Year: 2020).\*

\* cited by examiner

*Primary Examiner* — Catherine R Oliver-Garcia

(57) **CLAIM**

The ornamental design for a bug zapper, as shown and described.

**DESCRIPTION**

FIG. 1 is a perspective view of a bug zapper showing my new design;  
FIG. 2 is a front elevational view thereof;  
FIG. 3 is a rear elevational view thereof;  
FIG. 4 is a left side elevational view thereof;  
FIG. 5 is a right side elevational view thereof;  
FIG. 6 is a top plan view thereof; and,  
FIG. 7 is a bottom plan view thereof.  
The broken lines in the drawings depict portions of the bug zapper that form no part of the claimed design.

**1 Claim, 7 Drawing Sheets**

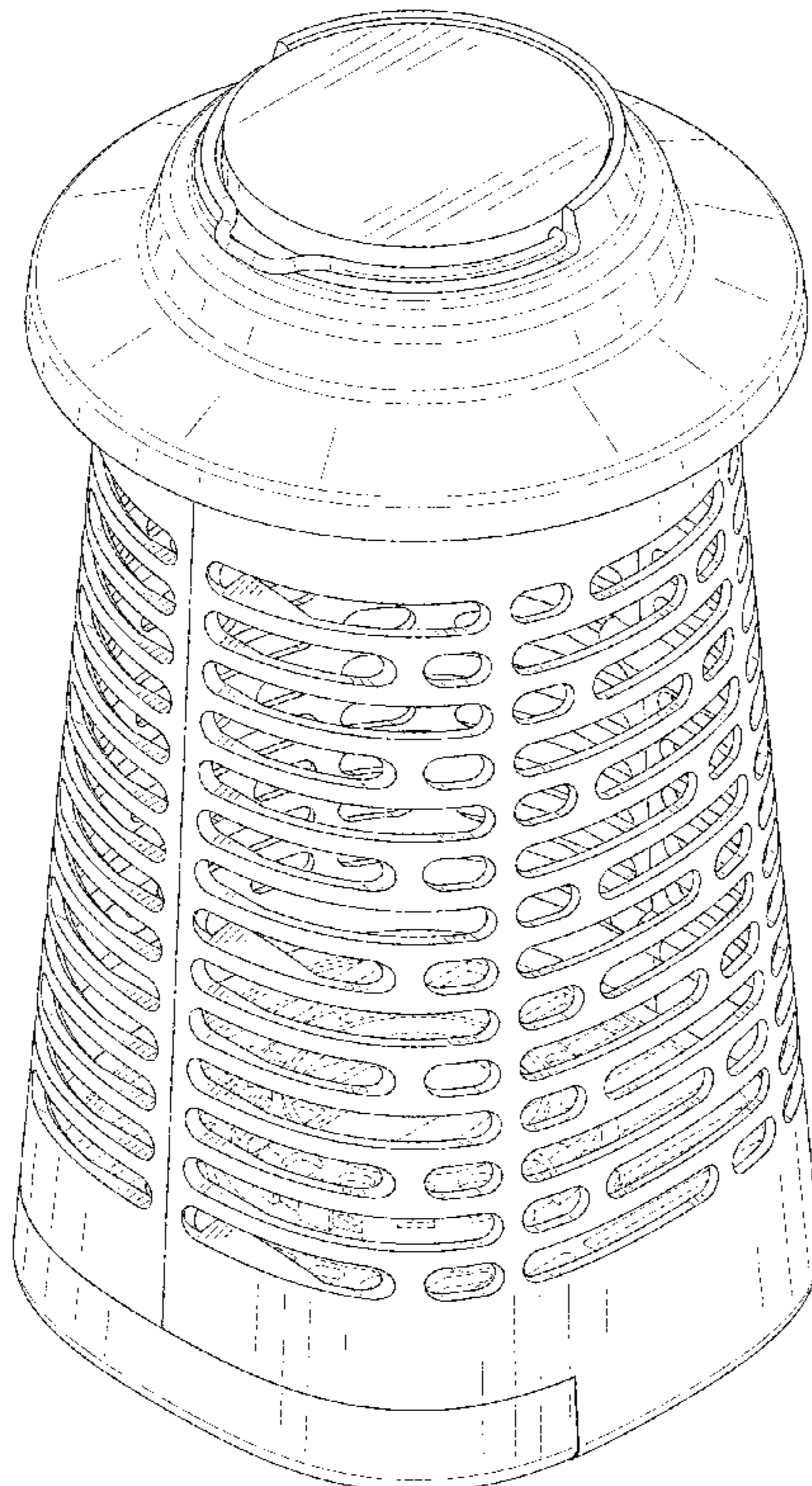

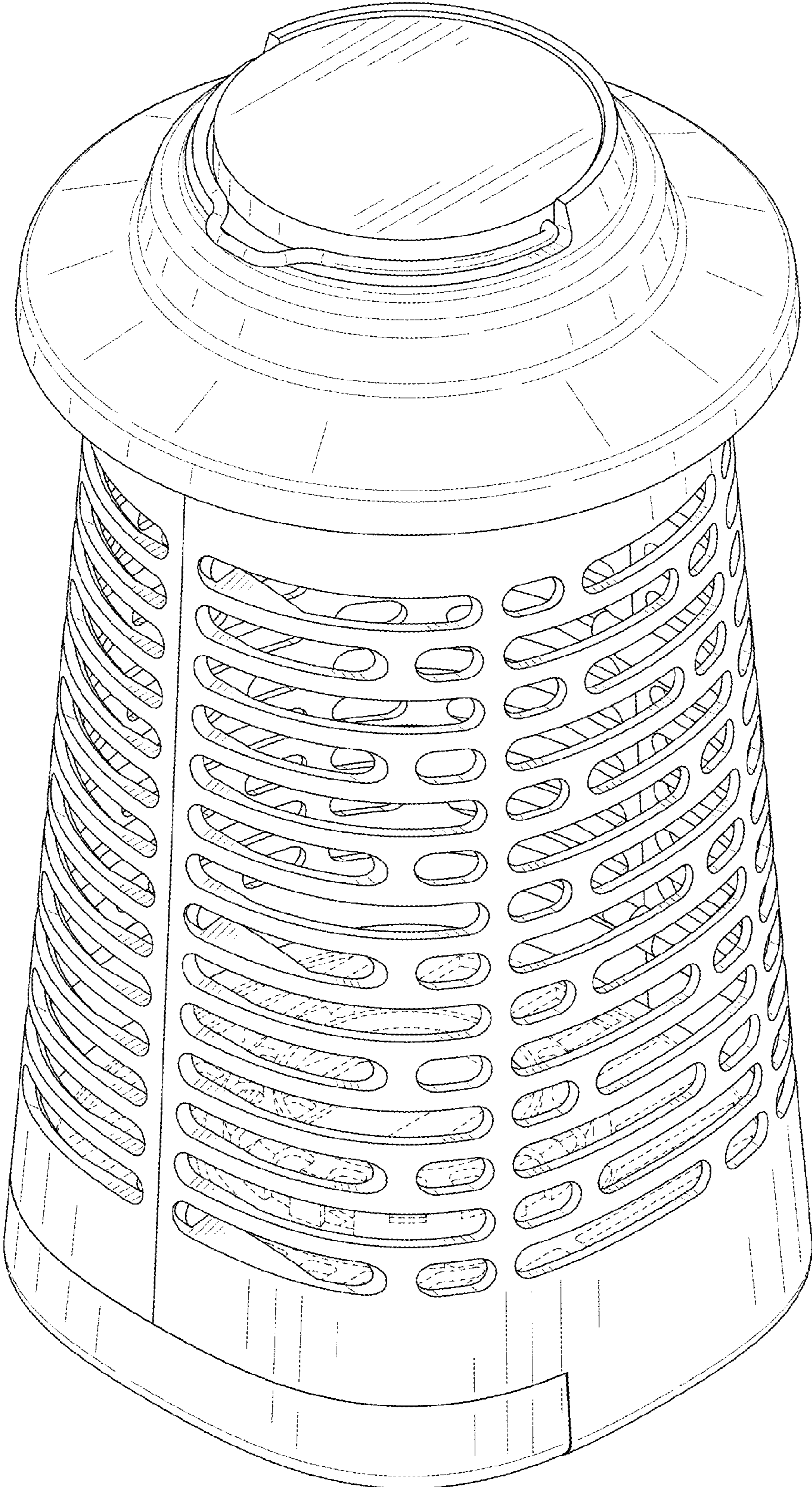

FIG. 1

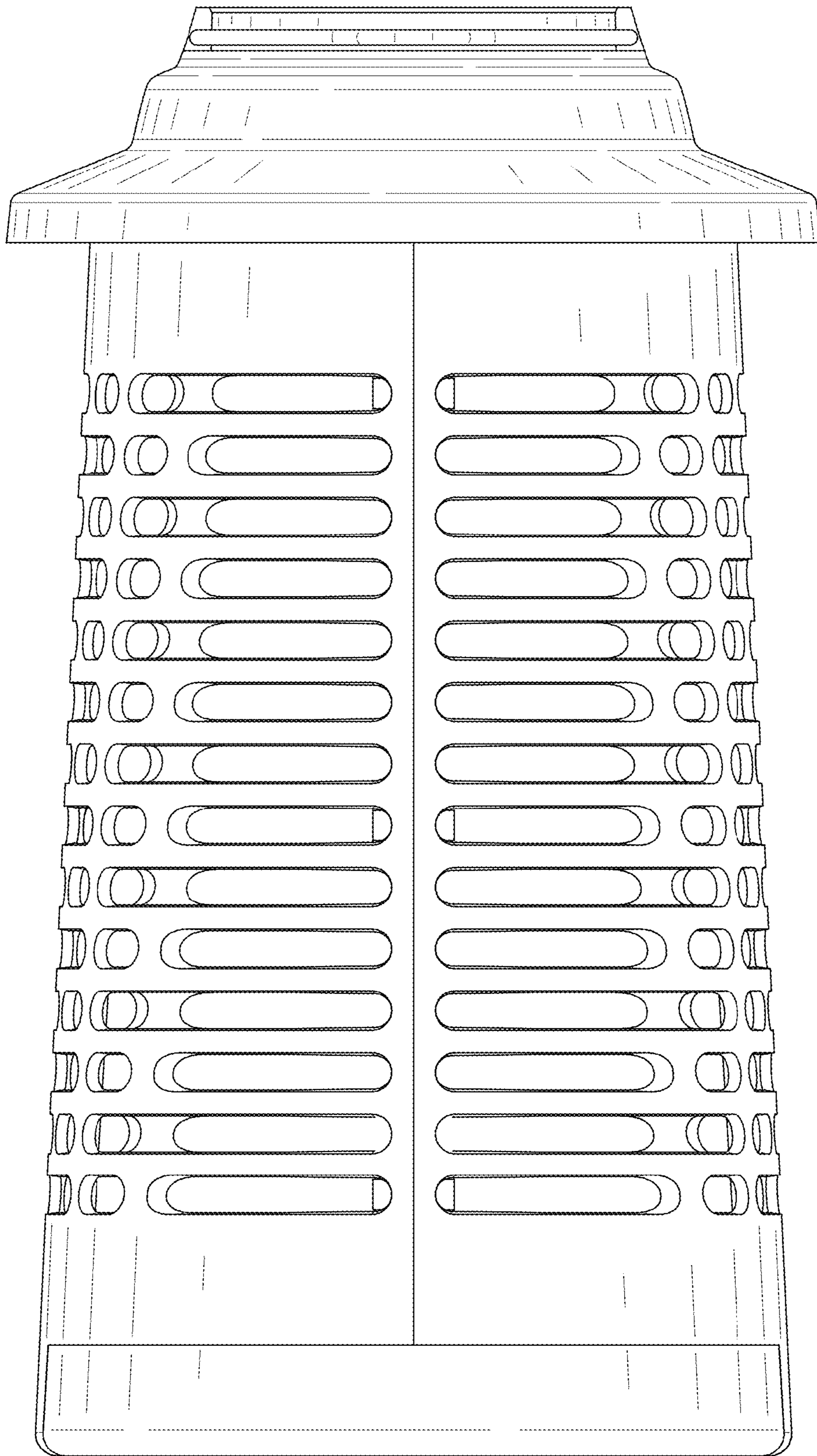

FIG. 2

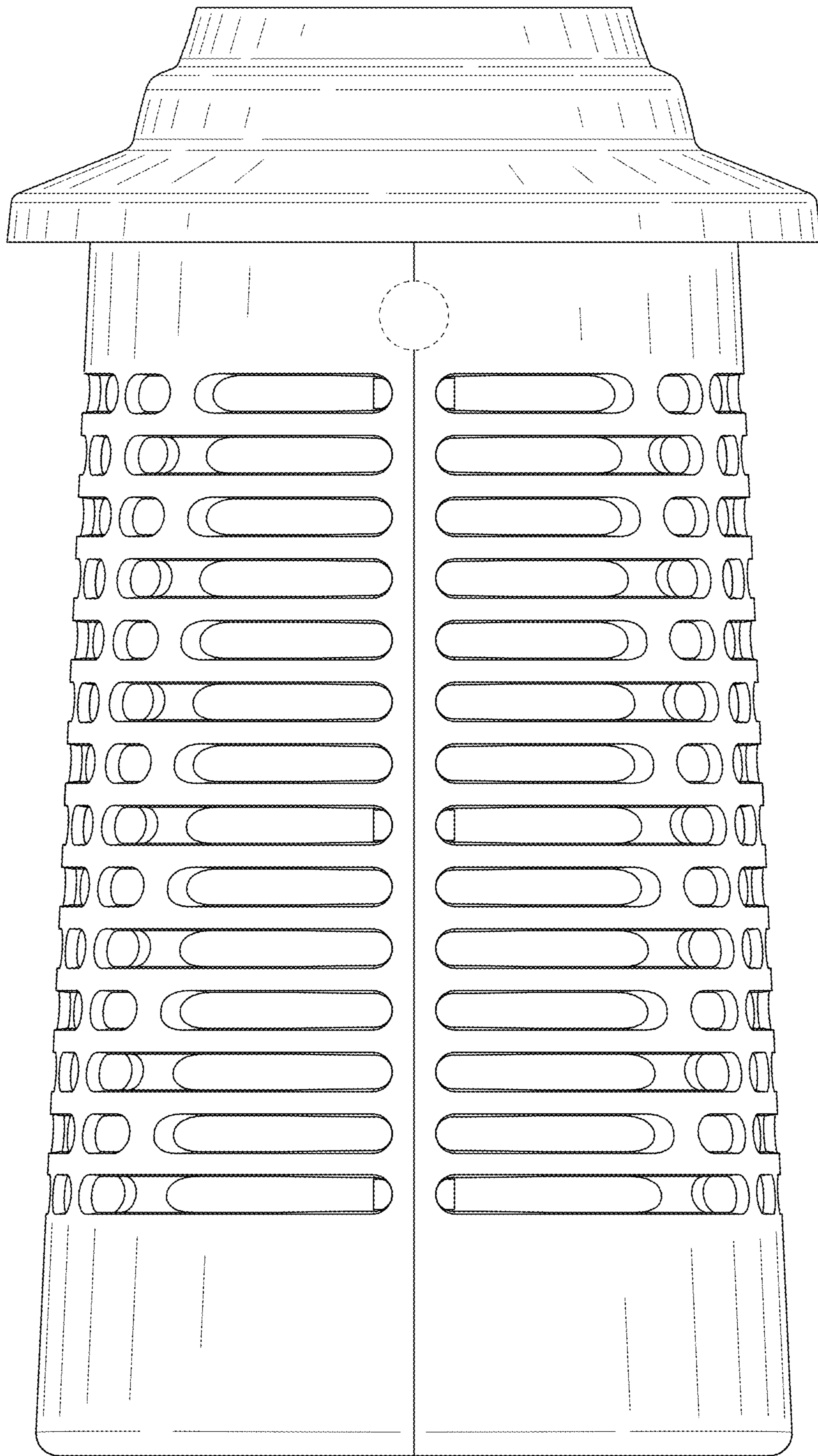

FIG. 3

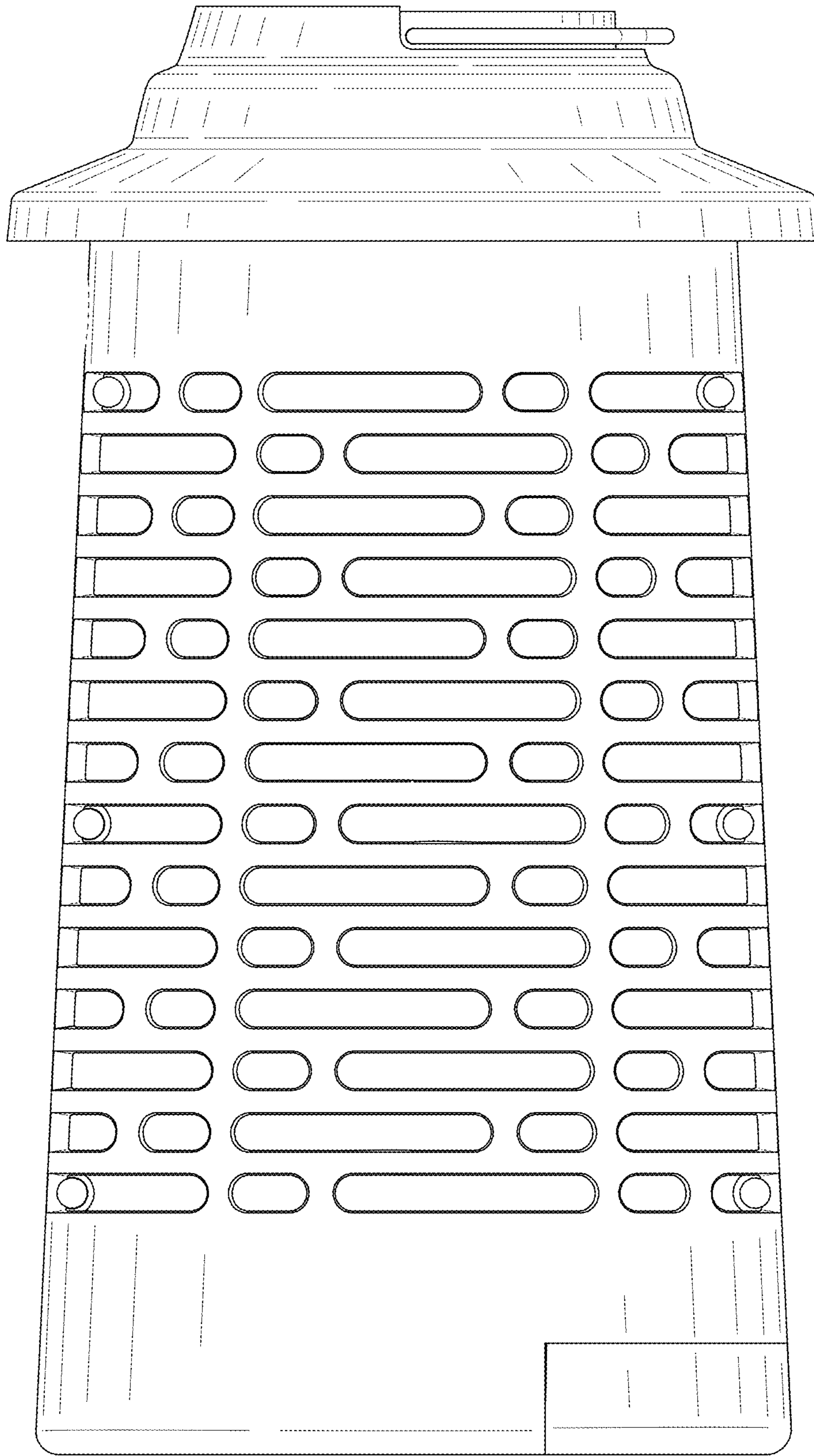

FIG. 4

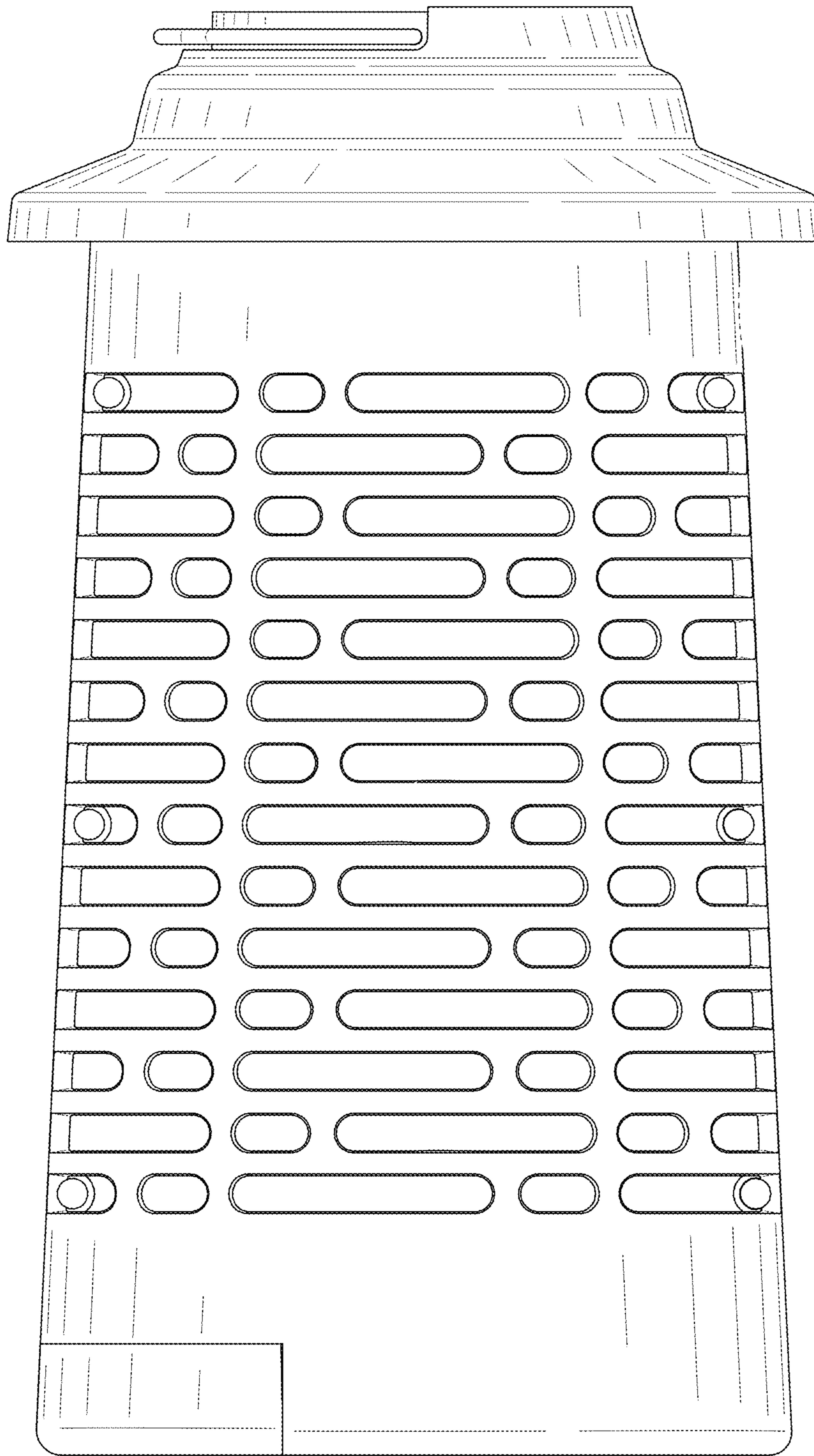

FIG. 5

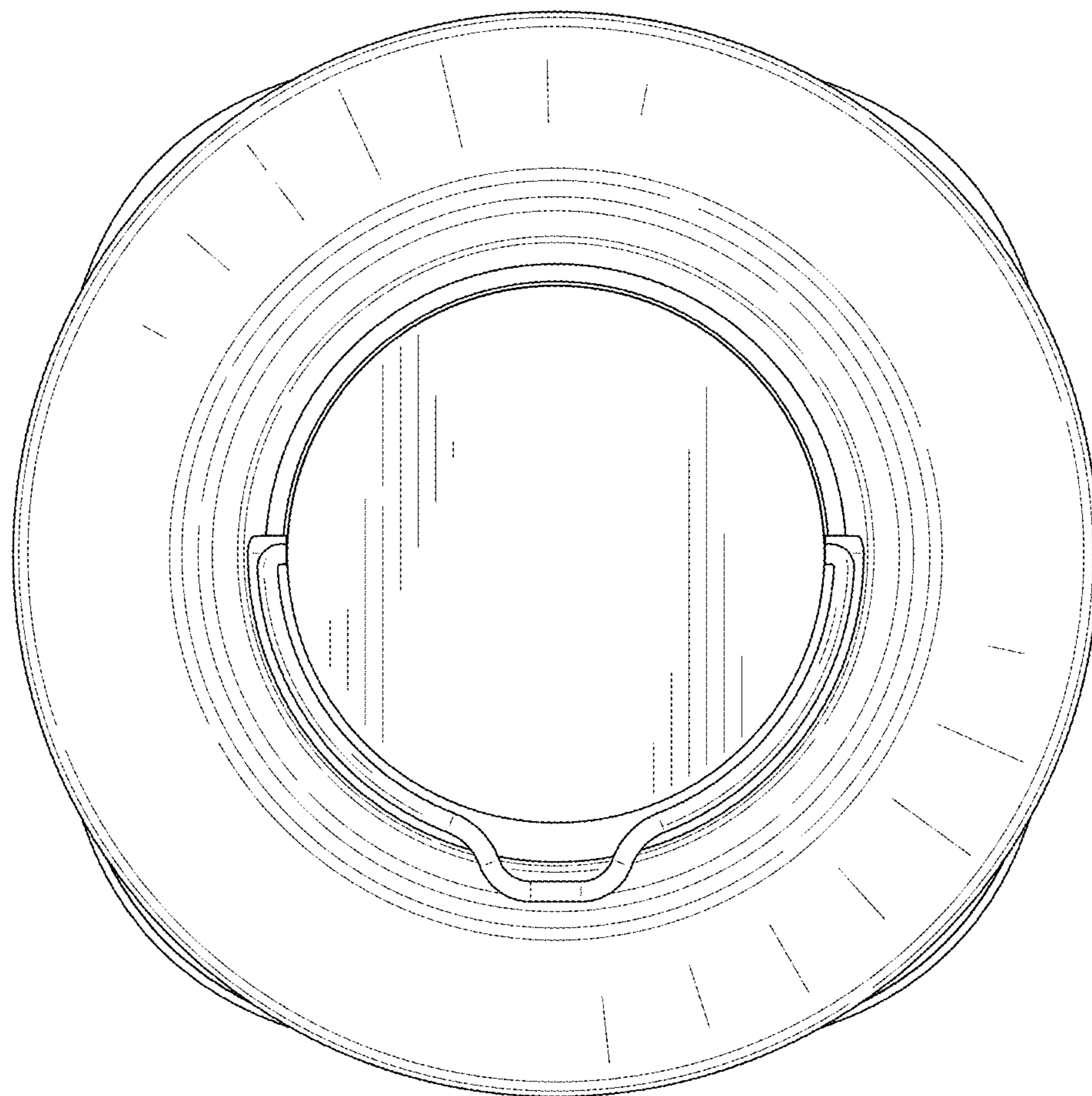

FIG. 6

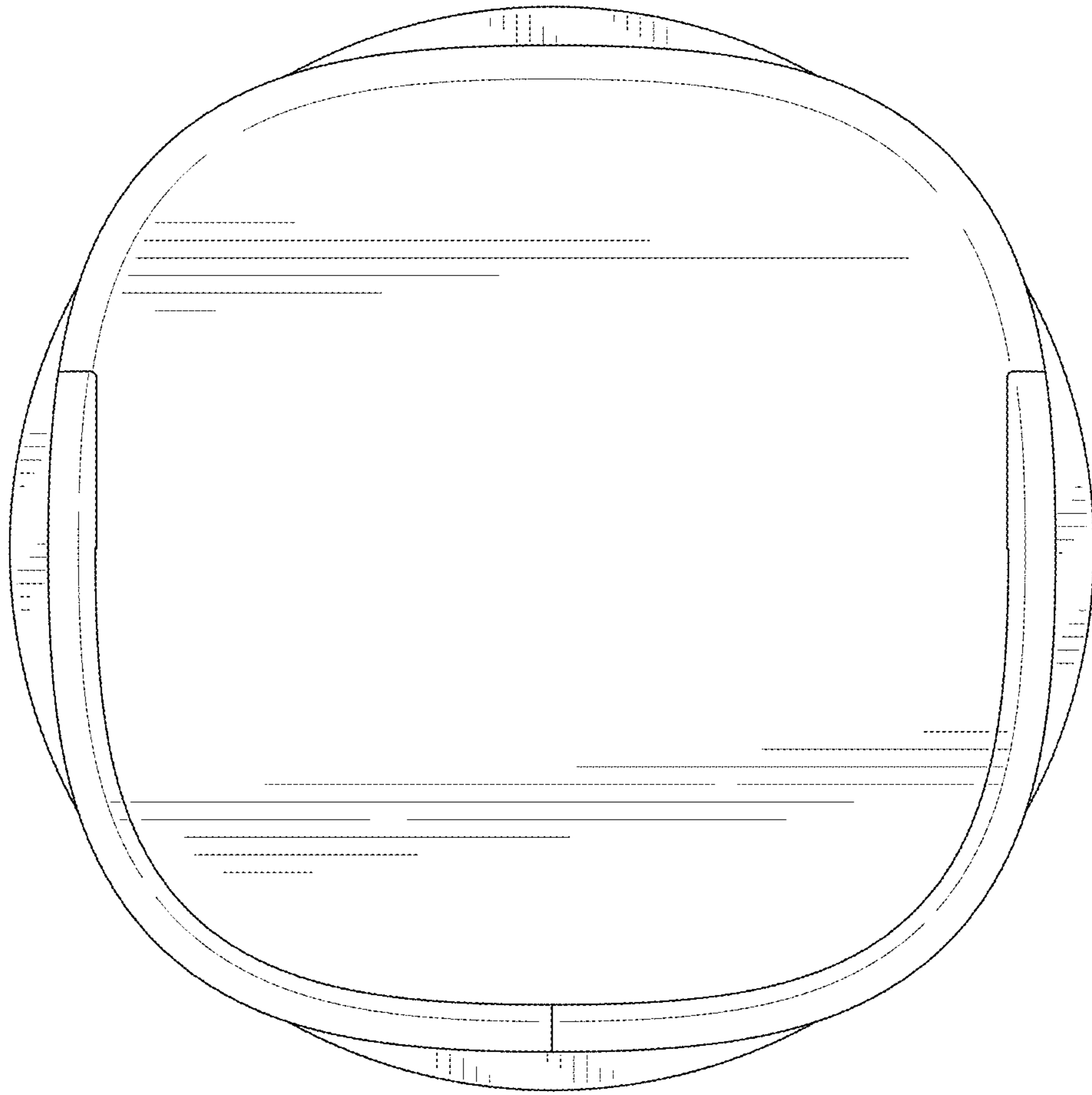

FIG. 7