



US00D916986S

(12) **United States Design Patent** (10) **Patent No.:** **US D916,986 S**
Ribbens et al. (45) **Date of Patent:** **** Apr. 20, 2021**

(54) **TOTEM TOY SET**

(71) Applicant: **SMART N.V.**, Kontich (BE)
(72) Inventors: **Emma Ribbens**, Antwerp (BE); **Tom Buelens**, Borgerhout (BE)

(73) Assignee: **SMART N.V.**, Kontich (BE)

(**) Term: **15 Years**

(21) Appl. No.: **29/699,909**

(22) Filed: **Jul. 30, 2019**

(30) **Foreign Application Priority Data**

Jan. 30, 2019 (EM) 006125597-0002

Jan. 30, 2019 (EM) 006125597-0003

(51) **LOC (13) Cl.** **21-01**

(52) **U.S. Cl.**
USPC **D21/493**; D21/506; D21/471

(58) **Field of Classification Search**
USPC D21/398, 468, 471, 475, 479, 483, 484,
D21/493, 494, 496, 658; D11/133, 157

(Continued)

(56) **References Cited**

U.S. PATENT DOCUMENTS

D272,454 S * 1/1984 Boudreaux D21/471

D300,542 S * 4/1989 Thomson D21/471

(Continued)

OTHER PUBLICATIONS

Fisher-Price Wooden Toys Totem Pole Pals, reviewed on Amazon Mar. 16, 2017 [online], [site visited Aug. 28, 2020]. Available from Internet: <URL:https://www.amazon.com/Fisher-Price-Wooden-Toys-Totem-Pole/dp/B01D8J2VBK/ref=cm_cr_ar_p_d_product_top?ie=UTF8> (Year: 2017).*

(Continued)

Primary Examiner — Cynthia M. Chin

(74) *Attorney, Agent, or Firm* — Hodgson Russ LLP

(57) **CLAIM**

The ornamental design for a totem toy set, as shown and described.

DESCRIPTION

FIG. 1 is a perspective view of a totem toy set;
FIG. 2 is a perspective view of a first piece thereof;
FIG. 3 is a front elevation view thereof;
FIG. 4 is a rear elevation view thereof;
FIG. 5 is a right side elevation view thereof;
FIG. 6 is a left side elevation view thereof;
FIG. 7 is a bottom plan view thereof;
FIG. 8 is a top plan view thereof;
FIG. 9 is a perspective view of a second piece of the totem toy set;
FIG. 10 is a front elevation view thereof;
FIG. 11 is a rear elevation view thereof;
FIG. 12 is a right side elevation view thereof;
FIG. 13 is a left side elevation view thereof;
FIG. 14 is a bottom plan view thereof;
FIG. 15 is a top plan view thereof;
FIG. 16 is a perspective view of a third piece of the totem toy set;
FIG. 17 is a front elevation view thereof;
FIG. 18 is a rear elevation view thereof;
FIG. 19 is a right side elevation view thereof;
FIG. 20 is a left side elevation view thereof;
FIG. 21 is a bottom plan view thereof;
FIG. 22 is a top plan view thereof;
FIG. 23 is a perspective view of a fourth piece of the totem toy set;
FIG. 24 is a front elevation view thereof;
FIG. 25 is a rear elevation view thereof;
FIG. 26 is a right side elevation view thereof;
FIG. 27 is a left side elevation view thereof;
FIG. 28 is a bottom plan view thereof;
FIG. 29 is a top plan view thereof;
FIG. 30 is a perspective view of a fifth piece of the totem toy set;
FIG. 31 is a front elevation view thereof;
FIG. 32 is a rear elevation view thereof;
FIG. 33 is a right side elevation view thereof;

(Continued)

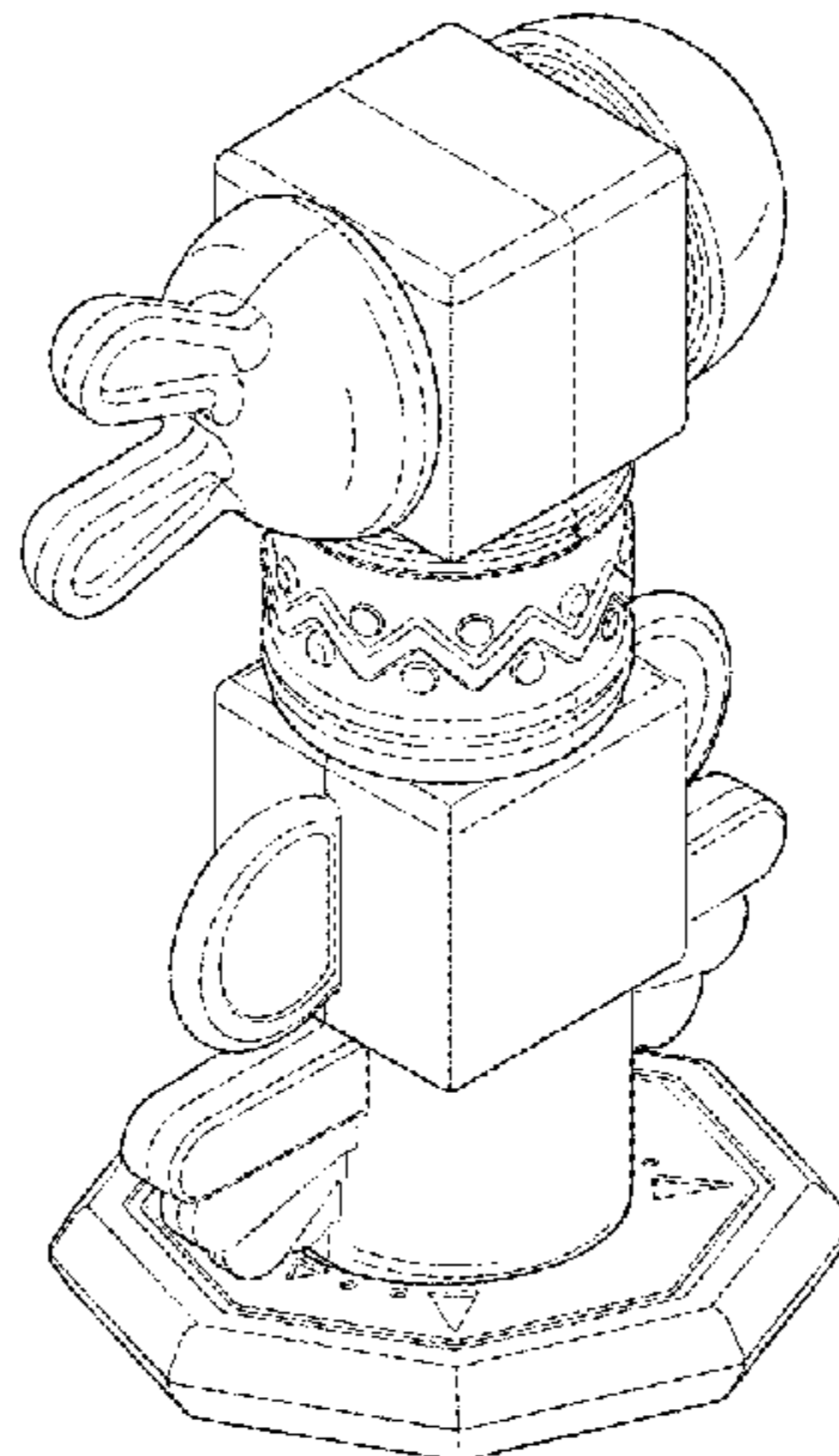

FIG. 34 is a left side elevation view thereof;
 FIG. 35 is a bottom plan view thereof;
 FIG. 36 is a top plan view thereof;
 FIG. 37 is a perspective view of a sixth piece of the totem toy set;
 FIG. 38 is a front elevation view thereof;
 FIG. 39 is a rear elevation view thereof;
 FIG. 40 is a right side elevation view thereof;
 FIG. 41 is a left side elevation view thereof;
 FIG. 42 is a bottom plan view thereof;
 FIG. 43 is a top plan view thereof;
 FIG. 44 is a perspective view of a seventh piece of the totem toy set;
 FIG. 45 is a front elevation view thereof;
 FIG. 46 is a rear elevation view thereof;
 FIG. 47 is a right side elevation view thereof;
 FIG. 48 is a left side elevation view thereof;
 FIG. 49 is a bottom plan view thereof;
 FIG. 50 is a top plan view thereof;
 FIG. 51 is a perspective view of an eighth piece of the totem toy set;
 FIG. 52 is a front elevation view thereof;
 FIG. 53 is a rear elevation view thereof;
 FIG. 54 is a right side elevation view thereof;
 FIG. 55 is a left side elevation view thereof;
 FIG. 56 is a bottom plan view thereof; and,
 FIG. 57 is a top plan view thereof.
 The broken lines are for the purpose of illustrating portions of the article that form no part of the claimed design.

1 Claim, 33 Drawing Sheets

(58) **Field of Classification Search**

CPC A63H 33/04; A63H 33/06
 See application file for complete search history.

(56) **References Cited**

U.S. PATENT DOCUMENTS

| | | | | | | |
|--------------|----|---|---------|------------------|-------|----------------------|
| D395,682 | S | * | 6/1998 | Bartholdy | | D21/484 |
| D403,721 | S | * | 1/1999 | Bean | | D21/499 |
| D405,121 | S | * | 2/1999 | Pardorf | | D21/488 |
| D434,812 | S | * | 12/2000 | Lehn Høeg | | D21/487 |
| D469,478 | S | * | 1/2003 | Manville | | D21/488 |
| D482,737 | S | * | 11/2003 | Chaudoreille | | D21/493 |
| D615,135 | S | * | 5/2010 | Thorsen | | D21/487 |
| D709,135 | S | * | 7/2014 | Haut | | D21/406 |
| D865,075 | S | * | 10/2019 | Mangnall-Schwarz | | D21/493 |
| 2009/0170401 | A1 | * | 7/2009 | Stubenfohl | | A63H 3/16 446/378 |
| 2018/0250604 | A1 | * | 9/2018 | Keesee, Jr. | | A63H 9/00 |
| 2019/0091590 | A1 | * | 3/2019 | Hazan | | A63H 33/046 |

OTHER PUBLICATIONS

SmartMax My First Totem STEM Magnetic Discovery Building Game reviewed on Amazon Jul. 26, 2019 [online], [site visited Aug. 28, 2020]. Available from Internet: <URL:https://www.amazon.com/SmartMax-Magnetic-Discovery-Building-Rattling/dp/B07QXTT2PL/ref=cm-cr_arp_d_product_top?ie=UTF8> (Year: 2019).*

* cited by examiner

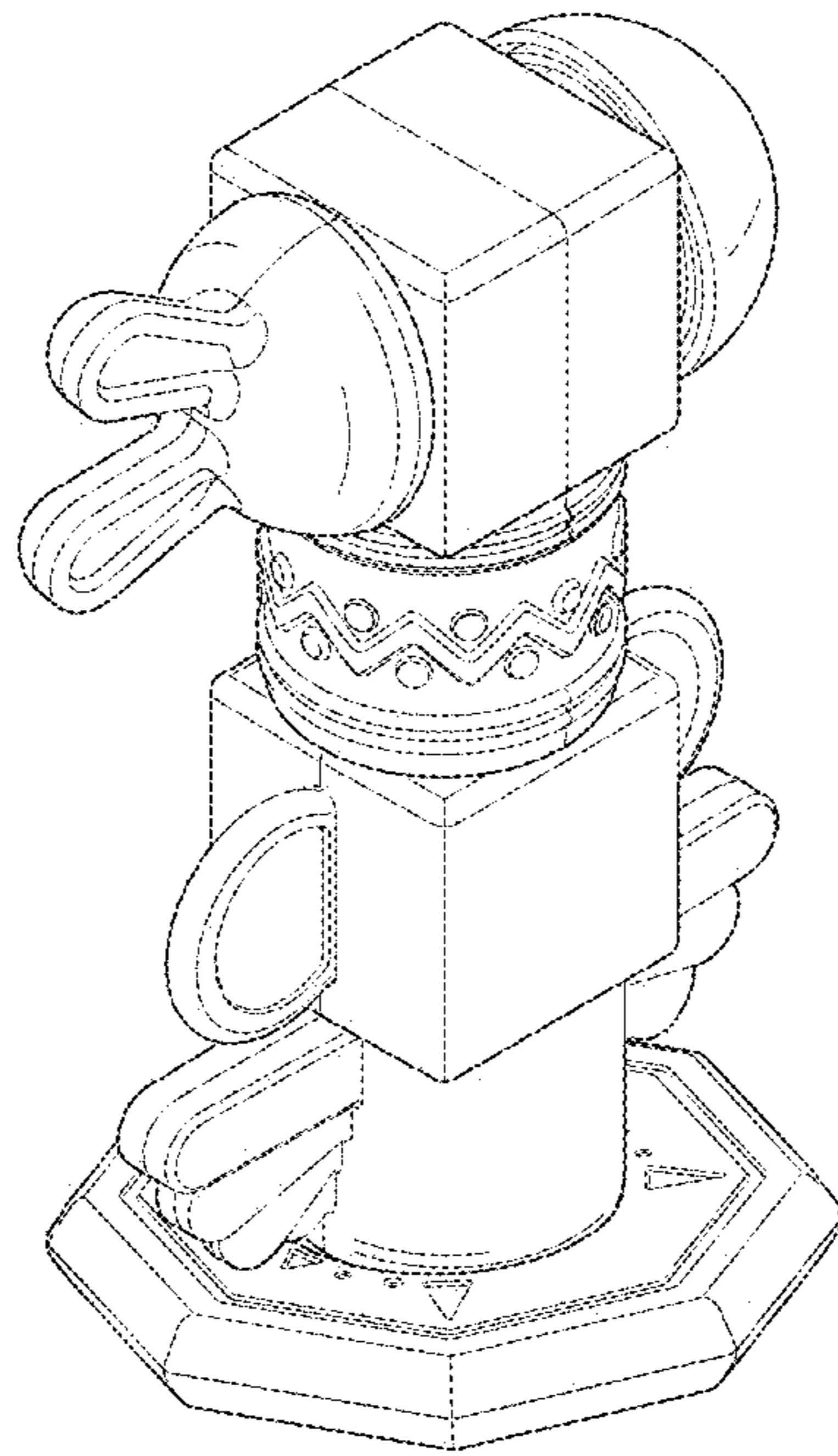

FIG. 1

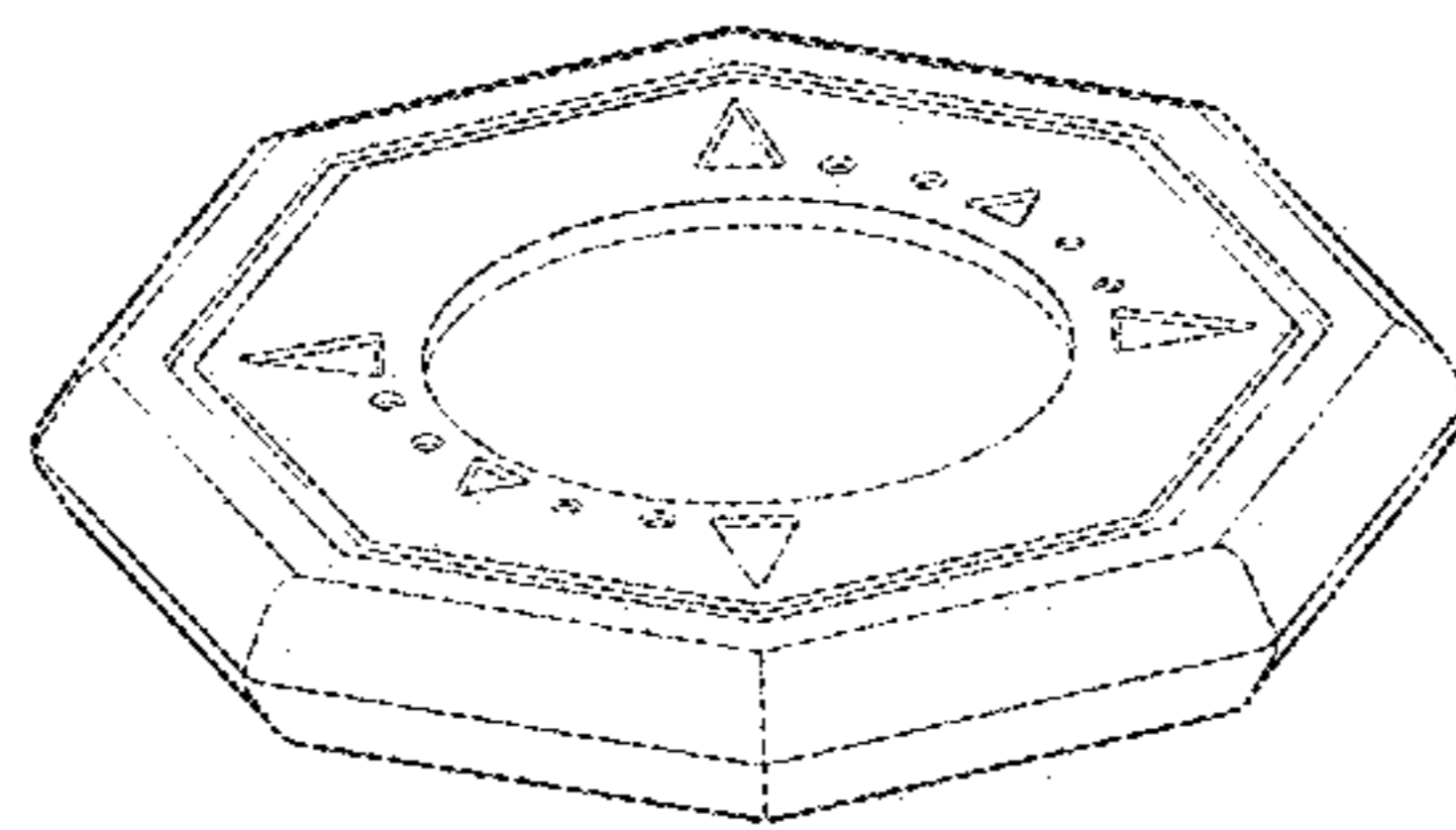

FIG. 2

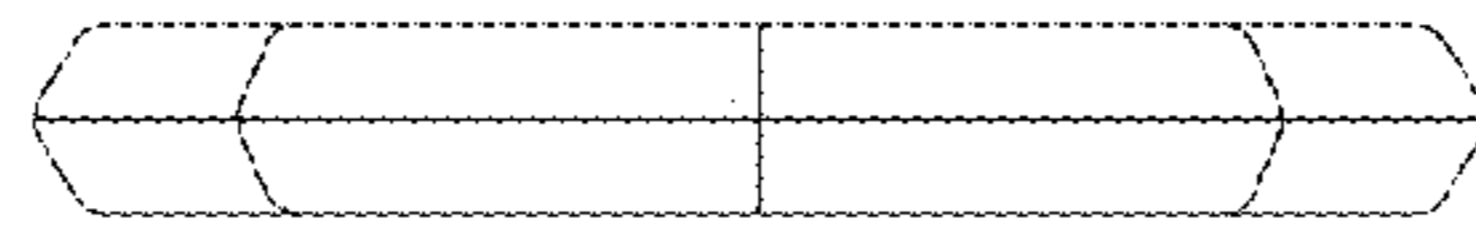

FIG. 3

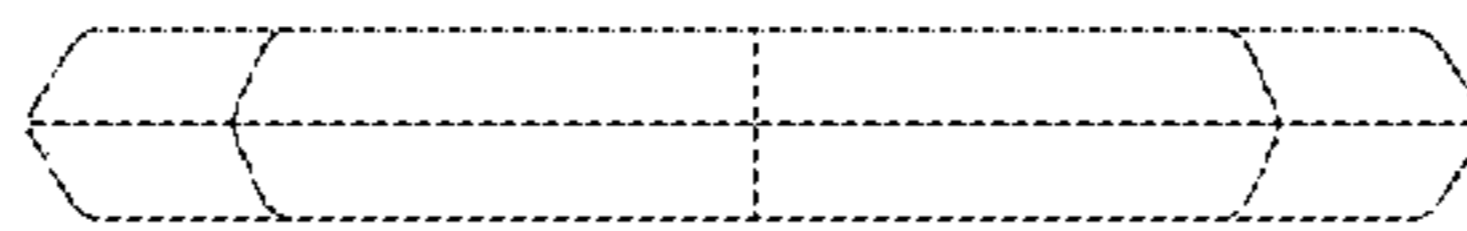

FIG. 4

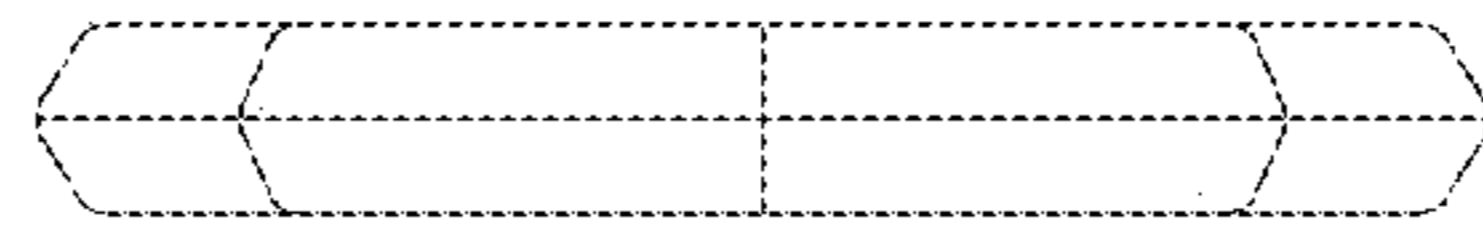

FIG. 5

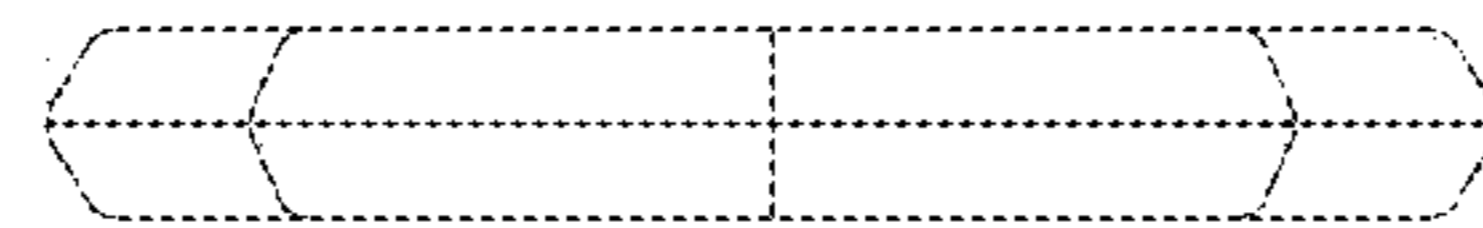

FIG. 6

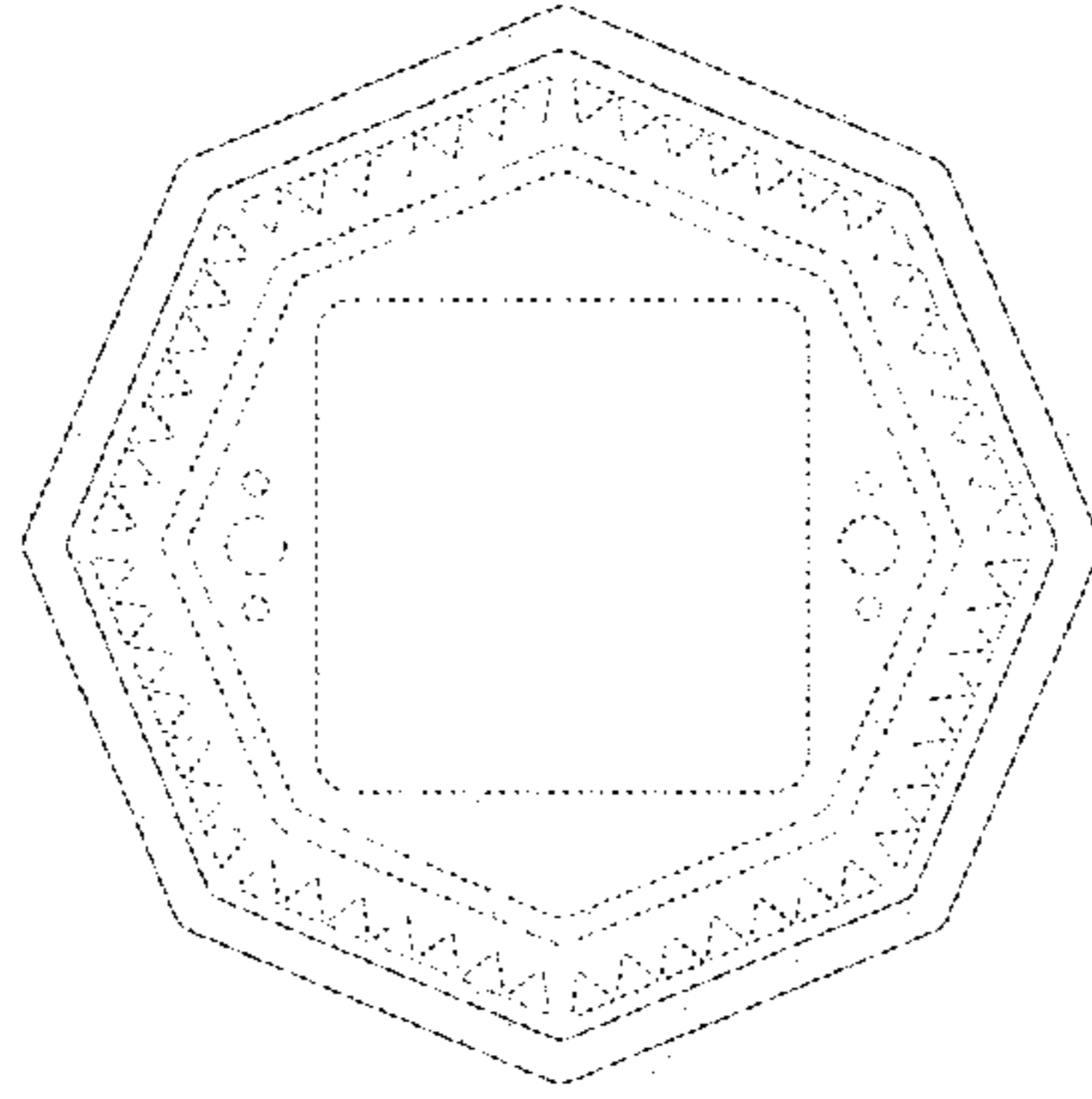

FIG. 7

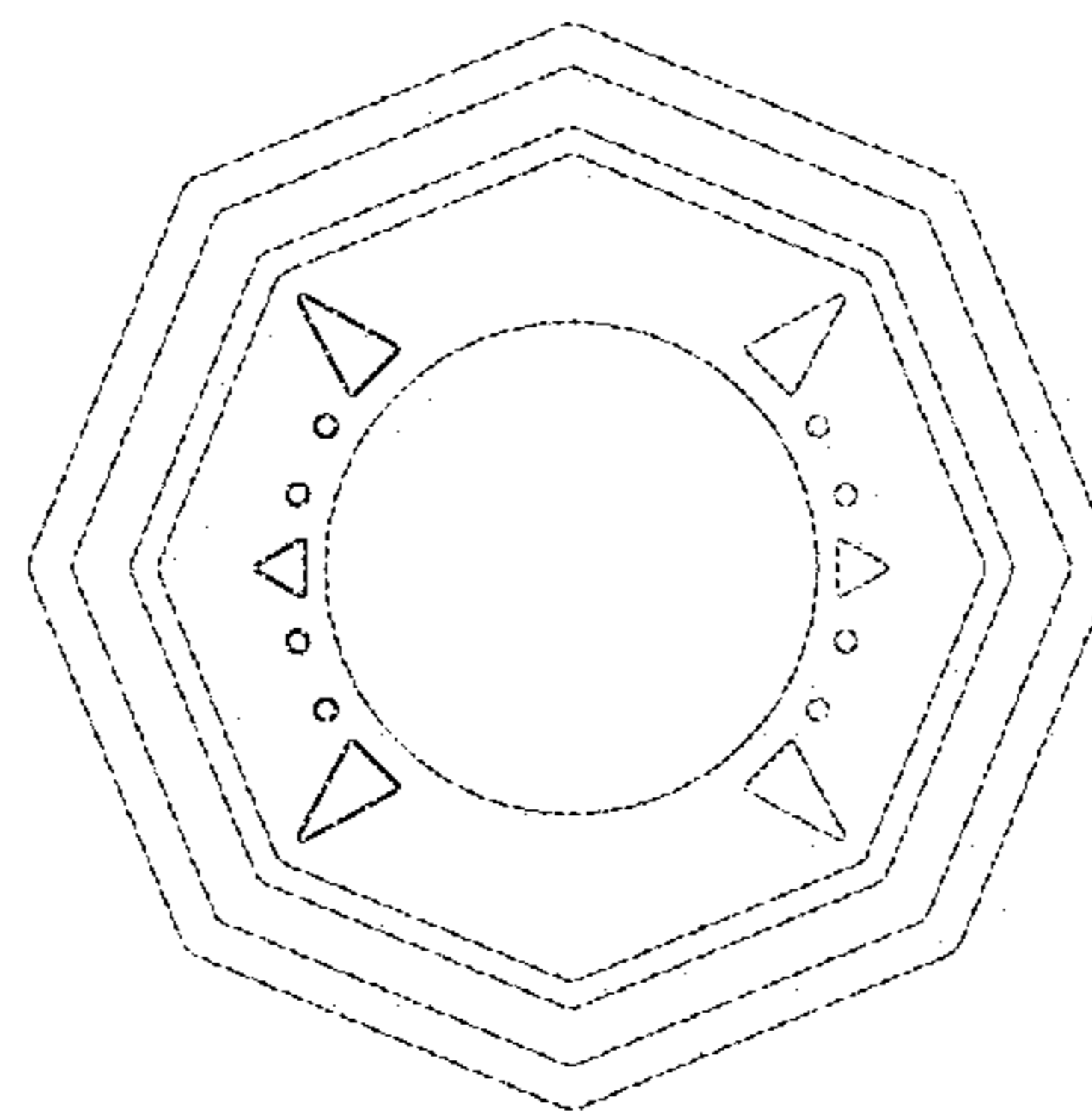

FIG. 8

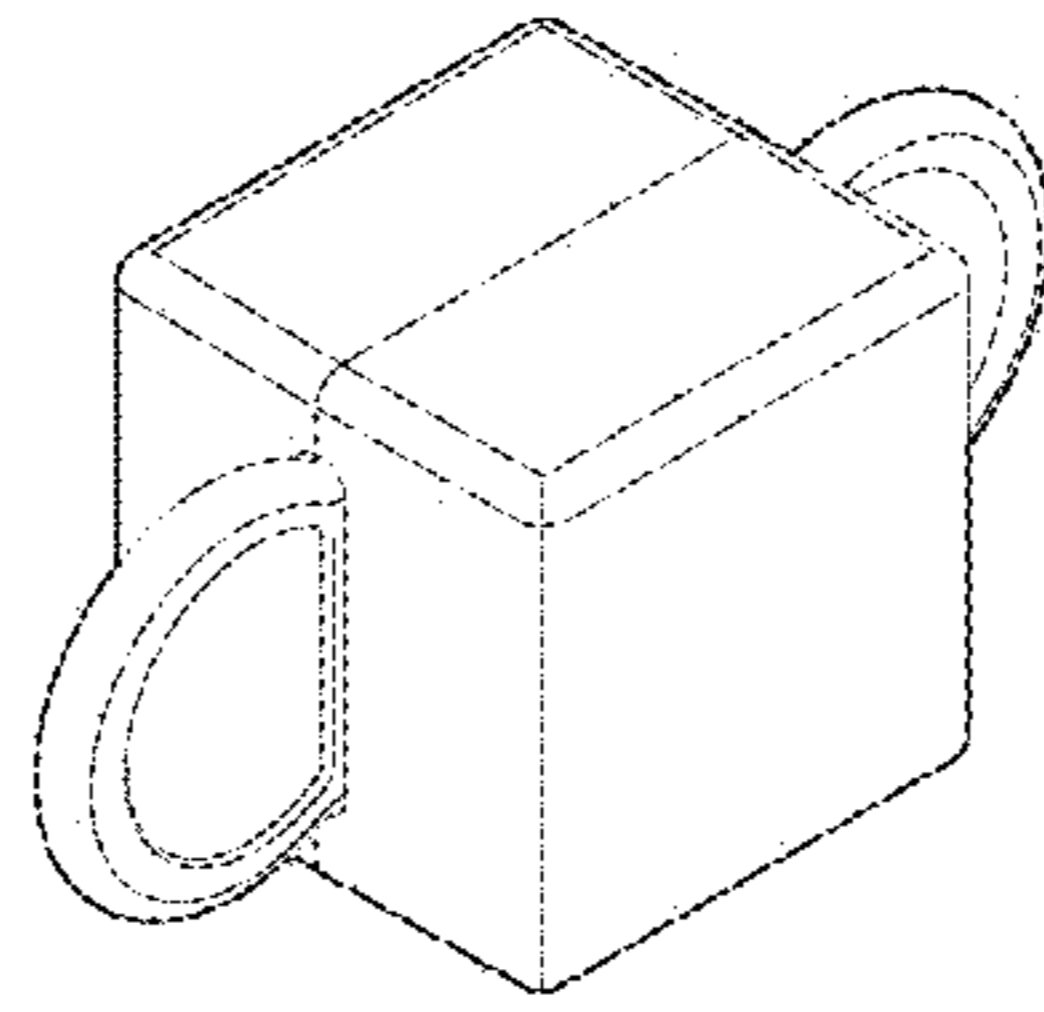

FIG. 9

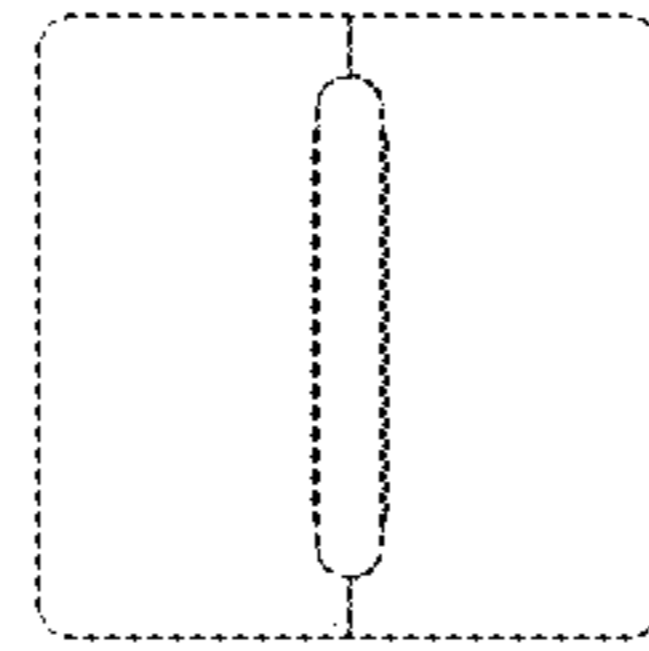

FIG. 10

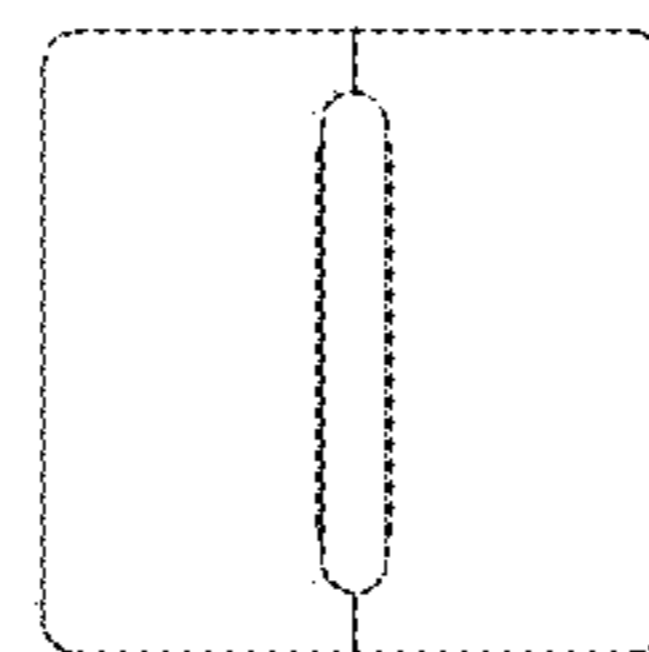

FIG. 11

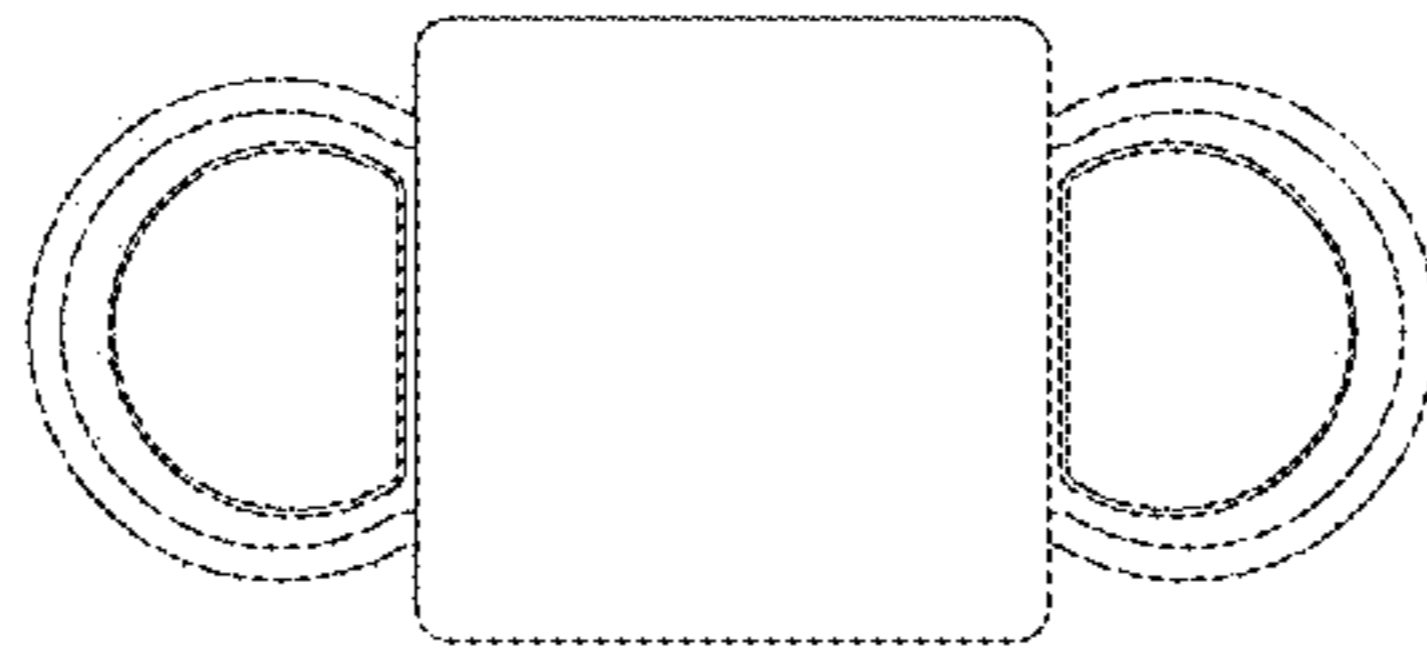

FIG. 12

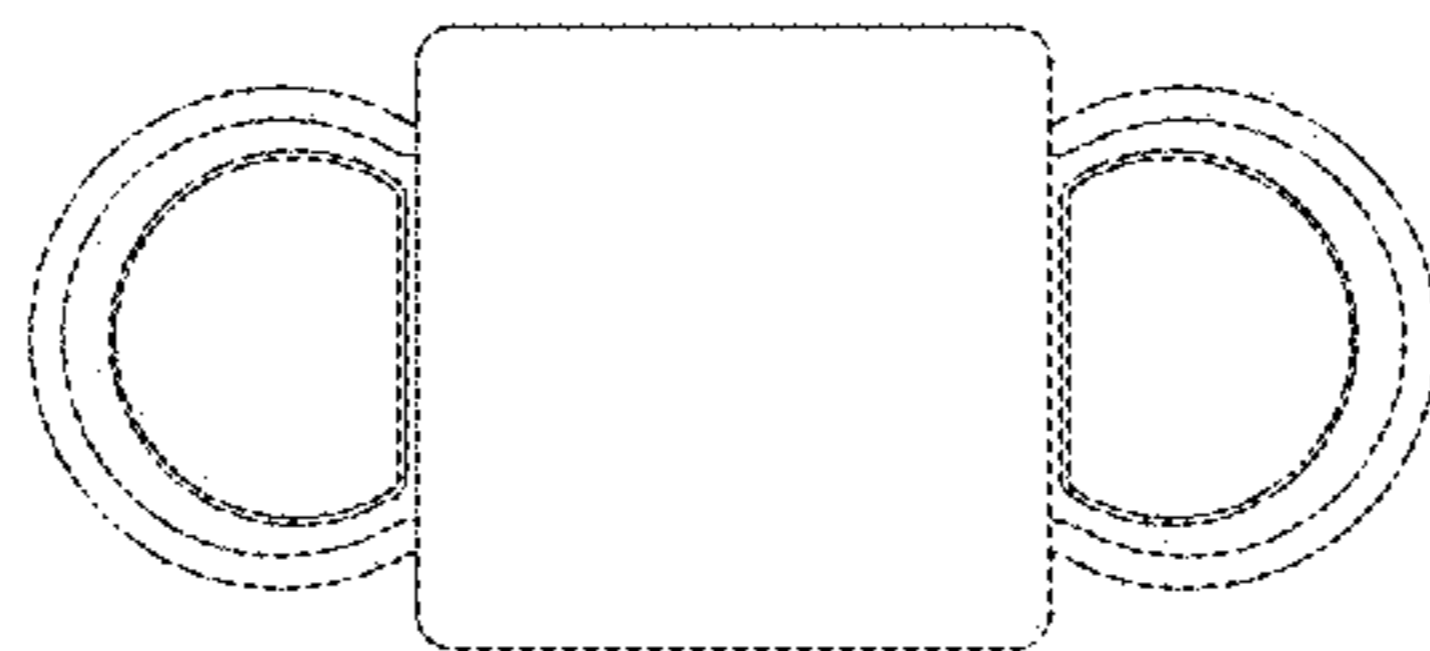

FIG. 13

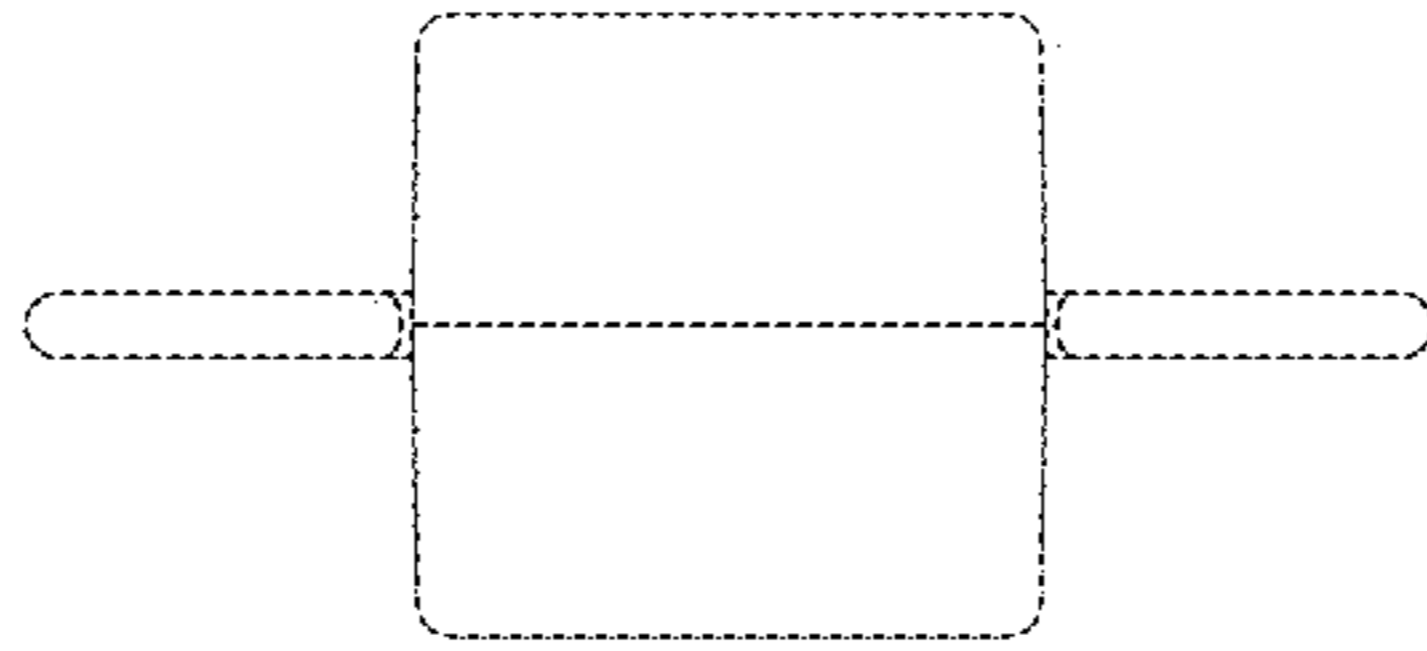

FIG. 14

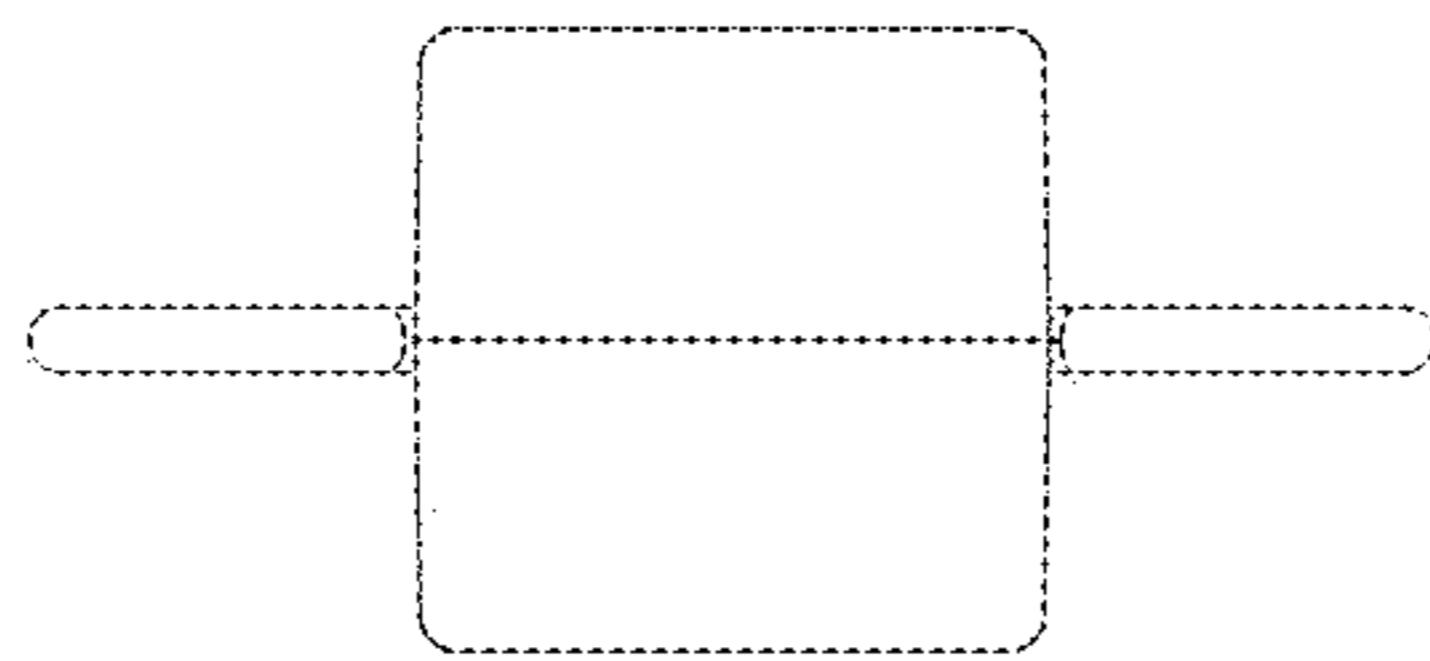

FIG. 15

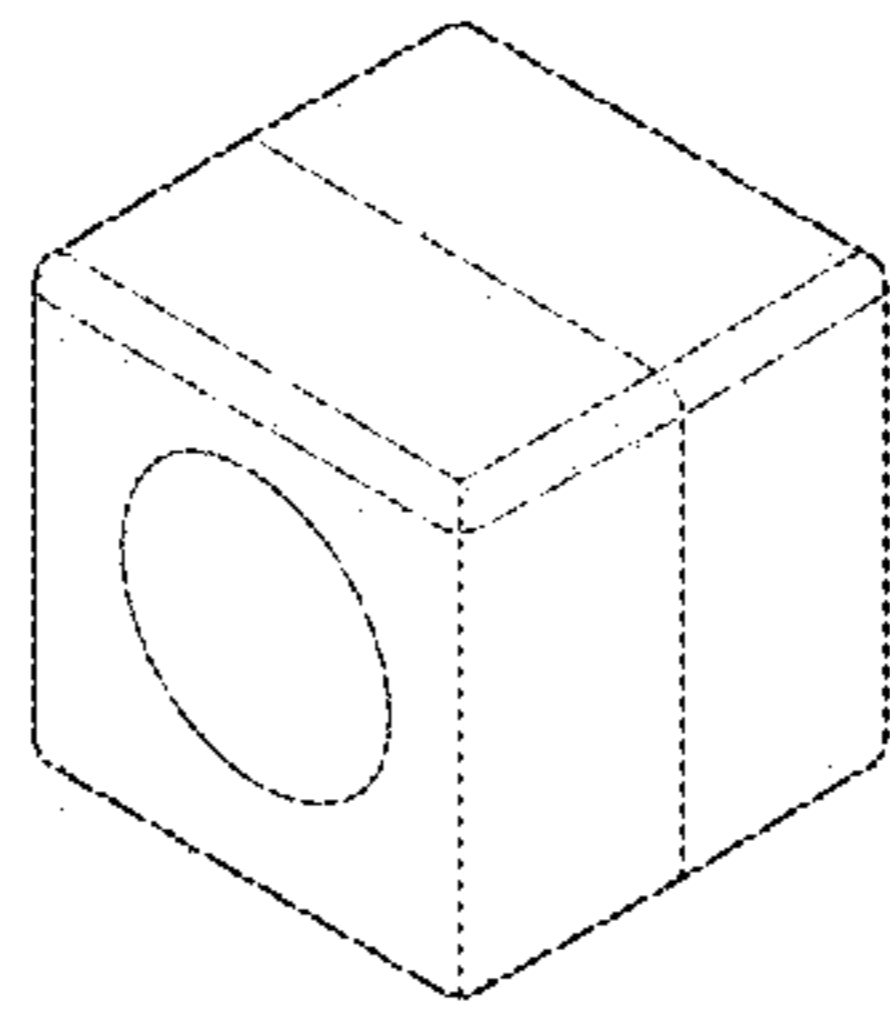

FIG. 16

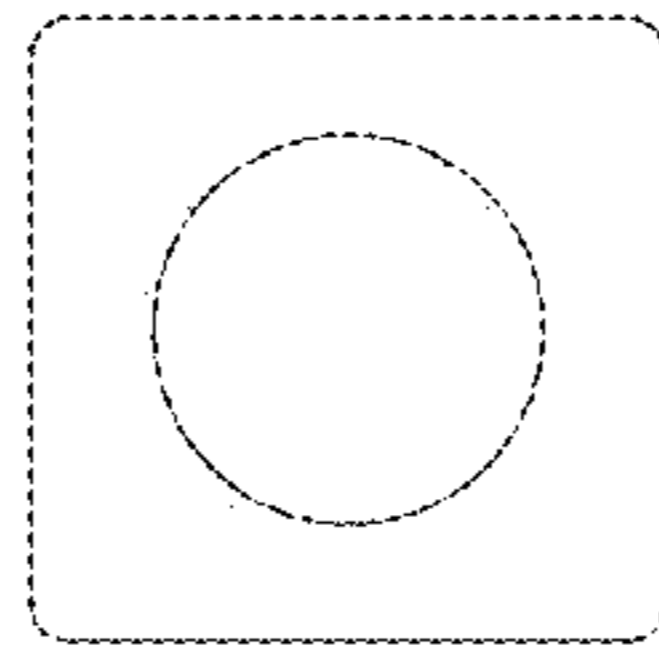

FIG. 17

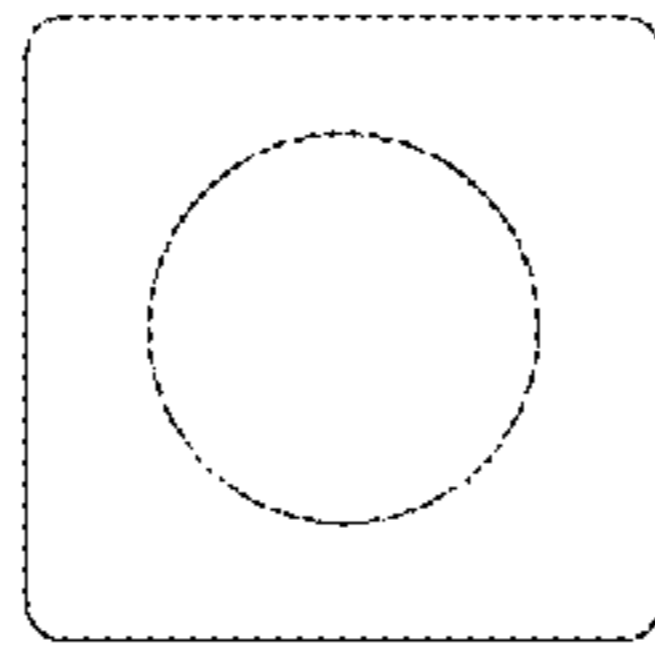

FIG. 18

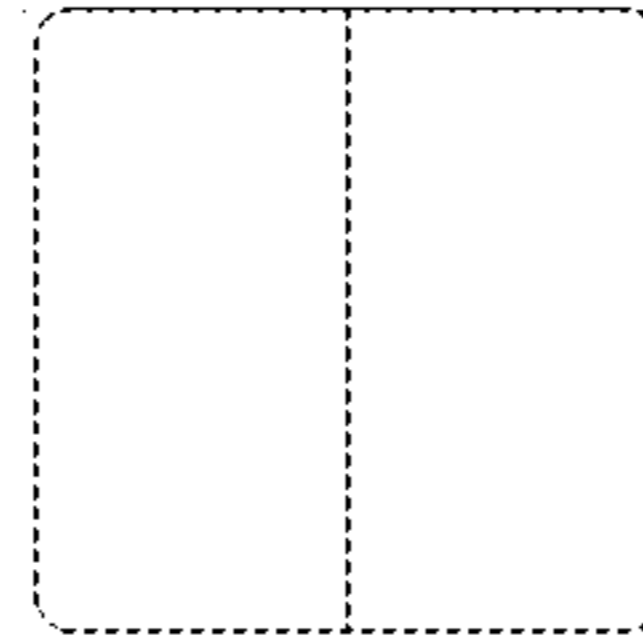

FIG. 19

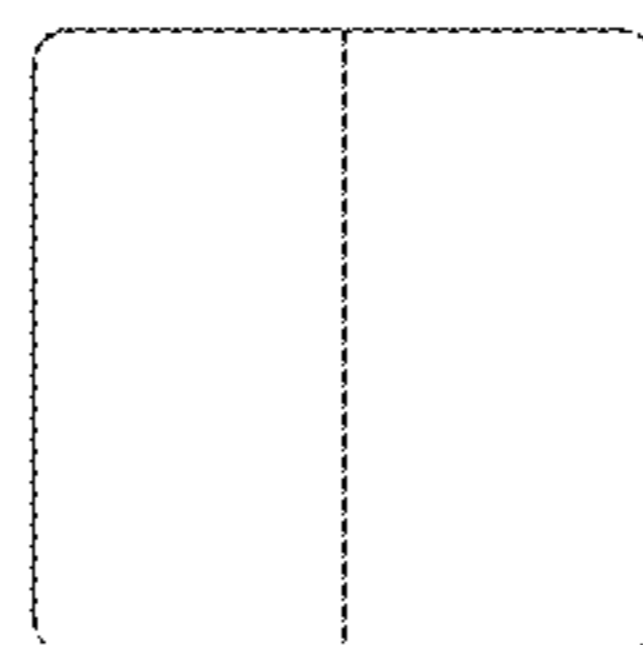

FIG. 20

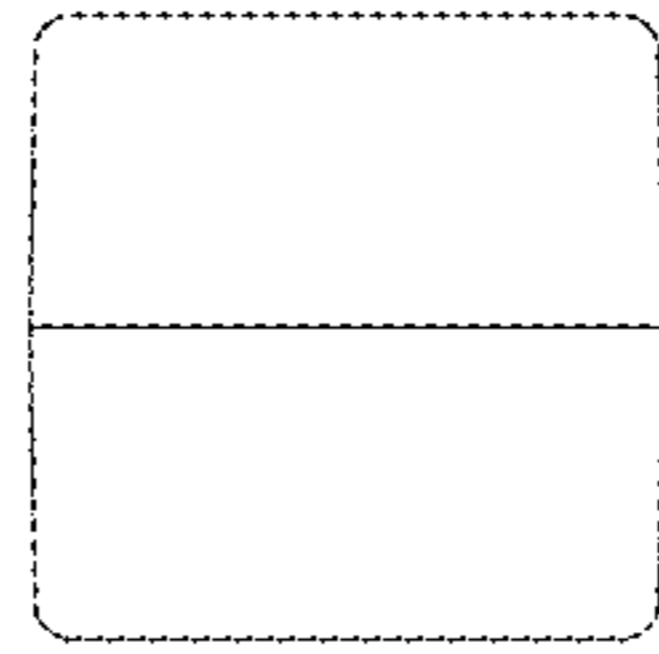

FIG. 21

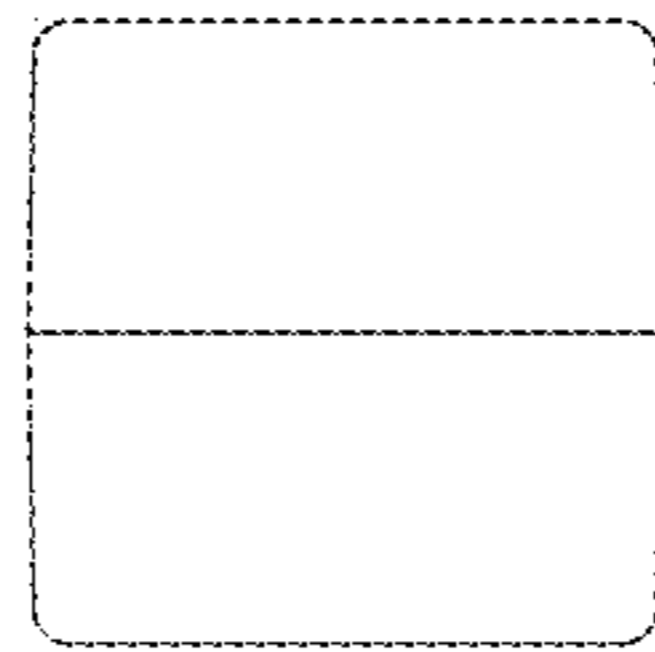

FIG. 22

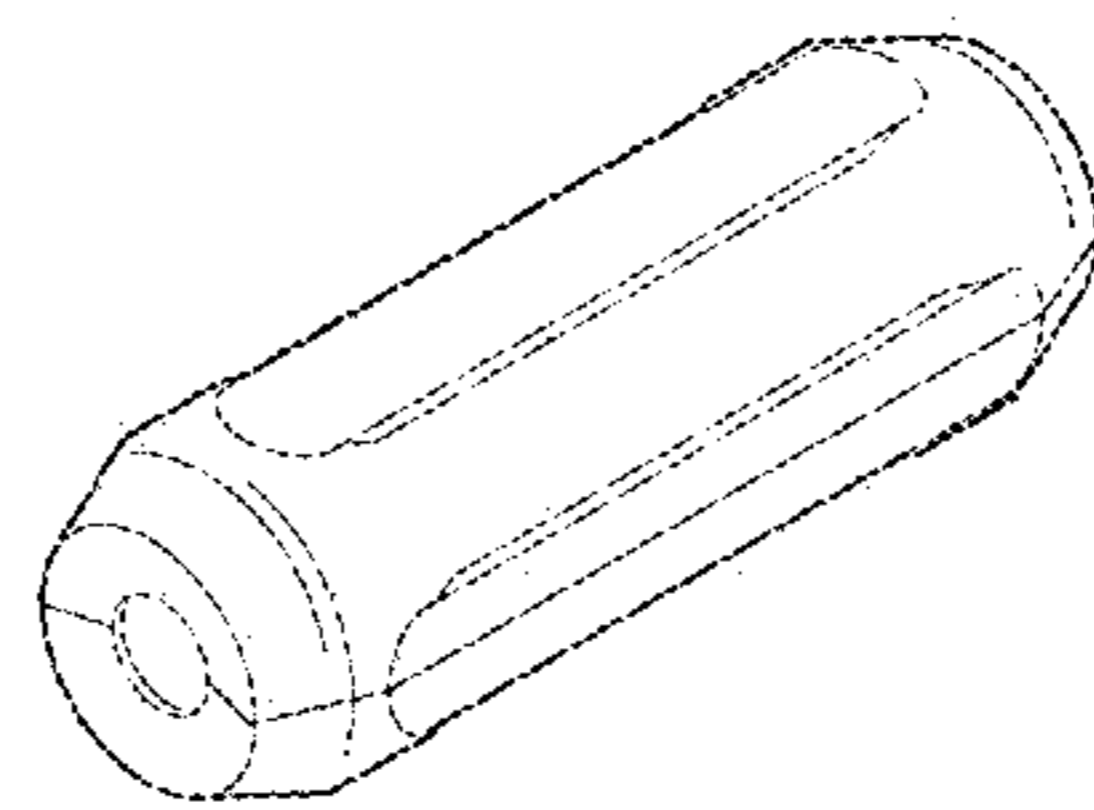

FIG. 23

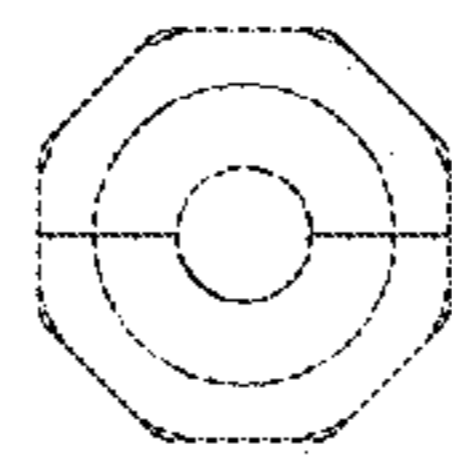

FIG. 24

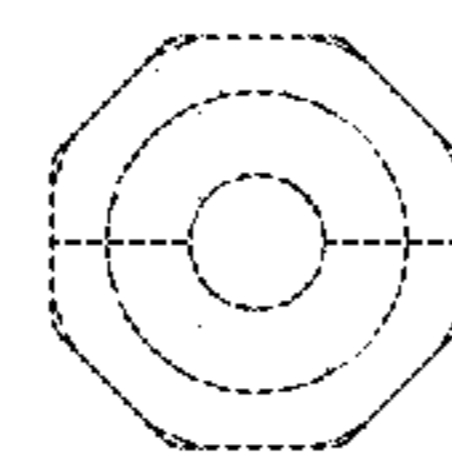

FIG. 25

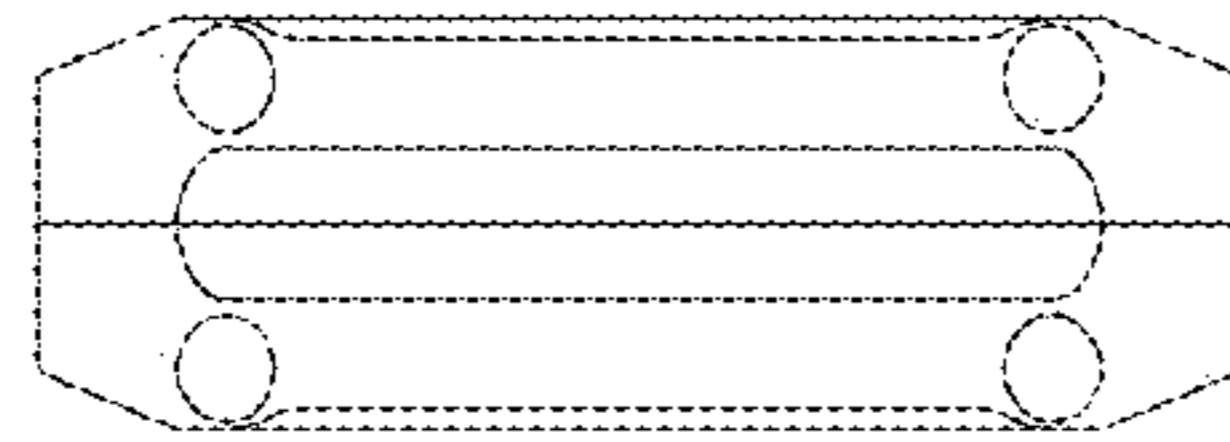

FIG. 26

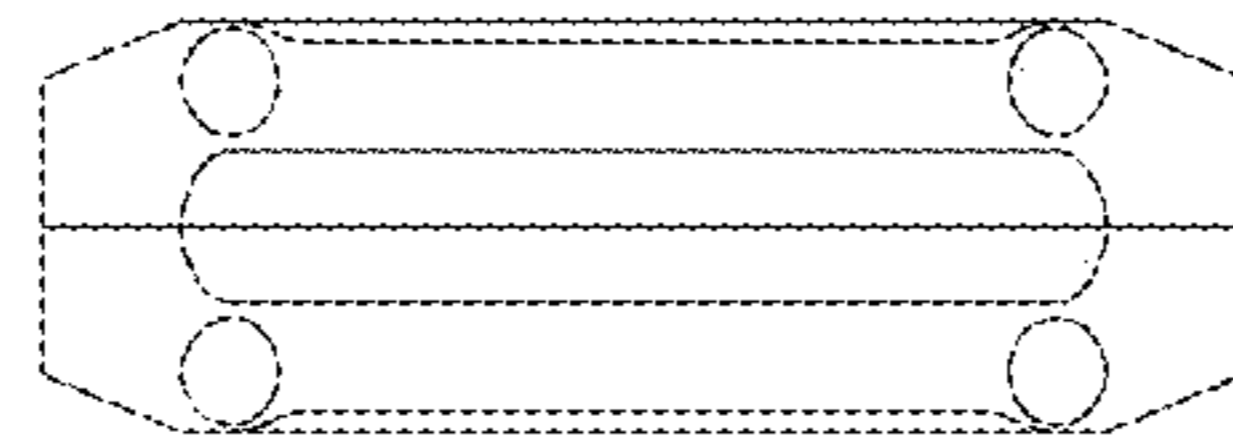

FIG. 27

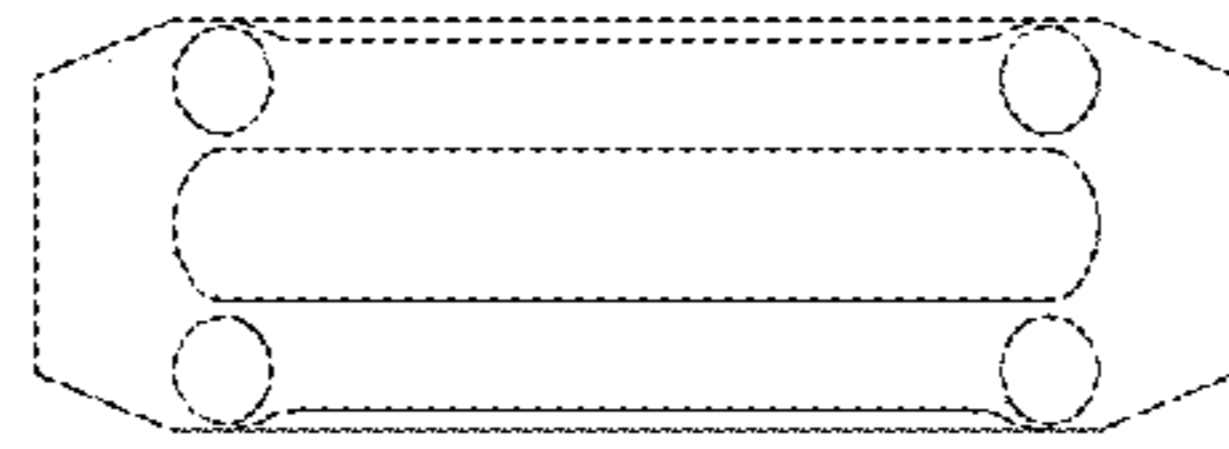

FIG. 28

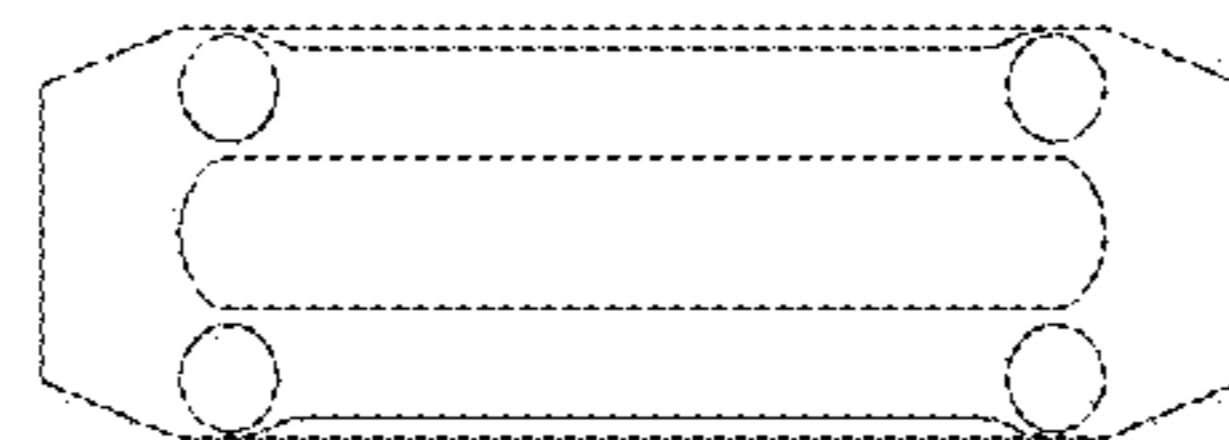

FIG. 29

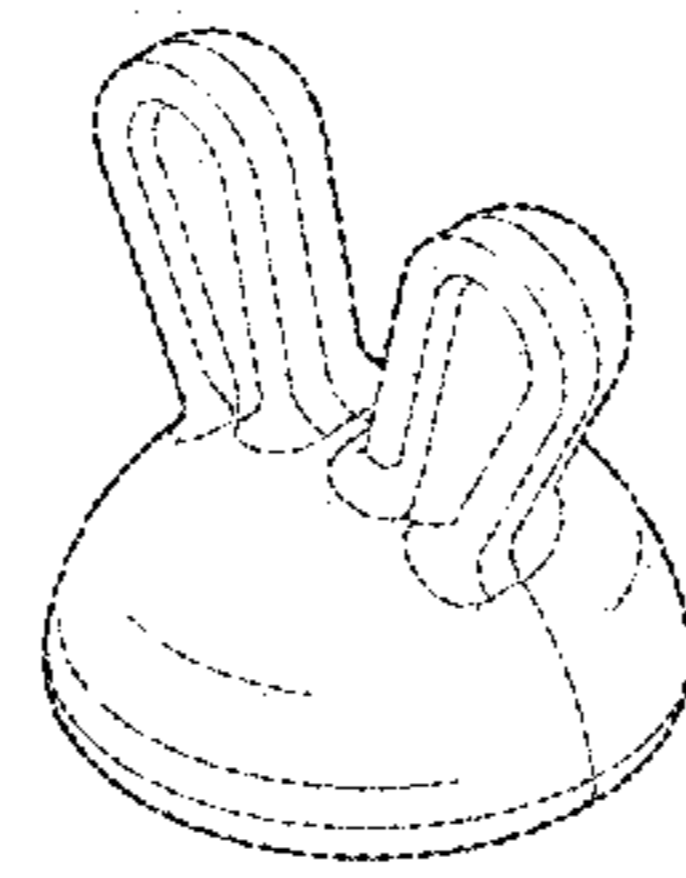

FIG. 30

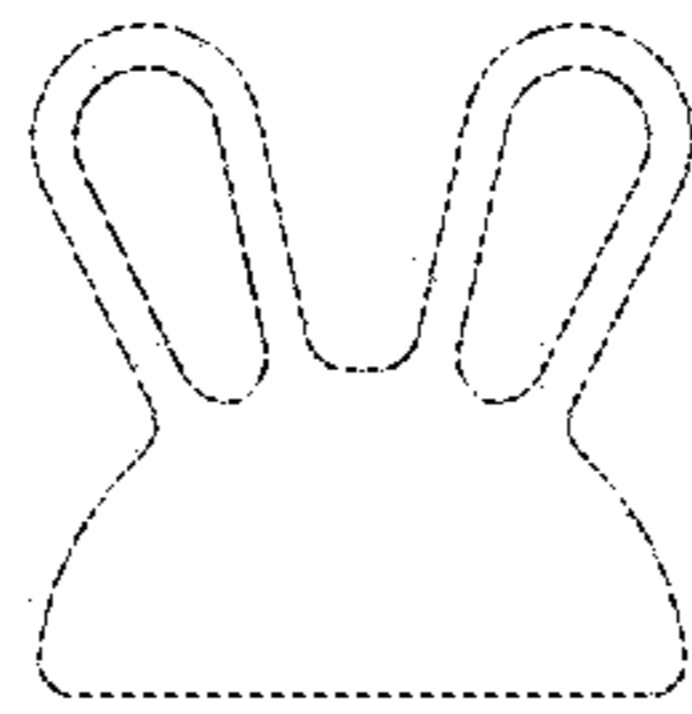

FIG. 31

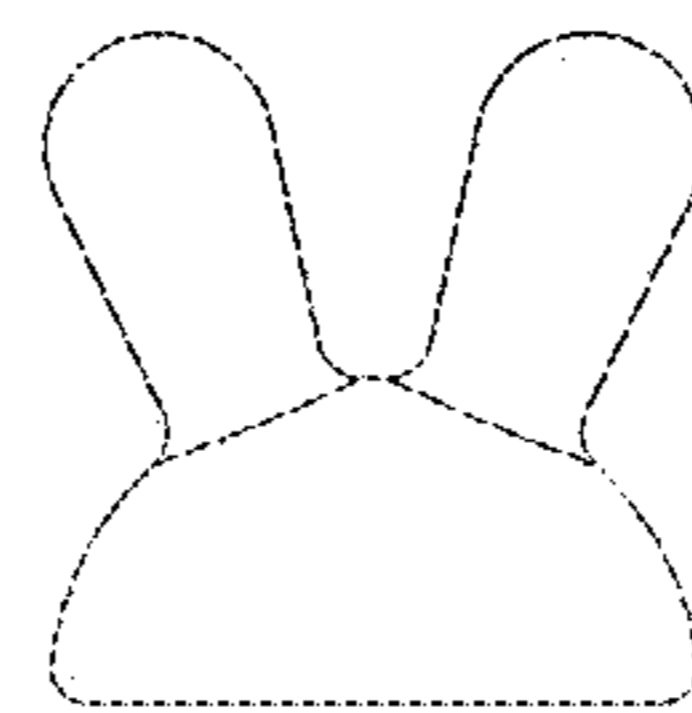

FIG. 32

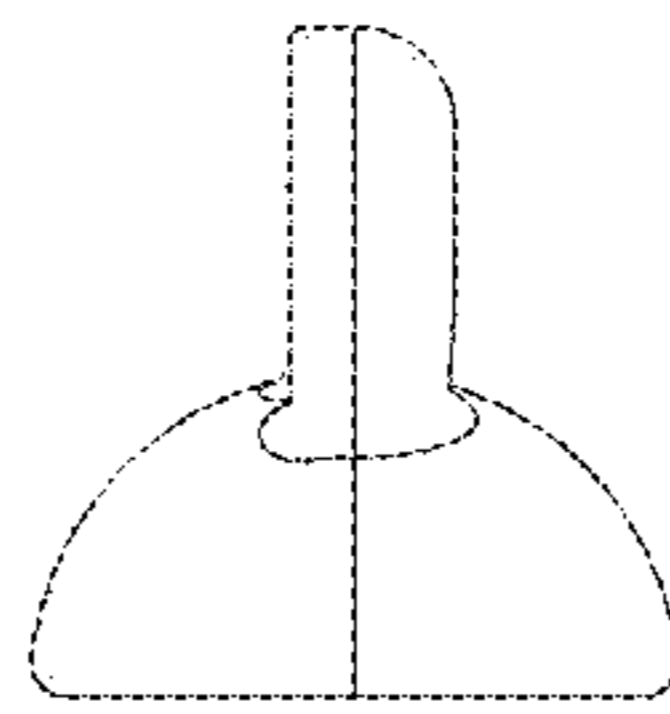

FIG. 33

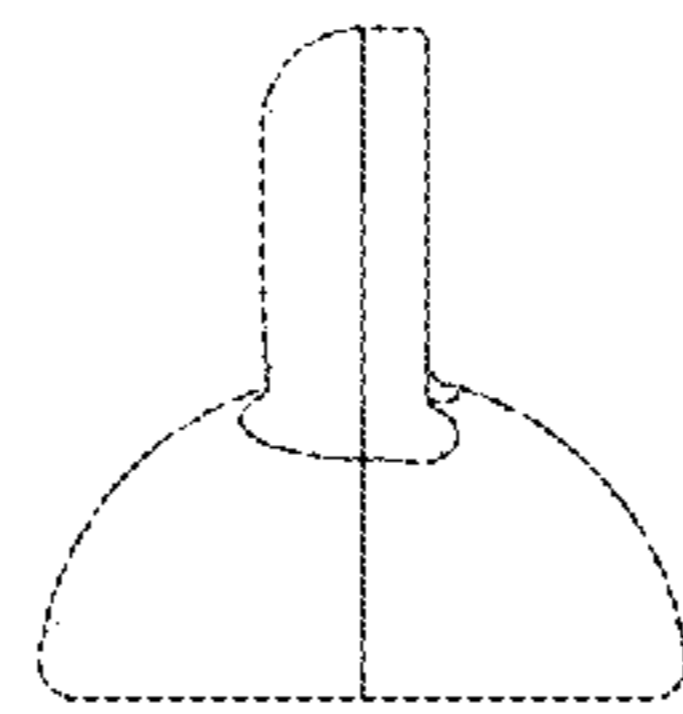

FIG. 34

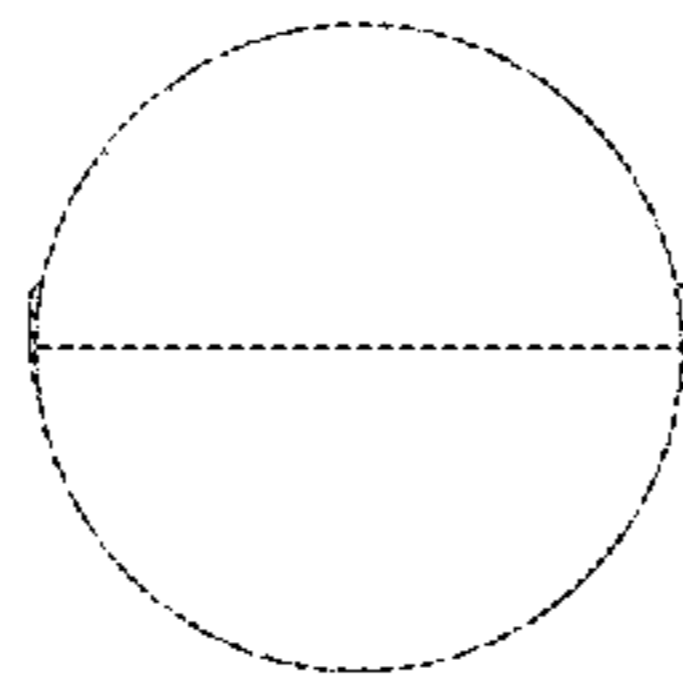

FIG. 35

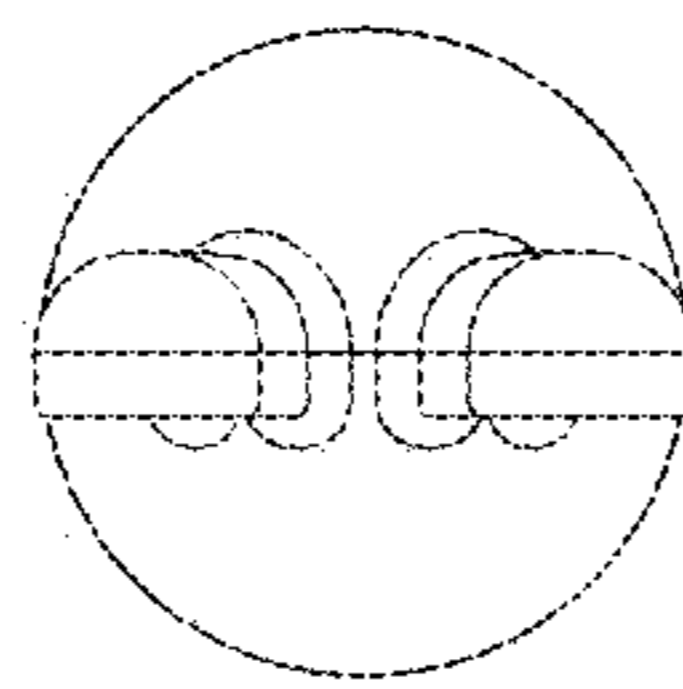

FIG. 36



FIG. 37

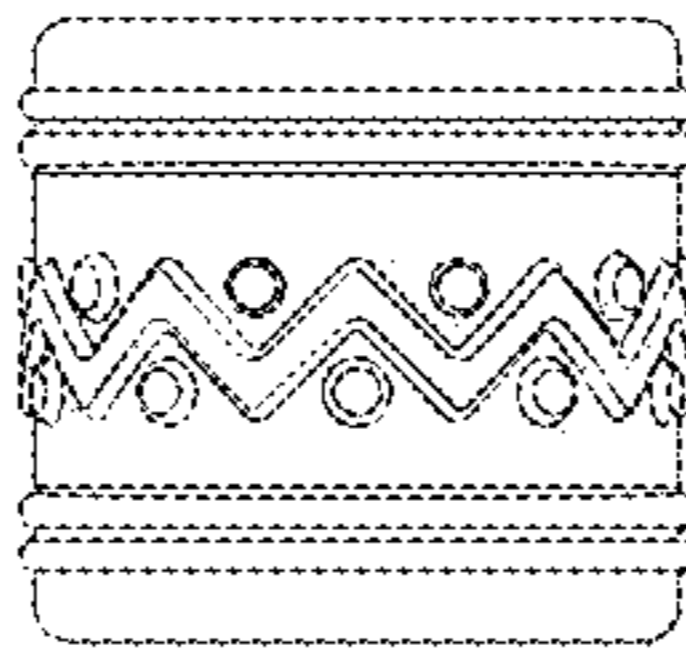

FIG. 38

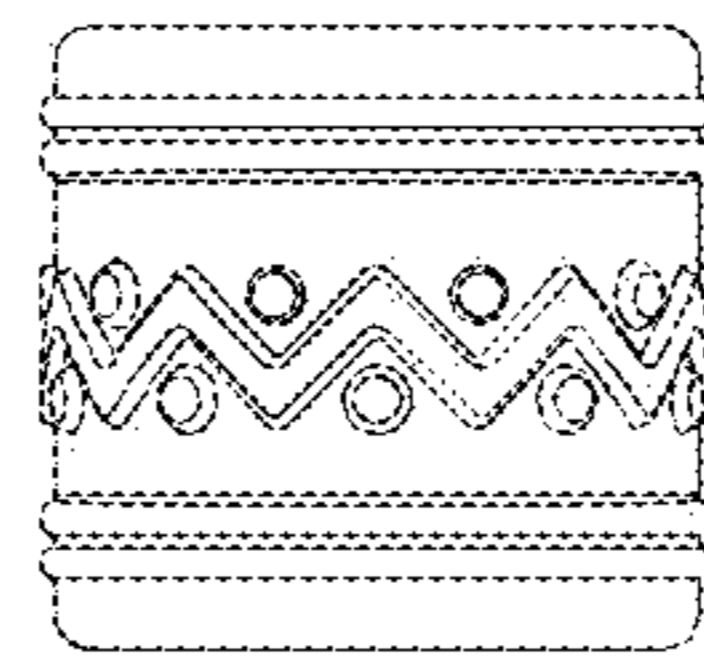

FIG. 39

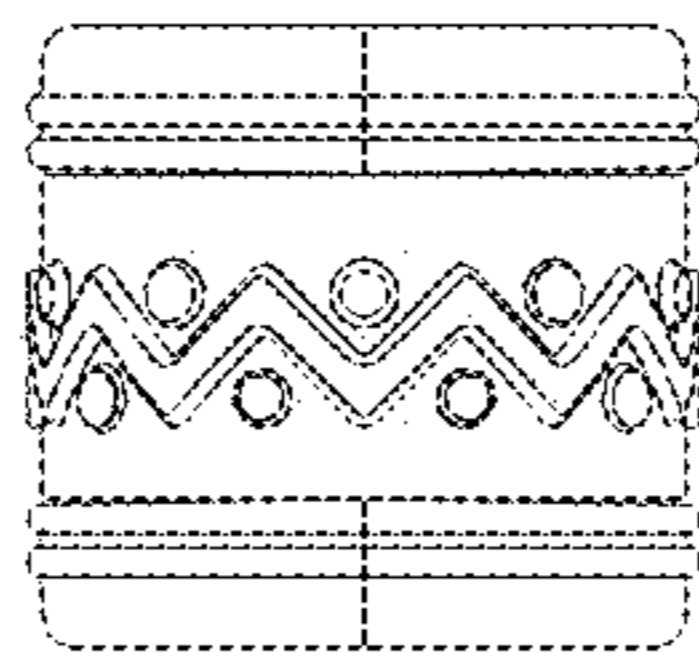

FIG. 40

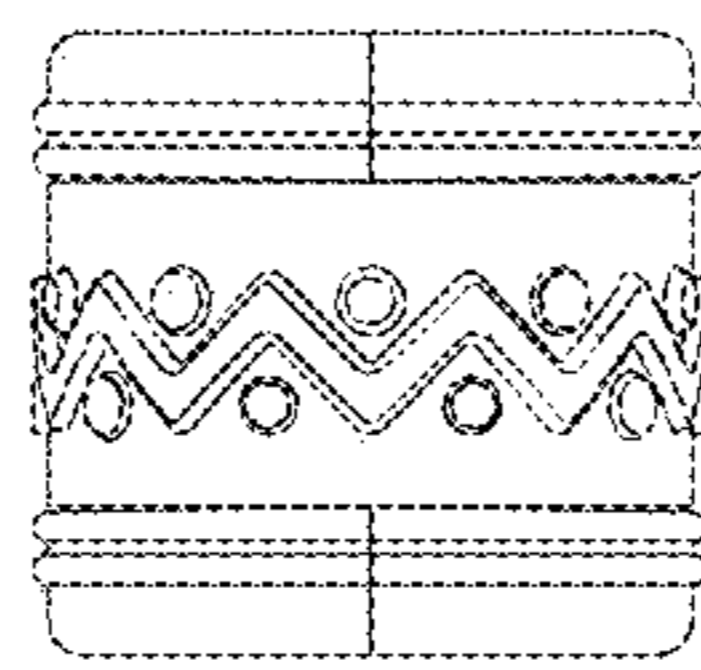

FIG. 41

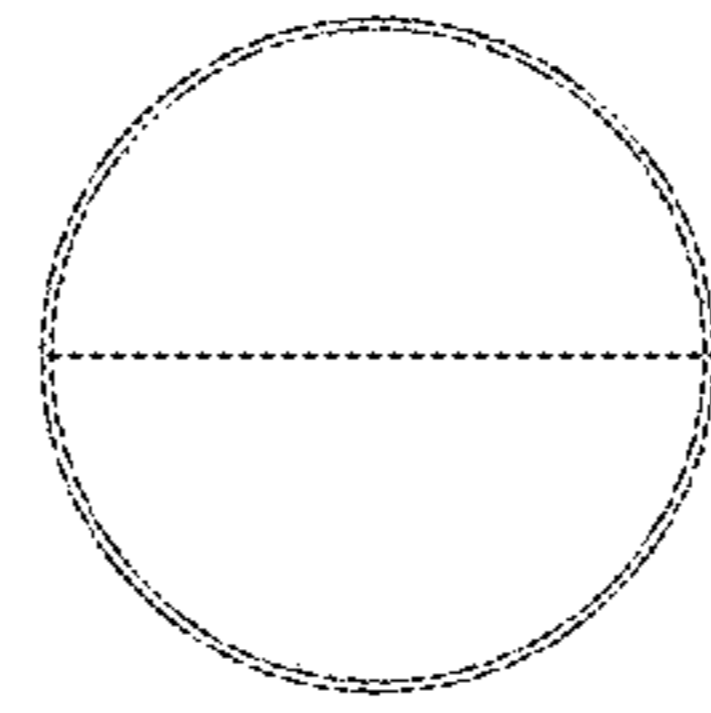

FIG. 42

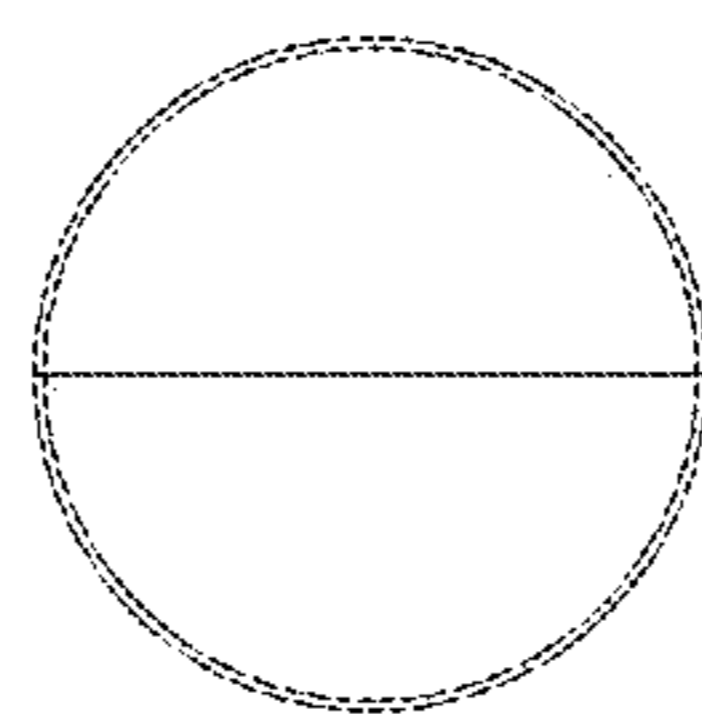

FIG. 43

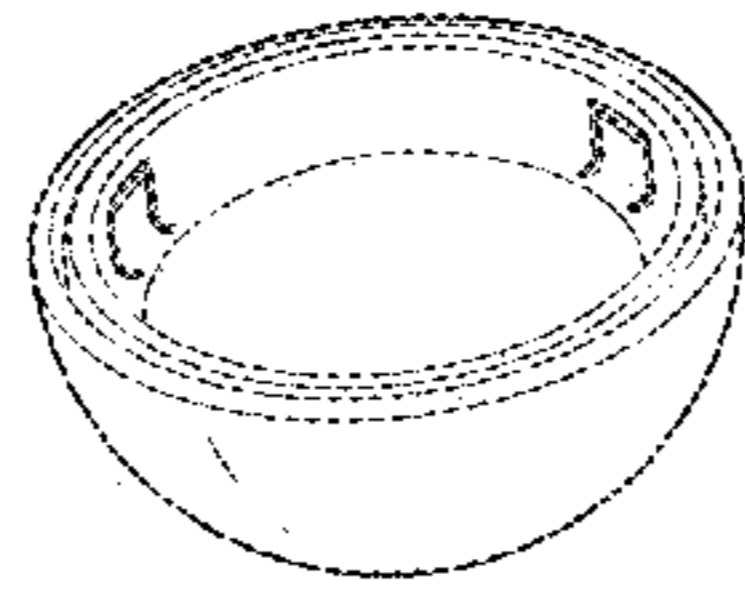

FIG. 44

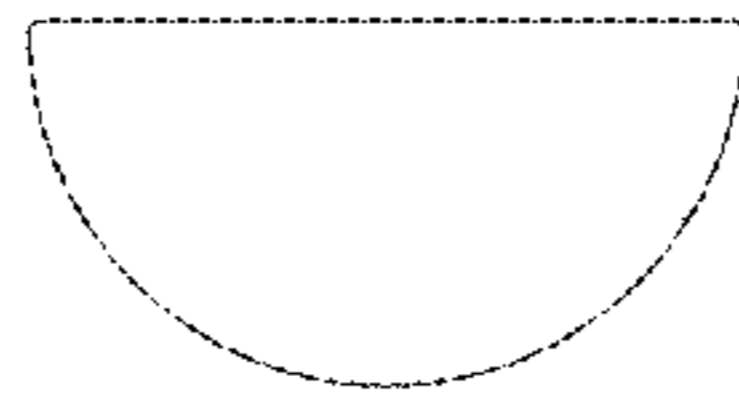

FIG. 45

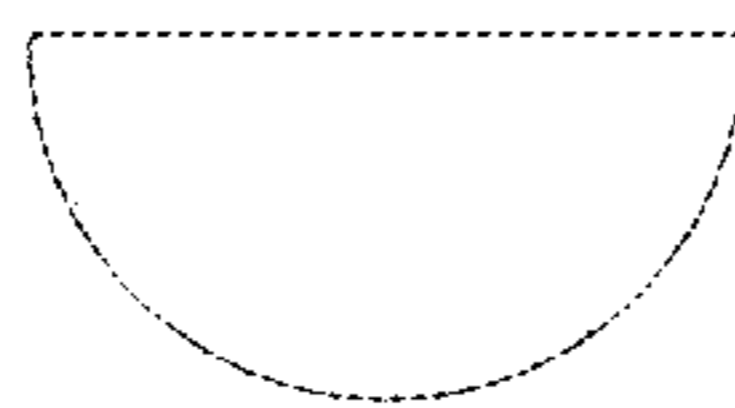

FIG. 46

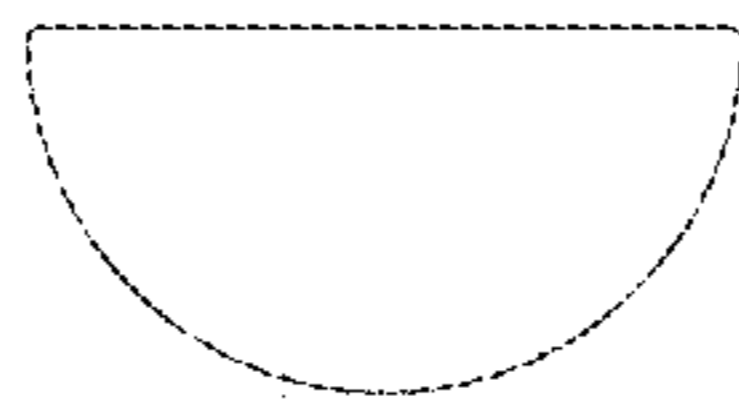

FIG. 47

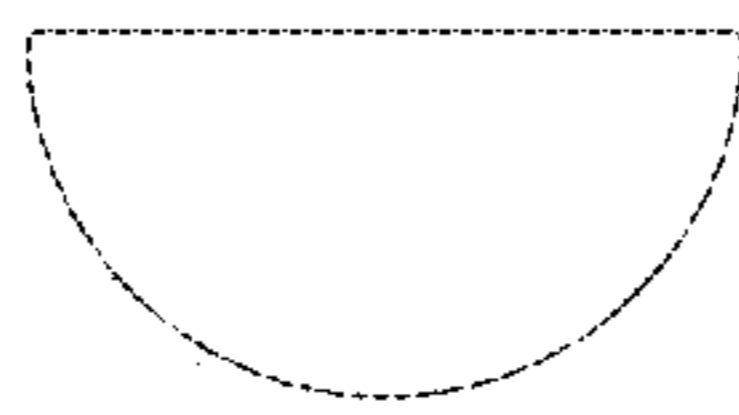

FIG. 48

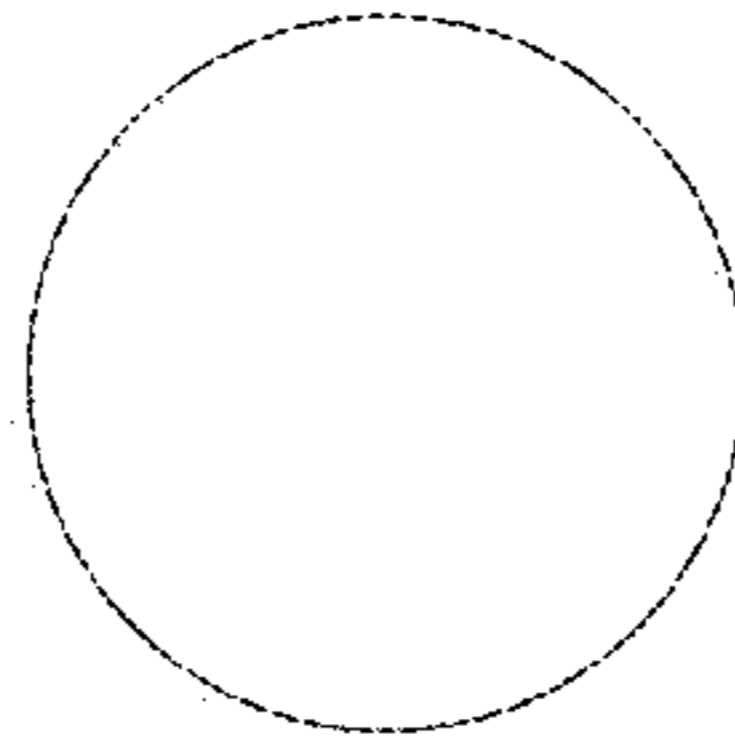

FIG. 49

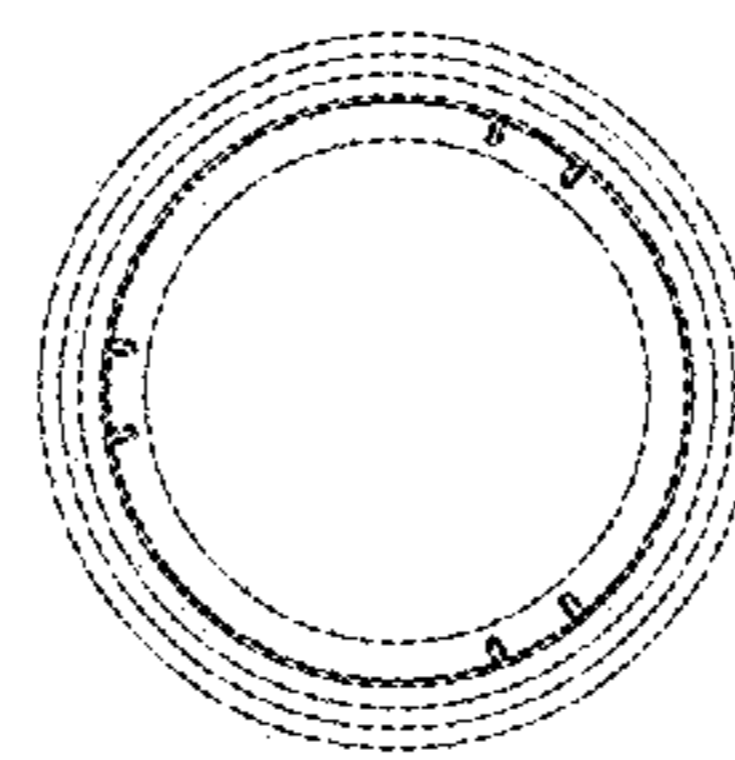

FIG. 50

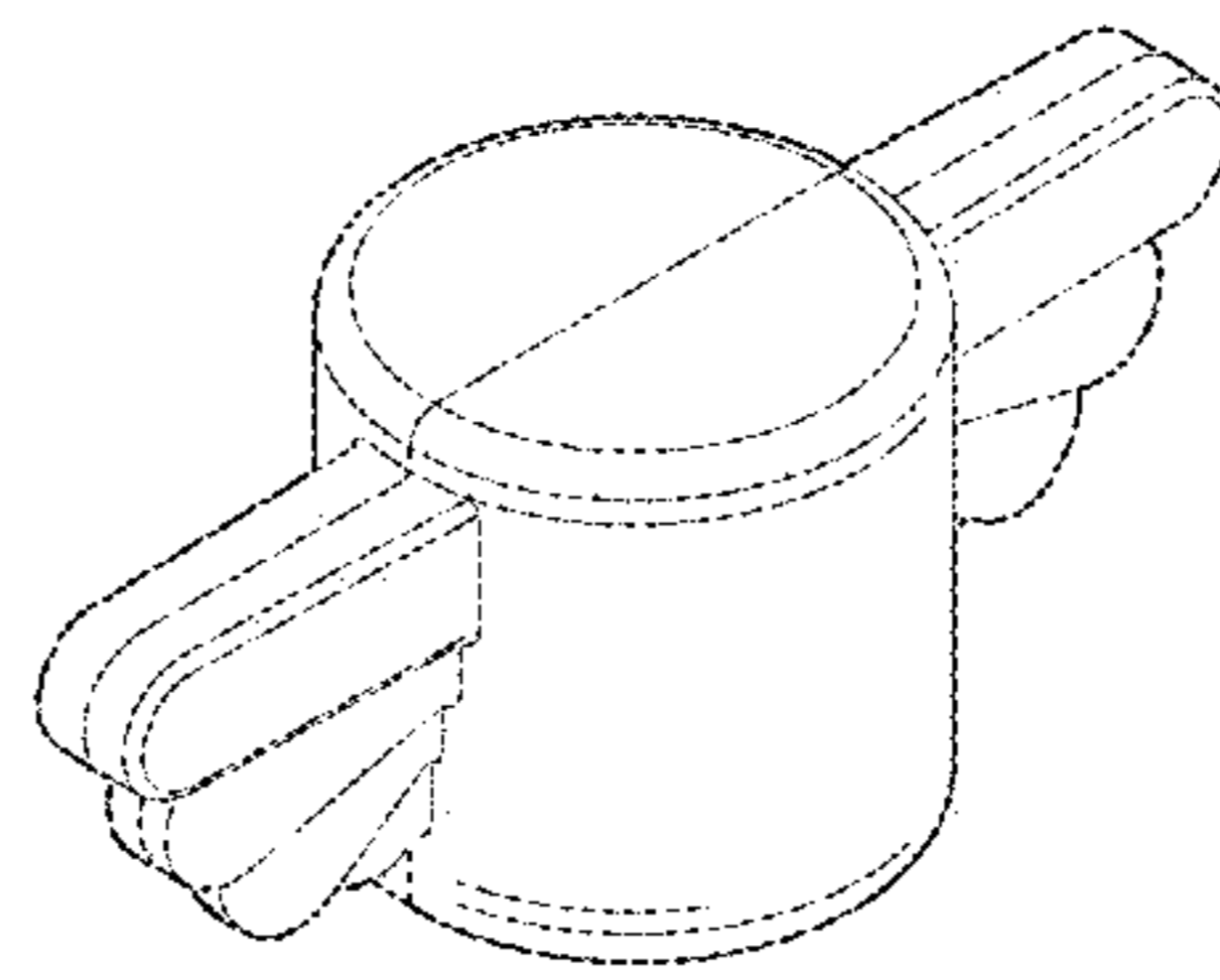

FIG. 51

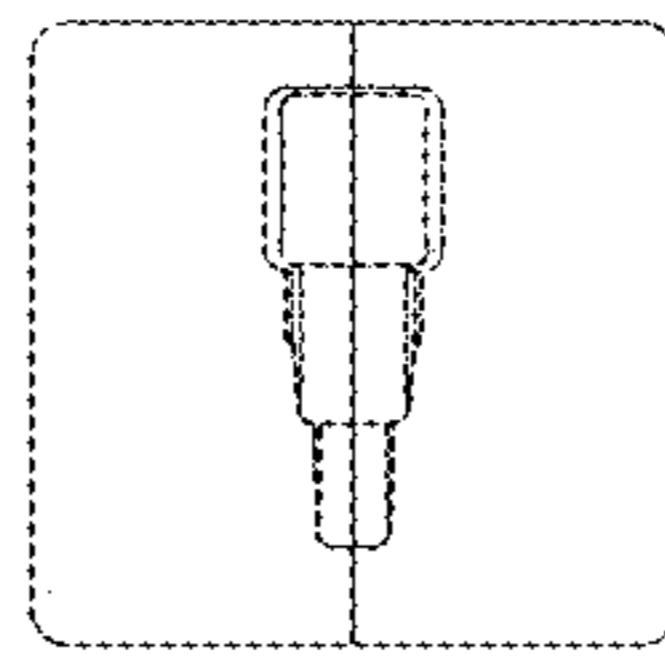

FIG. 52

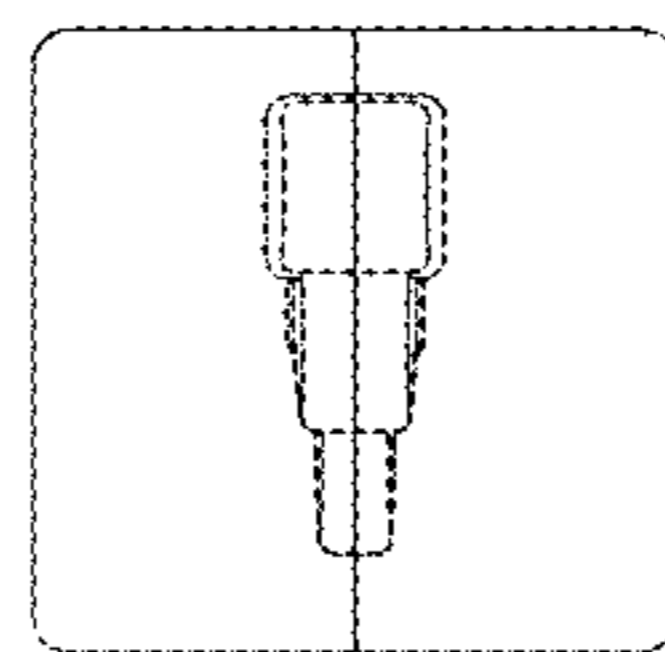

FIG. 53

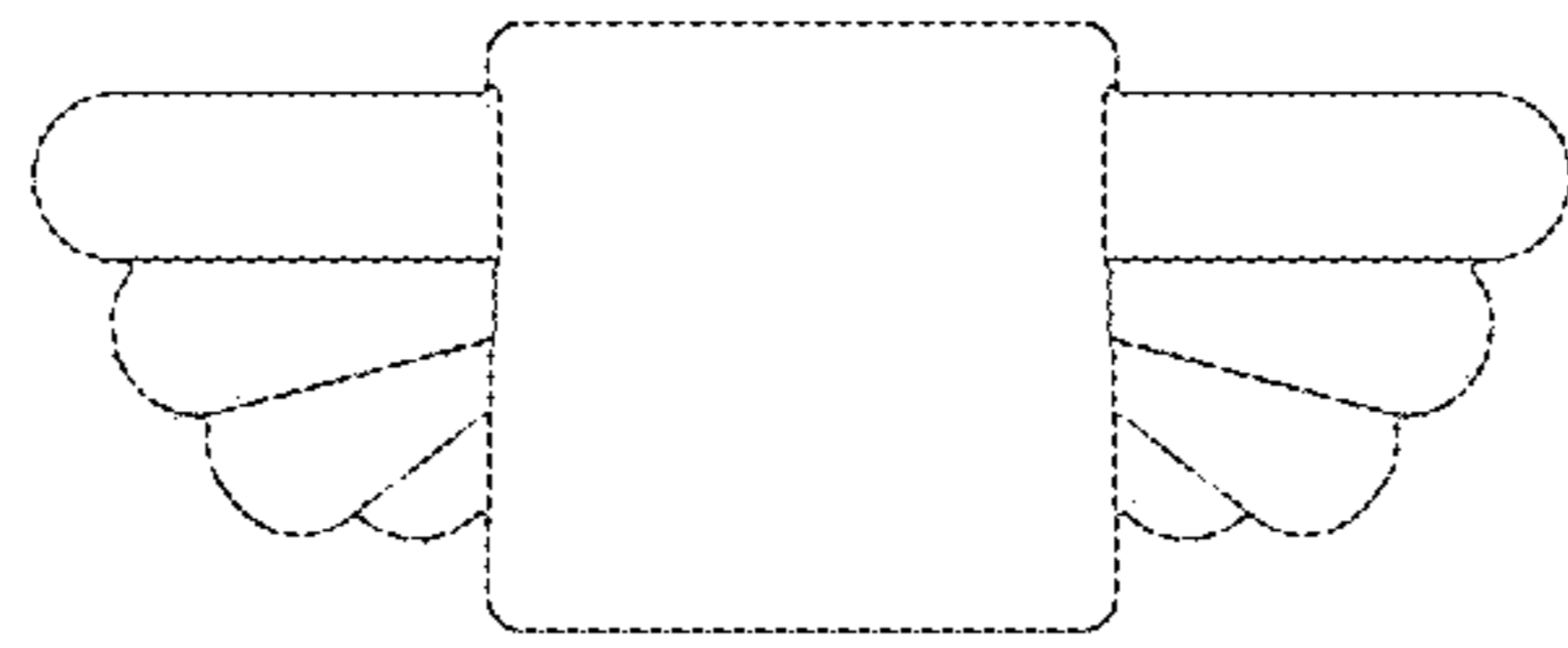

FIG. 54

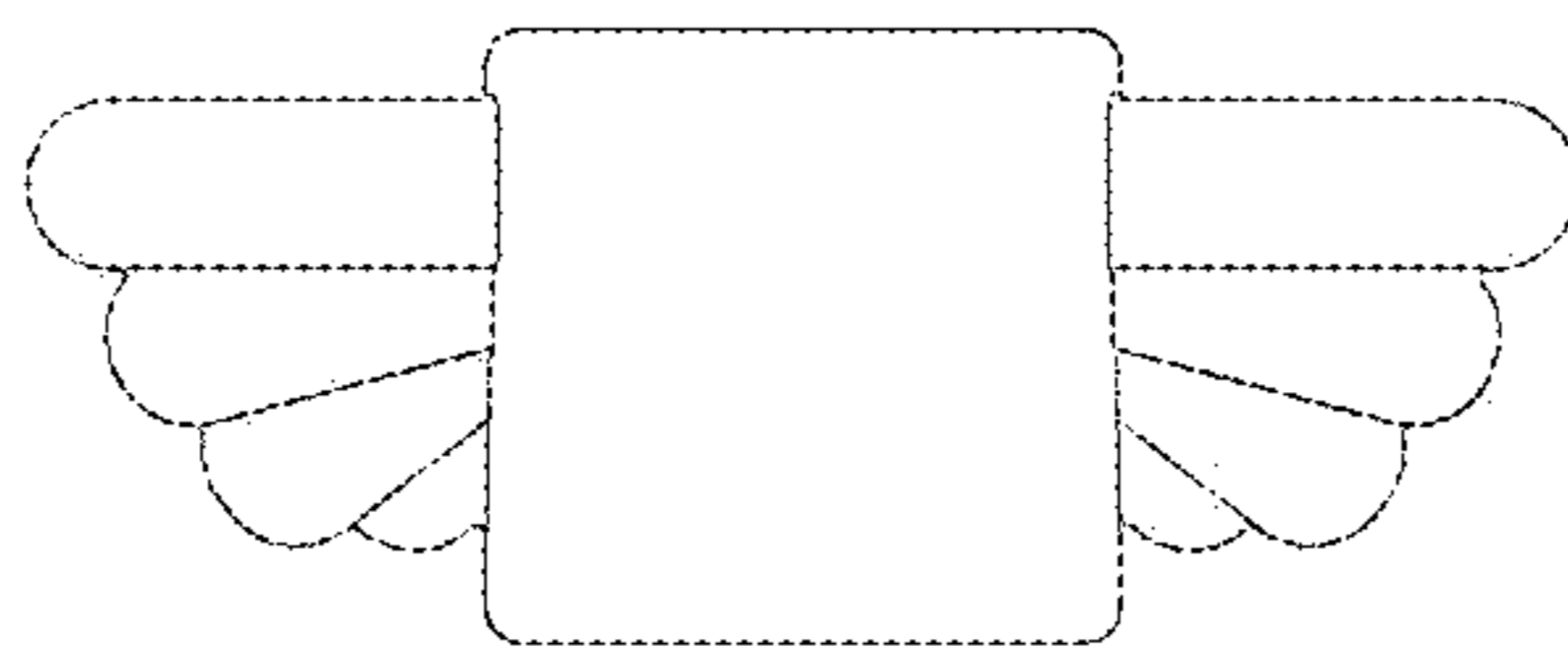

FIG. 55

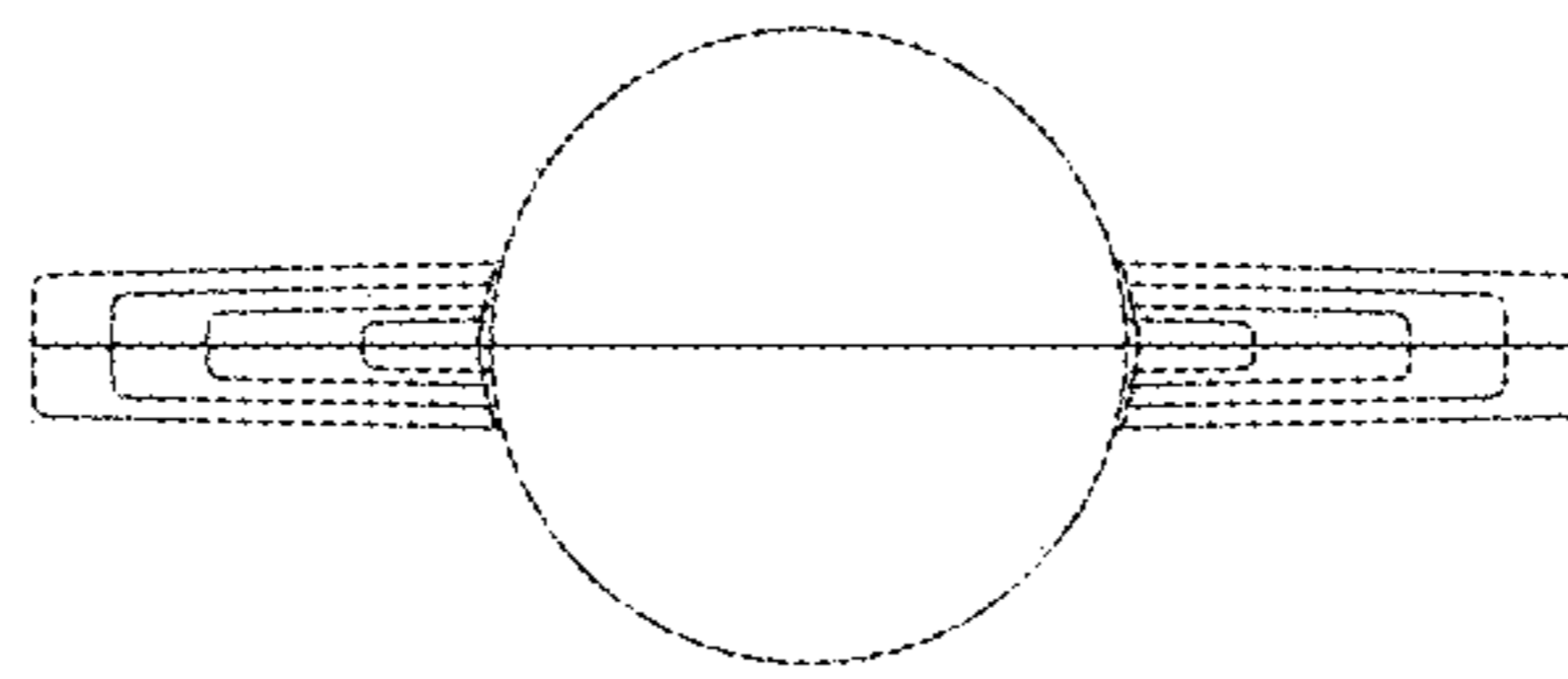

FIG. 56

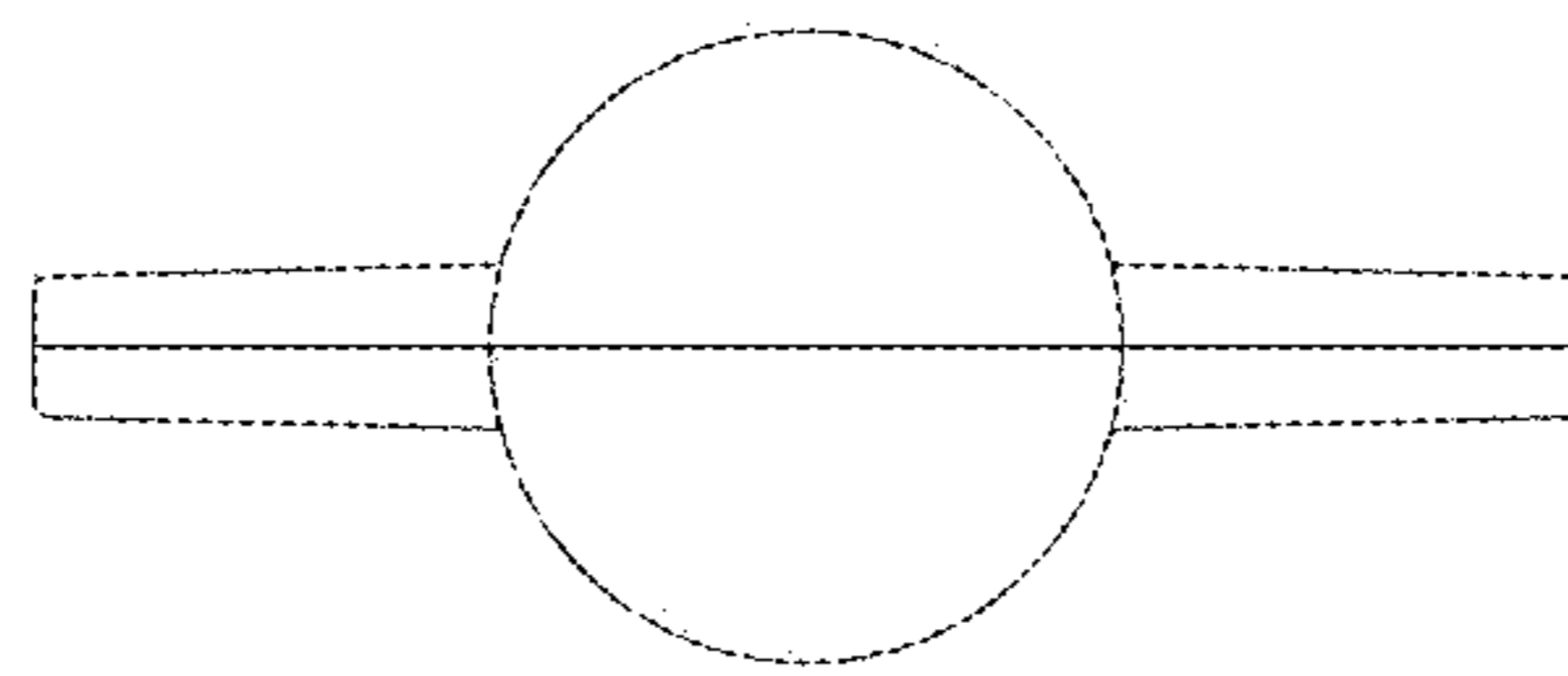

FIG. 57