



US00D916932S

(12) **United States Design Patent** (10) **Patent No.:** **US D916,932 S**  
**Cooper et al.** (45) **Date of Patent:** **\*\* Apr. 20, 2021**

- (54) **PUMP PORTION**
- (71) Applicant: **Wayne/Scott Fetzer Company**,  
Westlake, OH (US)
- (72) Inventors: **Buford A. Cooper**, Sunman, IN (US);  
**Michael S. Garcia**, Harrison, OH (US);  
**Joshua Michael Wilds**, Lancaster, NH  
(US)
- (73) Assignee: **Wayne/Scott Fetzer Company**,  
Westlake, OH (US)
- (\*\*) Term: **15 Years**
- (21) Appl. No.: **29/695,022**
- (22) Filed: **Jun. 14, 2019**

**Related U.S. Application Data**

- (60) Continuation of application No. 29/650,934, filed on Jun. 11, 2018, now Pat. No. Des. 875,142, which is a division of application No. 29/548,937, filed on Dec. 17, 2015, now Pat. No. Des. 823,345.
- (51) **LOC (13) Cl.** ..... **15-03**
- (52) **U.S. Cl.**  
USPC ..... **D15/7**
- (58) **Field of Classification Search**  
USPC ..... D15/7-9  
CPC ..... F02M 37/04; F02M 37/14; F04B 53/92;  
F04B 1/005; F04D 13/06; F04D 29/22;  
F04D 29/046; F04D 29/2266  
See application file for complete search history.

(56) **References Cited**

**U.S. PATENT DOCUMENTS**

2,333,243	A	11/1943	Glab
2,553,066	A	5/1951	Southern
2,863,525	A	12/1958	Lucian
3,400,732	A	9/1968	Larrabee
3,667,870	A	6/1972	Yoshida
3,684,096	A	8/1972	Kretchman
3,822,967	A	7/1974	Cade
3,936,240	A	2/1976	Dochterman

D243,281	S	2/1977	Pareja	
D252,811	S	9/1979	Arakawa	
4,482,300	A	11/1984	Brown	
4,820,131	A	4/1989	Johnson	
4,961,018	A	10/1990	Akhter	
5,055,000	A	10/1991	Akhter	
D328,304	S	7/1992	Frohn	
5,131,821	A	7/1992	Marioni	
D329,651	S	9/1992	Kuwada	
5,145,322	A	9/1992	Senior, Jr.	
5,145,337	A	9/1992	Kirkland	
5,181,841	A	1/1993	Kirkland	
5,205,725	A	4/1993	Pattison	
D335,292	S	5/1993	Schnell	
5,494,414	A	2/1996	Steinhart	
5,525,039	A	6/1996	Sieghartner	
D372,034	S	7/1996	Handzel	
5,599,164	A	2/1997	Murray	
D394,067	S	5/1998	Kon	
5,819,848	A	10/1998	Rasmuson	
5,833,437	A	11/1998	Kurth	
6,049,666	A	4/2000	Bennett	
6,059,542	A	5/2000	Chou	
6,149,390	A	11/2000	Fisher	
6,375,430	B1	4/2002	Eckert	
6,390,780	B1	5/2002	Batchelder	
6,423,218	B1	7/2002	Lindermeir	
6,443,715	B1	9/2002	Mayleben	
6,464,531	B2	10/2002	Eckert	
D466,527	S	12/2002	Graber	
6,530,758	B1	3/2003	Ritter	
6,575,714	B2	6/2003	Pace	
6,676,382	B2	1/2004	Leighton	
D501,486	S	2/2005	Leone	
D517,570	S	3/2006	Stiles, Jr.	
7,153,418	B2	12/2006	Mauro, Sr.	
7,264,449	B1	9/2007	Harned	
D555,089	S	11/2007	Lutz	
D589,060	S *	3/2009	Metcalf	D15/7
7,544,041	B2	6/2009	Mayleben	
D602,501	S	10/2009	Ton	
7,597,732	B2	10/2009	Yokota	
D603,870	S	11/2009	Mehnert	
D611,504	S	3/2010	Ton	
D667,466	S	9/2012	Moormann	
8,297,952	B2	10/2012	Wu	
8,380,355	B2	2/2013	Mayleben	
8,529,228	B1	9/2013	Thompson	
D691,638	S	10/2013	Alexander	
D698,368	S *	1/2014	Le	D15/7
8,633,623	B2	1/2014	Bingler	
8,636,898	B2	1/2014	Perez	
D706,834	S *	6/2014	Nowicki	D15/9

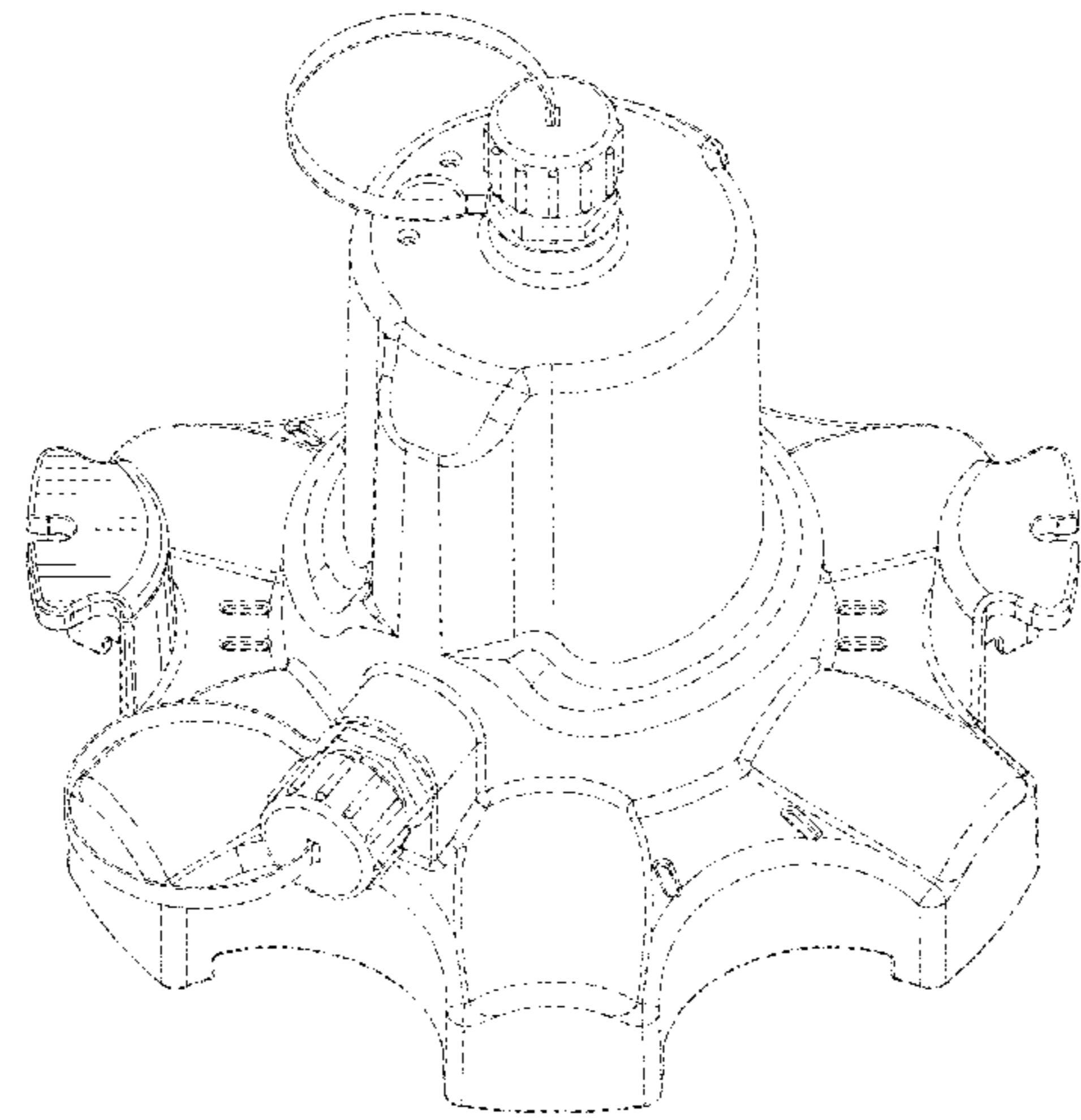

D707,718	S *	6/2014	Gomez	.....	D15/7
8,794,936	B2	8/2014	Tokuo		
D738,402	S	9/2015	Nelson		
D739,919	S *	9/2015	Alexander	.....	D23/233
D744,003	S	11/2015	Ton		
9,399,976	B2	7/2016	Ramamurthy		
D769,332	S	10/2016	Varini		
9,605,688	B2	3/2017	Perez		
D788,932	S *	6/2017	Ton	.....	D24/201
9,714,665	B2	7/2017	Saccoccio		
9,810,241	B2	11/2017	Gell, III		
D817,363	S *	5/2018	Alexander	.....	D15/7
9,964,111	B2	5/2018	Yano		
D823,345	S *	7/2018	Wilds	.....	D15/7
D823,898	S *	7/2018	Alexander	.....	D15/7
D836,677	S *	12/2018	Alexander	.....	D15/7
D848,487	S *	5/2019	van Opdorp	.....	D15/7
D868,117	S *	11/2019	Mayleben	.....	D15/7
D875,142	S *	2/2020	Wilds	.....	D15/7
D890,211	S *	7/2020	Cooper	.....	D15/7
10,711,788	B2 *	7/2020	Mayleben	.....	F04D 13/086
D893,552	S *	8/2020	Mayleben	.....	D15/7
10,760,586	B2	9/2020	Saccoccio		
2003/0002996	A1	1/2003	Pace		
2003/0091440	A1	5/2003	Patel		
2003/0161732	A1	8/2003	Kimberlin		
2005/0201858	A1	9/2005	Wang		
2005/0231899	A1	10/2005	Barnes		
2006/0064954	A1	3/2006	Yokota		
2006/0083630	A1	4/2006	Chen		
2006/0275162	A1	12/2006	Mayleben		
2008/0199326	A1	8/2008	Masoudipour		
2011/0123357	A1	5/2011	Leone		
2013/0214895	A1	8/2013	Ullermann		
2014/0166109	A1	6/2014	Takai		
2014/0286747	A1	9/2014	Fang		
2014/0341752	A1	11/2014	Gell, III		
2015/0167673	A1	6/2015	Saccoccio		
2015/0308425	A1	10/2015	Skotty		
2016/0037987	A1	2/2016	Caro		
2017/0030371	A1	2/2017	Wilds		
2019/0048875	A1	2/2019	Mayleben		
2019/0154061	A1	5/2019	Gilliland		
2019/0309757	A1	10/2019	Rejniak		

FOREIGN PATENT DOCUMENTS

CN	203548187	4/2014
CN	201330537433	6/2014
EM	000673363	2/2007
EM	000777123	8/2007
EM	001379309	7/2013
EM	001388441	10/2013
EM	0027086770002	5/2015
EM	0027086770004	5/2015
EP	1178212	2/2002
EP	1241357	9/2002
EP	3058800	A1 8/2016
GB	1320841	A 6/1973
RU	2489784	7/2013
RU	166537	11/2016
WO	0017521	3/2000
WO	2006137777	12/2006
WO	2011137425	11/2011
WO	2012037991	3/2012

OTHER PUBLICATIONS

Wayne/Scott Fetzer Company, Watering & System Installation Guide, Dewatering Pump TSC, that discloses a pump that was on sale or publicly disclosed more than 1 year before the filing date of the instant application, 2016, 11 pp.

Wayne/Scott Fetzer Company, Operating Instructions and Replacement Parts List, Submersible Utility Pumps VIP Series, that dis-

closes a pump that was on sale or publicly disclosed more than 1 year before the filing date of the instant application, 2011, 12 pp. Blue Angel Pump Company, Blue Angel Catalog, 2018, 34 pp. Blue Angel Pump Company, Blue Angel Catalog, Oct. 2015, 39 pp. Wayne Water Systems, Wayne Catalog, Oct. 2014, 52 pp. Patent Cooperation Treaty, International Searching Authority, Notification of Transmittal of the International Search Report and the Written Opinion of the International Searching Authority, or the Declaration issued in International Application No. PCT/US2018/046604, Nov. 29, 2018, 11 pp.

\* cited by examiner

Primary Examiner — Khawaja Anwar  
(74) Attorney, Agent, or Firm — Fitch, Even, Tabin & Flannery, LLP

(57) CLAIM

We claim the ornamental design for a pump portion, as shown and described.

DESCRIPTION

FIG. 1 is a perspective view of a pump portion, showing the first embodiment of our new design;  
FIG. 2 is a left side elevation view thereof;  
FIG. 3 is a right side elevation view thereof;  
FIG. 4 is a front elevation view thereof;  
FIG. 5 is a rear elevation view thereof;  
FIG. 6 is a top plan view thereof;  
FIG. 7 is a bottom plan view thereof;  
FIG. 8 is a perspective view of a pump portion, showing the second embodiment of our new design;  
FIG. 9 is a left side elevation view thereof;  
FIG. 10 is a right side elevation view thereof;  
FIG. 11 is a front elevation view thereof;  
FIG. 12 is a rear elevation view thereof;  
FIG. 13 is a top plan view thereof;  
FIG. 14 is a bottom plan view thereof;  
FIG. 15 is a perspective view of a pump portion, showing the third embodiment of our new design;  
FIG. 16 is a left side elevation view thereof;  
FIG. 17 is a right side elevation view thereof;  
FIG. 18 is a front elevation view thereof;  
FIG. 19 is a rear elevation view thereof;  
FIG. 20 is a top plan view thereof;  
FIG. 21 is a bottom plan view thereof;  
FIG. 22 is a perspective view of a pump portion, showing the fourth embodiment of our new design;  
FIG. 23 is a left side elevation view thereof;  
FIG. 24 is a right side elevation view thereof;  
FIG. 25 is a front elevation view thereof;  
FIG. 26 is a rear elevation view thereof;  
FIG. 27 is a top plan view thereof; and,  
FIG. 28 is a bottom plan view thereof.

As mentioned above, the pump components and portions of the pump shown in broken lines in the figures depict unclaimed environmental subject matter, are for illustrative purposes only, and form no part of the claimed design. Similarly, unshaded portions that appear between broken lines or beyond boundary or break lines in the figures form no part of the claimed design.

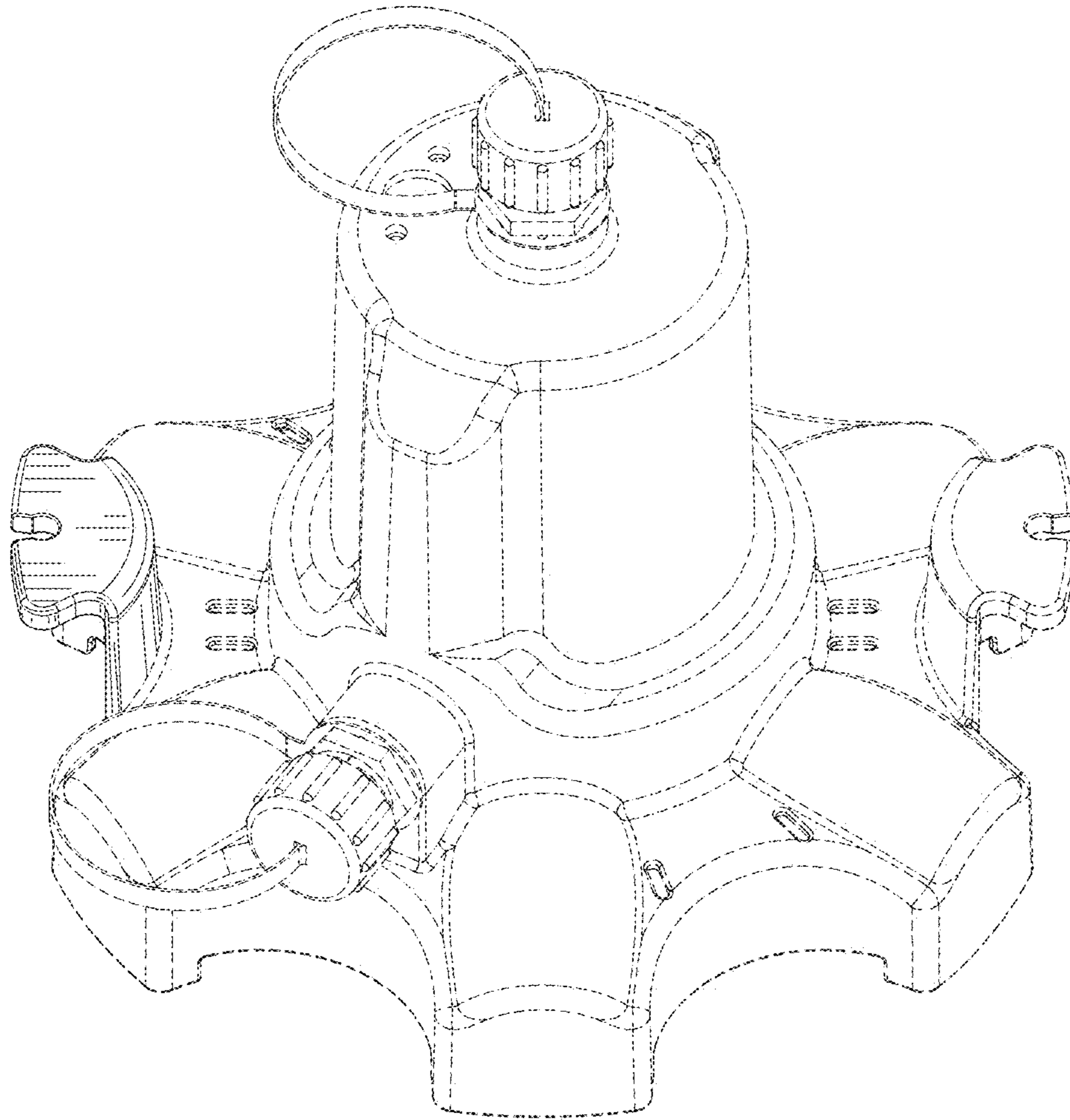

FIG. 1

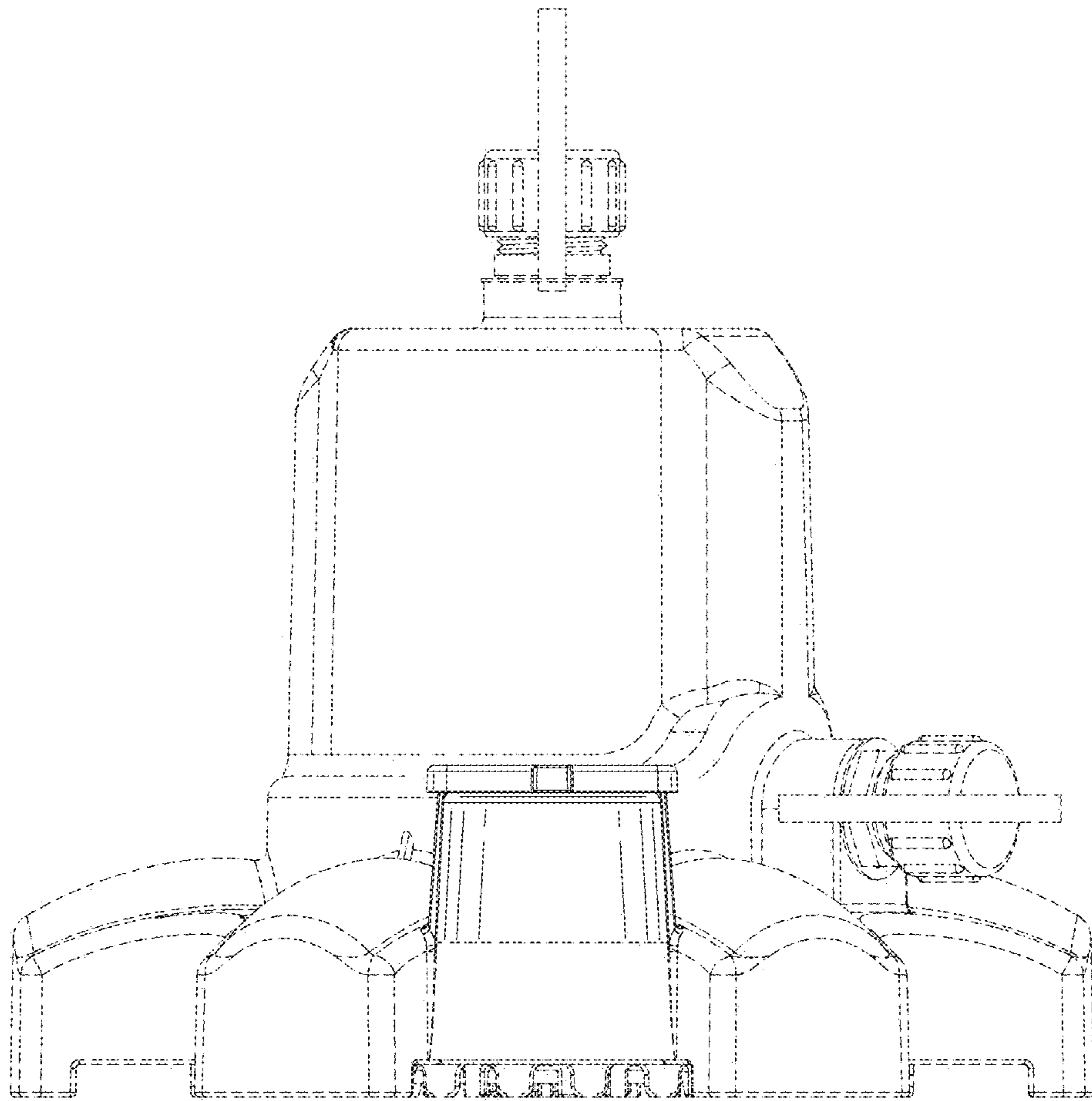

FIG. 2

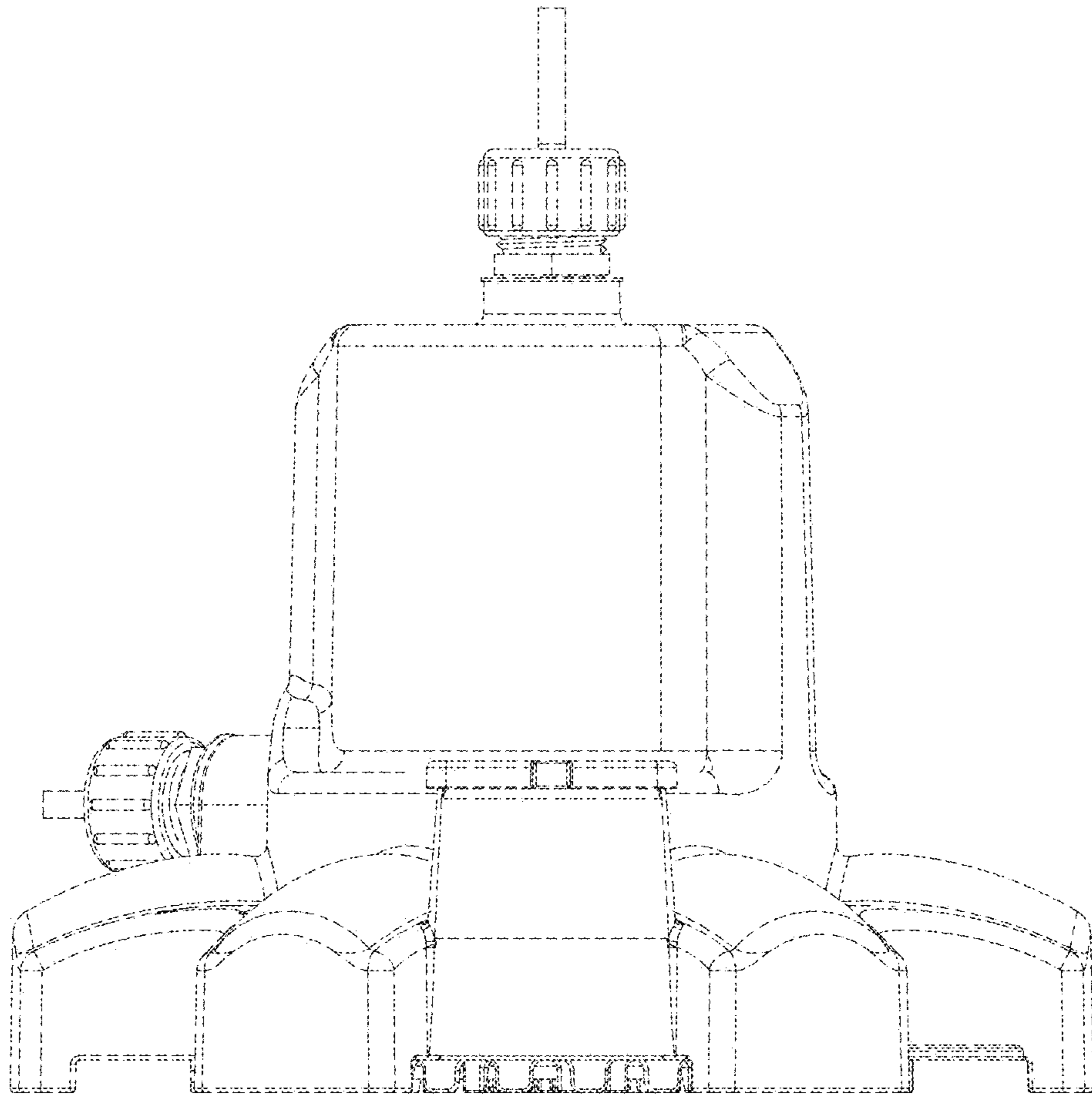

FIG. 3

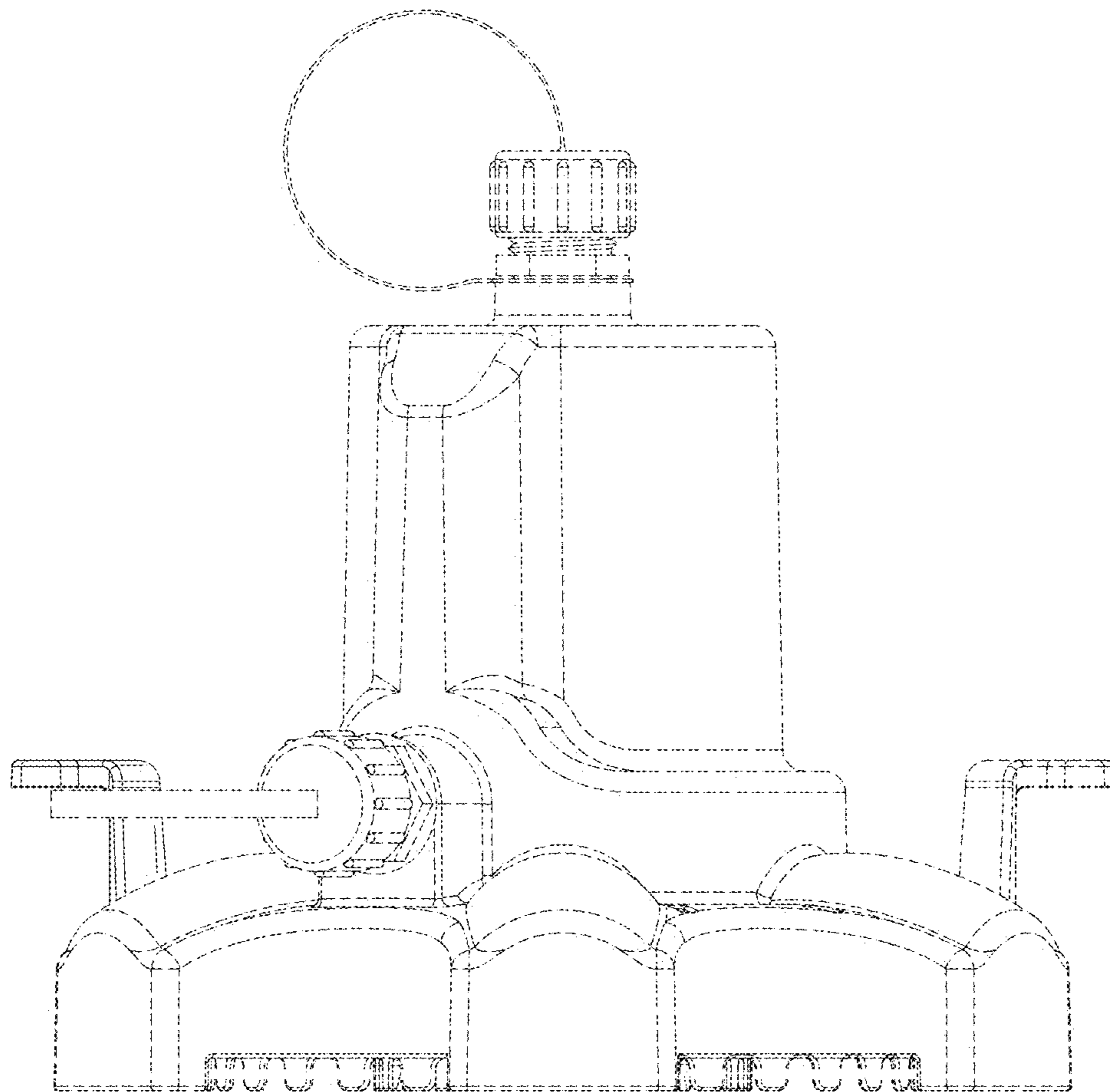

FIG. 4

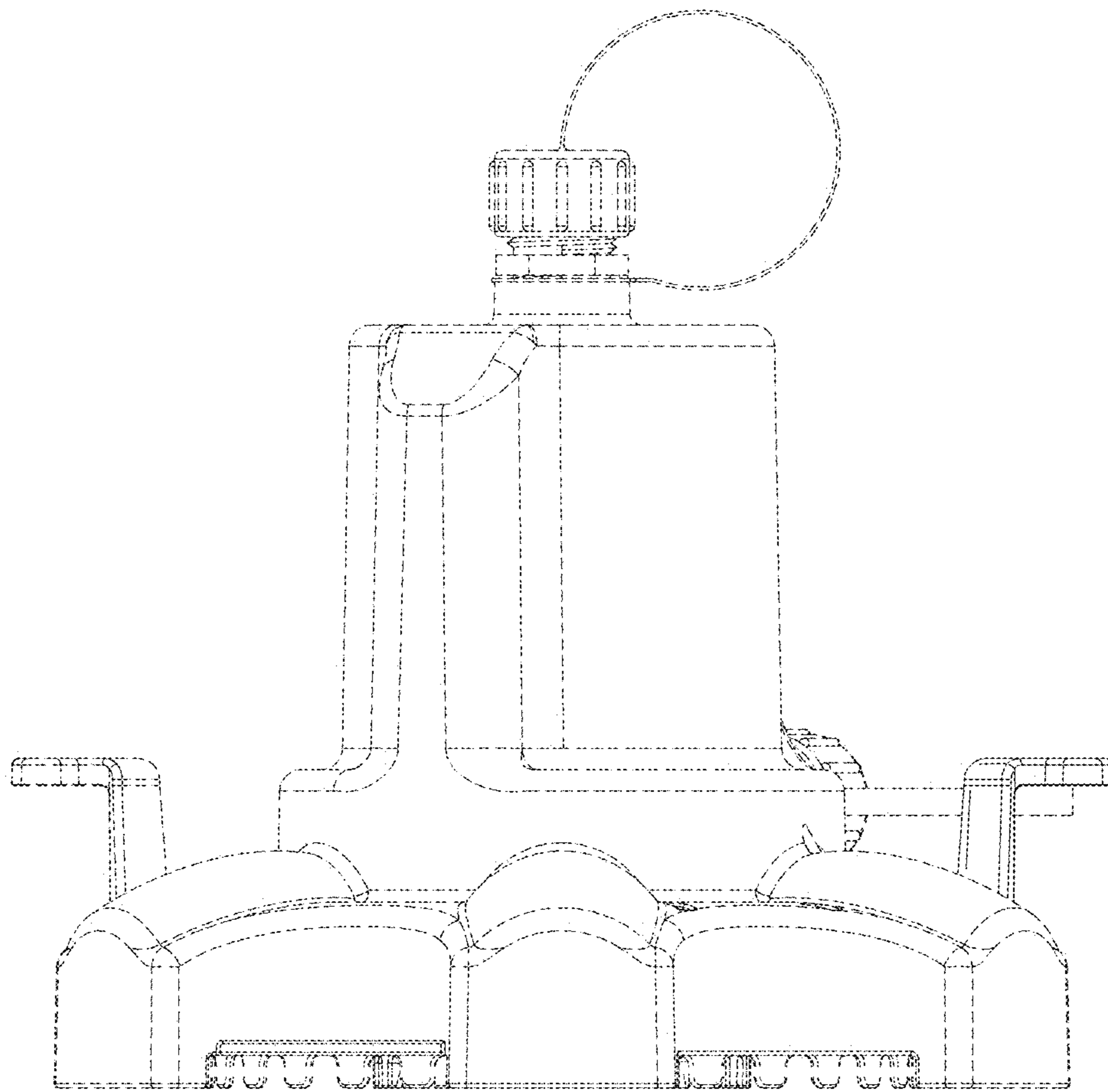

FIG. 5

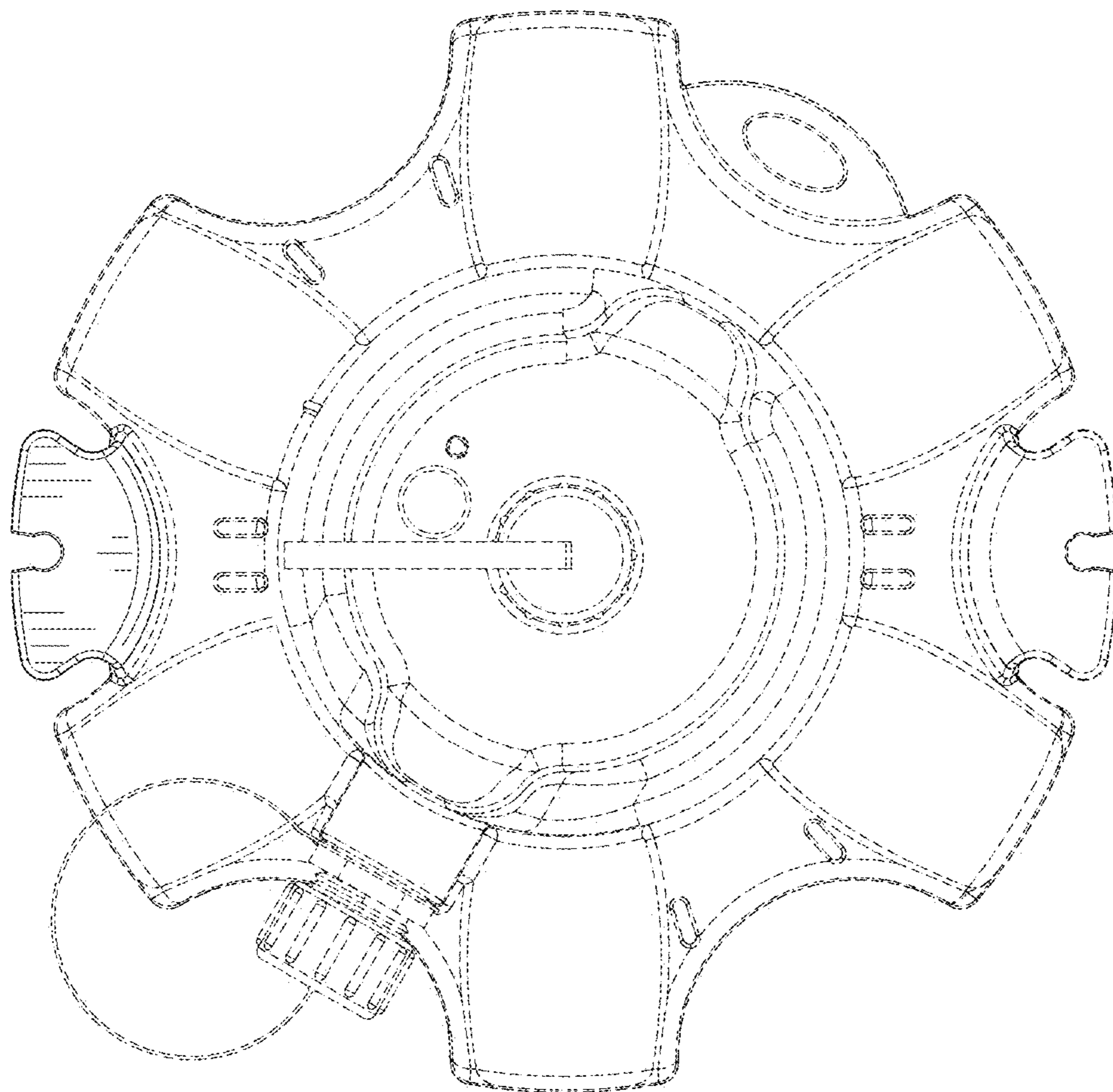

FIG. 6



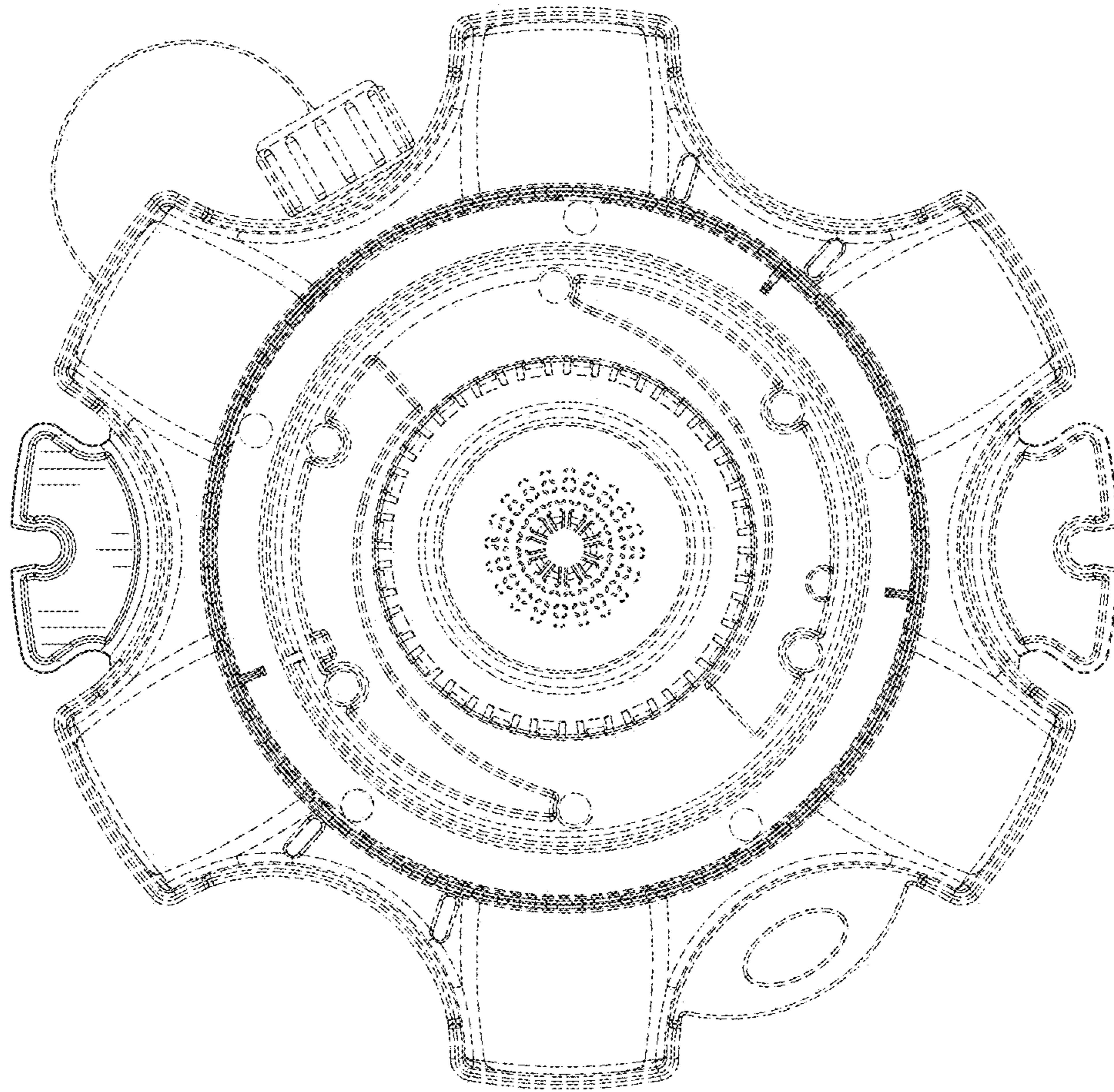

FIG. 7

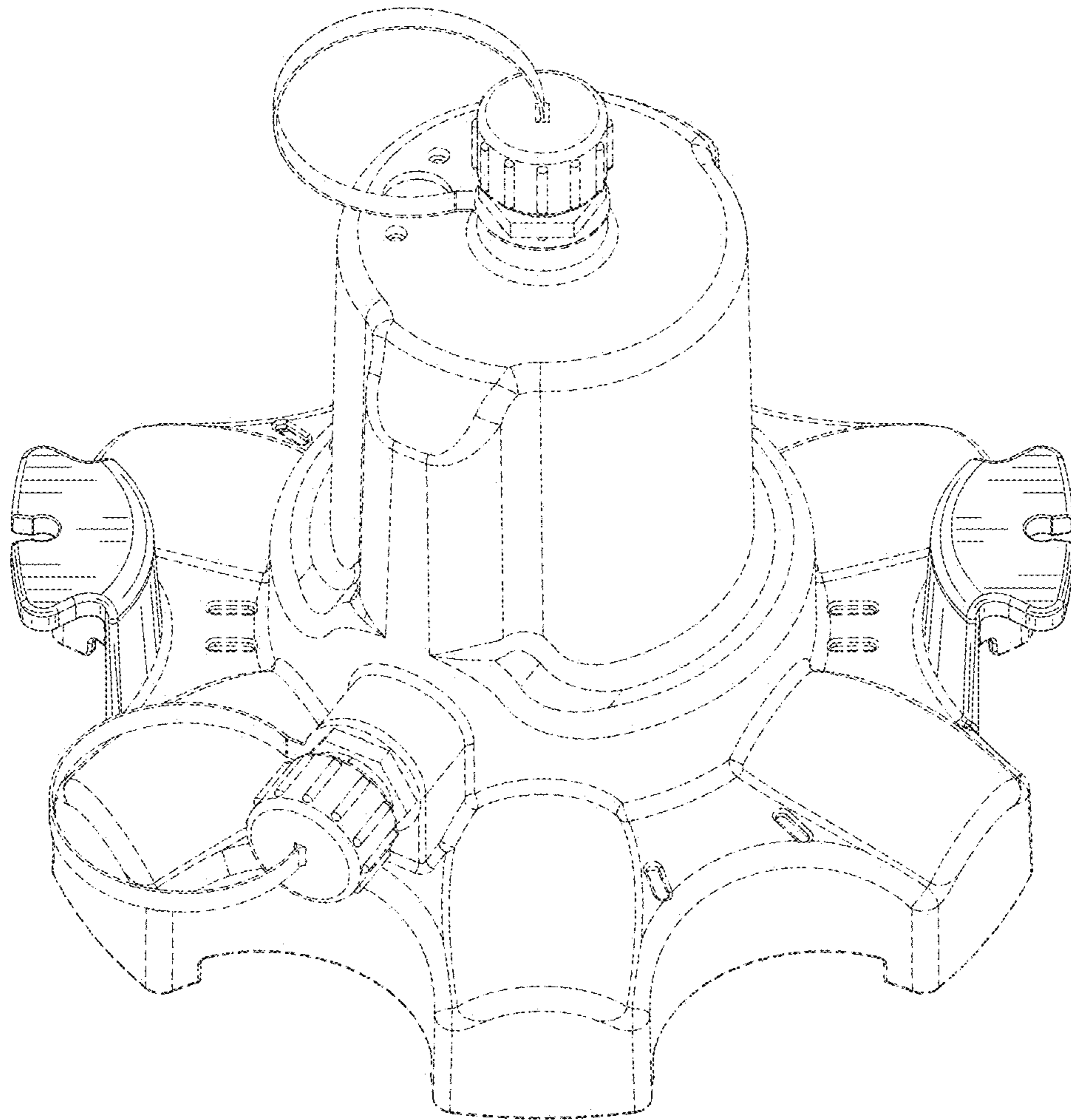

FIG. 8

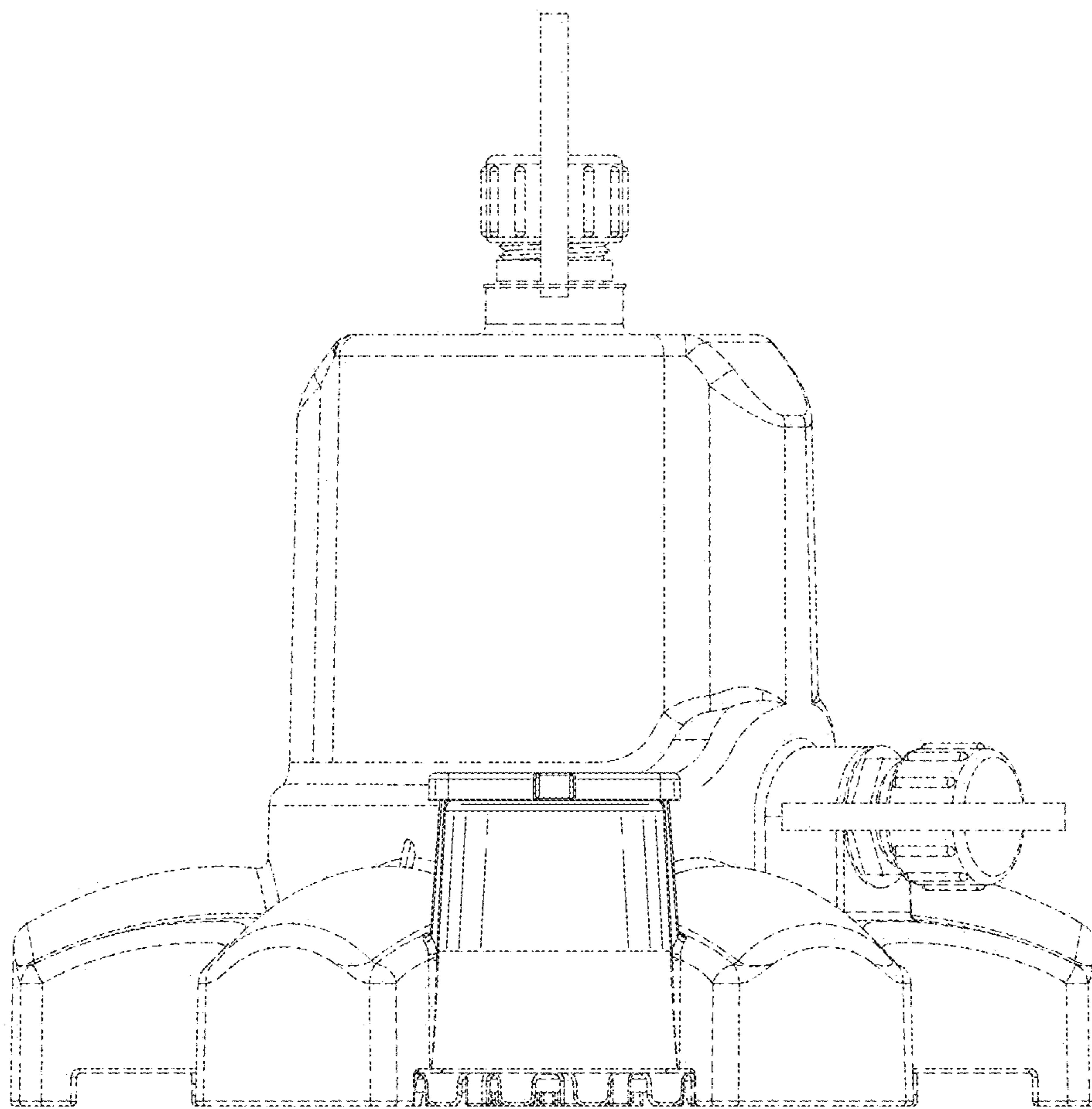

FIG. 9

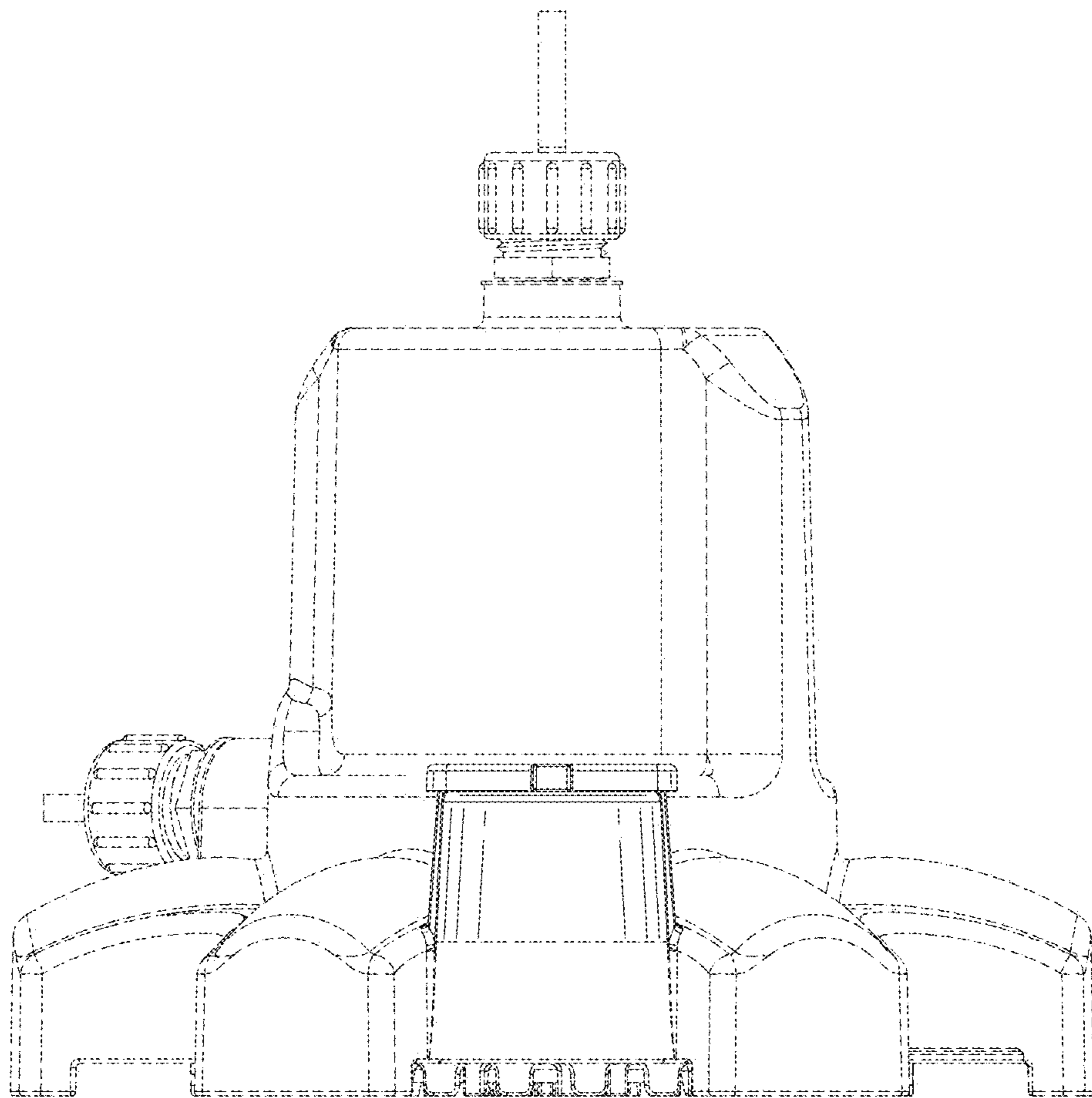

FIG. 10

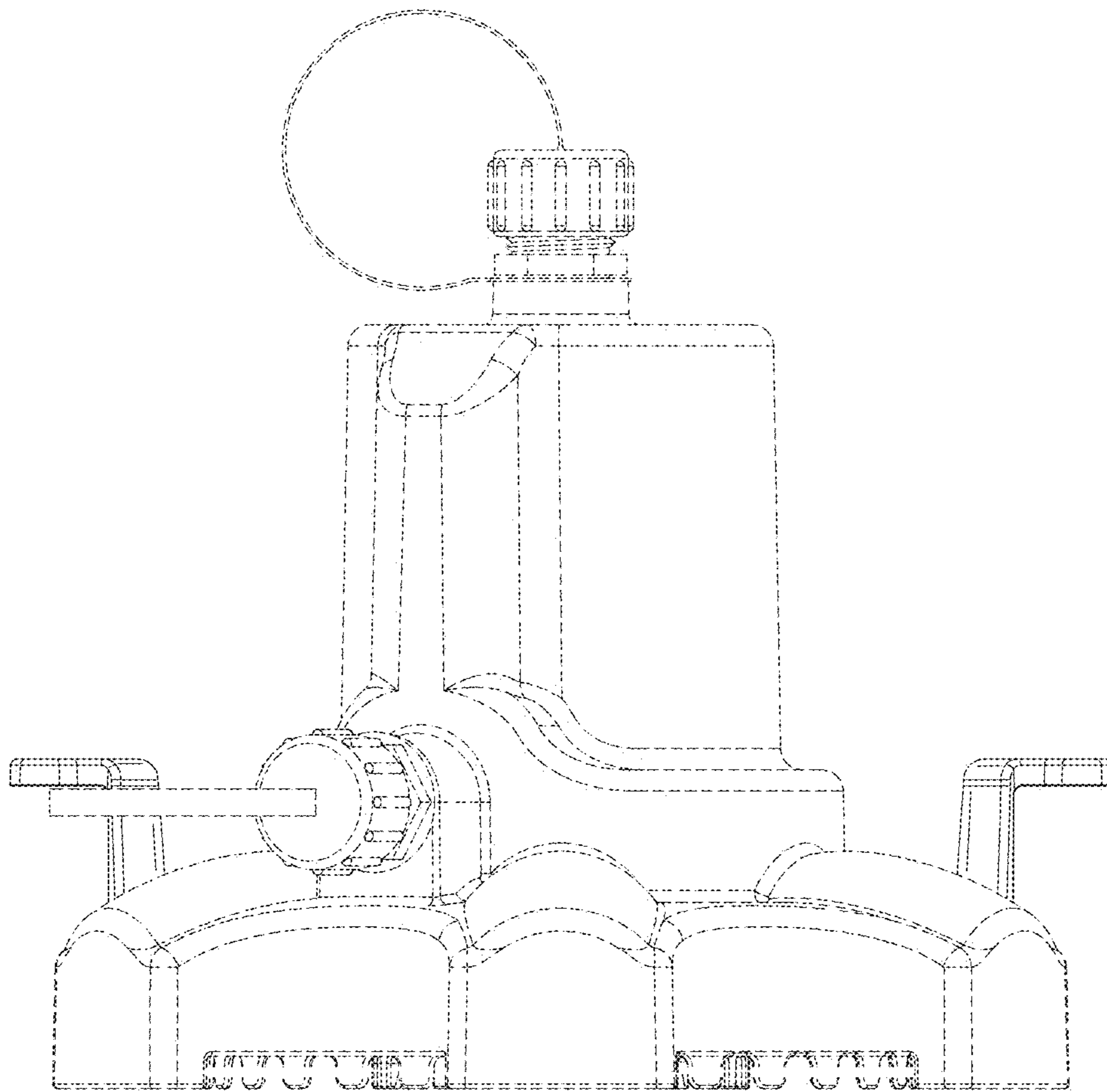

FIG. 11

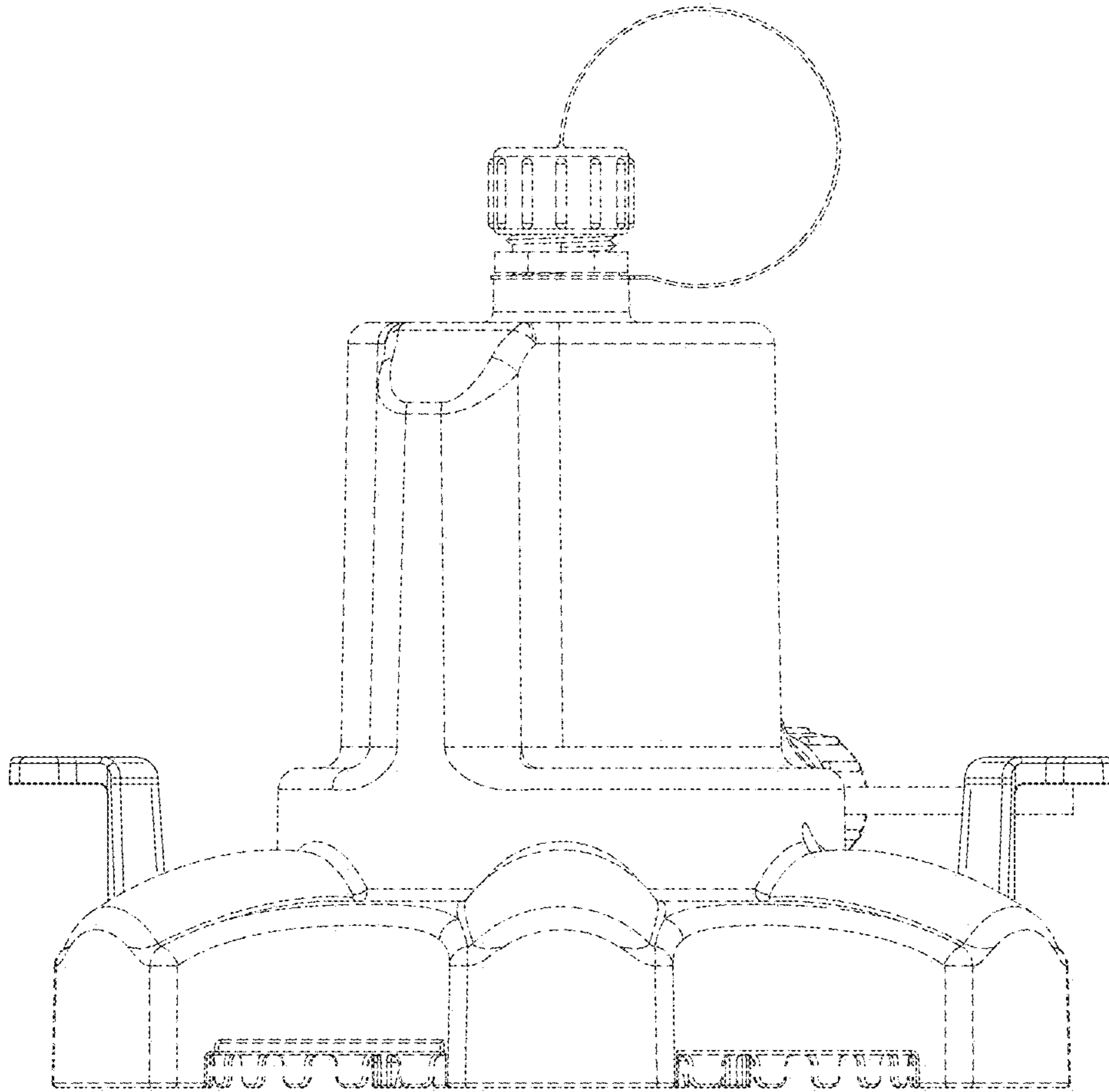

FIG. 12

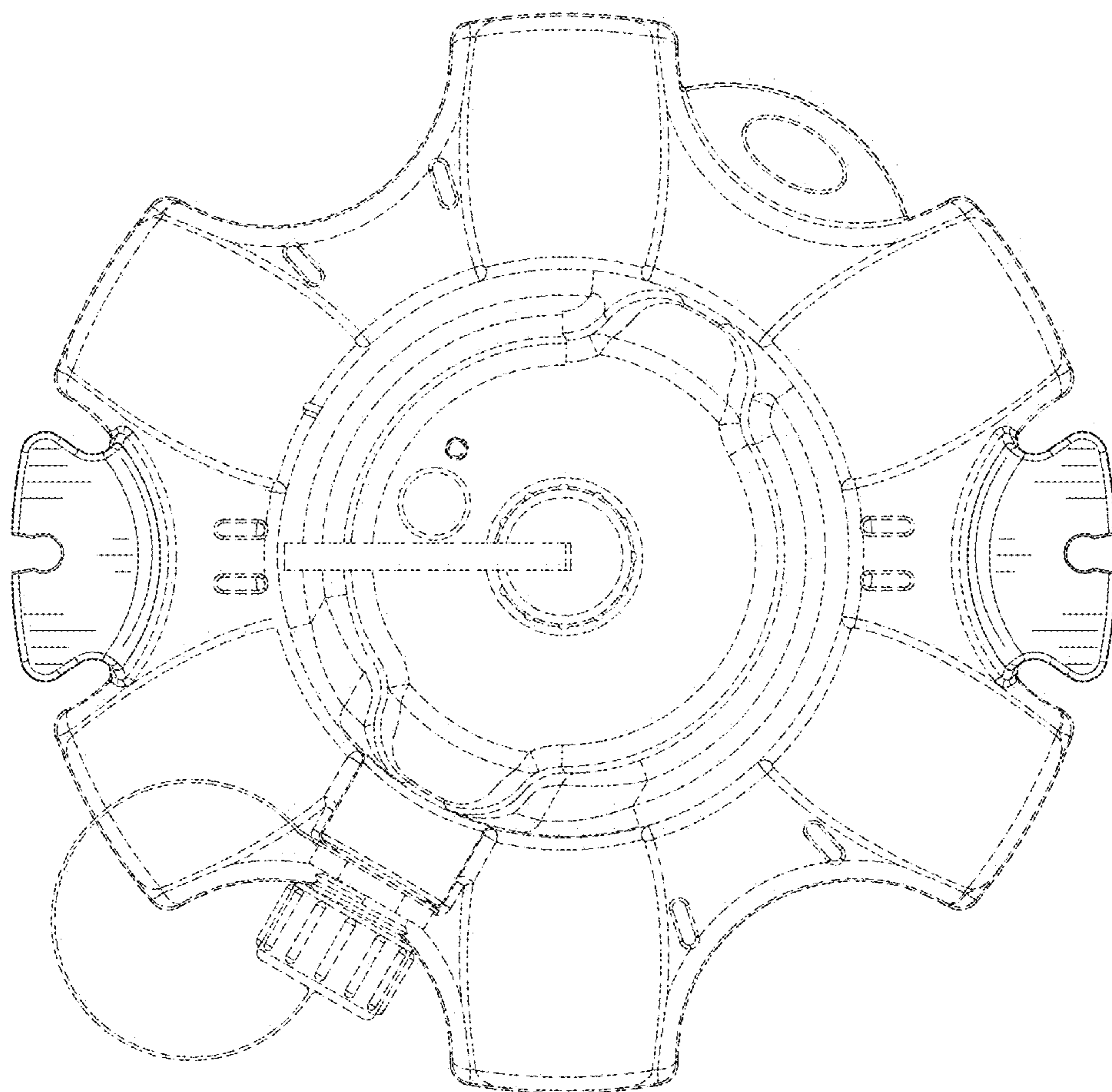

FIG. 13

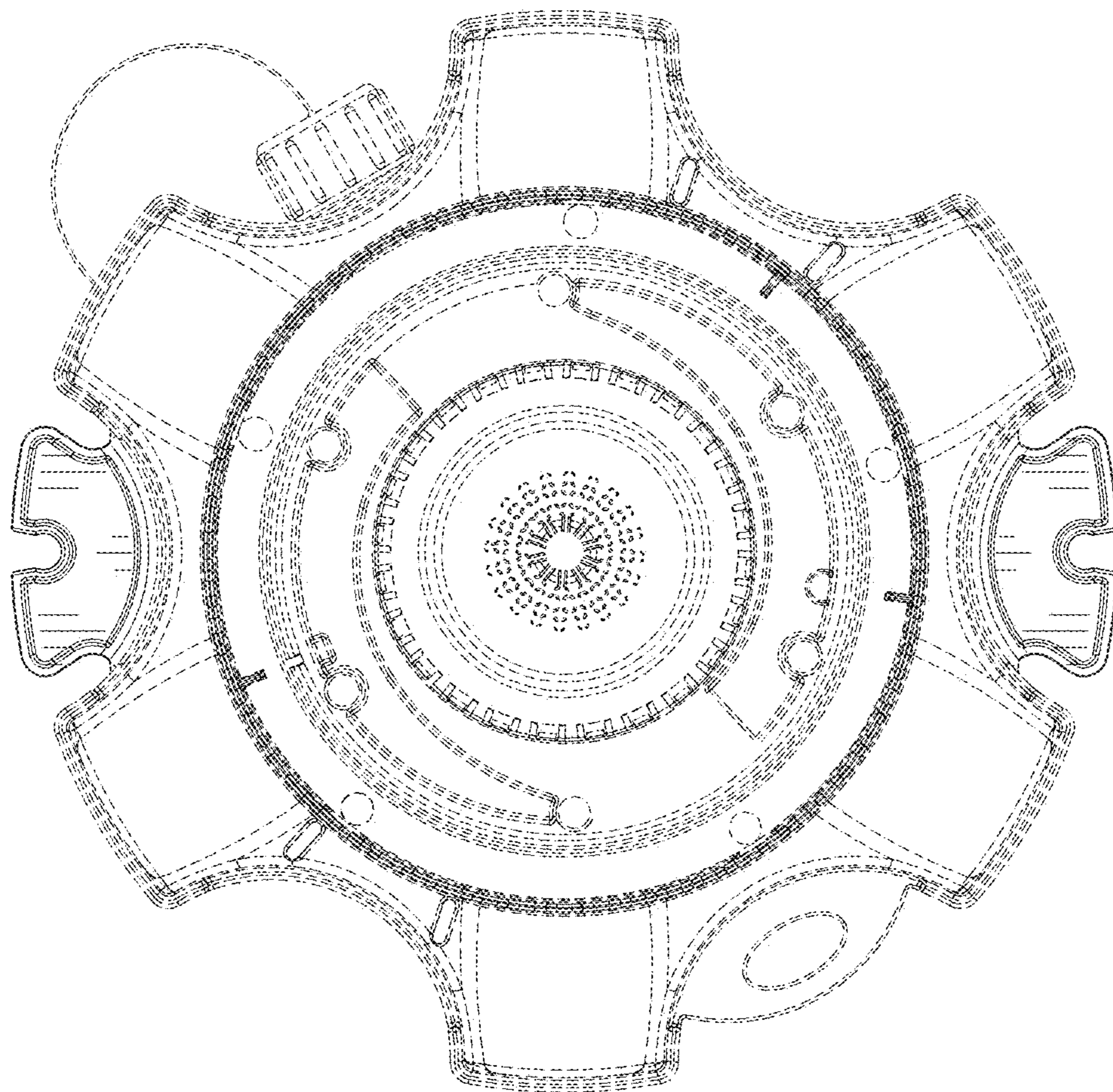

FIG. 14



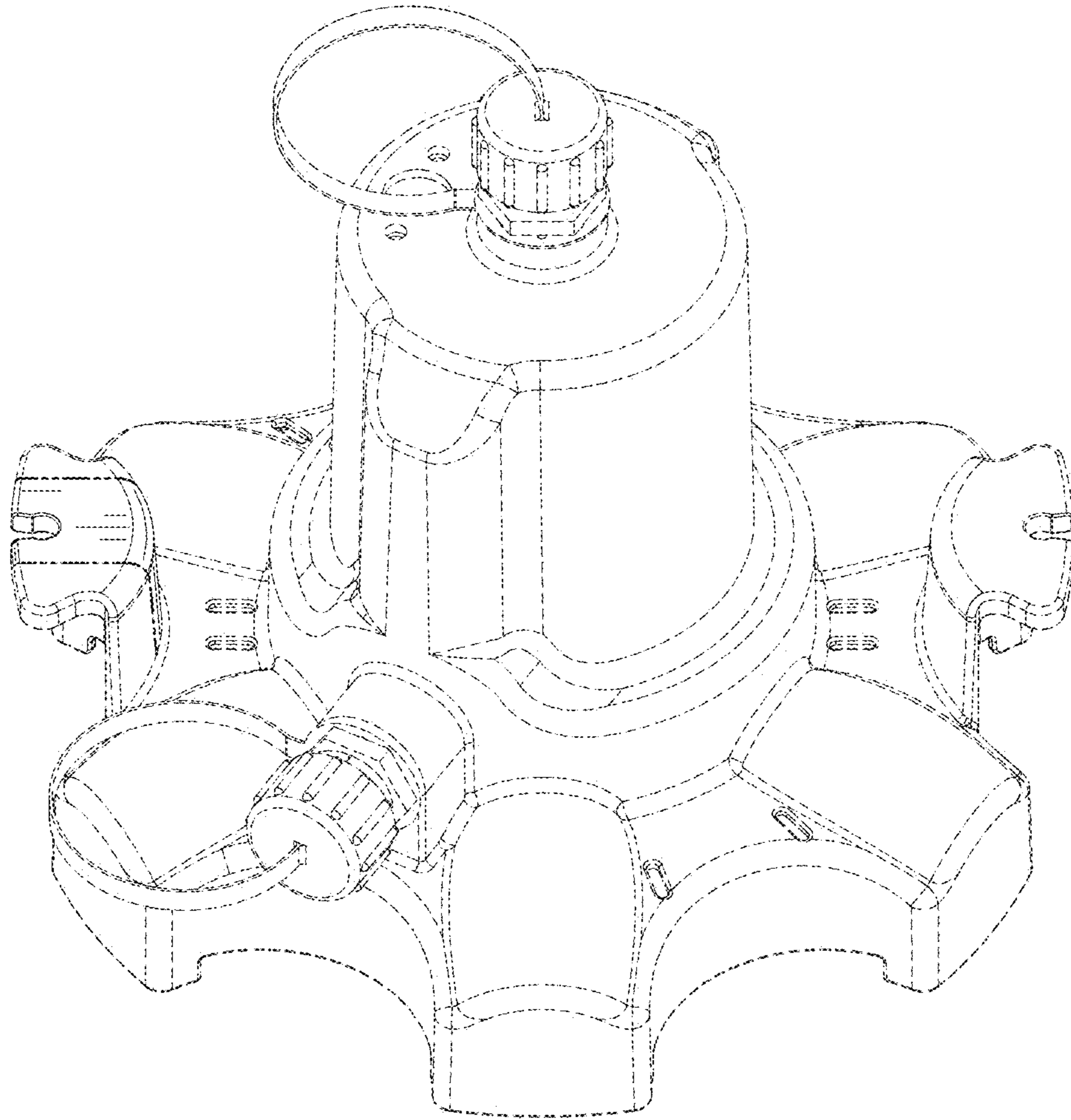

FIG. 15

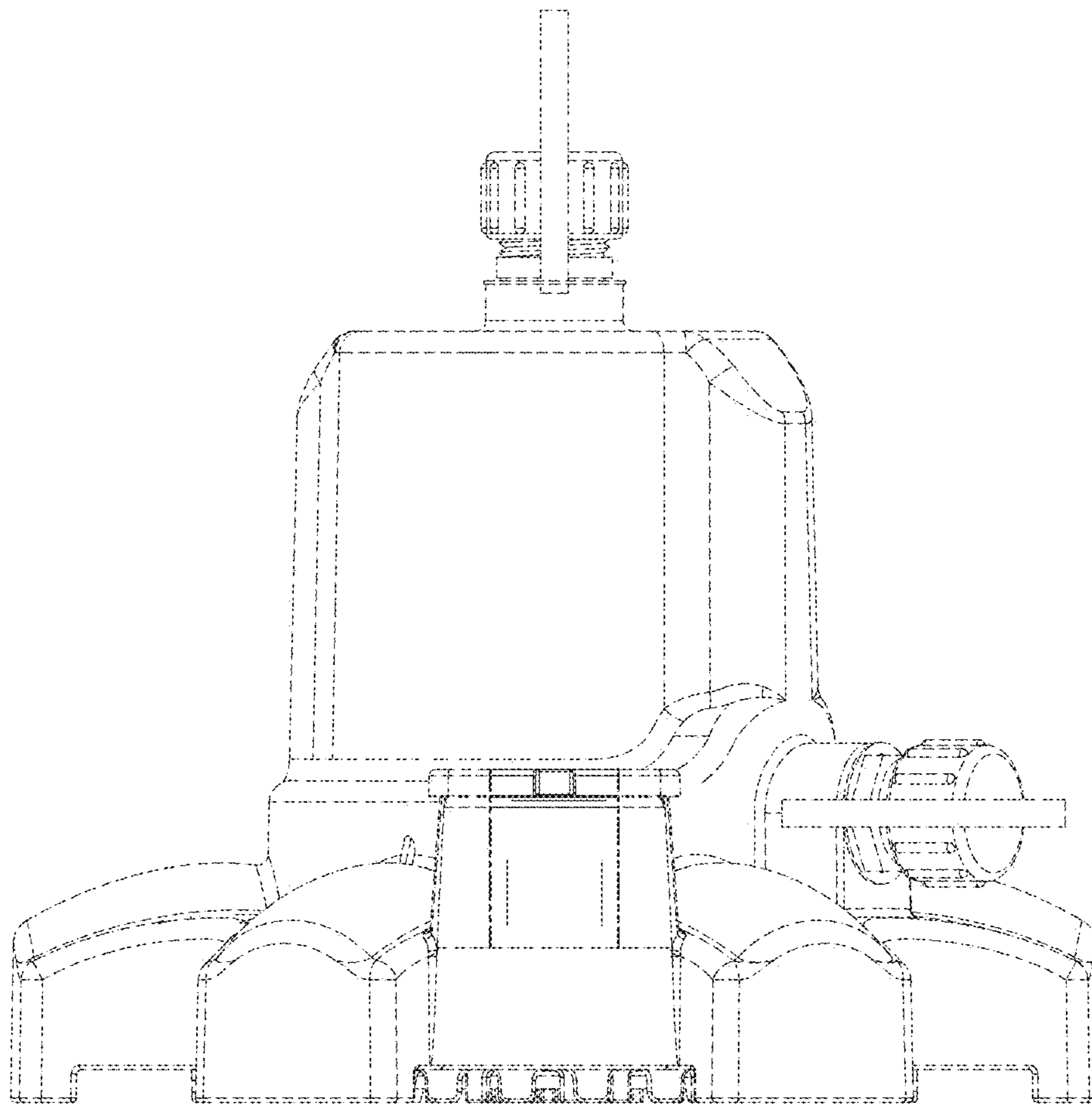

FIG. 16

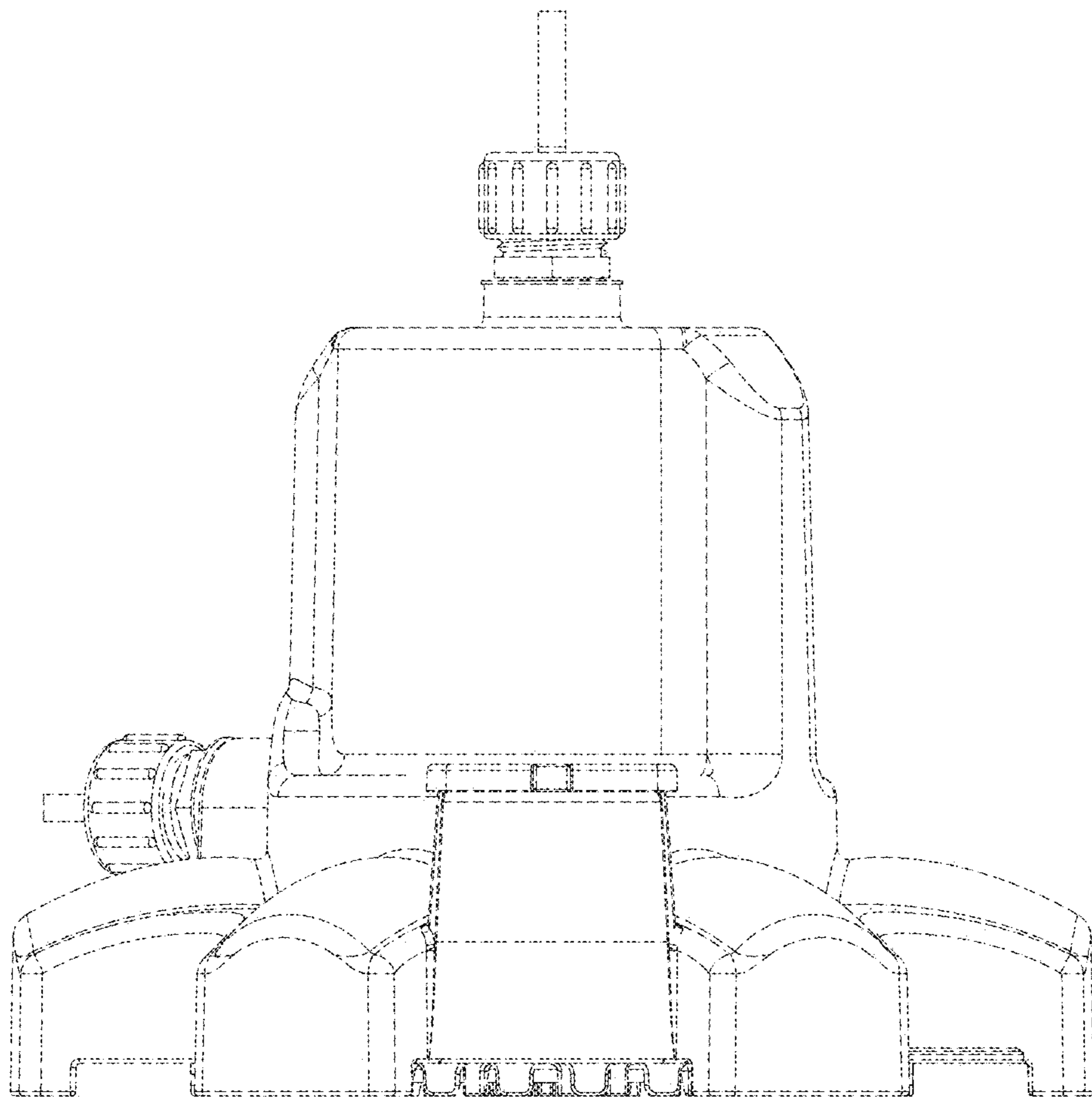

FIG. 17

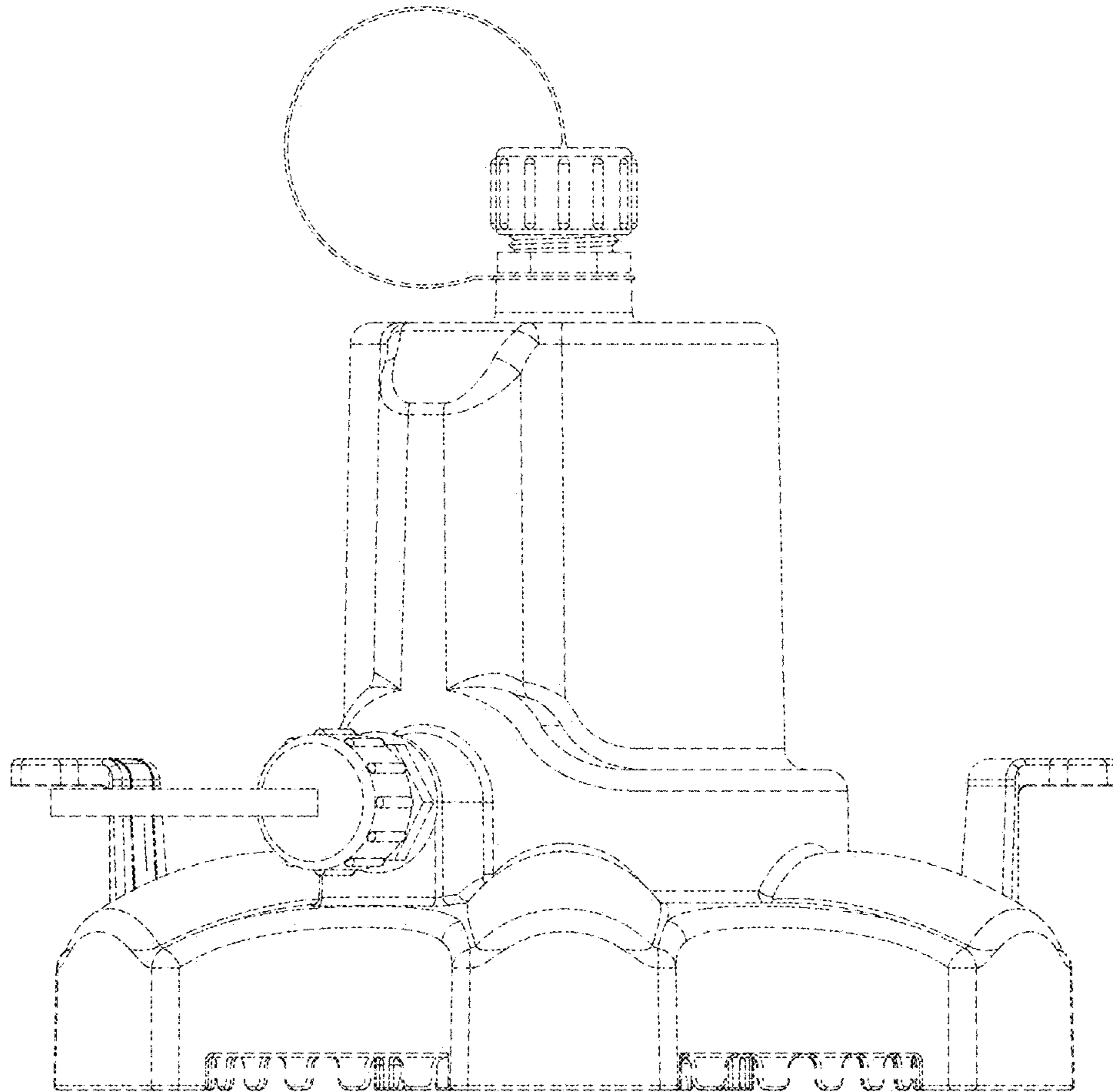

FIG. 18

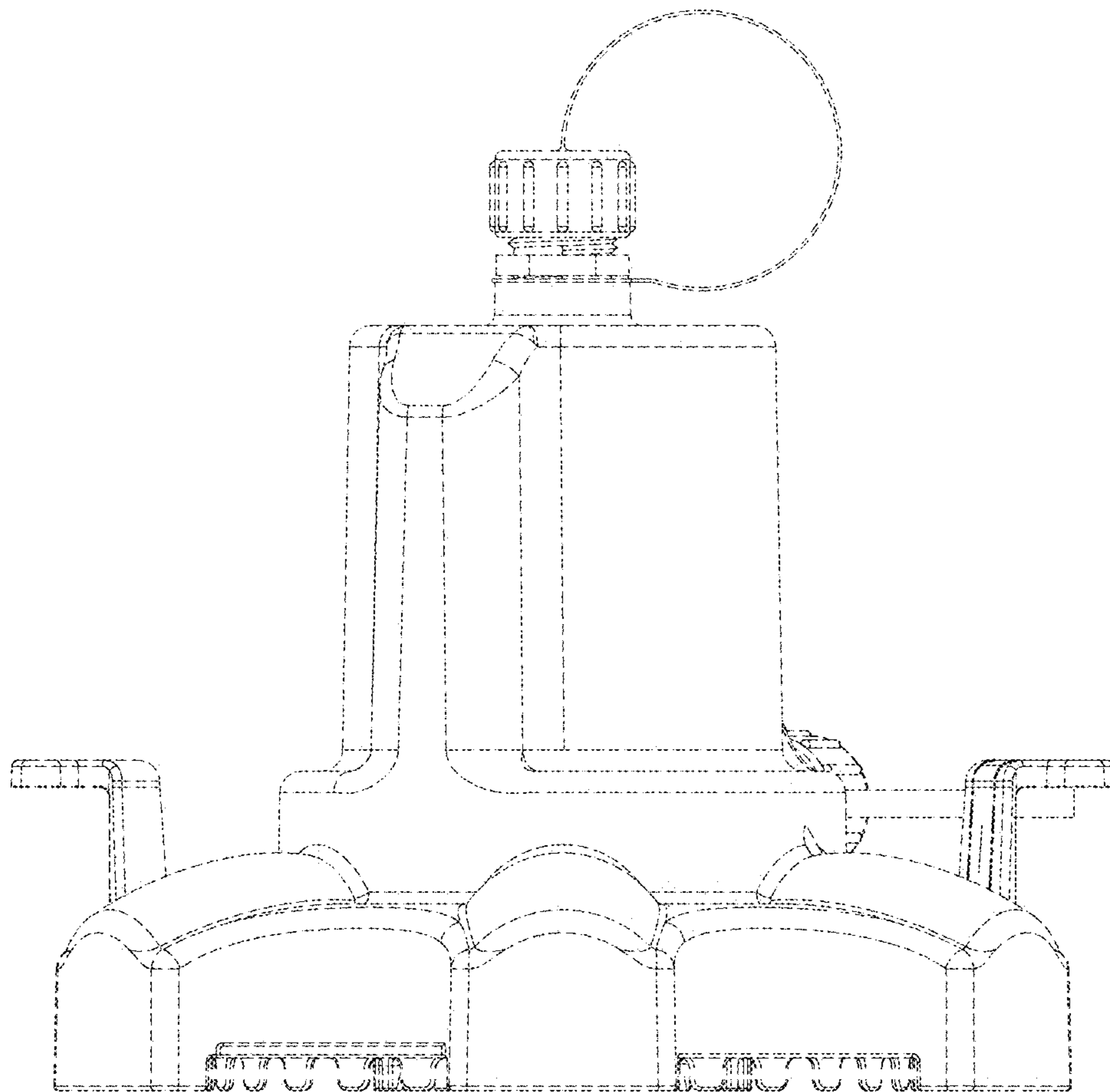

FIG. 19

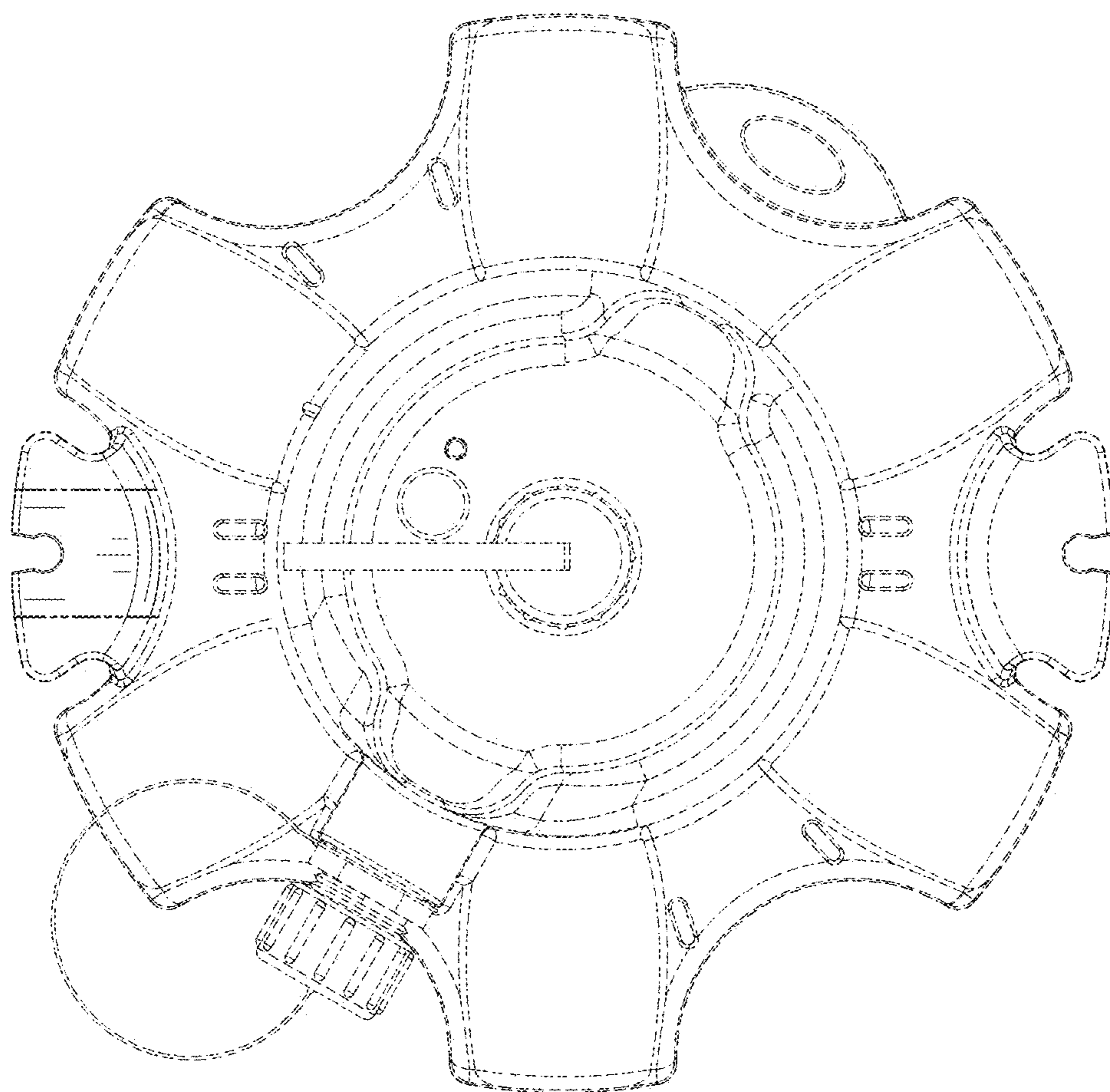

FIG. 20

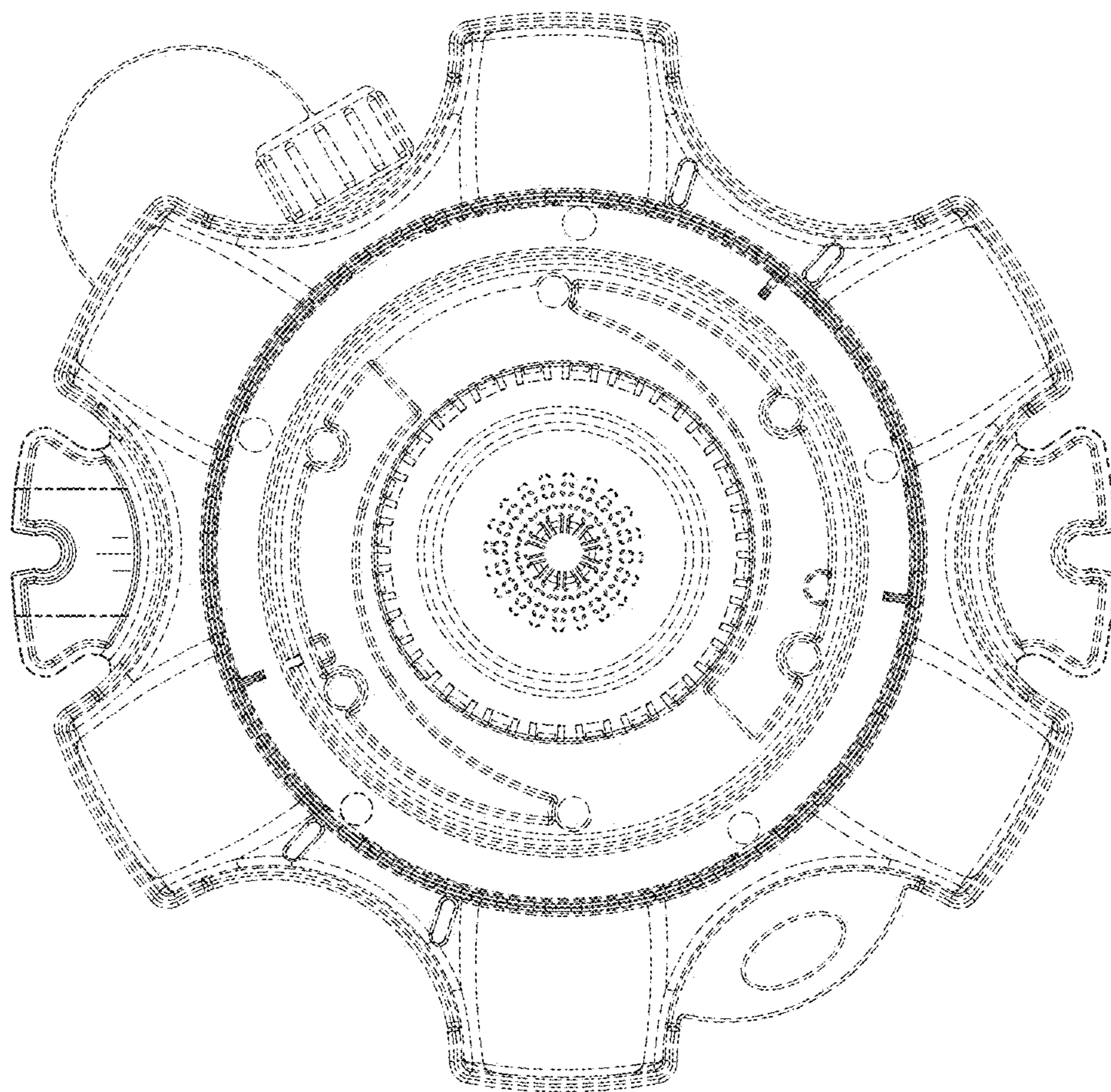

FIG. 21

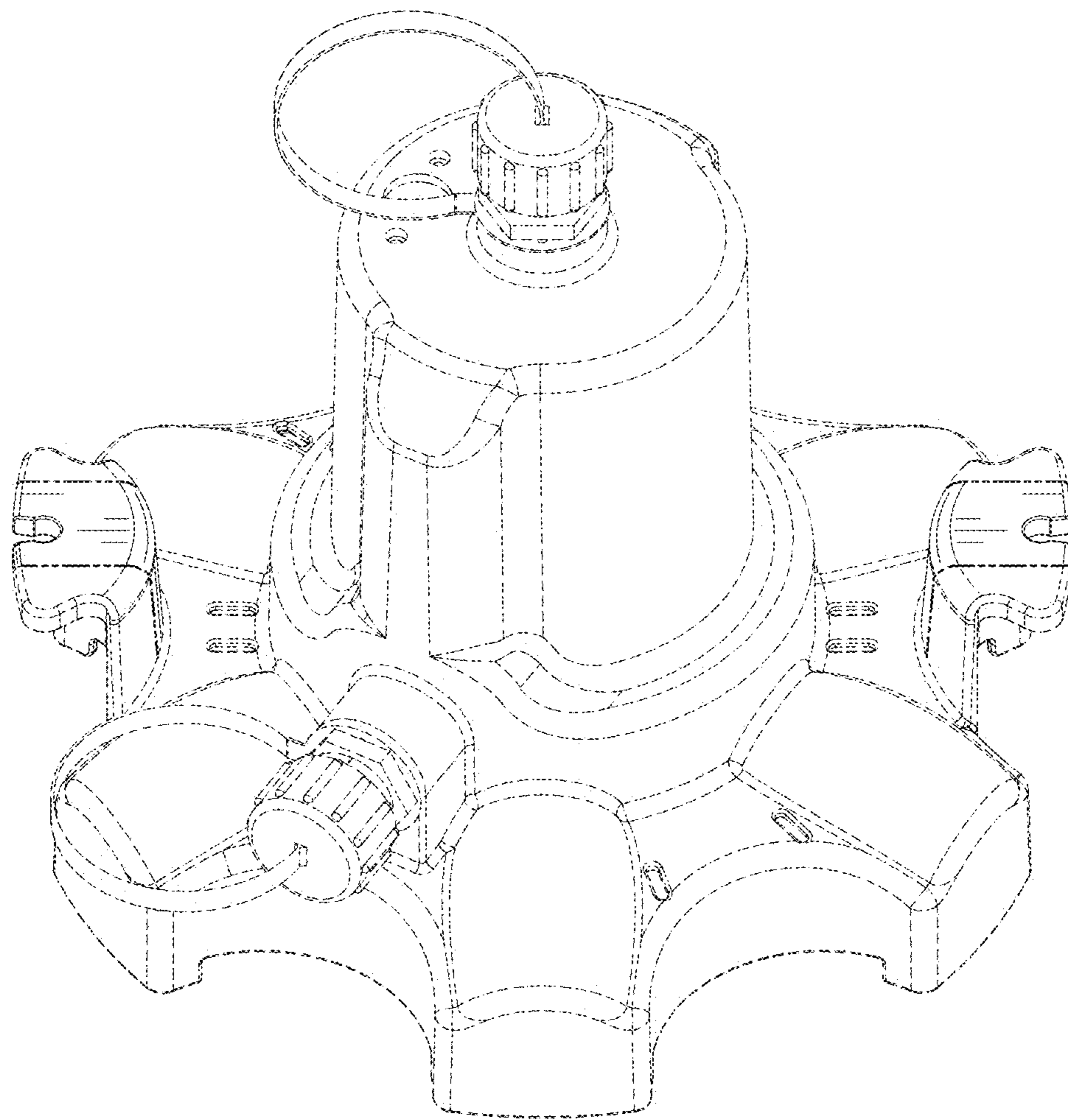

FIG. 22



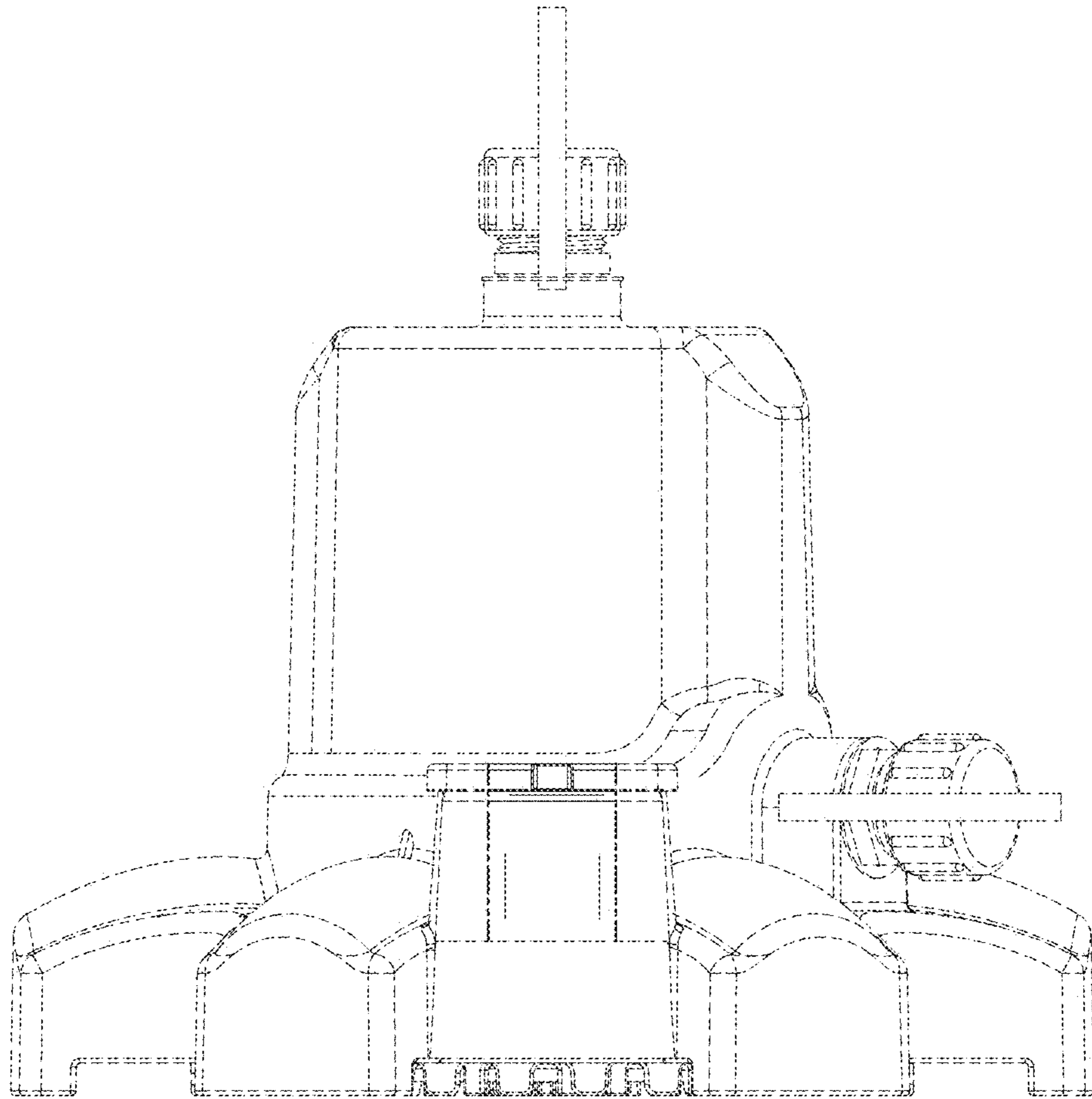

FIG. 23

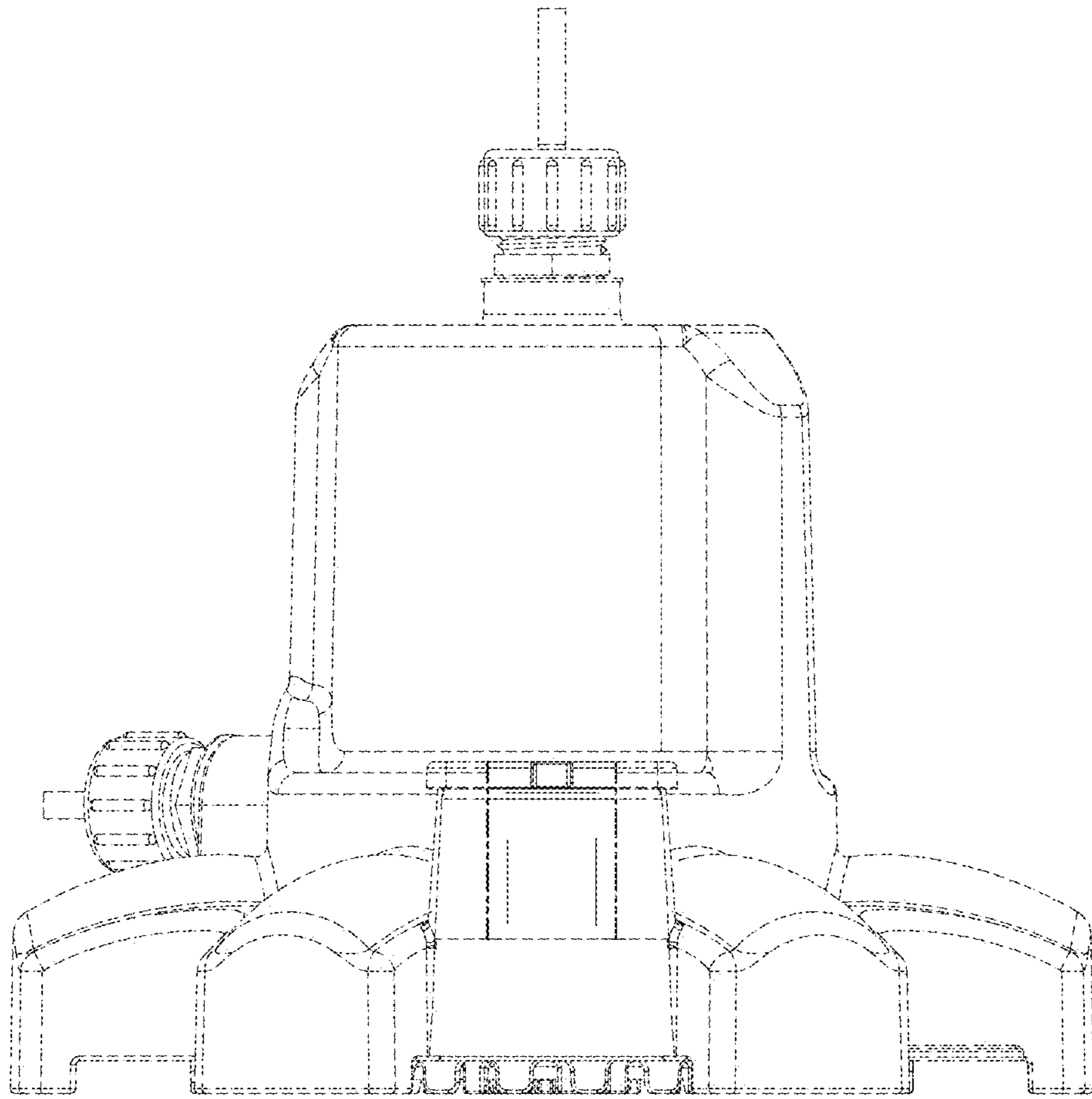

FIG. 24

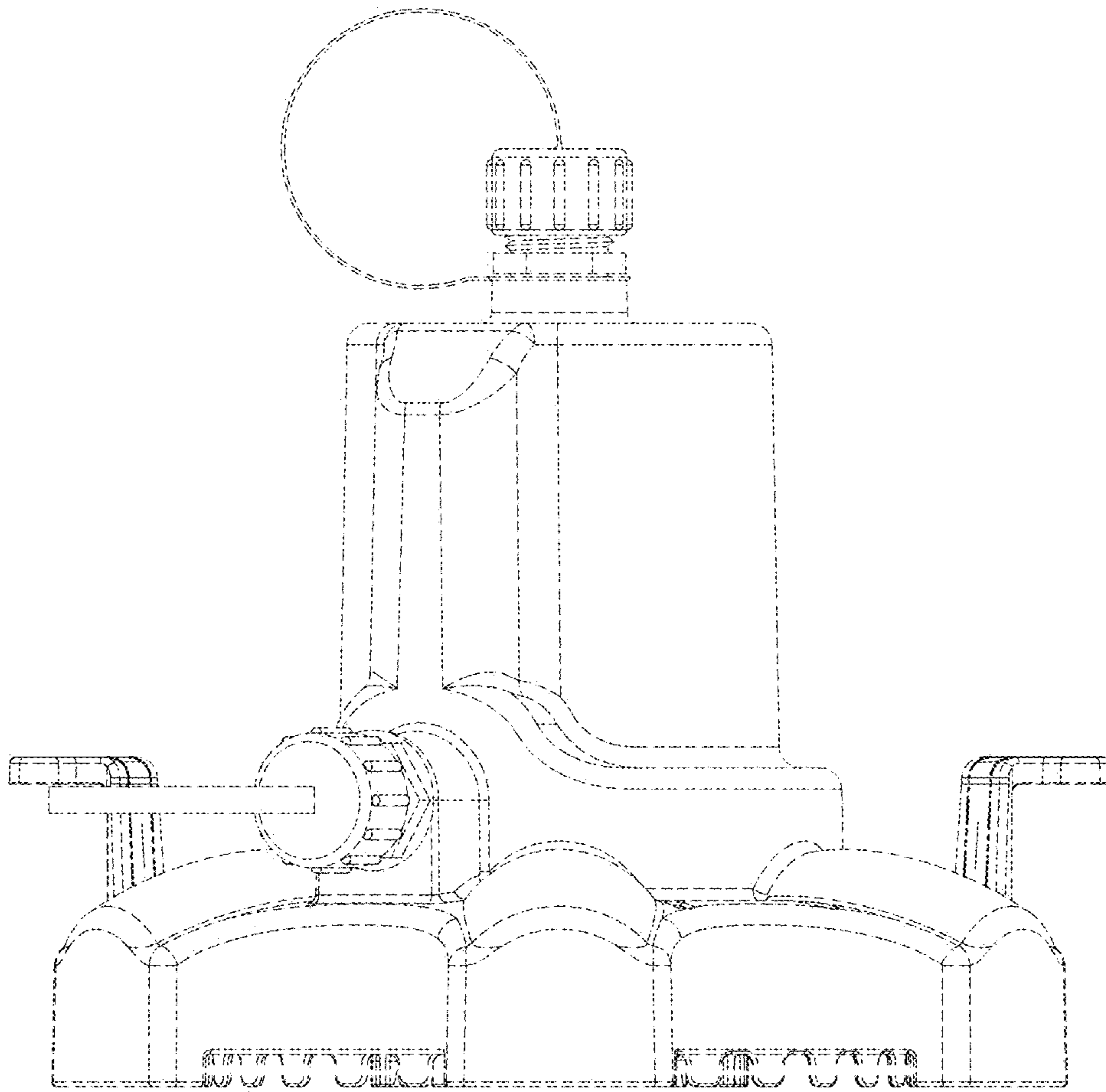

FIG. 25

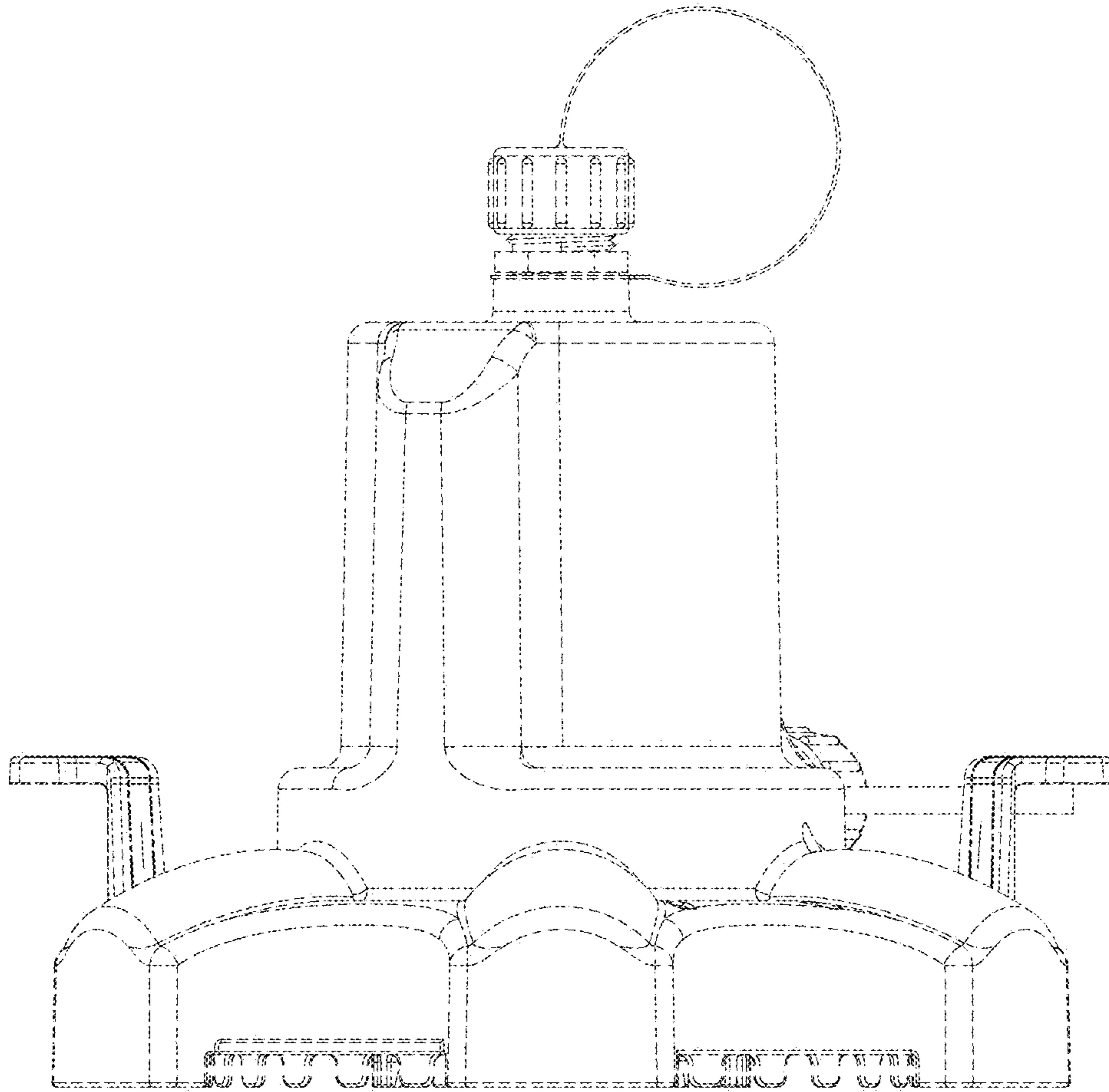

FIG. 26

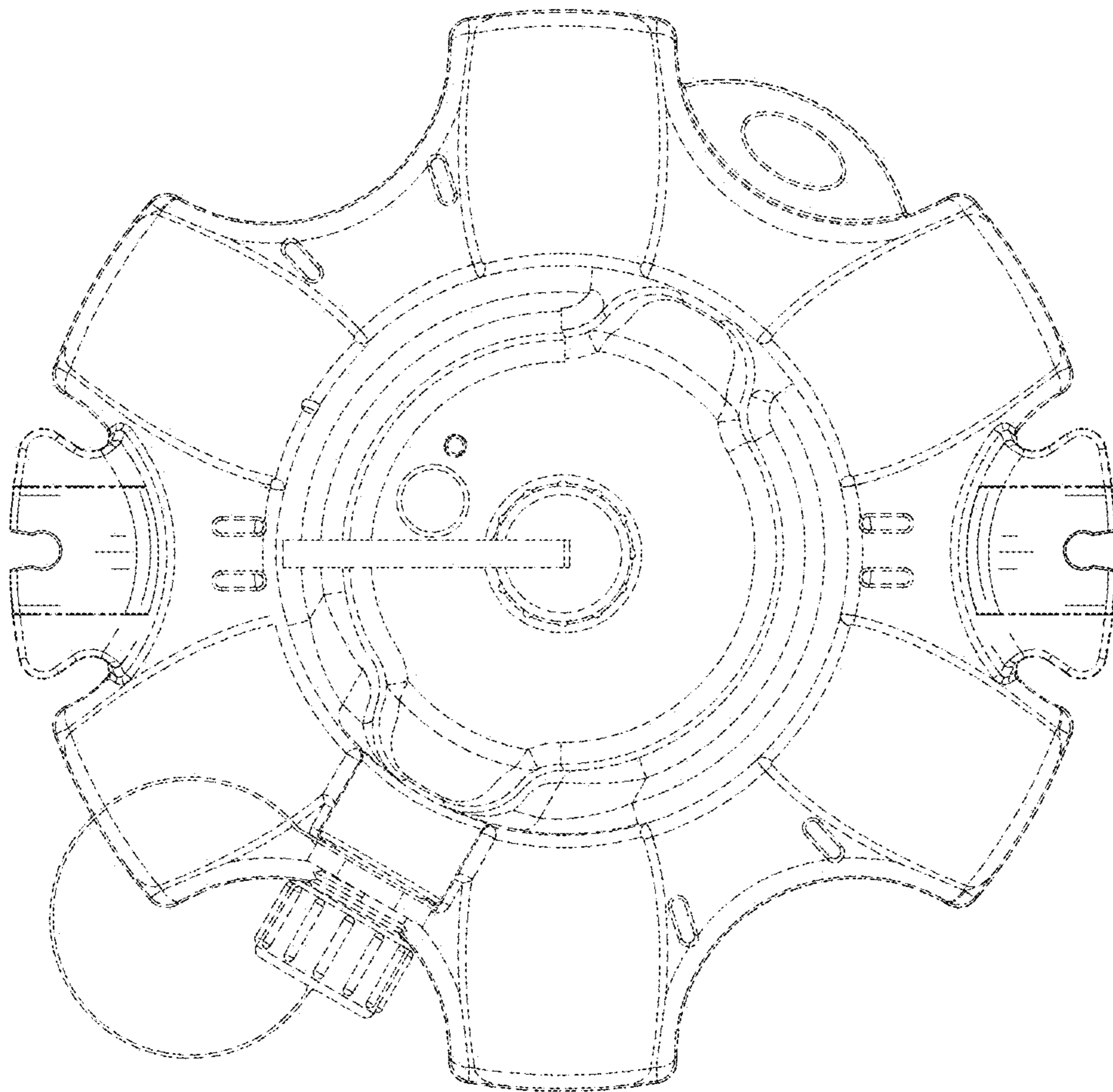

FIG. 27

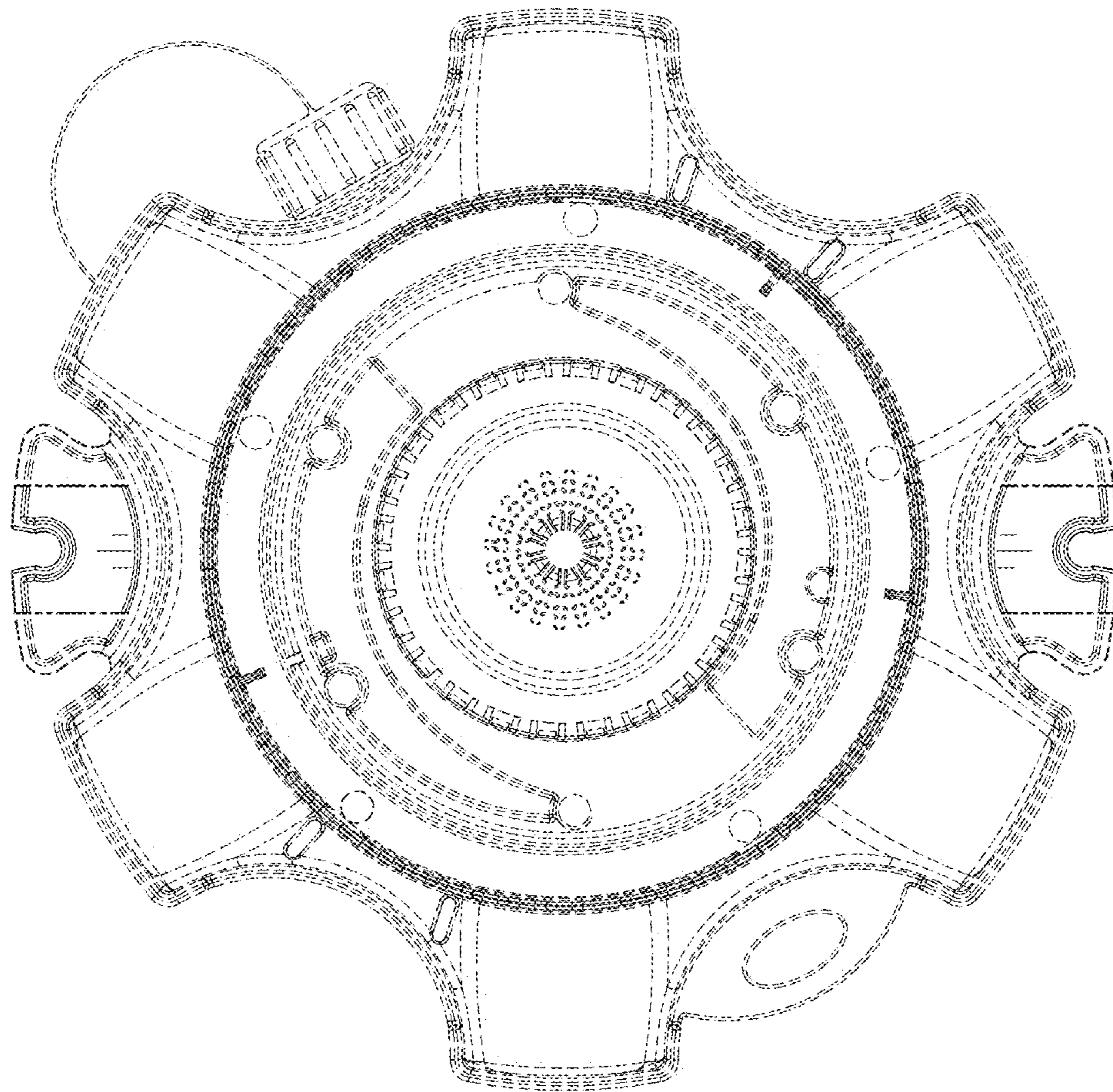

FIG. 28