



US00D916702S

(12) **United States Design Patent**  
**Newsom et al.**

(10) **Patent No.:** **US D916,702 S**  
(45) **Date of Patent:** **\*\* Apr. 20, 2021**

(54) **HEADBAND FOR HEAD-MOUNTED DISPLAY**

(71) Applicant: **Samsung Electronics Co., Ltd.**,  
Suwon-si (KR)

(72) Inventors: **Guy Newsom**, London (GB); **Aleix Ingles Elias**, London (GB)

(73) Assignee: **Samsung Electronics Co., Ltd.**,  
Suwon-si (KR)

(\*\*) Term: **15 Years**

(21) Appl. No.: **29/674,042**

(22) Filed: **Dec. 19, 2018**

(30) **Foreign Application Priority Data**

Jul. 4, 2018 (KR) ..... 30-2018-0030924

(51) **LOC (13) Cl.** ..... **14-02**

(52) **U.S. Cl.**  
USPC ..... **D14/372**

(58) **Field of Classification Search**  
USPC ..... D14/372, 496, 432, 371, 125, 126, 129,  
D14/299; D16/300-342; 351/158, 153,  
(Continued)

(56) **References Cited**

U.S. PATENT DOCUMENTS

D771,625 S 11/2016 Sullivan et al.  
D810,743 S \* 2/2018 Yee ..... D14/372  
(Continued)

FOREIGN PATENT DOCUMENTS

CN 201630000036X 7/2016  
EM 004029502-0001 6/2017  
KR 30-2017-0047891 6/2018

*Primary Examiner* — Austin Murphy

(74) *Attorney, Agent, or Firm* — NSIP Law

(57) **CLAIM**

We claim the ornamental design for a headband for head-mounted display, as shown and described.

**DESCRIPTION**

FIG. 1 is a front perspective view of a headband for head-mounted display showing our new design;  
FIG. 2 is a front view thereof;  
FIG. 3 is a rear view thereof;  
FIG. 4 is a left-side view thereof;  
FIG. 5 is a right-side view thereof;  
FIG. 6 is a top view thereof;  
FIG. 7 is a bottom view thereof;  
FIG. 8 is a front perspective view thereof shown with a first example head-mounted display attached;  
FIG. 9 is a front perspective view thereof shown with a second example head-mounted display attached;  
FIG. 10 is a right-side view thereof shown with a third example head-mounted display attached in a first position;  
FIG. 11 is a right-side view thereof shown with a fourth example head-mounted display attached in a second position;  
FIG. 12 is a right-side view thereof shown with a fifth example head-mounted display attached in a third position;  
FIG. 13 is an enlarged view of the portion encircled in FIG. 1;  
FIG. 14 is an enlarged view of the portion encircled in FIG. 2;  
FIG. 15 is an enlarged view of the portion encircled in FIG. 3;  
FIG. 16 is an enlarged view of the portion encircled in FIG. 4;  
FIG. 17 is an enlarged view of the portion encircled in FIG. 6;  
FIG. 18 is an enlarged view of the portion encircled in FIG. 7;  
FIG. 19 is an enlarged view of the portion encircled in FIG. 9; and,  
FIG. 20 is an enlarged view of the portion encircled in FIG. 12.

The broken lines in the figures depict portions of the headband for head-mounted display which form no part of the claimed design. The broken lines in FIGS. 8 through 12,

(Continued)

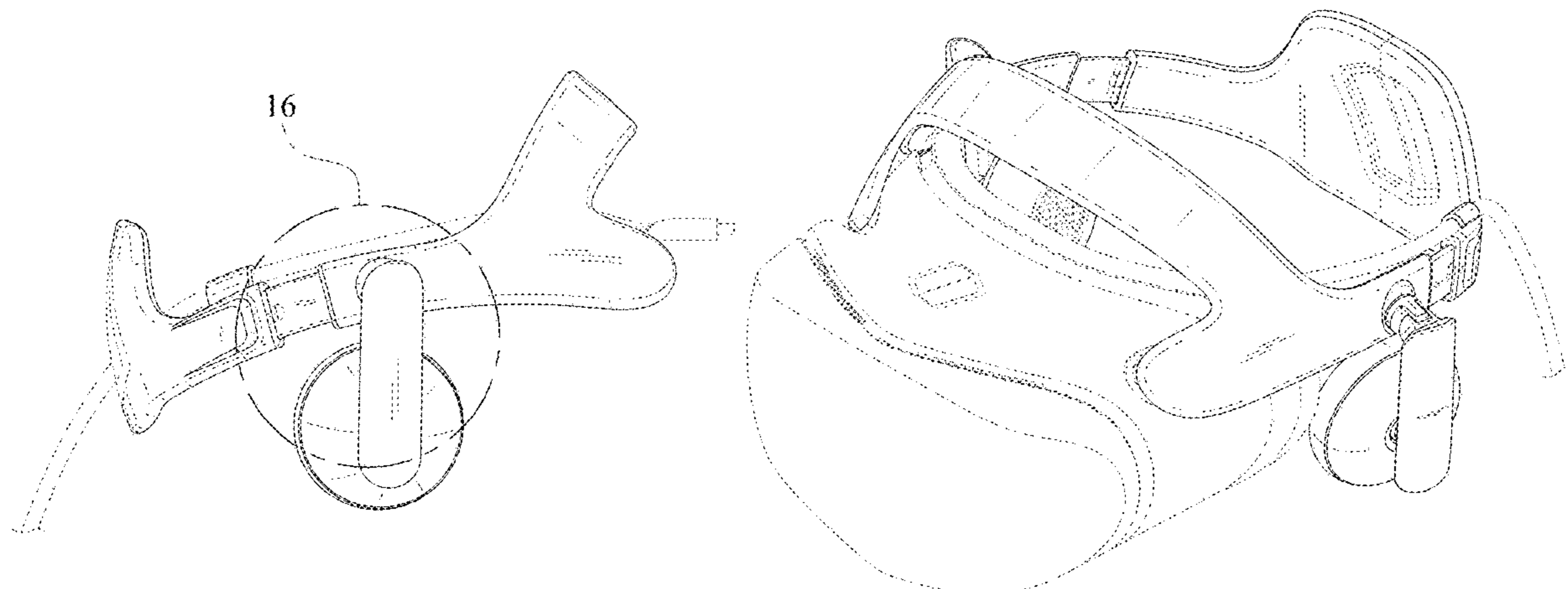

**19** and **20** which depict the example head-mounted display are for environmental purposes only, and form no part of the claimed design.

The dot-dash broken lines encircling portions of the claimed design that are illustrated in enlargements form no part of the claimed design.

**1 Claim, 20 Drawing Sheets**

(58) **Field of Classification Search**

USPC ..... 351/144; 345/7-9, 905; 455/344;  
348/115, 53, 121, 739  
CPC ..... G02B 27/017; G02B 27/0158; G02B  
27/0161; G02B 27/0181; G02B 27/0185;  
G02B 27/0189

See application file for complete search history.

(56) **References Cited**

U.S. PATENT DOCUMENTS

D819,635	S	*	6/2018	Miller	.....	D14/372
D827,642	S	*	9/2018	Liu	.....	D14/372
D834,018	S	*	11/2018	Wei	.....	D14/372
D838,719	S	*	1/2019	Wei	.....	D14/372
D839,871	S	*	2/2019	Wei	.....	D14/372
D839,872	S	*	2/2019	Wei	.....	D14/372
D856,330	S	*	8/2019	Wei	.....	D14/372
D877,148	S	*	3/2020	Wei	.....	D14/372
D882,568	S	*	4/2020	Park	.....	D14/372
D883,980	S	*	5/2020	Chen	.....	D14/372

\* cited by examiner

FIG. 1

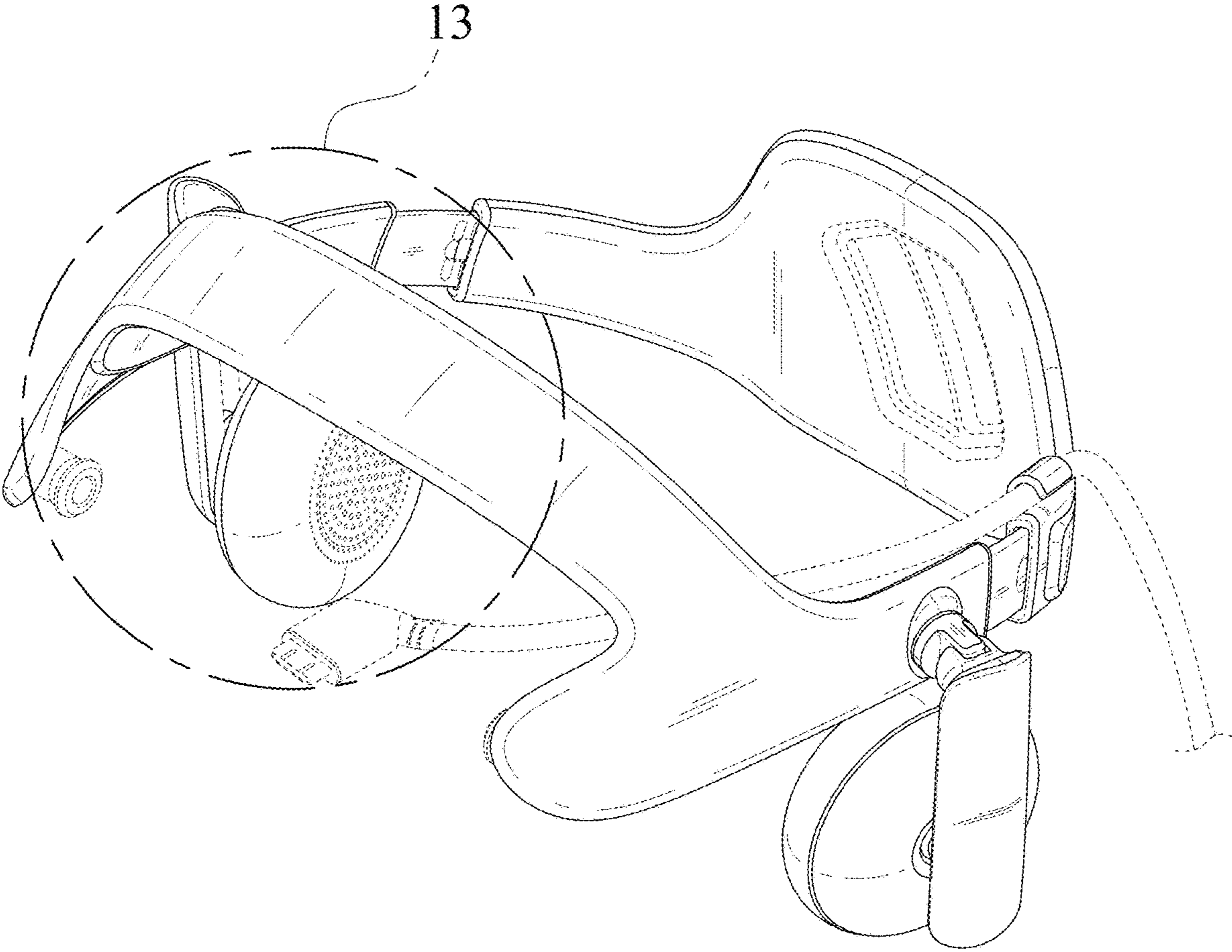

FIG. 2

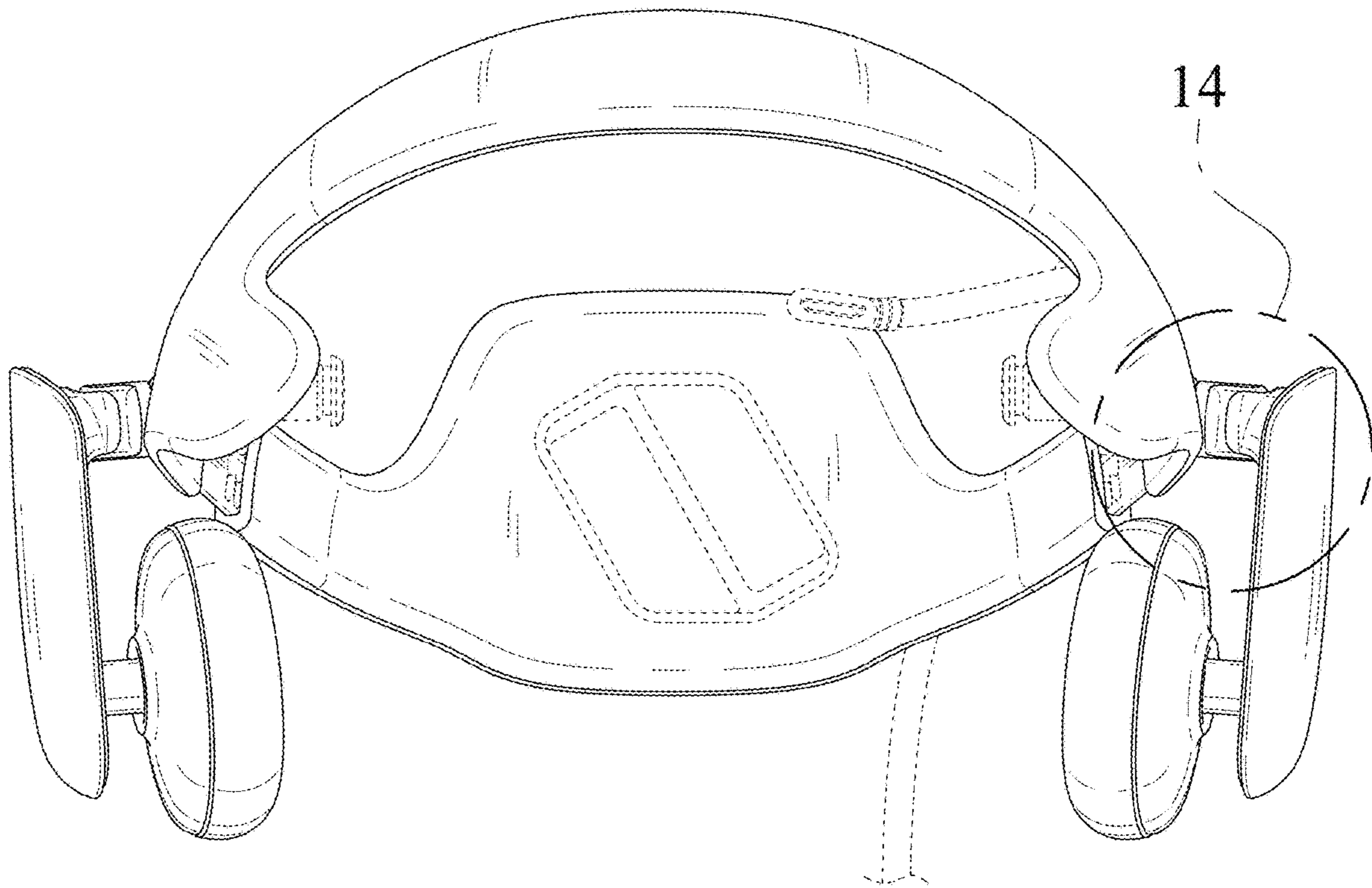

FIG. 3

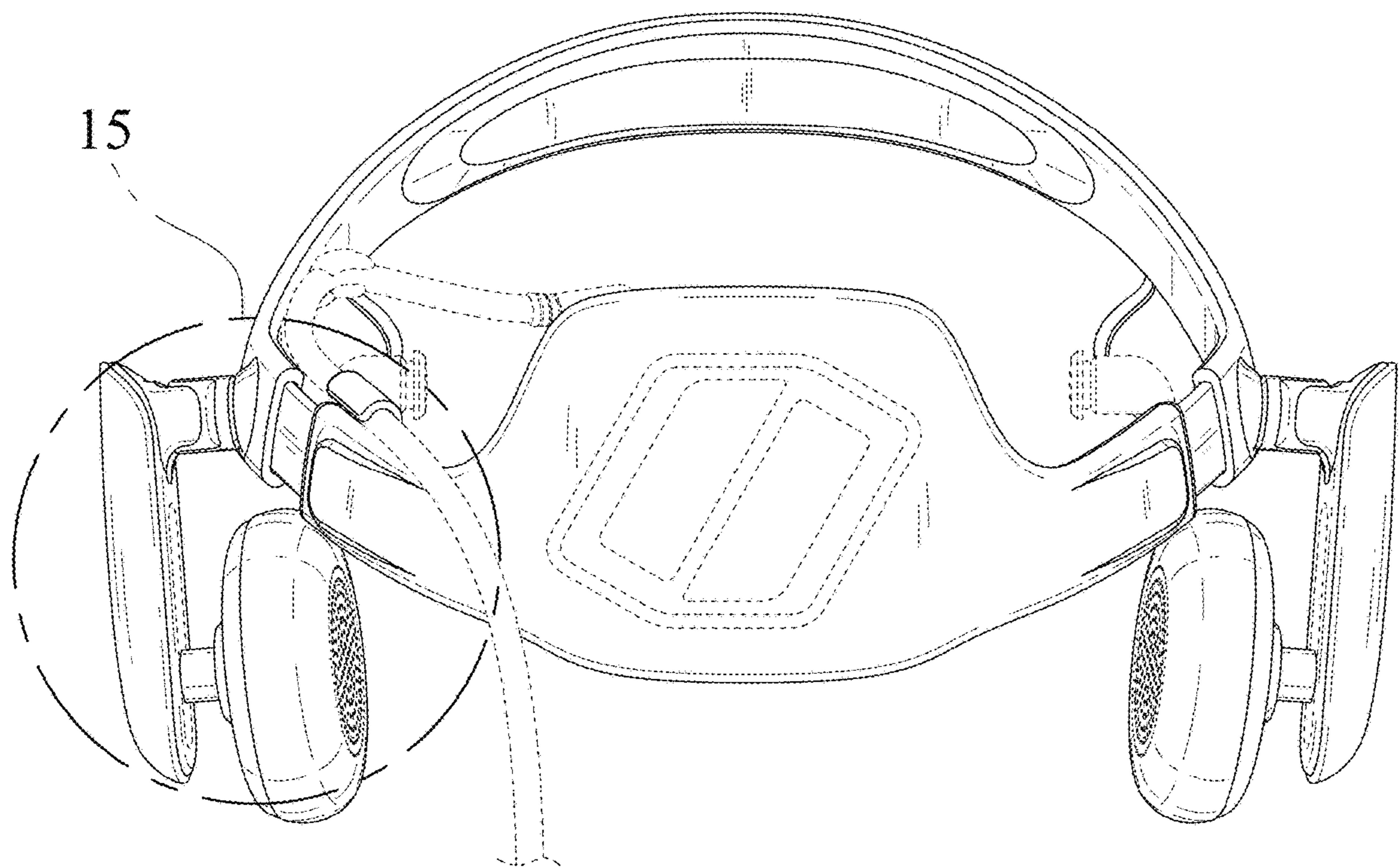

FIG. 4

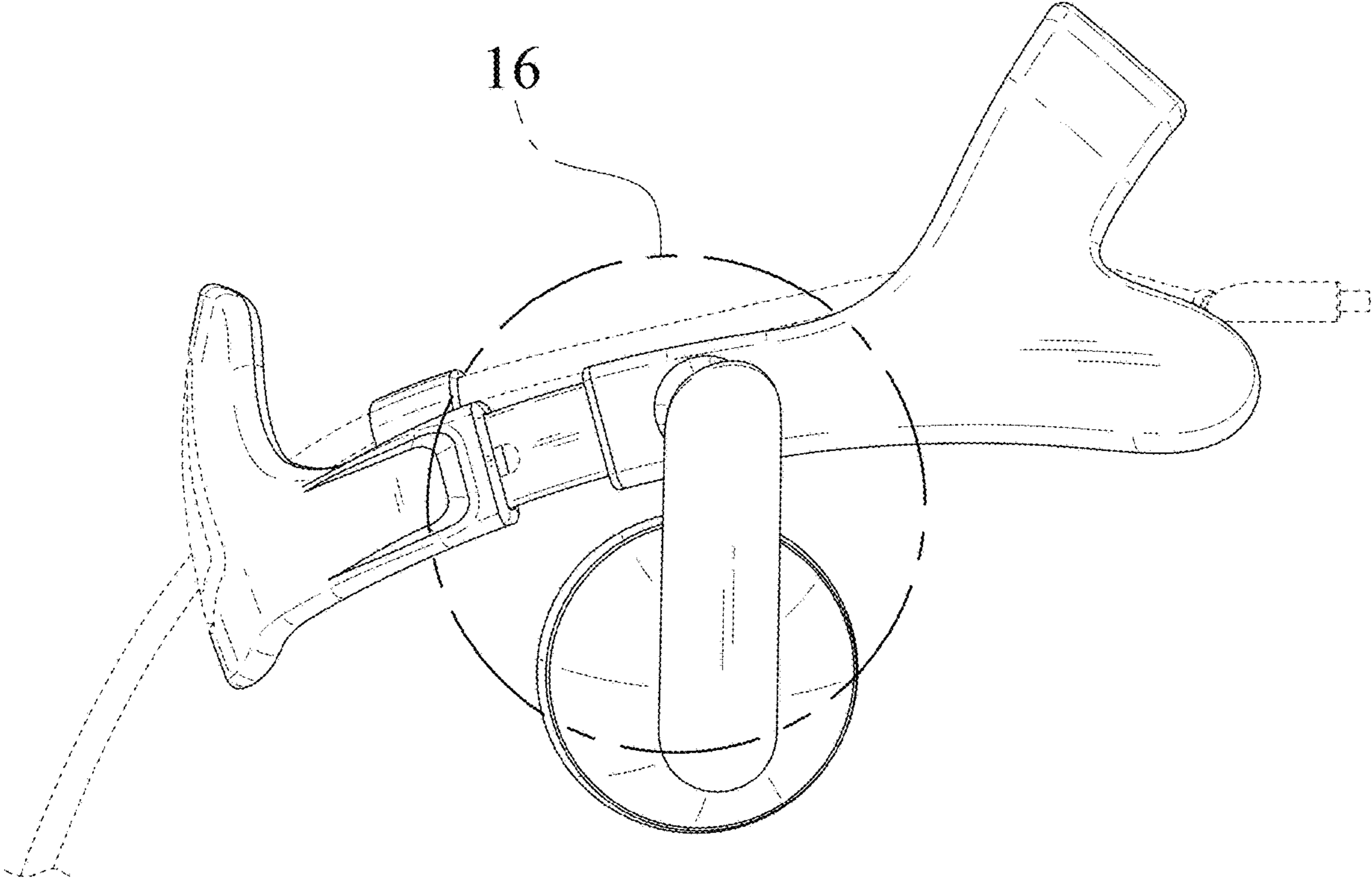

FIG. 5

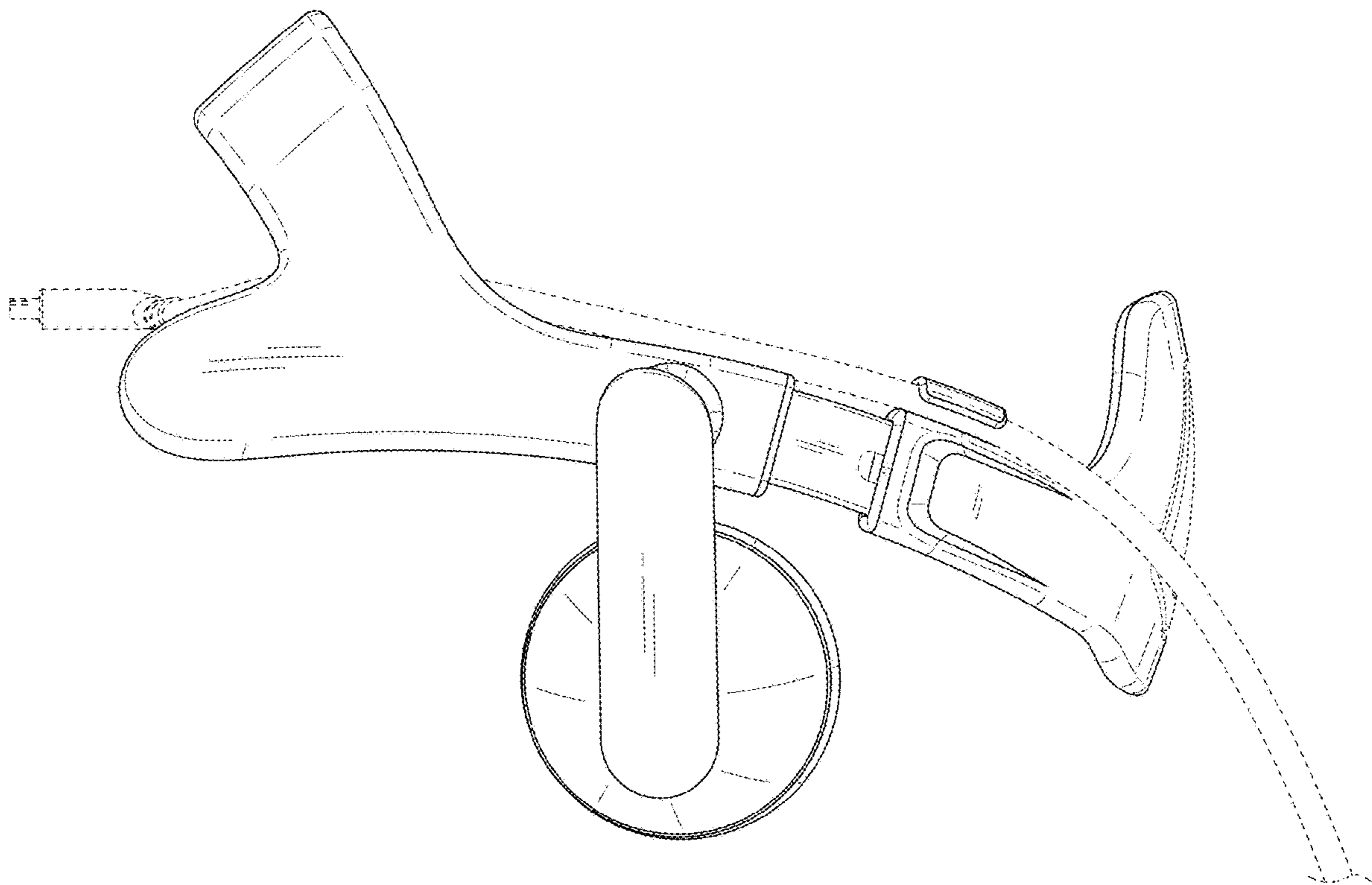

FIG. 6

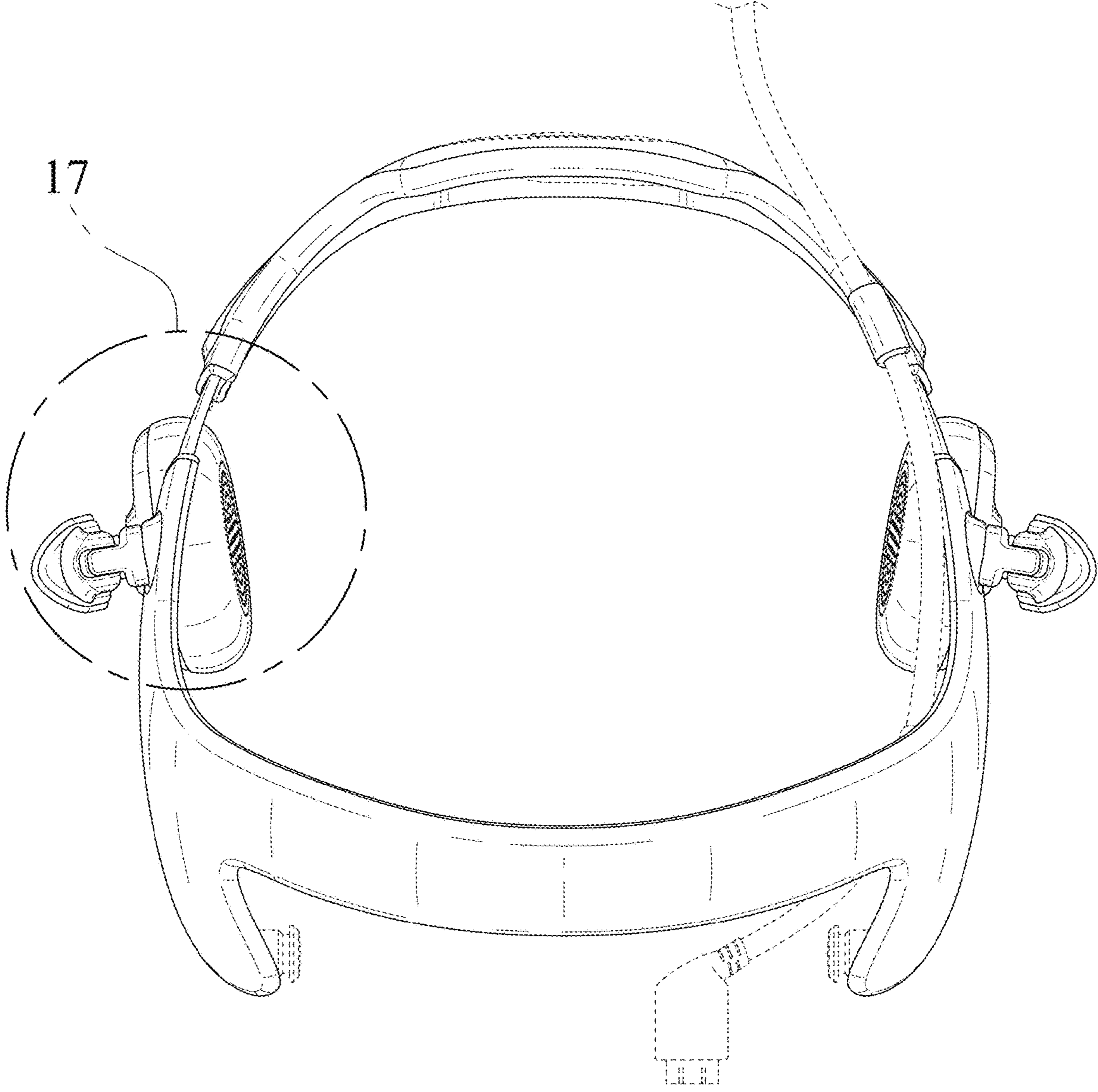



FIG. 7

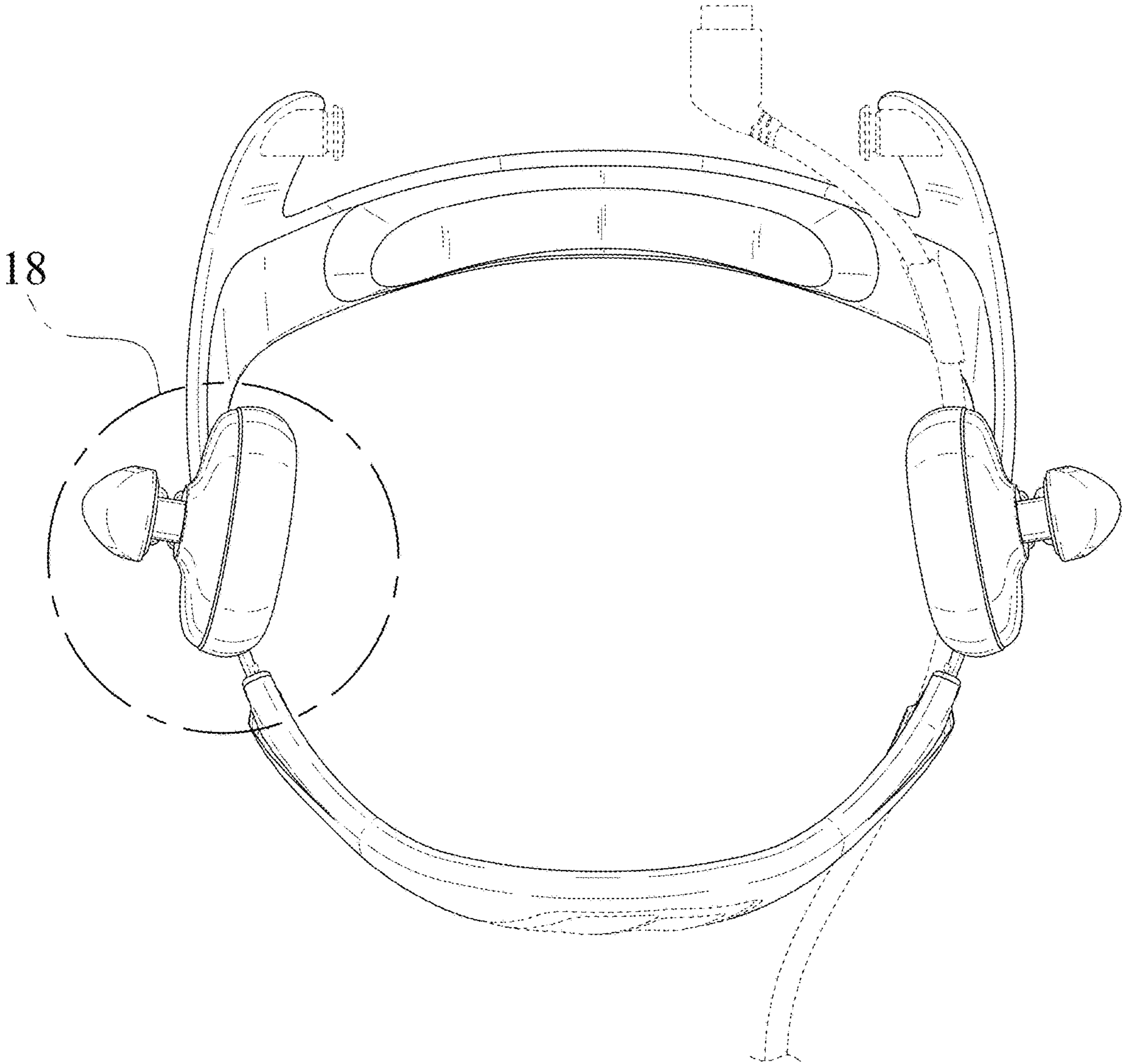

FIG. 8

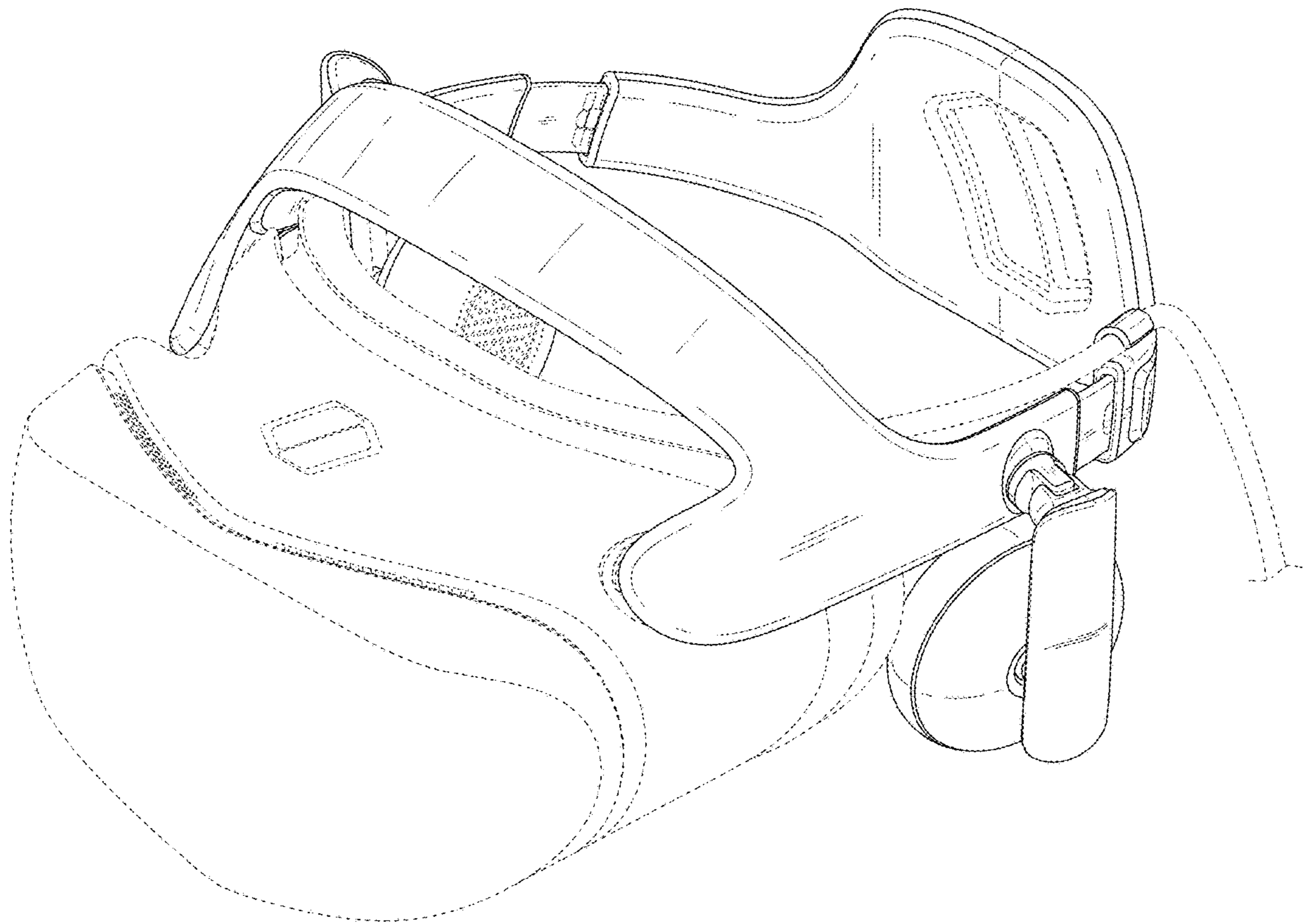

FIG. 9

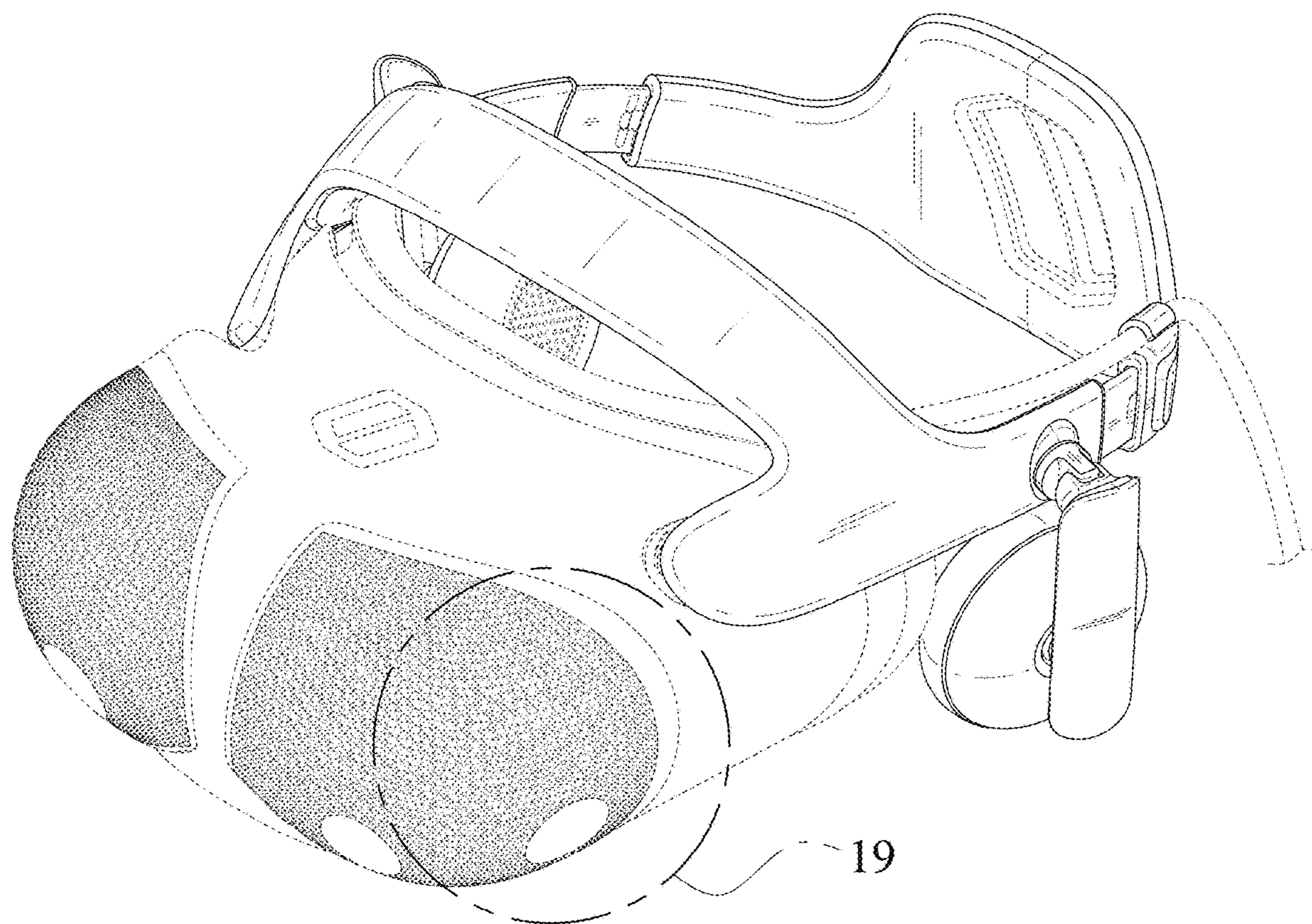

FIG. 10

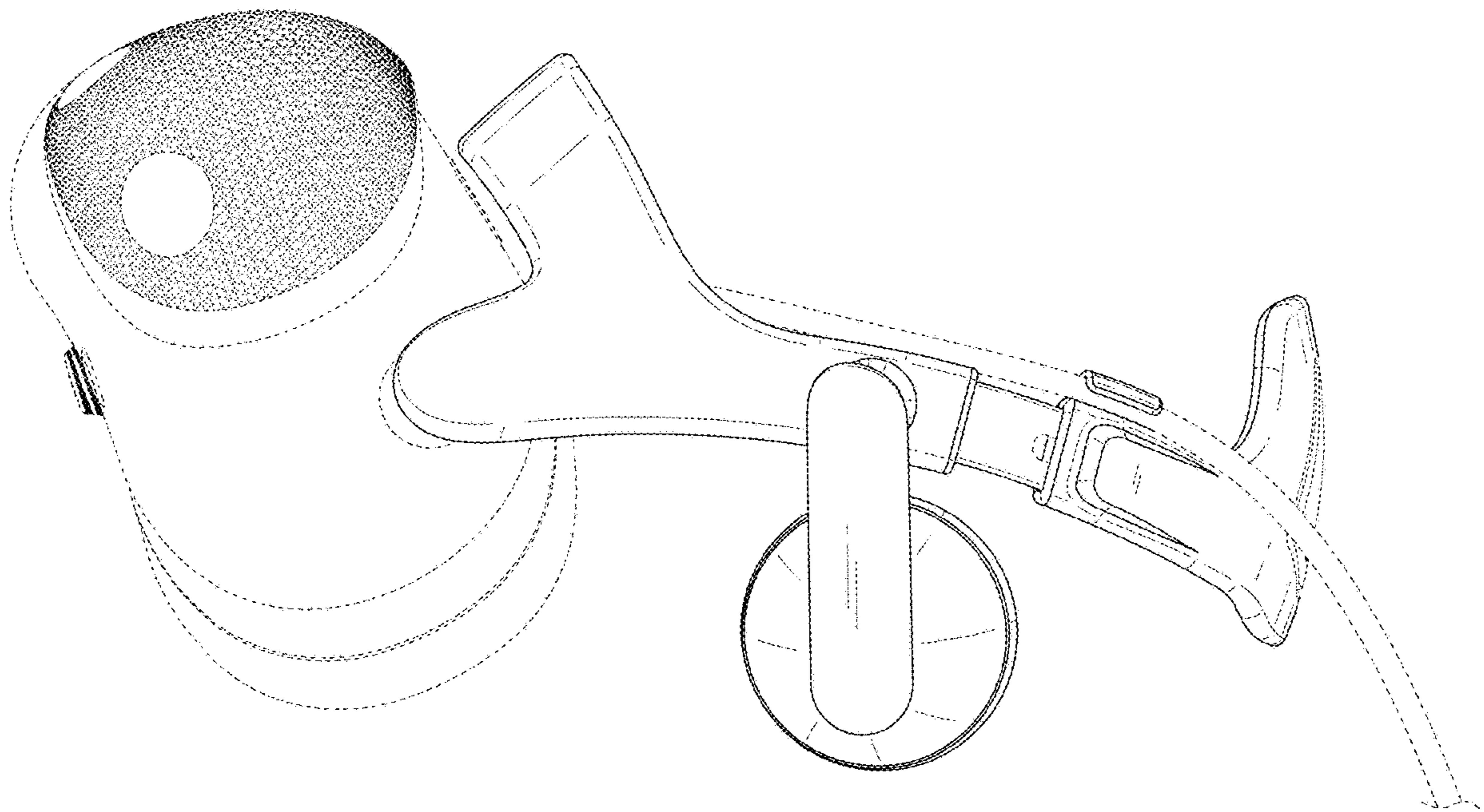

FIG. 11

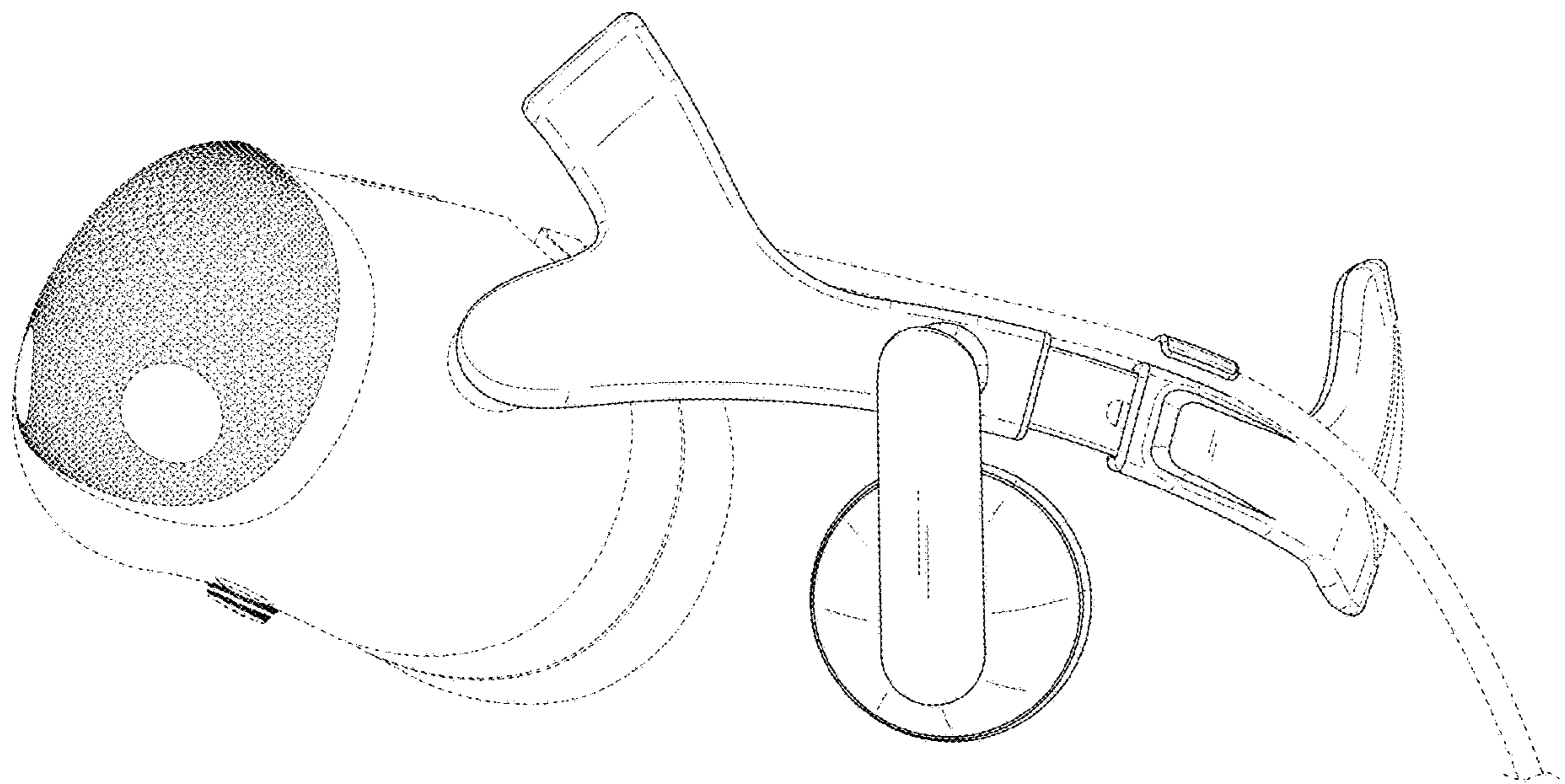

FIG. 12

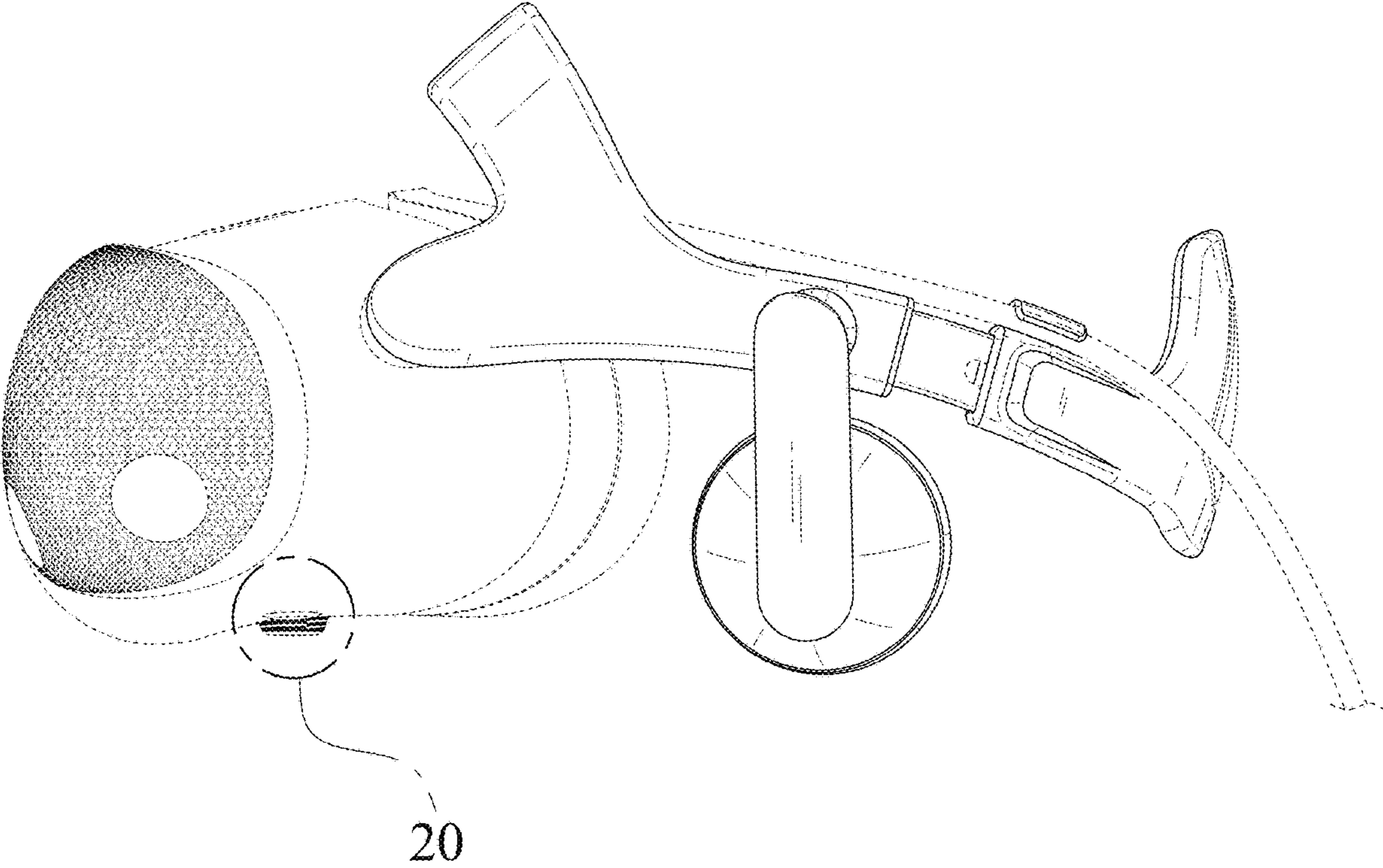

FIG. 13

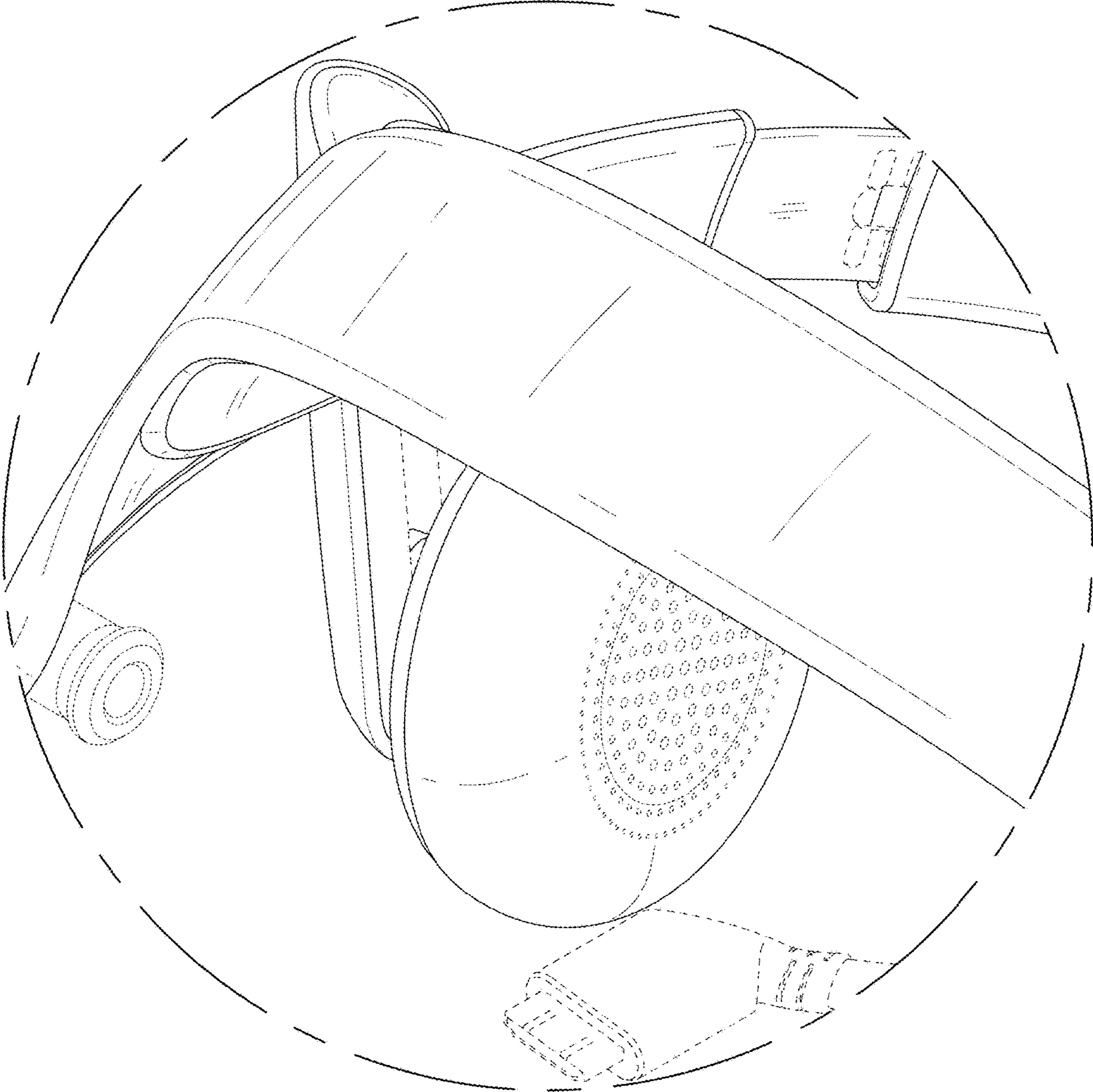

FIG. 14

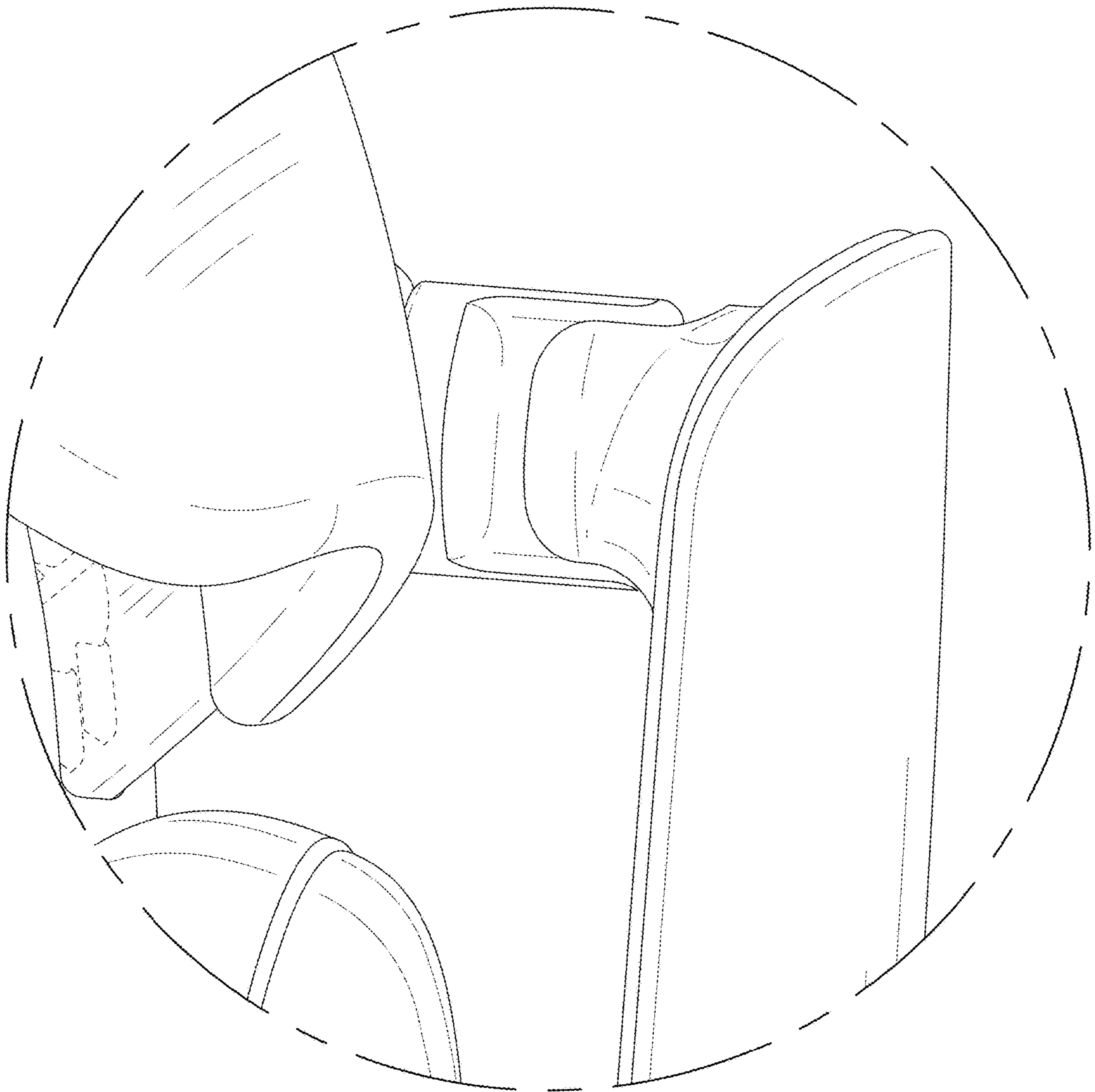



FIG. 15

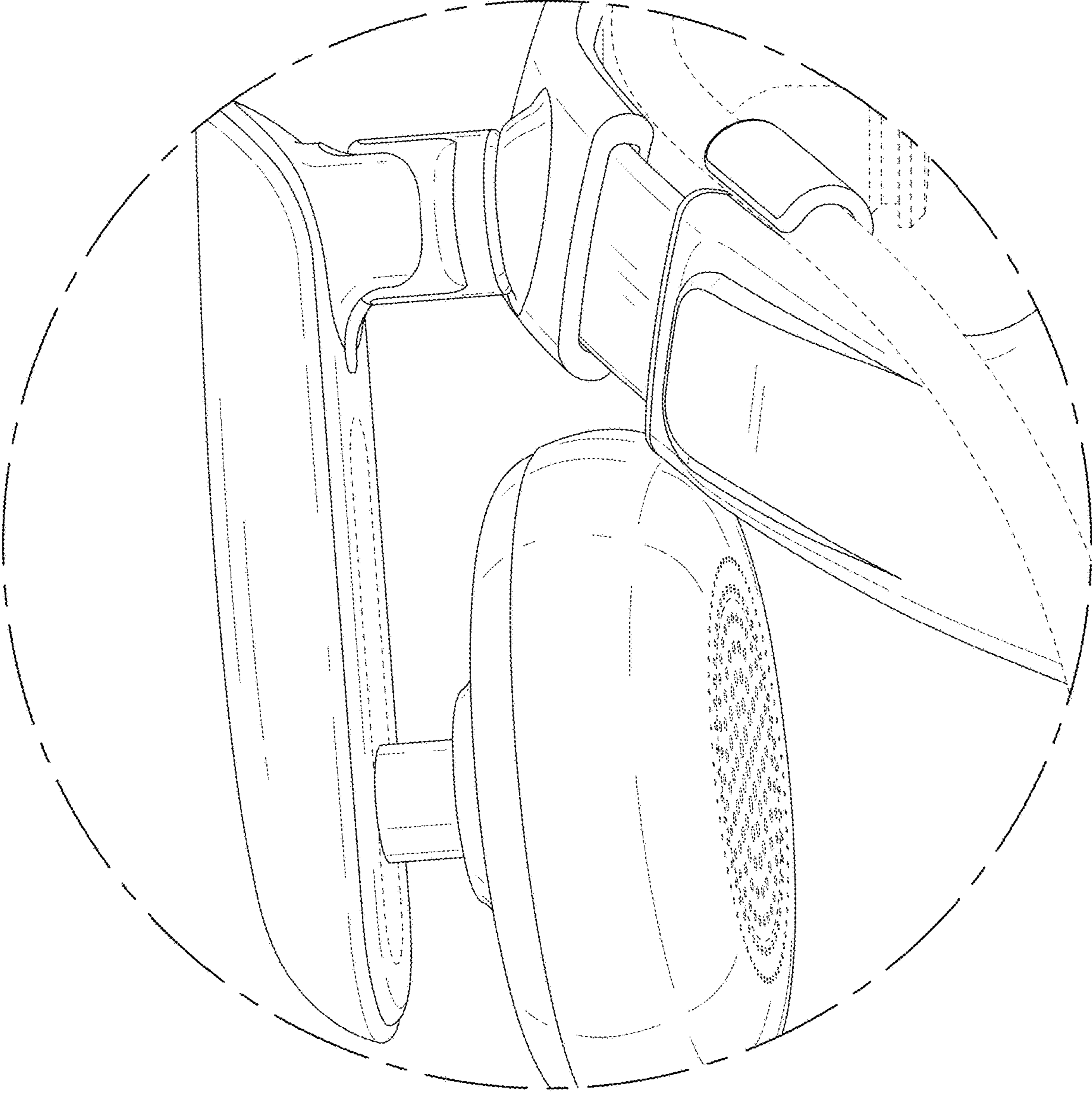

FIG. 16

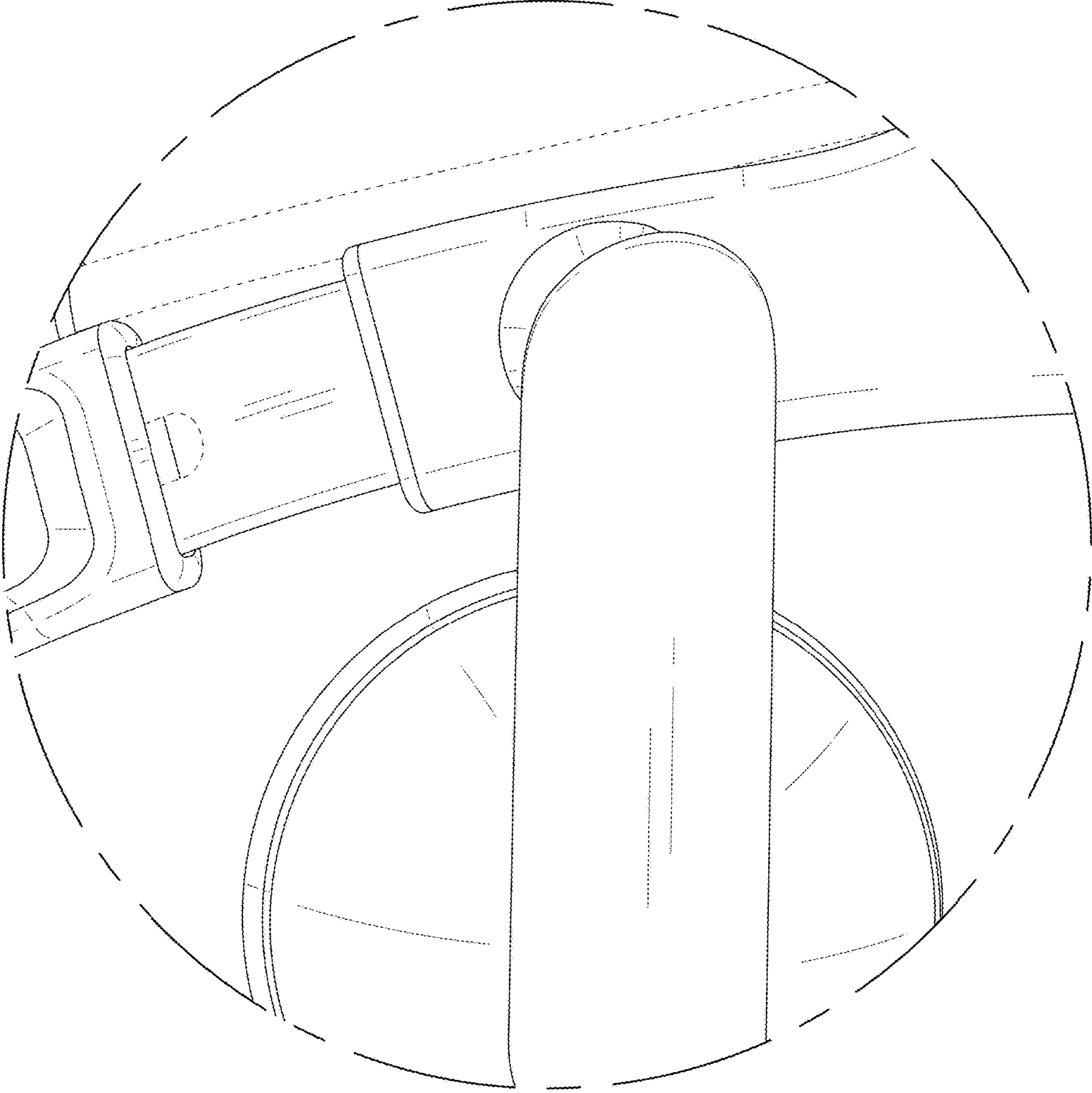

FIG. 17

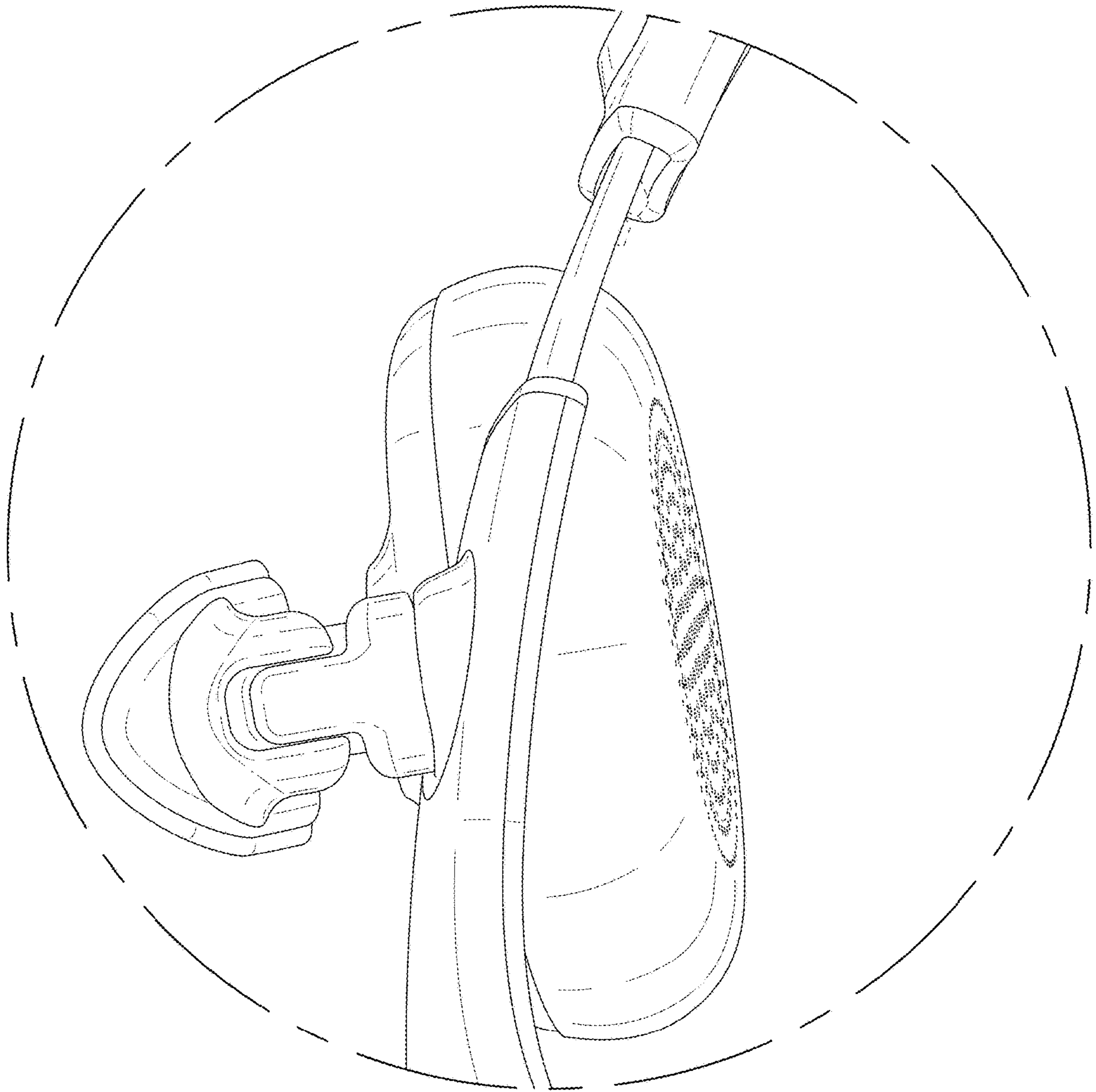

FIG. 18

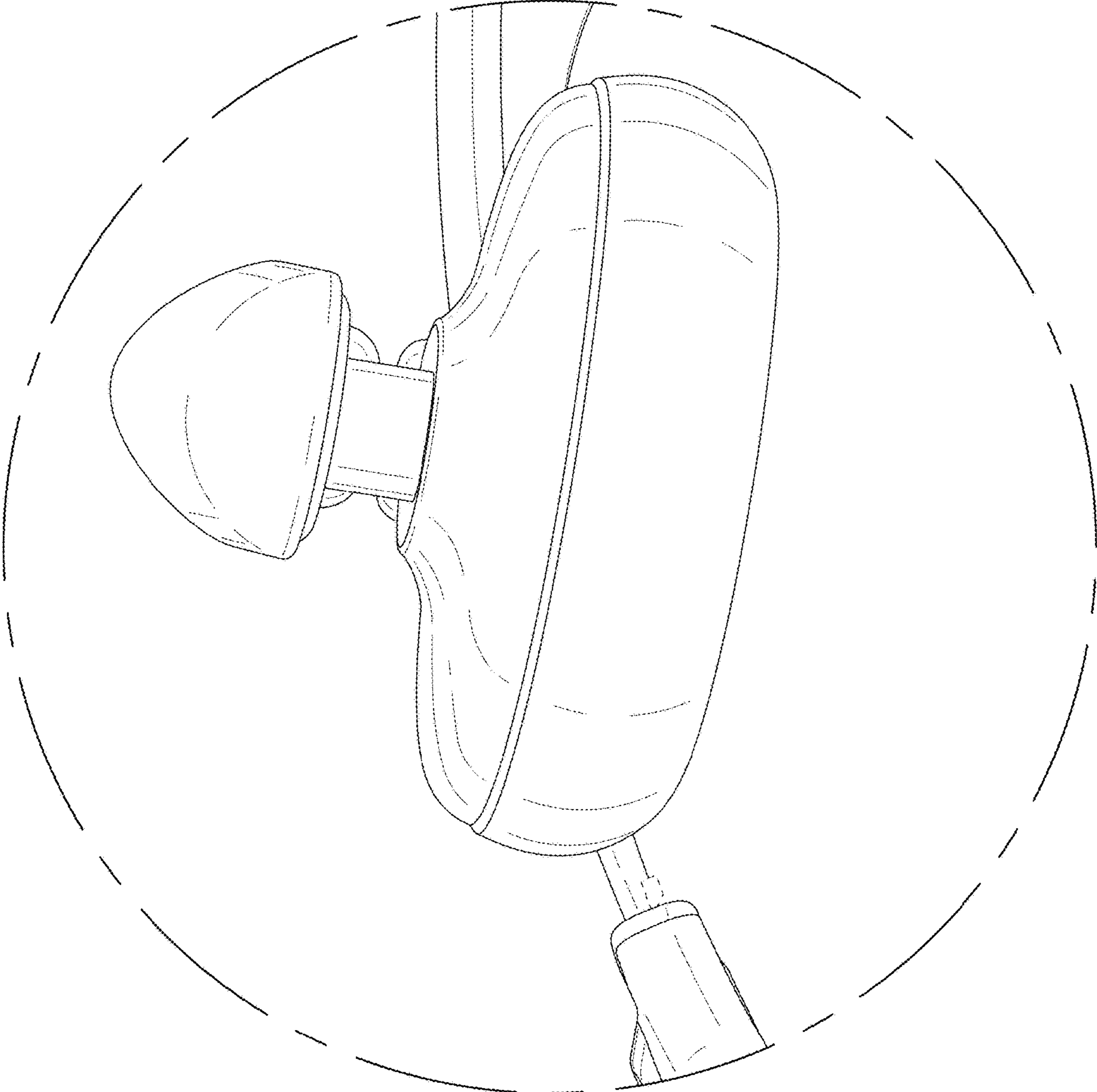

FIG. 19

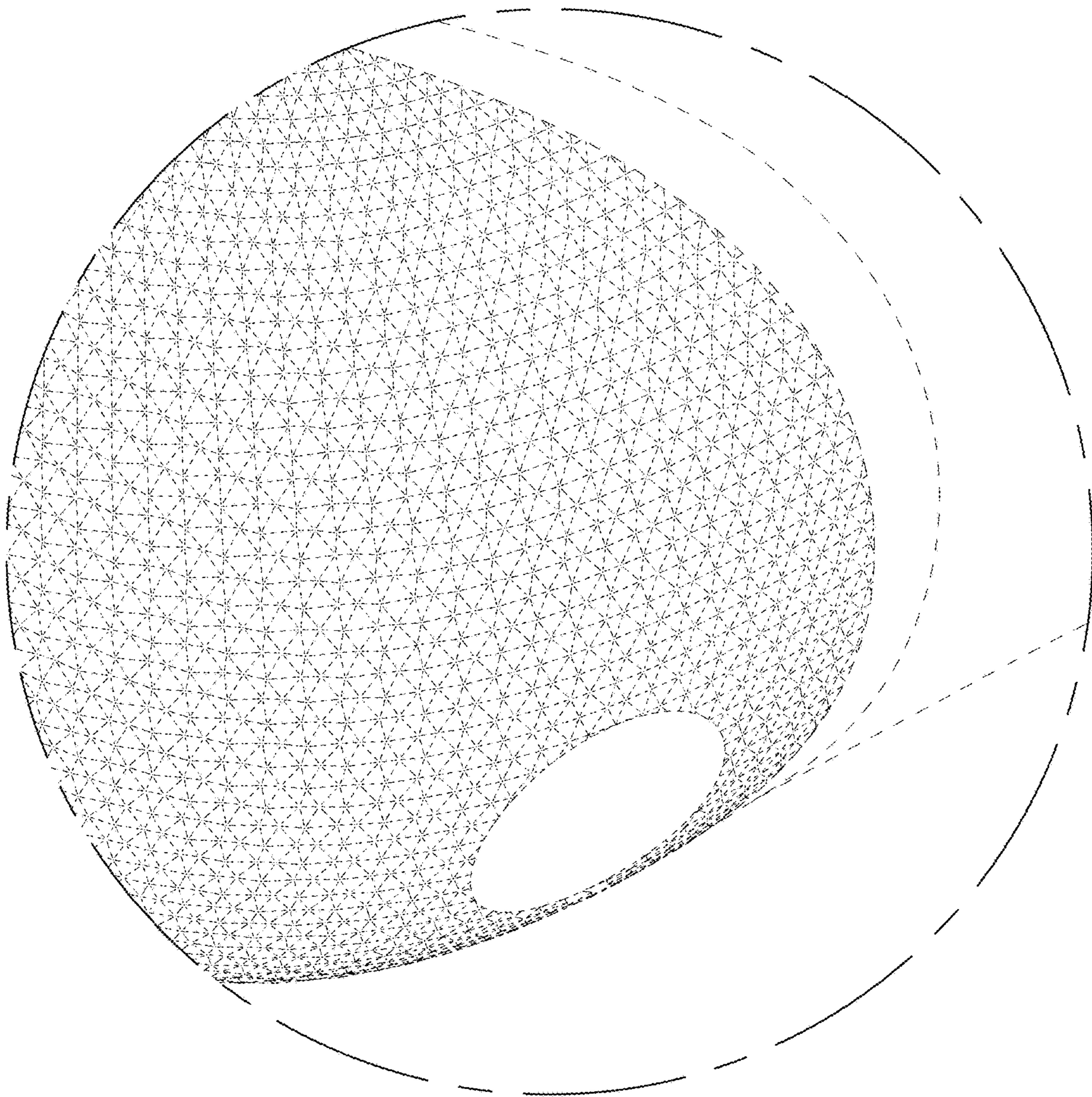

FIG. 20

