



US00D916597S

(12) **United States Design Patent** (10) **Patent No.:** **US D916,597 S**
Brennan (45) **Date of Patent:** **** Apr. 20, 2021**

(54) **DISPENSER**

FOREIGN PATENT DOCUMENTS

(71) Applicant: **Design Pac International, Inc.**,
Carrollton, TX (US)
(72) Inventor: **Timothy Brennan**, Carrollton, TX (US)
(**) Term: **15 Years**
(21) Appl. No.: **29/701,430**

CN 3369563 * 5/2004
CN 301837870 * 2/2012
CN 304775355 * 8/2018
KR 300387082.0000 * 7/2005
KR 300429311.0000 * 10/2006
KR 300483218.0000 * 3/2008
KR 300515150.0000 * 12/2008
WO WO-2019050126 A1 * 3/2019 A45D 40/18

* cited by examiner

(22) Filed: **Aug. 12, 2019**
(51) **LOC (13) Cl.** **09-01**
(52) **U.S. Cl.**
USPC **D9/687**; D9/686
(58) **Field of Classification Search**
USPC D9/682, 686-689, 694, 516, 529, 541,
D9/546, 559, 561, 560, 723-729,
D9/434-436, 445, 448, 452; D28/76, 77,
D28/83, 84, 85, 91.1
CPC .. B65D 83/14-759; B05B 11/00-3098; A45D
34/00; A45D 34/02; A45D 34/04; A45D
34/06; A45D 2034/002; A45D 2034/005;
A45D 2034/007; A45D 40/00; A45D
40/26; A45D 2200/054-058
See application file for complete search history.

Primary Examiner — Catherine A Tuttle

(74) *Attorney, Agent, or Firm* — Sheri Higgins; Sheri
Higgins Law, PLLC

(56) **References Cited**

U.S. PATENT DOCUMENTS

D225,327 S * 12/1972 Marsh D23/207
D304,677 S * 11/1989 Nitta D9/687
D318,610 S * 7/1991 Nitta D9/687
D584,638 S * 1/2009 Castelnovo-Tedesco D9/686
D590,720 S * 4/2009 Oates D9/560
D599,675 S * 9/2009 Premo D9/687
D655,200 S * 3/2012 Gross B65D 83/56
D9/687
D675,104 S * 1/2013 Chen D9/687
D882,409 S * 4/2020 Wong D9/686
2008/0067197 A1* 3/2008 Langlois B05B 11/00416
222/321.7
2016/0007718 A1* 1/2016 Villarreal A45D 40/28
401/117
2020/0376509 A1* 12/2020 Lee A45D 34/04

(57) **CLAIM**

The ornamental design for a dispenser, as shown and described.

DESCRIPTION

FIG. 1 is a perspective view showing my new design for a dispenser in an open position wherein the top is aligned with the underlying bottle portion;
FIG. 2 is front view of FIG. 1 thereof;
FIG. 3 is rear view thereof;
FIG. 4 is a left side view thereof, the right side view being a mirror image of the left side view.
FIG. 5 is a top view thereof;
FIG. 6 is a bottom view thereof;
FIG. 7 is a perspective view of the dispenser in a partially closed position with the top rotated approximately 45° relative to the top shown in FIG. 1; and,
FIG. 8 is a perspective view of the dispenser in a closed position with the top rotated approximately 90° relative to the top shown in FIG. 1.
The broken lines depicting the bottom of the tab in FIGS. 1, 2, 4, 6, 7 and 8 form no part of the claimed design.

1 Claim, 5 Drawing Sheets

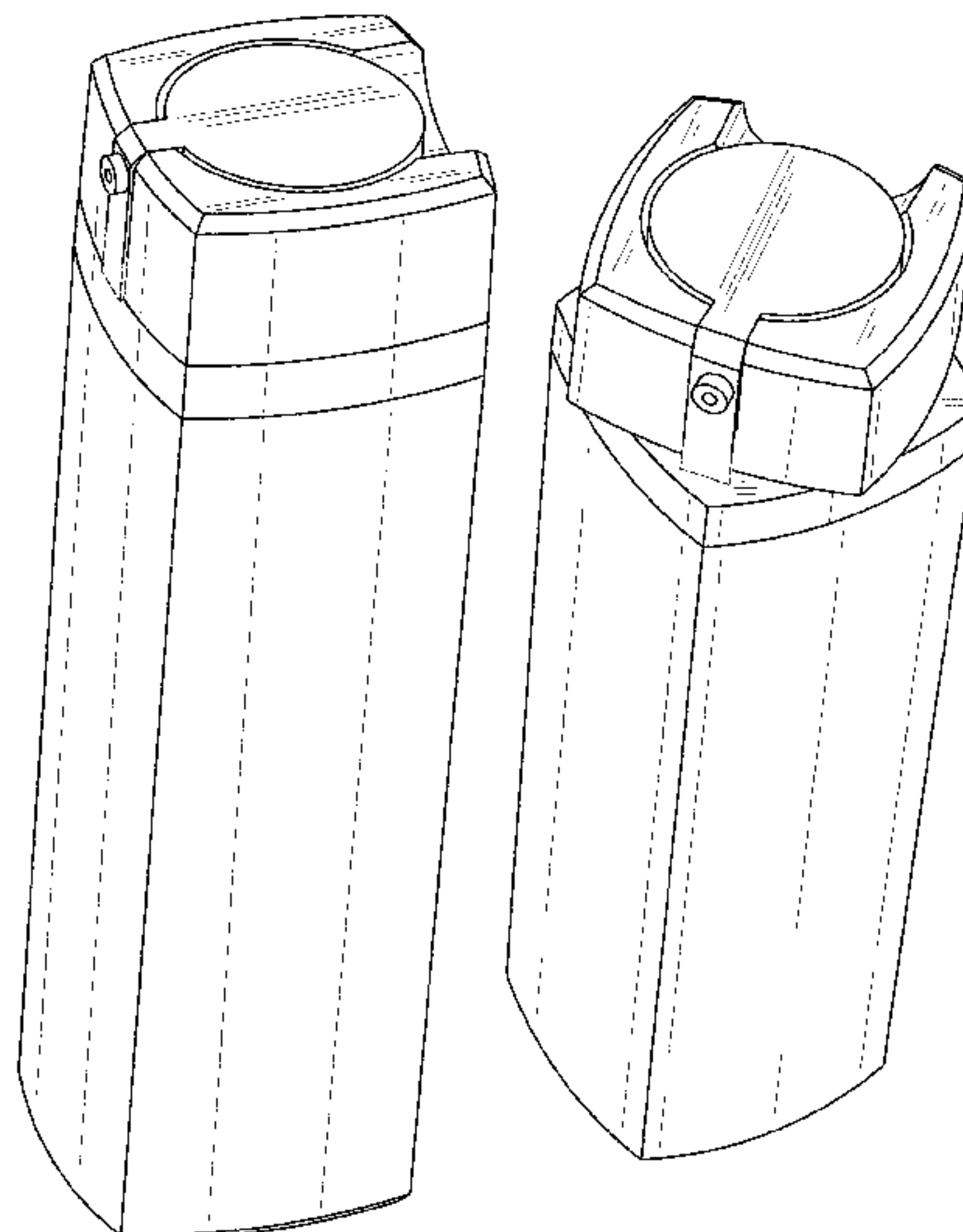

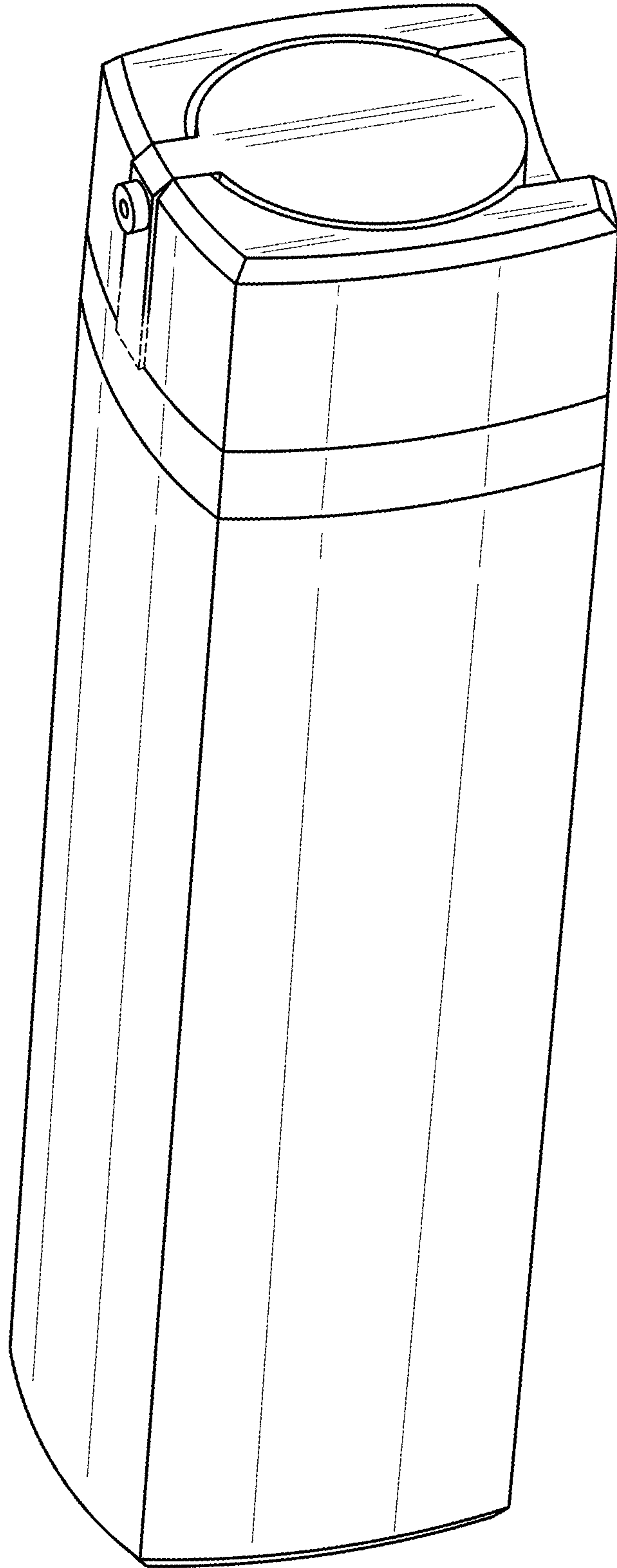

FIG. 1

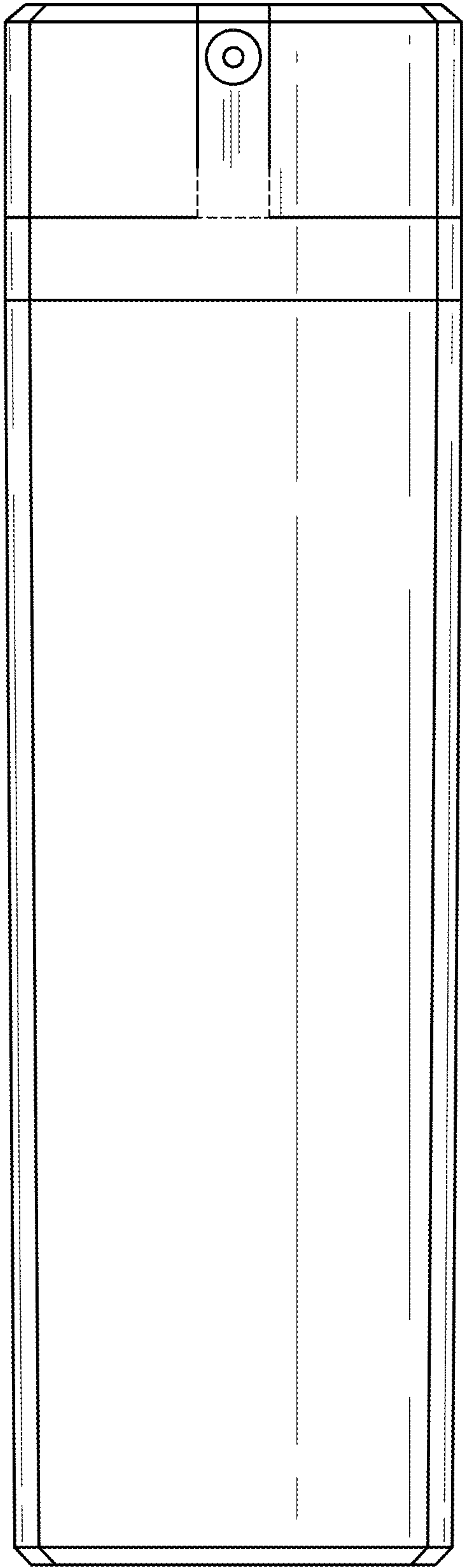

FIG. 2

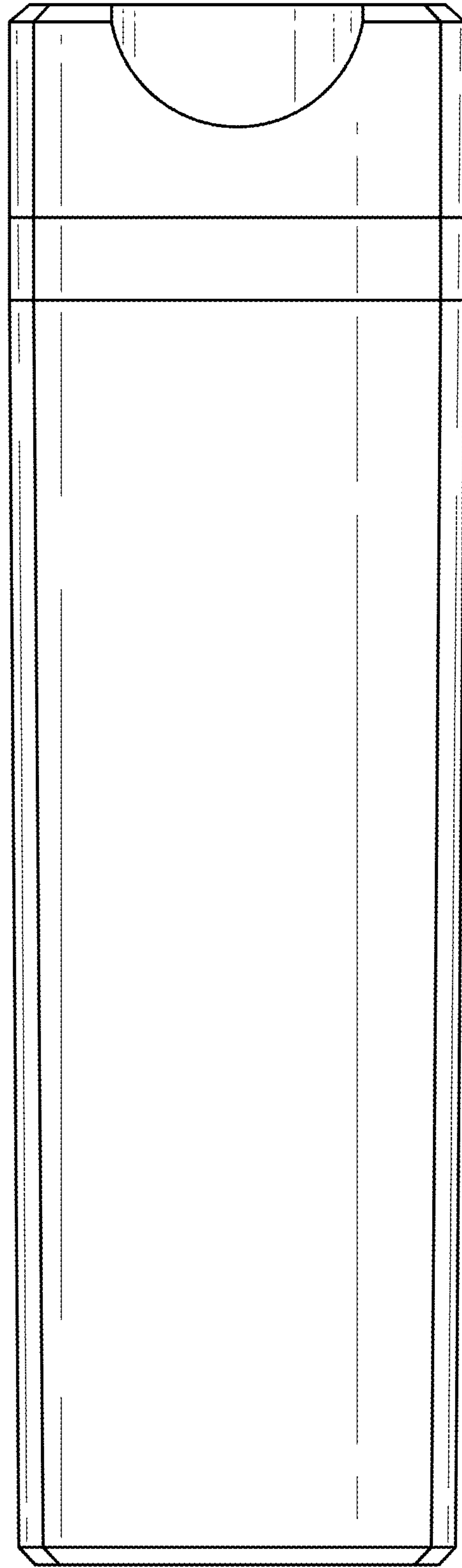

FIG. 3

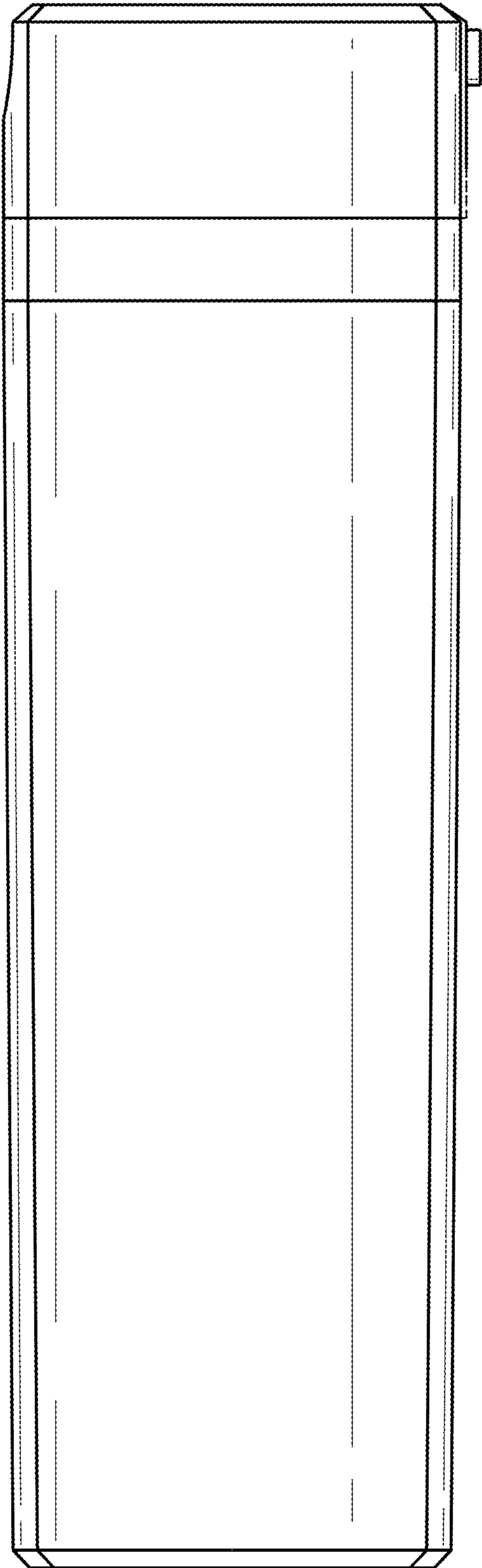

FIG.4

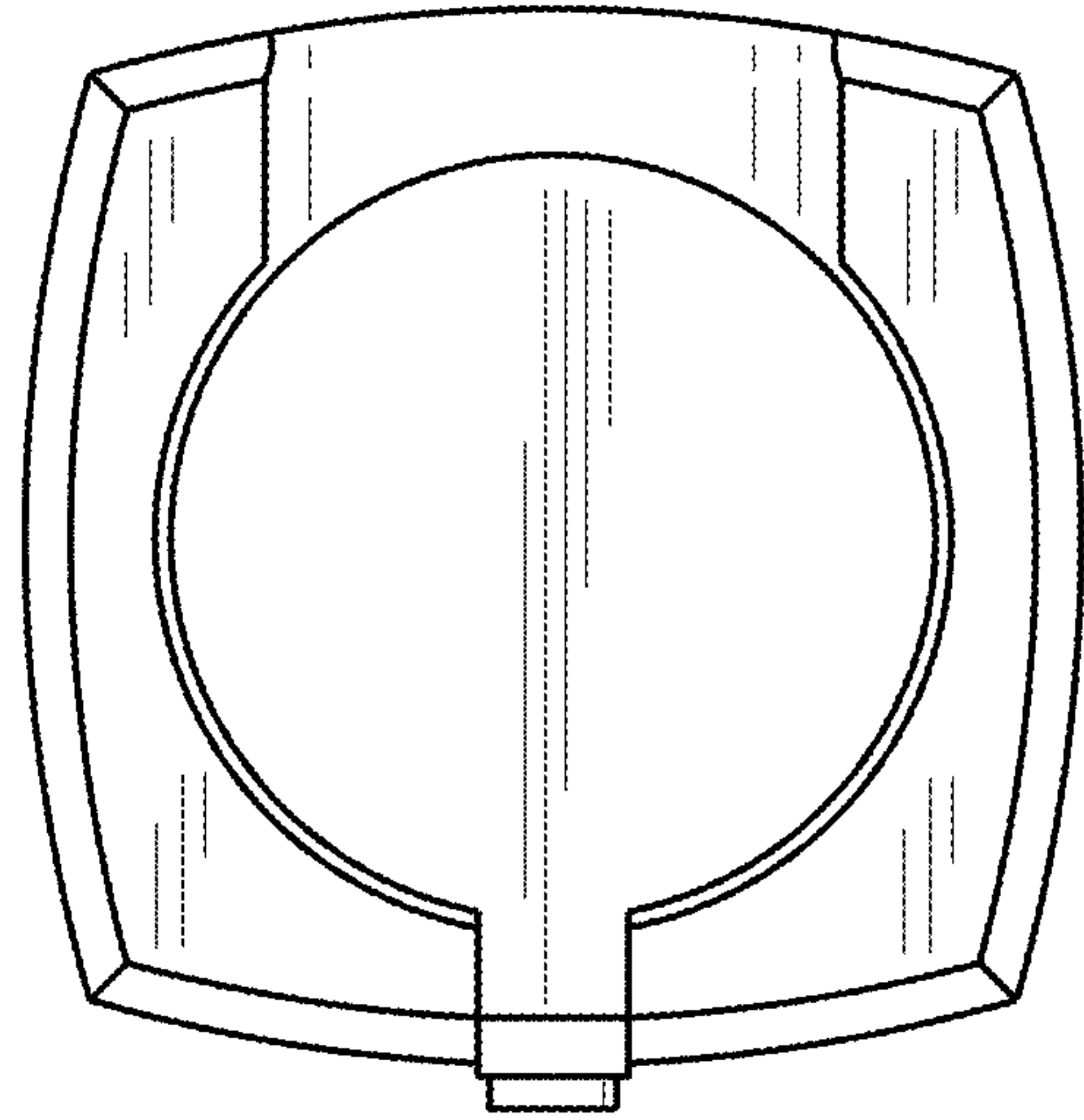

FIG.5

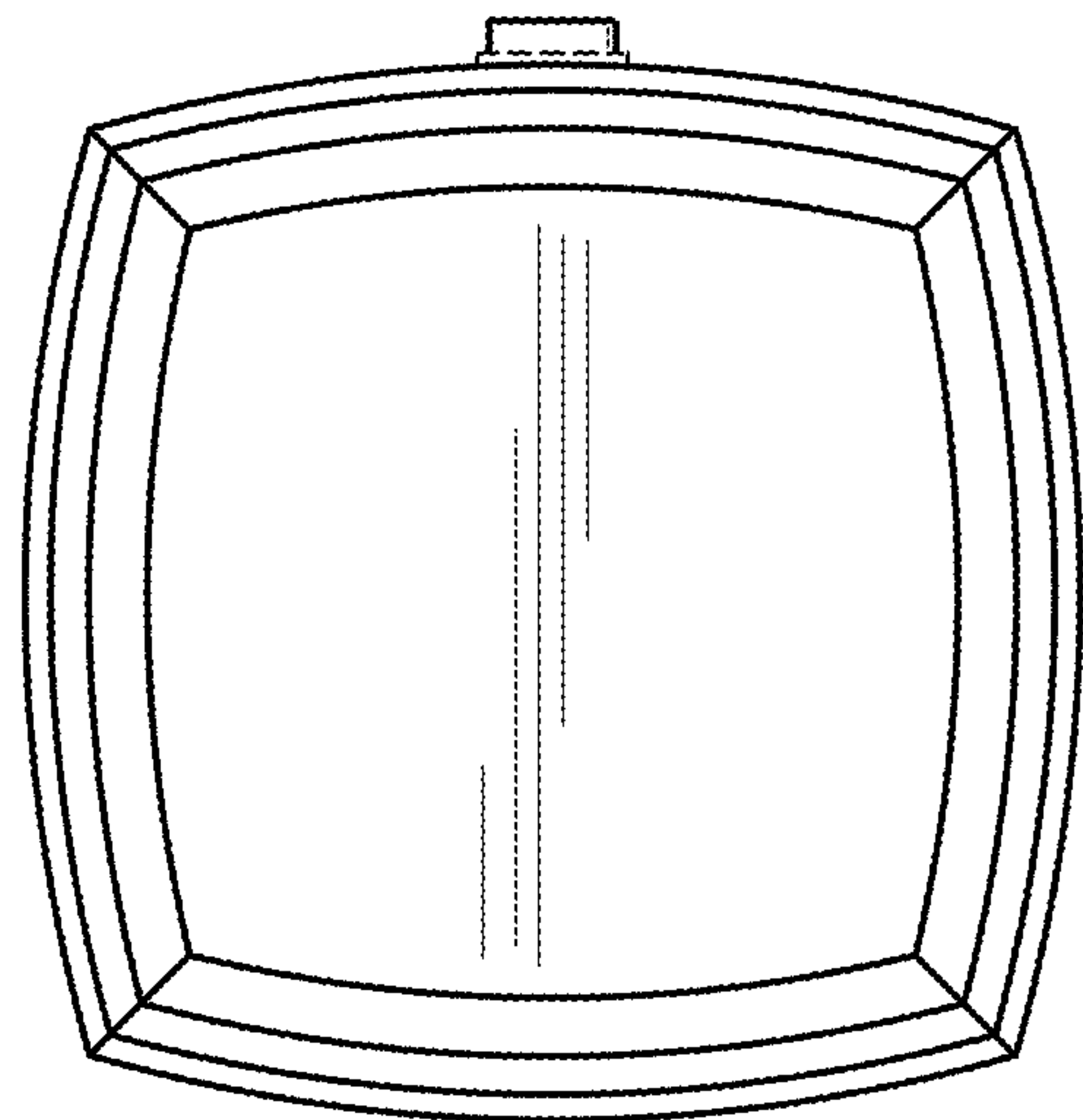

FIG.6

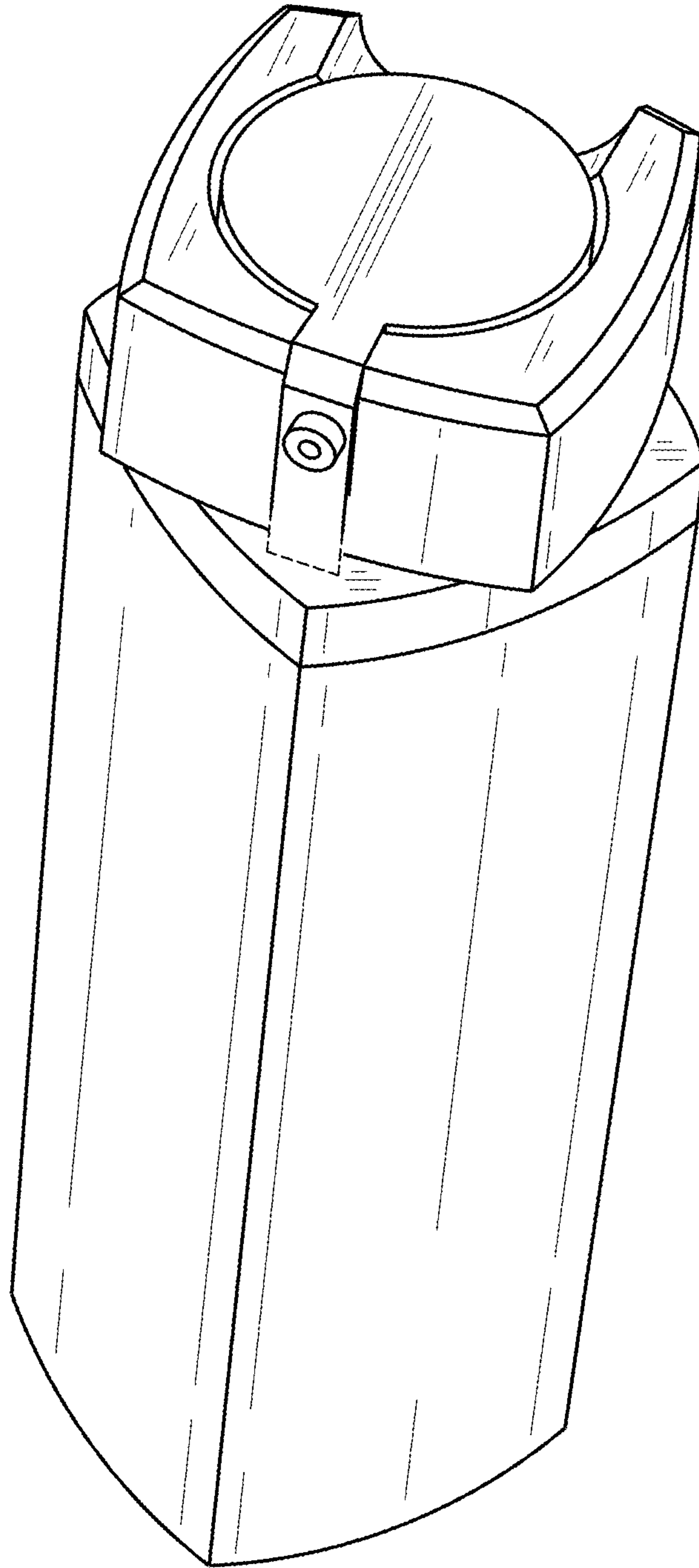

FIG. 7

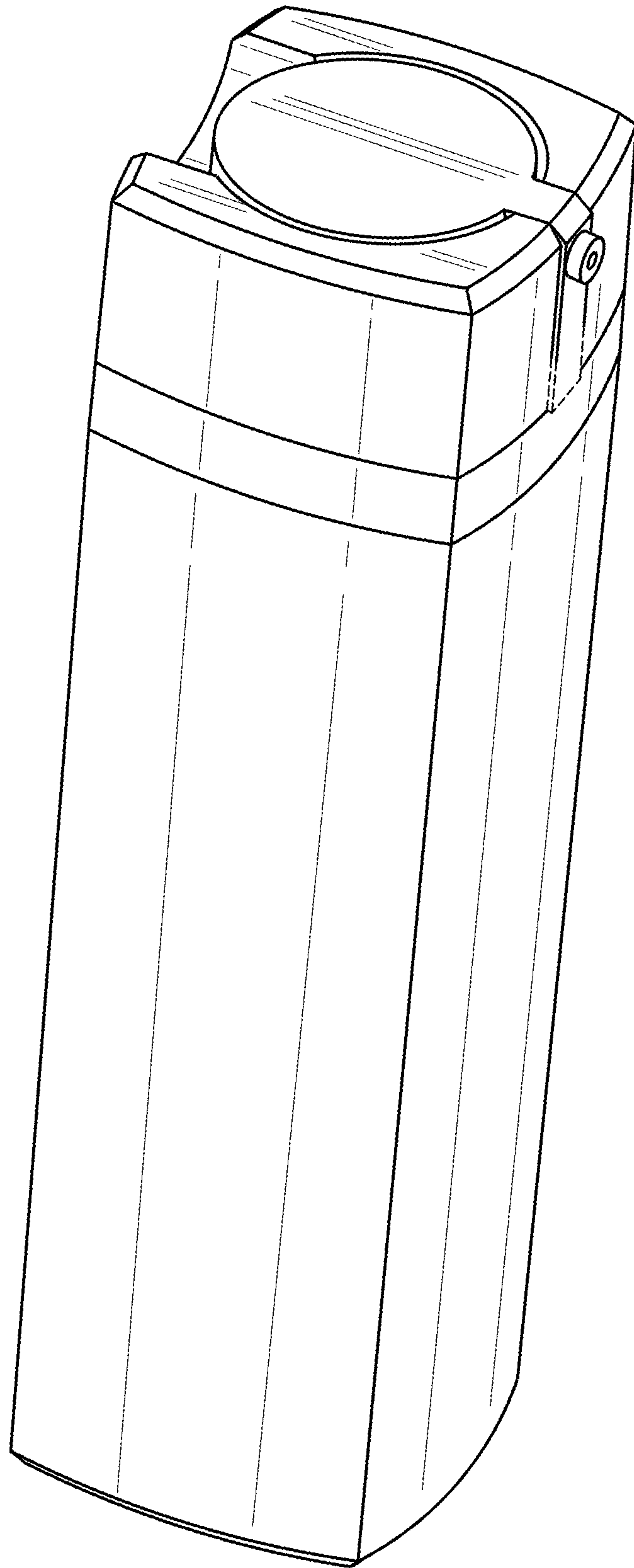

FIG.8