



US00D916588S

(12) **United States Design Patent** (10) **Patent No.:** **US D916,588 S**
Akana et al. (45) **Date of Patent:** **** Apr. 20, 2021**

(54) **PACKAGING**

(71) Applicant: **Apple Inc.**, Cupertino, CA (US)

(72) Inventors: **Jody Akana**, San Francisco, CA (US); **Bartley K. Andre**, Palo Alto, CA (US); **Shota Aoyagi**, San Francisco, CA (US); **Anthony Michael Ashcroft**, San Francisco, CA (US); **Jeremy Bataillou**, San Francisco, CA (US); **Daniel J. Coster**, San Francisco, CA (US); **Daniele De Iuliis**, San Francisco, CA (US); **M. Evans Hankey**, San Francisco, CA (US); **Julian Hoenig**, San Francisco, CA (US); **Richard P. Howarth**, San Francisco, CA (US); **Jonathan P. Ive**, San Francisco, CA (US); **Duncan Robert Kerr**, San Francisco, CA (US); **Matthew Dean Rohrbach**, San Francisco, CA (US); **Peter Russell-Clarke**, San Francisco, CA (US); **Benjamin Andrew Shaffer**, San Jose, CA (US); **Mikael Silvano**, San Francisco, CA (US); **Christopher J. Stringer**, Woodside, CA (US); **Eugene Antony Whang**, San Francisco, CA (US); **Rico Zörkendörfer**, San Francisco, CA (US)

(73) Assignee: **Apple Inc.**, Cupertino, CA (US)

(**) Term: **15 Years**

(21) Appl. No.: **29/725,295**

(22) Filed: **Feb. 24, 2020**

Related U.S. Application Data

(63) Continuation of application No. 29/665,735, filed on Oct. 5, 2018, now Pat. No. Des. 876,223, which is a (Continued)

(51) **LOC (13) Cl.** **09-03**

(52) **U.S. Cl.**
USPC **D9/432; D9/424**

(58) **Field of Classification Search**

USPC D9/414-433, 434, 456, 457, 711, 713, D9/721-722, 737, 756, 758, 759, 760; D3/272-274; D20/10, 22, 27, 40, 42
(Continued)

(56) **References Cited**

U.S. PATENT DOCUMENTS

1,735,061 A 11/1929 Sheilds
D303,765 S 10/1989 Kaplan
(Continued)

FOREIGN PATENT DOCUMENTS

WO DM/031323 1/1995

OTHER PUBLICATIONS

Jewelry's Circular—Keystone, Jul. 31, 1990. Japanese Patent Office Document HB02021354.

(Continued)

Primary Examiner — Vy N Koenig

(74) *Attorney, Agent, or Firm* — Sterne, Kessler, Goldstein & Fox P.L.L.C.

(57) **CLAIM**

The ornamental design for packaging, as shown and described.

DESCRIPTION

FIG. 1 is a top front perspective view of packaging showing the claimed design;

FIG. 2 is a front view thereof;

FIG. 3 is a rear view thereof;

FIG. 4 is a left side view thereof;

FIG. 5 is a right side view thereof

FIG. 6 is a top view thereof;

FIG. 7 is a bottom view thereof;

FIG. 8 is an exploded top front perspective view thereof, separating the upper portion of the packaging from the lower portion of the packaging;

(Continued)

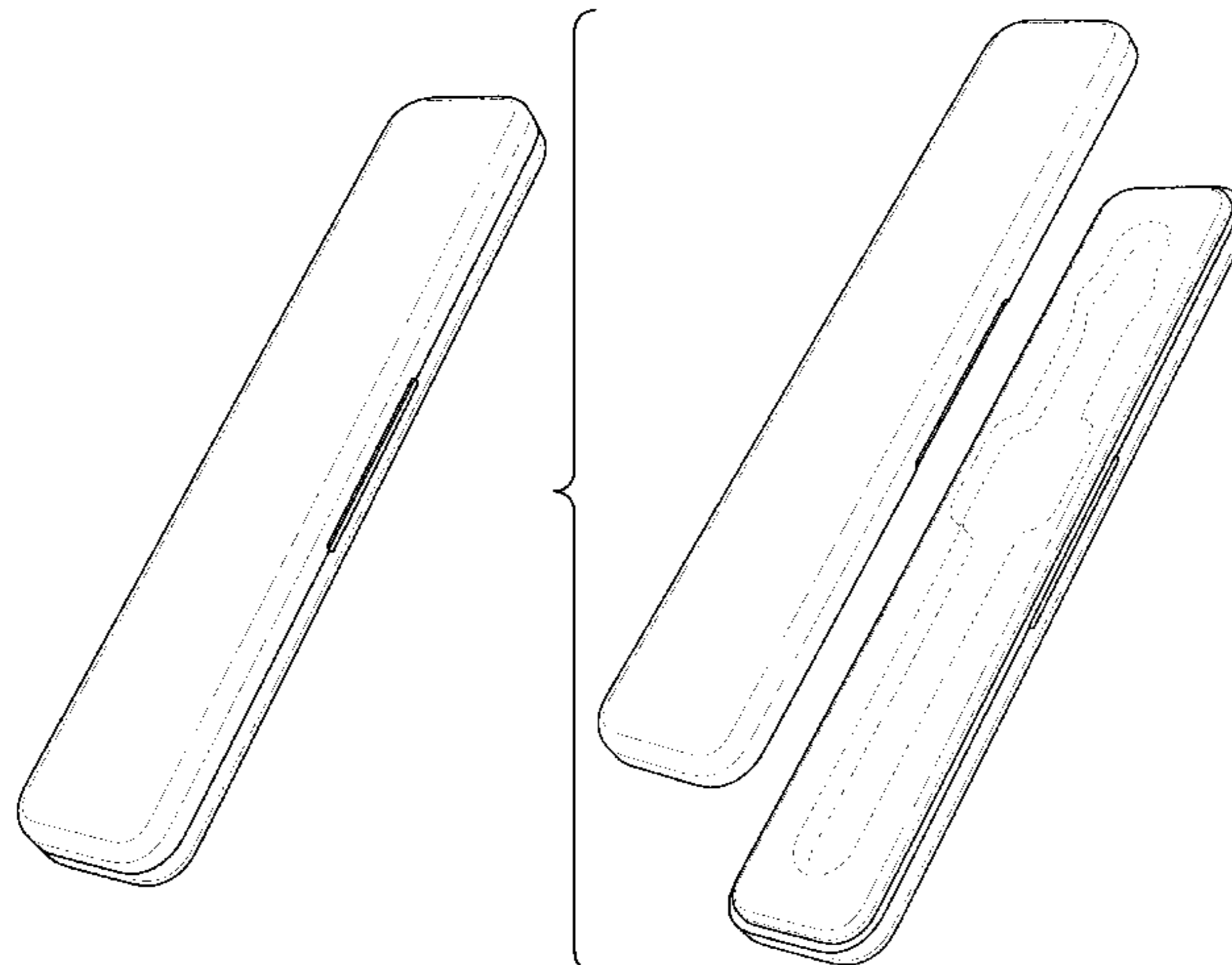

FIG. 9 is a front view of the lower portion of the packaging of FIG. 8;
 FIG. 10 is a rear view thereof;
 FIG. 11 is a left side view thereof;
 FIG. 12 is a right side view thereof;
 FIG. 13 is a top view thereof
 FIG. 14 is a bottom view thereof;
 FIG. 15 is a top view thereof showing the packaging in an environment in which it may be used;
 FIG. 16 is a front view of the upper portion of the packaging of FIG. 8;
 FIG. 17 is a rear view thereof;
 FIG. 18 is a left side view thereof;
 FIG. 19 is a right side view thereof;
 FIG. 20 is a top view thereof; and,
 FIG. 21 is a bottom view thereof.
 The broken lines in the Figures show portions of the packaging or environment that form no part of the claimed design.

1 Claim, 12 Drawing Sheets

Related U.S. Application Data

continuation of application No. 29/606,609, filed on Jun. 6, 2017, now Pat. No. Des. 830,169, which is a continuation of application No. 29/565,702, filed on May 24, 2016, now Pat. No. Des. 790,964, which is a continuation of application No. 29/500,912, filed on Aug. 29, 2014, now Pat. No. Des. 764,285.

(58) **Field of Classification Search**

CPC ... B65D 5/00; B65D 5/02; B65D 5/18; B65D 5/20

See application file for complete search history.

(56) **References Cited**

U.S. PATENT DOCUMENTS

5,186,320 A * 2/1993 Aida A45C 11/34
 206/214
 D340,409 S 10/1993 Hirsch
 D365,754 S 1/1996 Plassier
 D369,103 S * 4/1996 Plassier D9/418
 D369,295 S 4/1996 Kobari et al.

D369,973 S 5/1996 Dikowitz
 D389,639 S 1/1998 Priebe
 D406,756 S 3/1999 Garganese
 D417,391 S 12/1999 Szczepanski et al.
 D427,432 S * 7/2000 Au D3/263
 D464,260 S * 10/2002 Dijkstra D9/418
 D502,868 S * 3/2005 Cattaruzza D3/294
 D506,744 S 6/2005 Andre et al.
 D509,132 S * 9/2005 Au D3/294
 D558,572 S 1/2008 Andre et al.
 D577,197 S * 9/2008 Guerriero D3/294
 D580,752 S 11/2008 Andre et al.
 D582,267 S 12/2008 Andre et al.
 D584,142 S 1/2009 Andre et al.
 D601,884 S 10/2009 Andre et al.
 D616,738 S 6/2010 Andre et al.
 D616,741 S 6/2010 Andre et al.
 D621,256 S 8/2010 Andre et al.
 D648,630 S * 11/2011 Doster D9/456
 D658,492 S 5/2012 Akana et al.
 D659,530 S 5/2012 Akana et al.
 D660,723 S 5/2012 Akana et al.
 D668,143 S 10/2012 Akana et al.
 D677,563 S 3/2013 Andre et al.
 D685,654 S 7/2013 Akana et al.
 D695,632 S 12/2013 Akana et al.
 D702,547 S 3/2014 Akana et al.
 D706,643 S 6/2014 Akana et al.
 D712,279 S 9/2014 Akana et al.
 D712,748 S 9/2014 Akana et al.
 D713,738 S 9/2014 Akana et al.
 D713,739 S 9/2014 Akana et al.
 D713,740 S 9/2014 Akana et al.
 D764,285 S 8/2016 Akana et al.
 D764,910 S 8/2016 Akana et al.
 D778,161 S 2/2017 Anderson et al.
 D789,800 S 6/2017 Cernokus et al.
 D790,964 S * 7/2017 Akana D9/432
 D793,856 S * 8/2017 Akana D9/425
 D800,549 S * 10/2017 Delle Cese D9/419
 D830,169 S * 10/2018 Akana D9/434
 D832,103 S * 10/2018 Anderson D9/456
 D856,147 S * 8/2019 Anderson D9/456
 D859,979 S * 9/2019 Akana D9/432
 D872,578 S * 1/2020 Anderson D9/456
 D893,314 S * 8/2020 Anderson D9/721

OTHER PUBLICATIONS

Make It Difference AIHAO 2006 Catalog, 54, AHP—C08. Japanese Patent Office Document HD18006207.

* cited by examiner

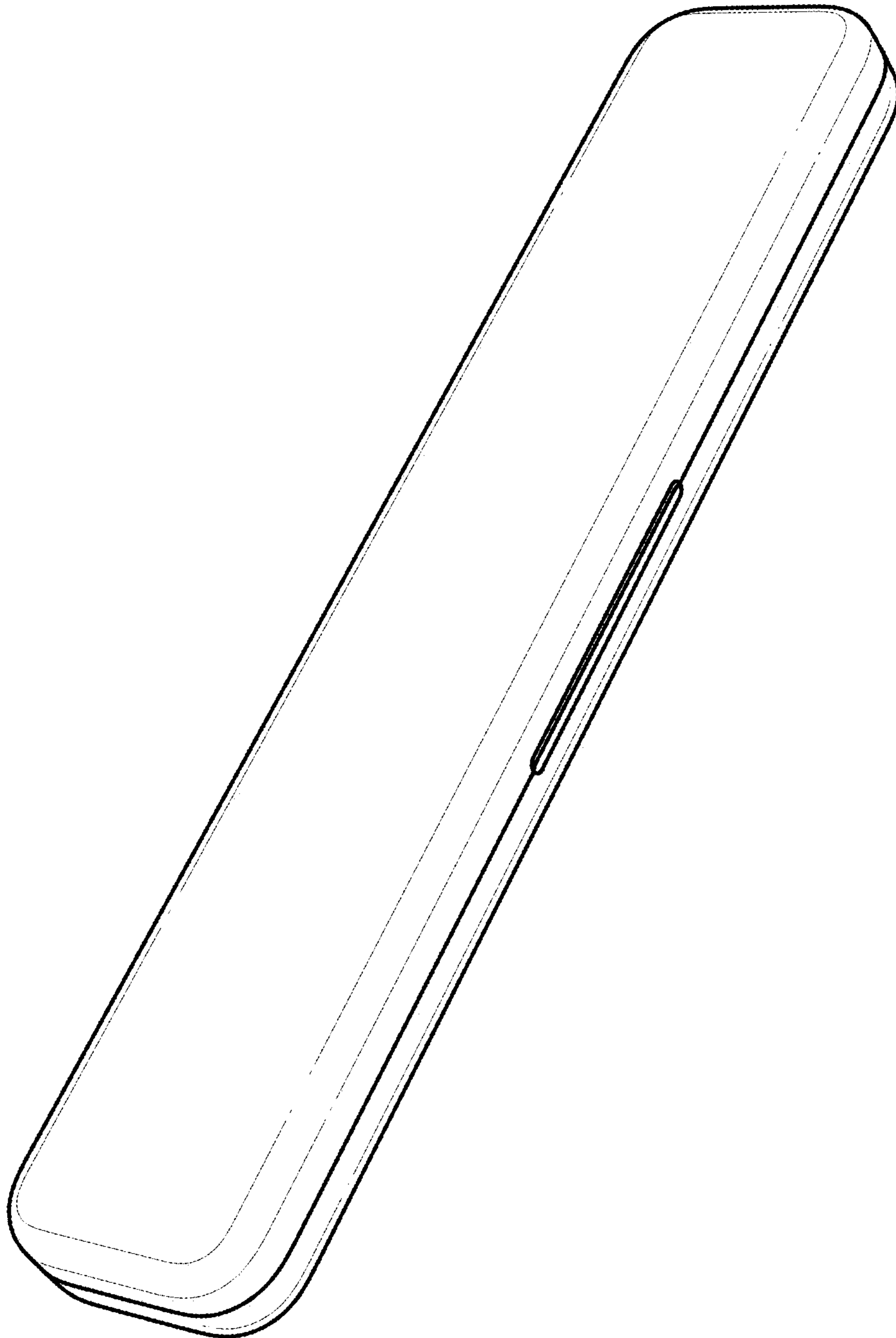

FIG. 1

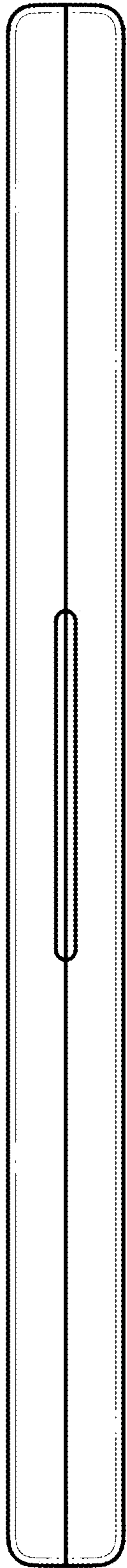

FIG. 2

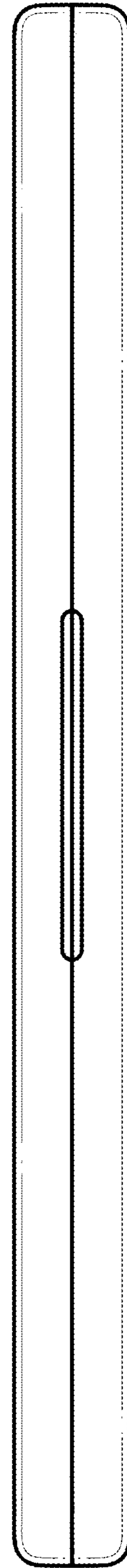

FIG. 3

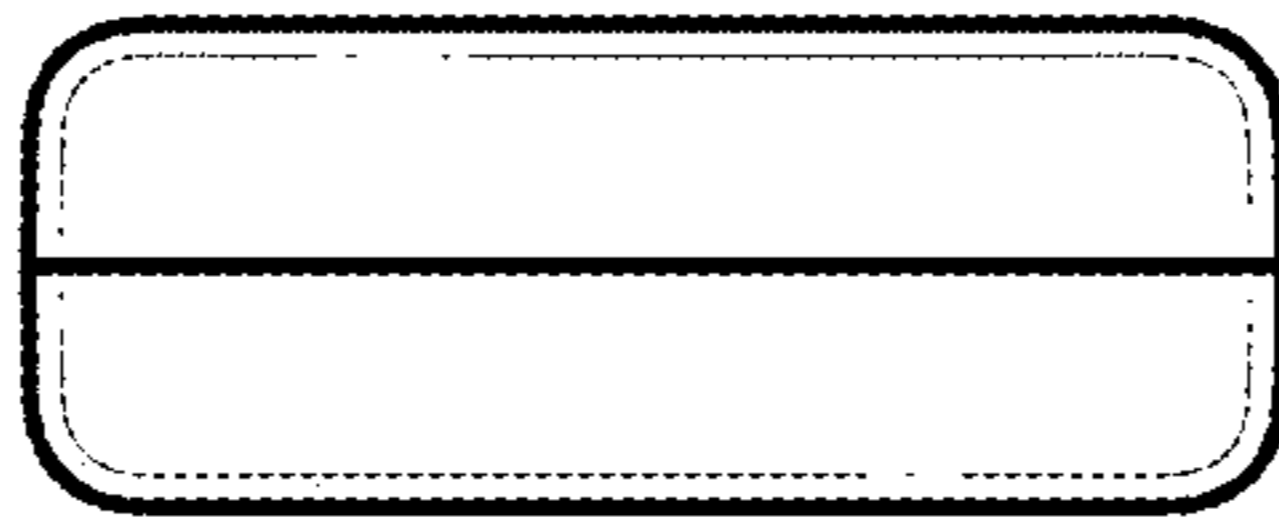

FIG. 4



FIG. 5

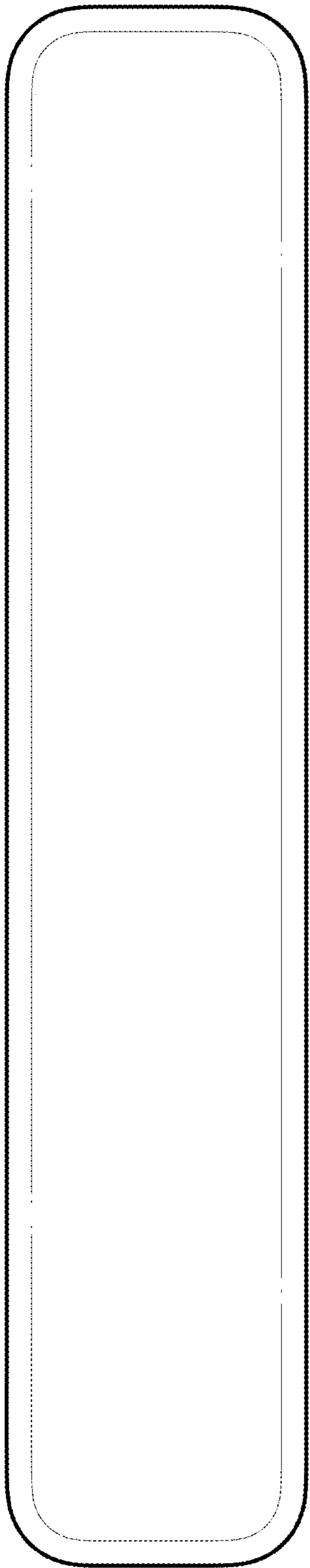

FIG. 6

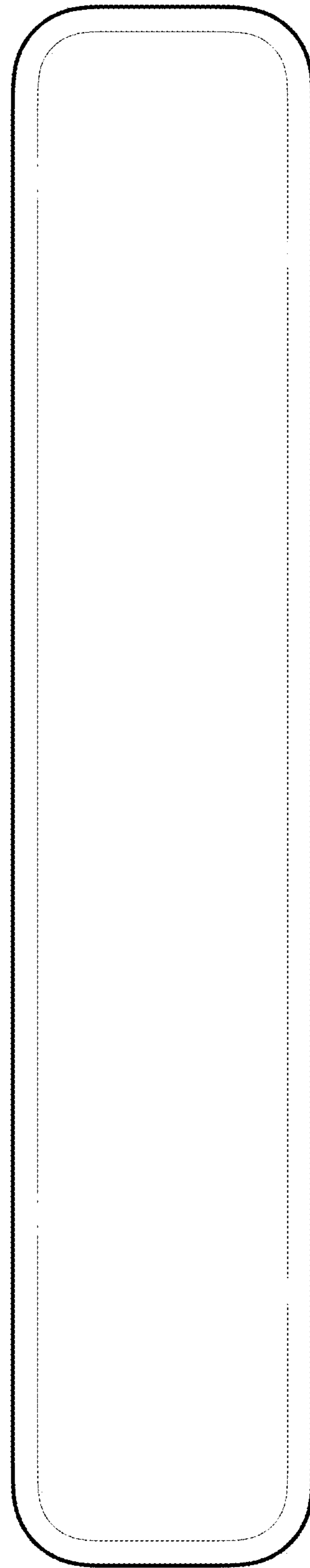

FIG. 7

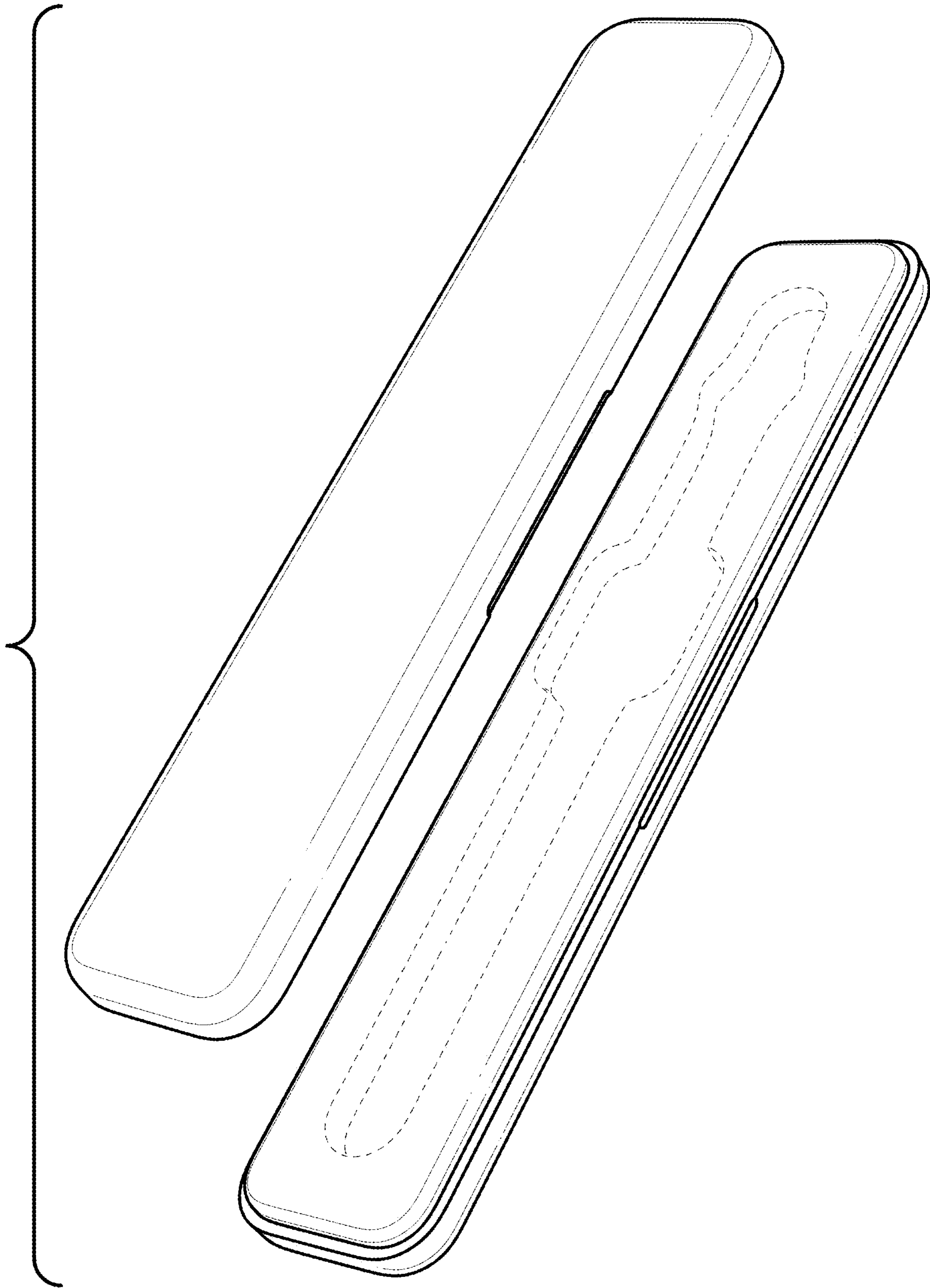

FIG. 8

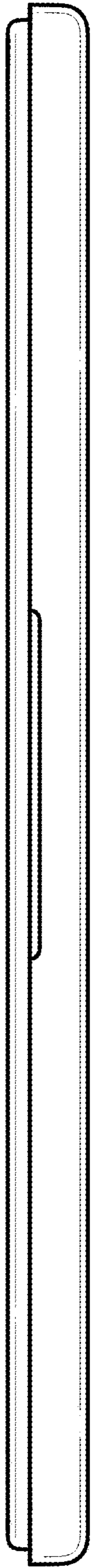

FIG. 9

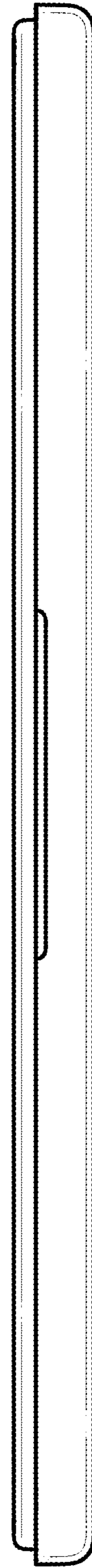

FIG. 10

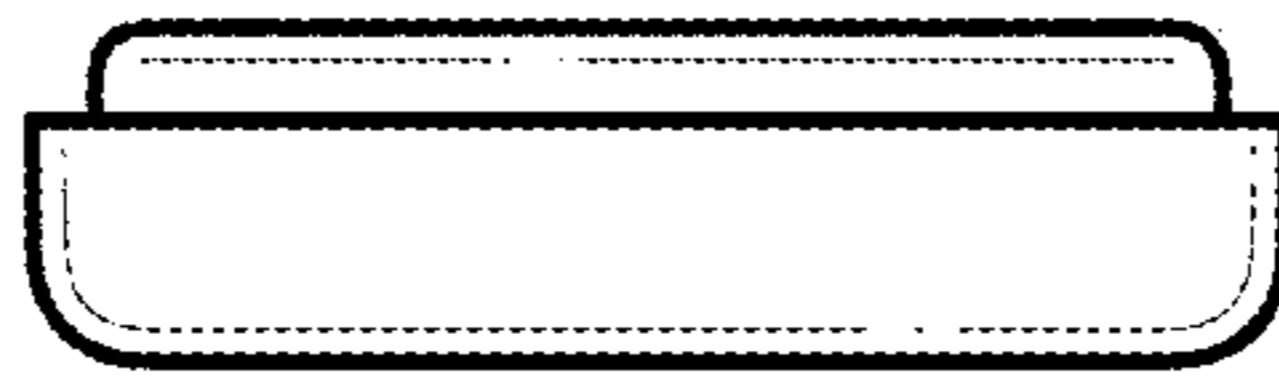

FIG. 11



FIG. 12

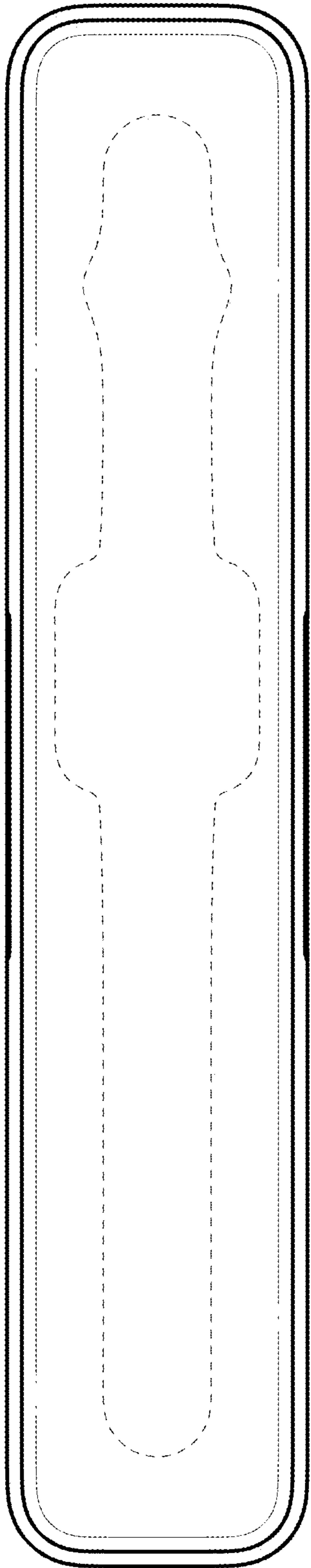

FIG. 13

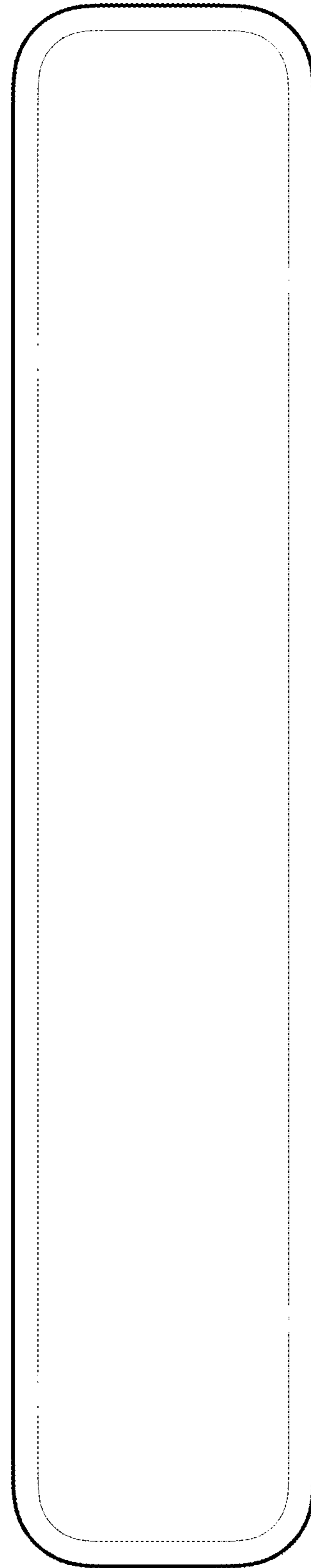

FIG. 14

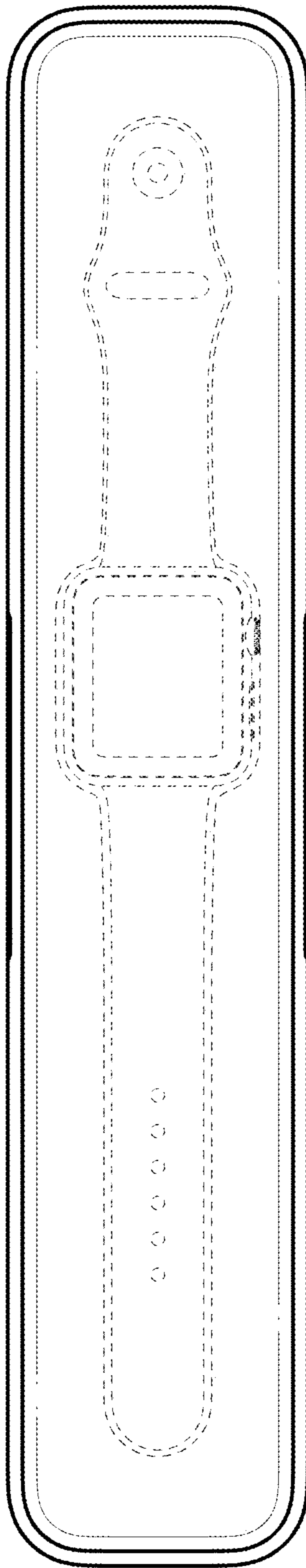

FIG. 15

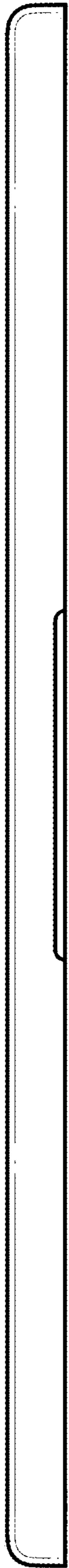

FIG. 16

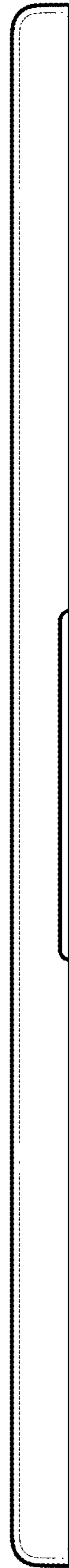

FIG. 17



FIG. 18



FIG. 19

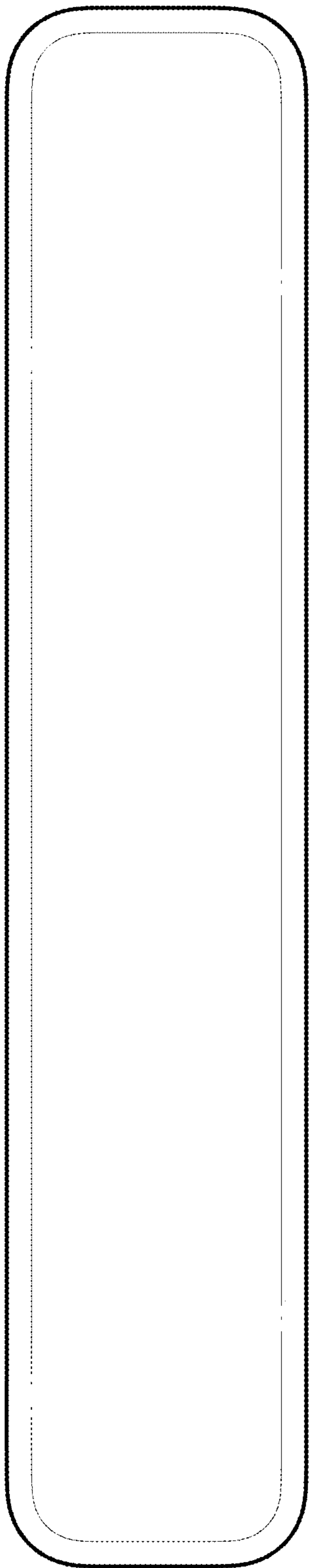

FIG. 20

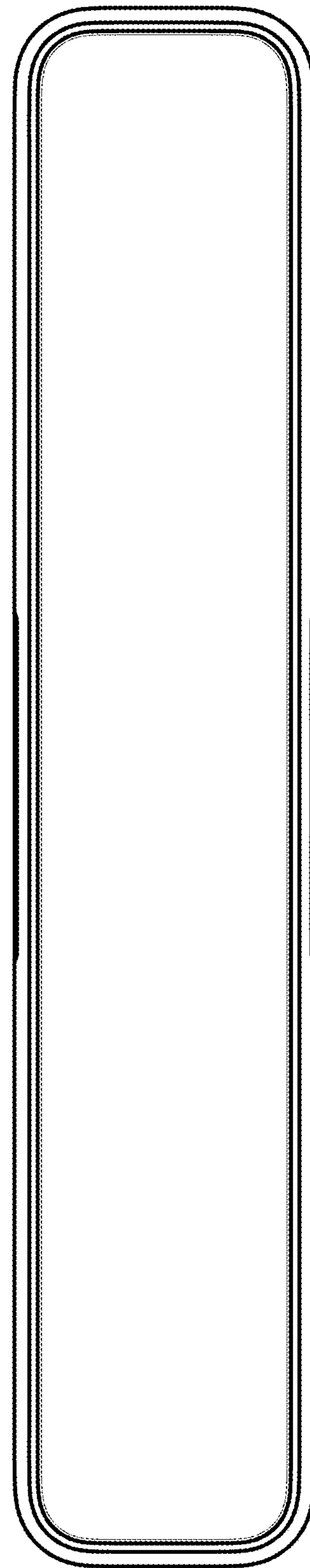

FIG. 21