



US00D916518S

(12) **United States Design Patent**
Eads

(10) **Patent No.:** **US D916,518 S**

(45) **Date of Patent:** **** Apr. 20, 2021**

(54) **SHELF**

(71) Applicant: **DELTA FAUCET COMPANY,**
Indianapolis, IN (US)

(72) Inventor: **Thad Eads,** Urbana, IN (US)

(73) Assignee: **DELTA FAUCET COMPANY,**
Indianapolis, IN (US)

(**) Term: **15 Years**

(21) Appl. No.: **29/683,461**

(22) Filed: **Mar. 13, 2019**

(51) **LOC (13) Cl.** **06-04**

(52) **U.S. Cl.**
USPC **D6/574**

(58) **Field of Classification Search**

USPC D6/574, 320-324, 524, 567, 642;
D7/698; D2/672; D26/72; 108/28-29,
108/152; 211/13.1, 42, 86.01, 88.01,
211/90.01, 90.03, 126.1, 134, 153;
248/205.3, 235, 243, 247, 250; D23/305
CPC A47B 43/00; A47B 43/04; A47B 47/0066;
A47B 47/04; A47B 63/00; A47B 69/00;
A47B 71/00

See application file for complete search history.

(56) **References Cited**

U.S. PATENT DOCUMENTS

D545,604 S * 7/2007 Eyman D6/574
D764,834 S * 8/2016 Citterio D6/574

D846,304 S * 4/2019 Allen D6/574
D866,220 S * 11/2019 Lee D6/574
D878,804 S * 3/2020 Khardori D6/574
D880,199 S * 4/2020 Xia D6/642
D889,928 S * 7/2020 Eads D8/316

* cited by examiner

Primary Examiner — Mark Booker

(74) *Attorney, Agent, or Firm* — Nirav D. Parikh; Edgar
A. Zarins

(57) **CLAIM**

The ornamental design for a shelf, as shown and described.

DESCRIPTION

FIG. 1 is a front perspective view of a shelf showing my new design;
FIG. 2 is a rear perspective view thereof;
FIG. 3 is a front elevational view thereof;
FIG. 4 is a left side view thereof;
FIG. 5 is a rear view thereof;
FIG. 6 is a right side view thereof; and,
FIG. 7 is a top plan view thereof.
The broken lines shown in the figures represent portions of the shelf that form no part of the claimed design.

1 Claim, 4 Drawing Sheets

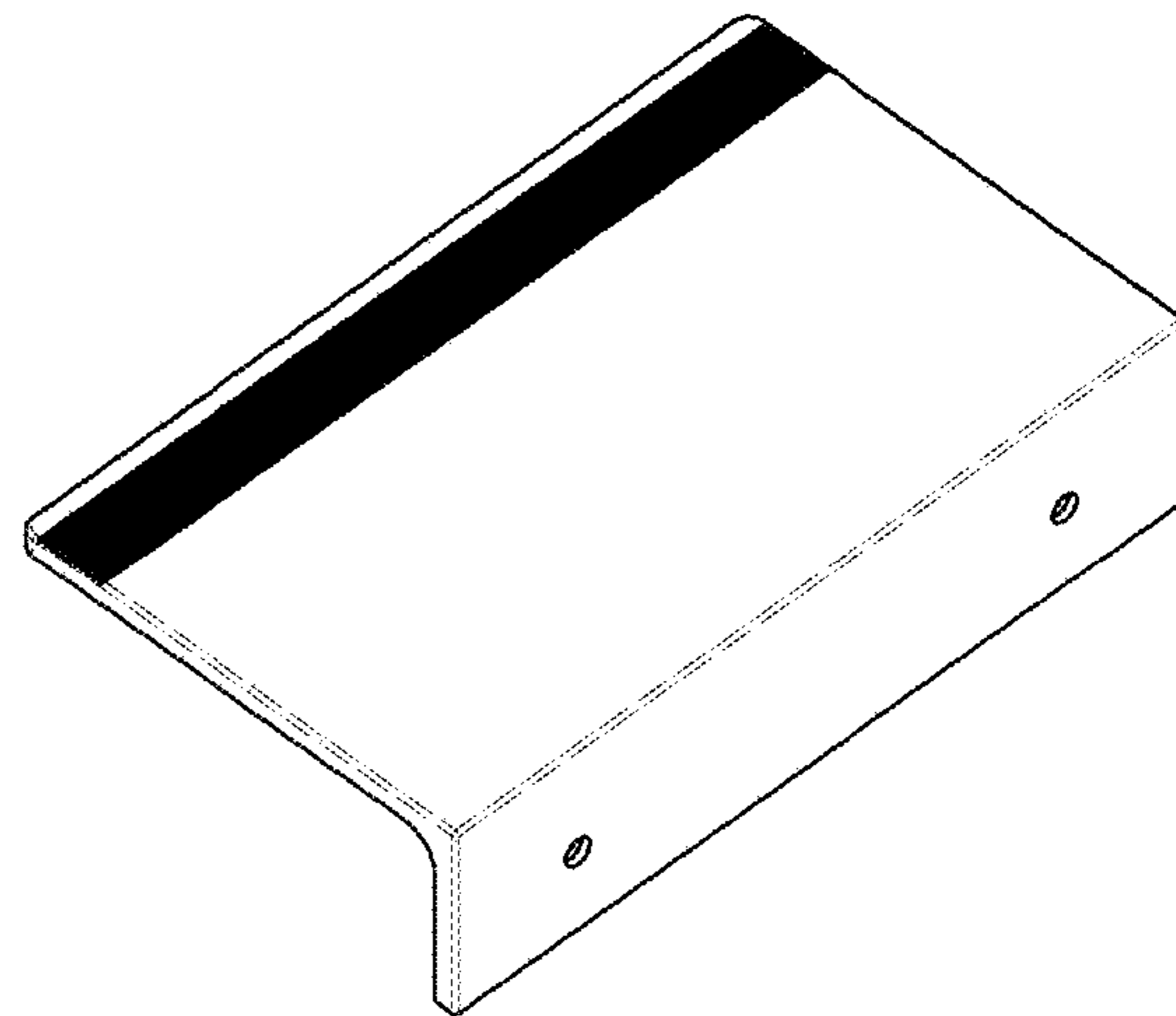
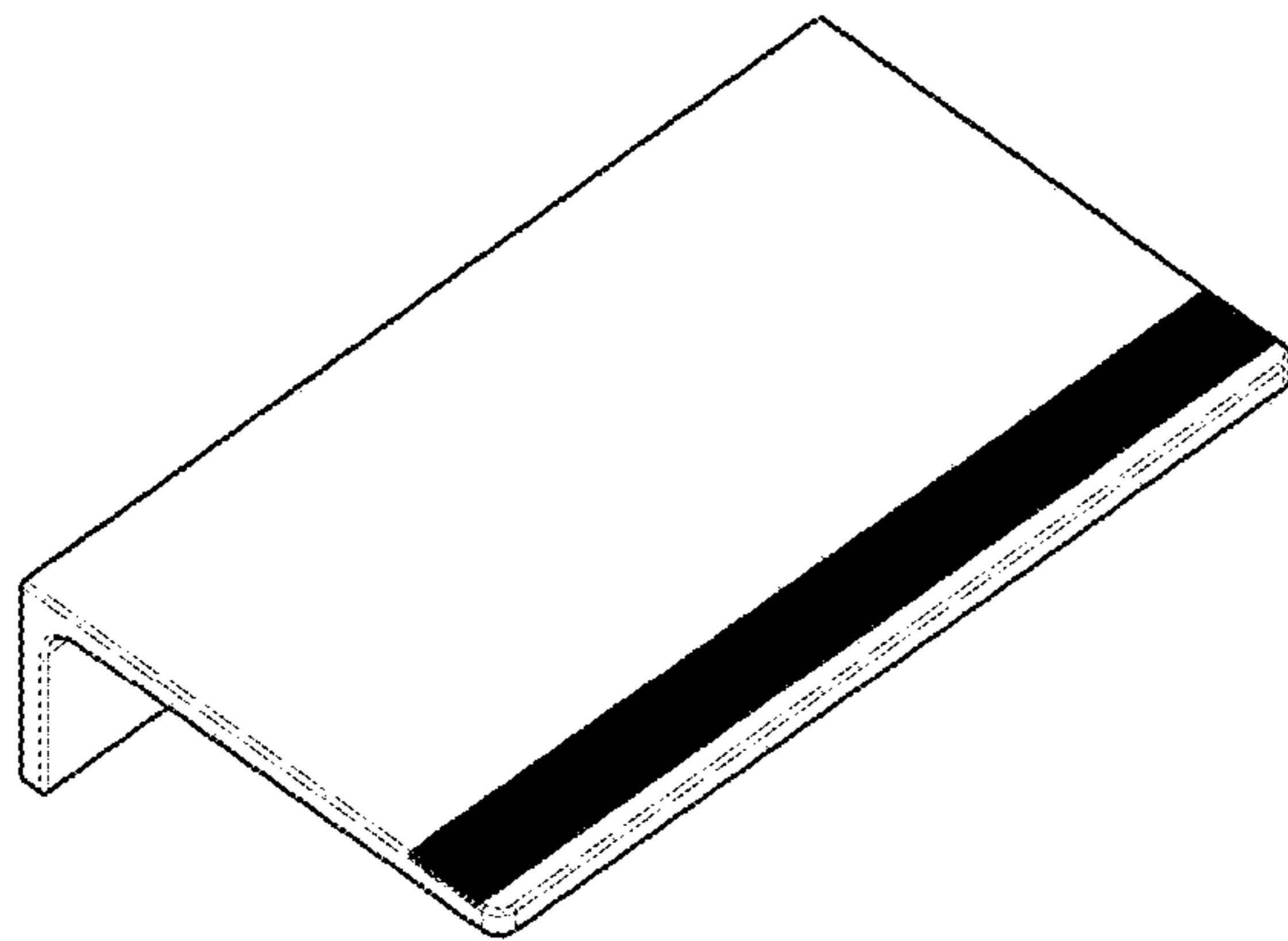

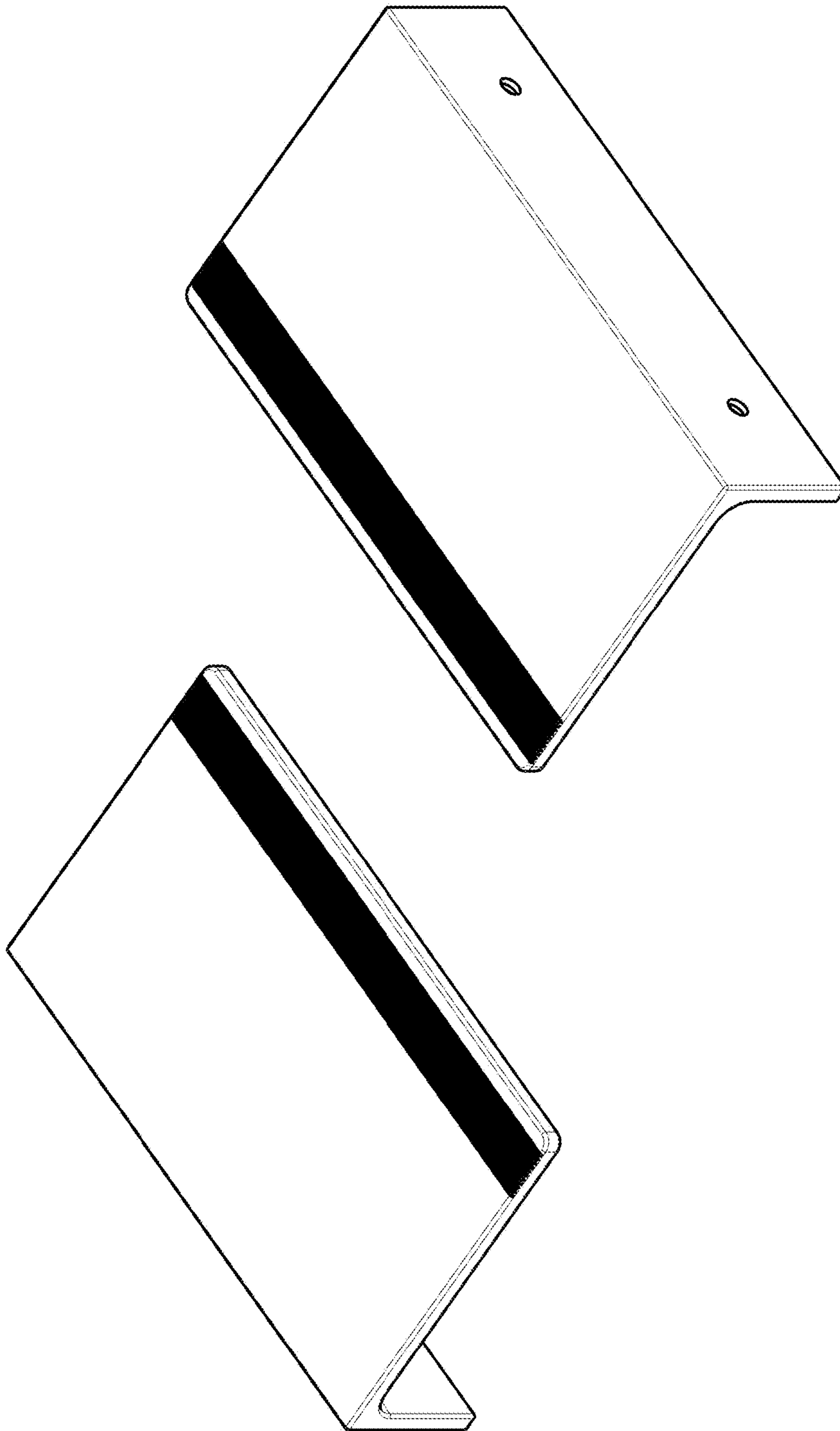

FIG - 2

FIG - 1

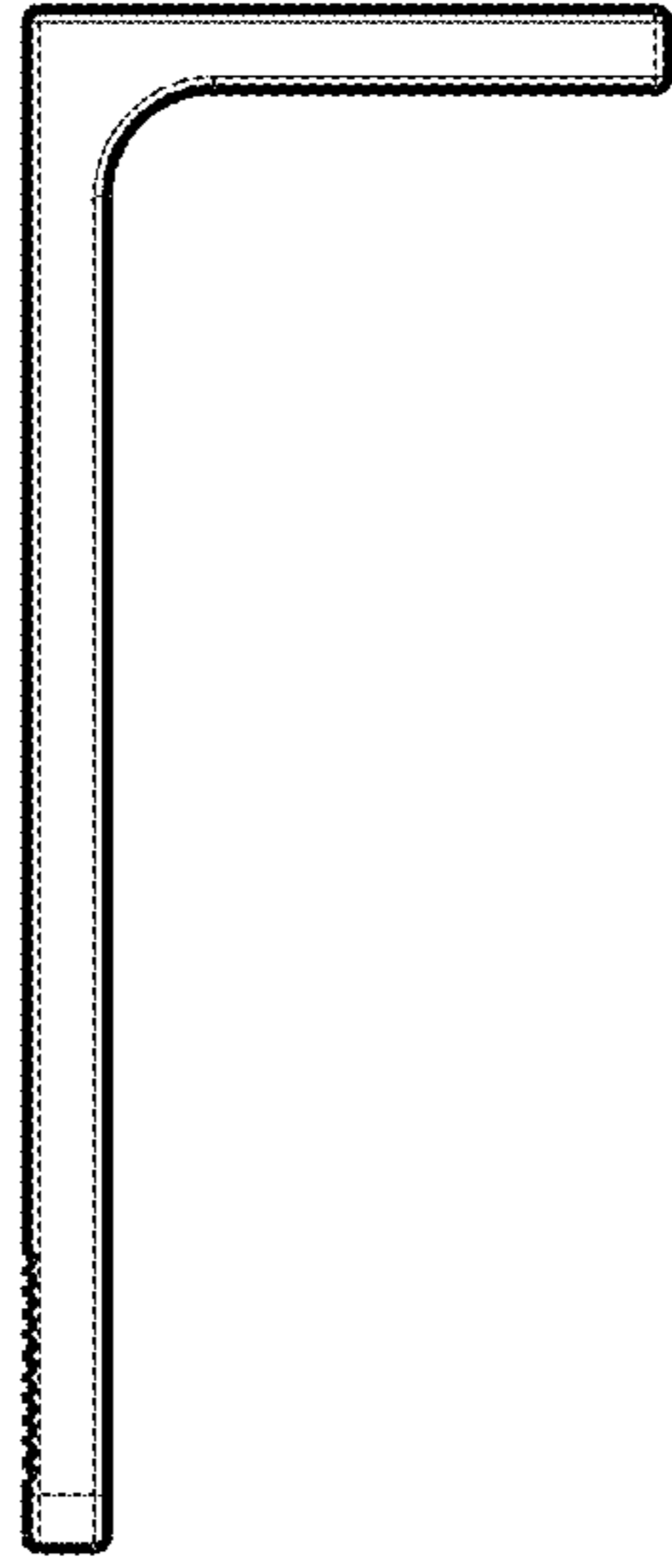

FIG - 4

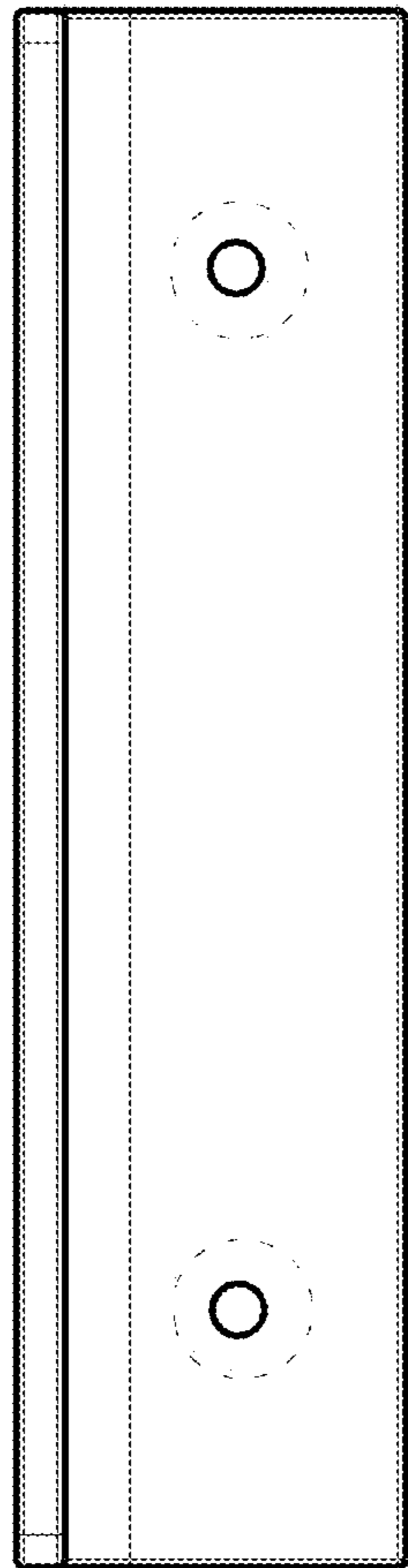

FIG - 3

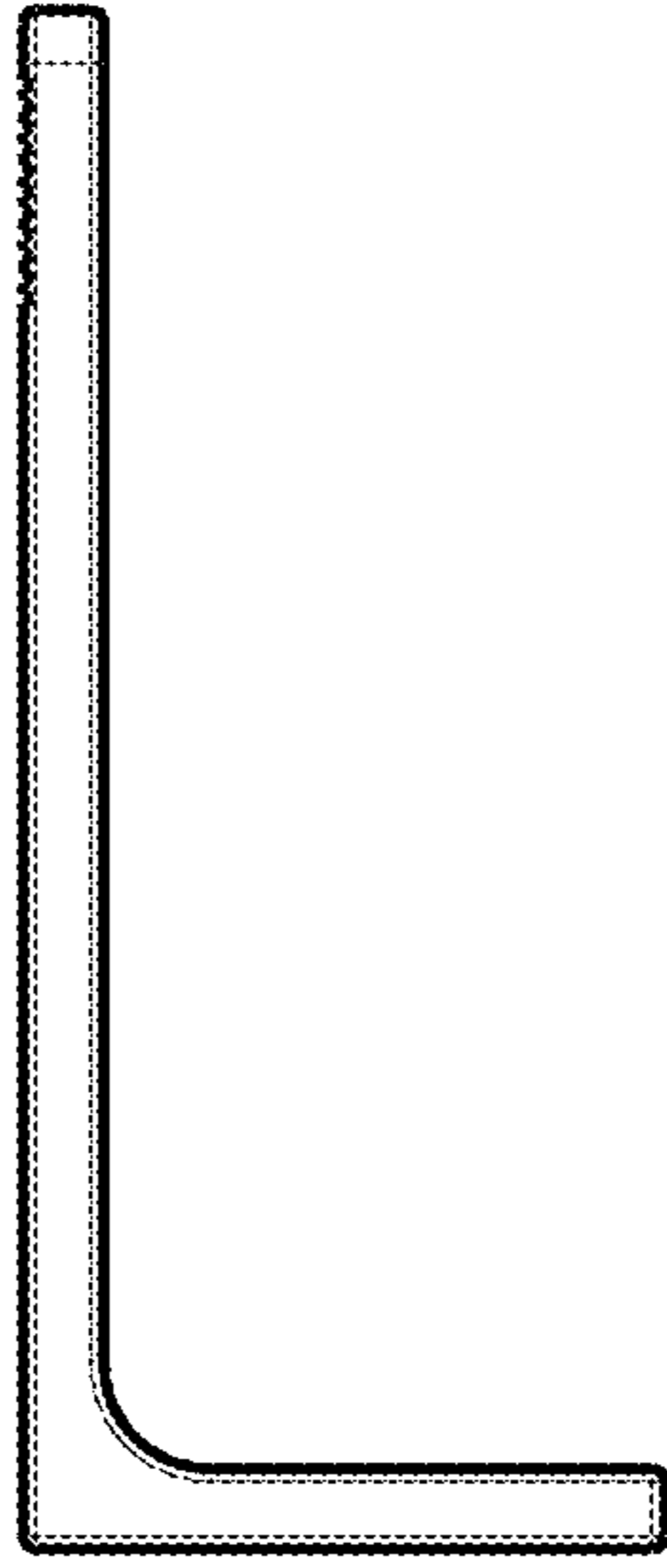

FIG - 6

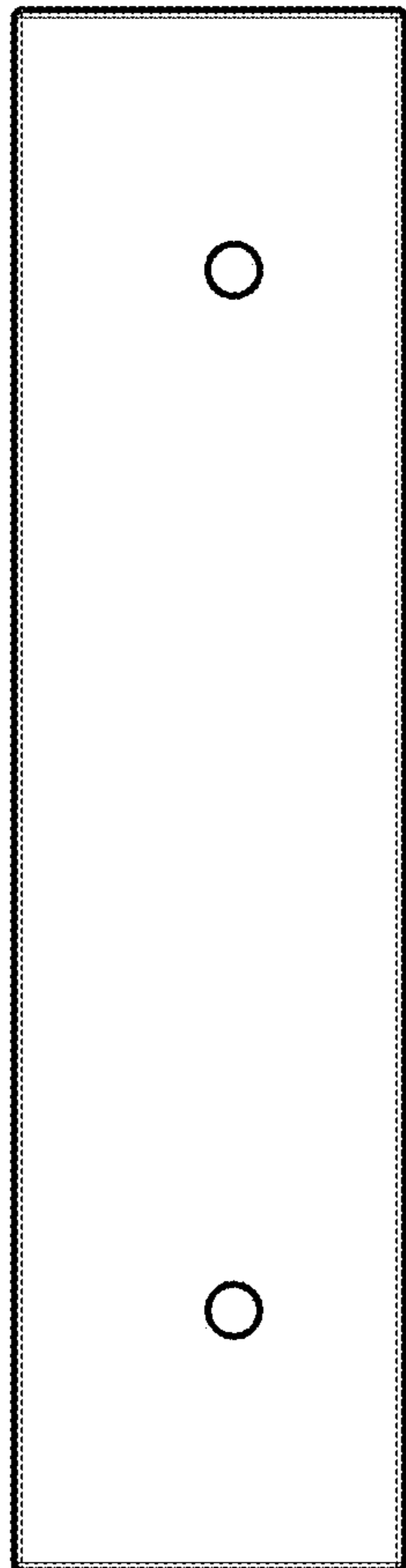

FIG - 5

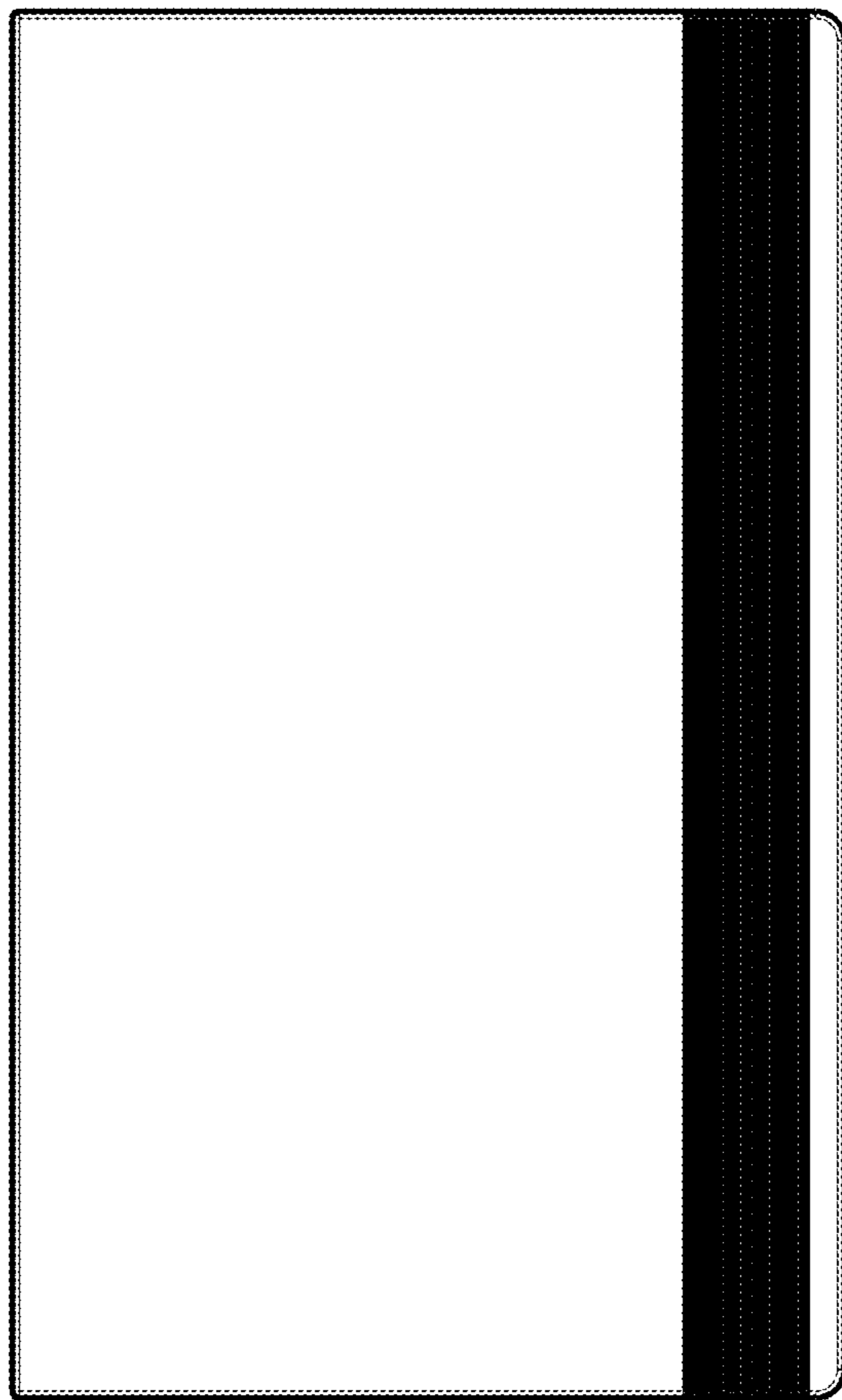

FIG - 7