



US00D916511S

(12) **United States Design Patent**  
**Padgett**

(10) **Patent No.:** **US D916,511 S**

(45) **Date of Patent:** **\*\* Apr. 20, 2021**

(54) **PLANT SUPPORT DEVICE**

(71) Applicant: **Leslie Padgett**, Waynesboro, GA (US)

(72) Inventor: **Leslie Padgett**, Waynesboro, GA (US)

(\*\*) Term: **15 Years**

(21) Appl. No.: **29/752,055**

(22) Filed: **Sep. 24, 2020**

(51) **LOC (13) Cl.** ..... **08-08**

(52) **U.S. Cl.**  
USPC ..... **D6/556**

(58) **Field of Classification Search**

USPC ..... D6/556, 553, 566, 403–405, 557–558,  
D6/692.4, 406, 571; D3/304, 307, 315;  
D11/143–156, 164; 24/555; 47/39, 43 R,  
47/44, 44 R, 44 L, 47 F, 47 R, 47 S, 47 L;  
D8/1

CPC . A47G 7/02; A47G 7/04; A47G 7/041; A47G  
7/042; A47G 7/044; A47G 7/045; A47G  
7/047; A47G 7/06; A47G 7/063; A47G  
7/08; A47G 2007/048; A01G 2009/003;  
A01G 9/02; A01G 9/021; A01G 9/022;  
A01G 9/026; A01G 9/028; A01G 9/029;  
A01G 9/0293; A01G 9/0299; A01G  
9/033; A01G 9/04; A01G 9/045; A01G  
9/047

See application file for complete search history.

(56) **References Cited**

**U.S. PATENT DOCUMENTS**

4,757,641 A \* 7/1988 Penrod ..... A47G 7/044  
248/27.8  
D406,978 S \* 3/1999 Cox ..... D6/556

D419,810 S \* 2/2000 John ..... D6/556  
D510,846 S \* 10/2005 Hardy ..... D8/1  
D670,547 S \* 11/2012 Gorzo ..... D8/1  
D717,566 S \* 11/2014 Nelson ..... D6/556  
D802,331 S \* 11/2017 Harihar ..... D6/558  
D820,723 S \* 6/2018 Giemza ..... D11/164  
D842,757 S \* 3/2019 Ward ..... D11/143  
D845,661 S \* 4/2019 McGehee ..... D6/405  
D860,671 S \* 9/2019 Lawson ..... D6/403  
D886,486 S \* 6/2020 Ripoll ..... D6/403

\* cited by examiner

*Primary Examiner* — Mark Booker

(74) *Attorney, Agent, or Firm* — Dale J. Ream

(57) **CLAIM**

The ornamental design for a plant support device, as shown and described.

**DESCRIPTION**

FIG. 1 is a perspective view of a plant support device showing my new design;  
FIG. 2 is a front view thereof;  
FIG. 3 is a back view thereof;  
FIG. 4 is a left side view thereof;  
FIG. 5 is a right side view thereof;  
FIG. 6 is a top view thereof;  
FIG. 7 is a bottom view thereof; and,  
FIG. 8 is a perspective view thereof shown mounted to a pole.  
In the drawings, the broken lines represent unclaimed environment subject matter and form no part of the claimed design.

**1 Claim, 4 Drawing Sheets**

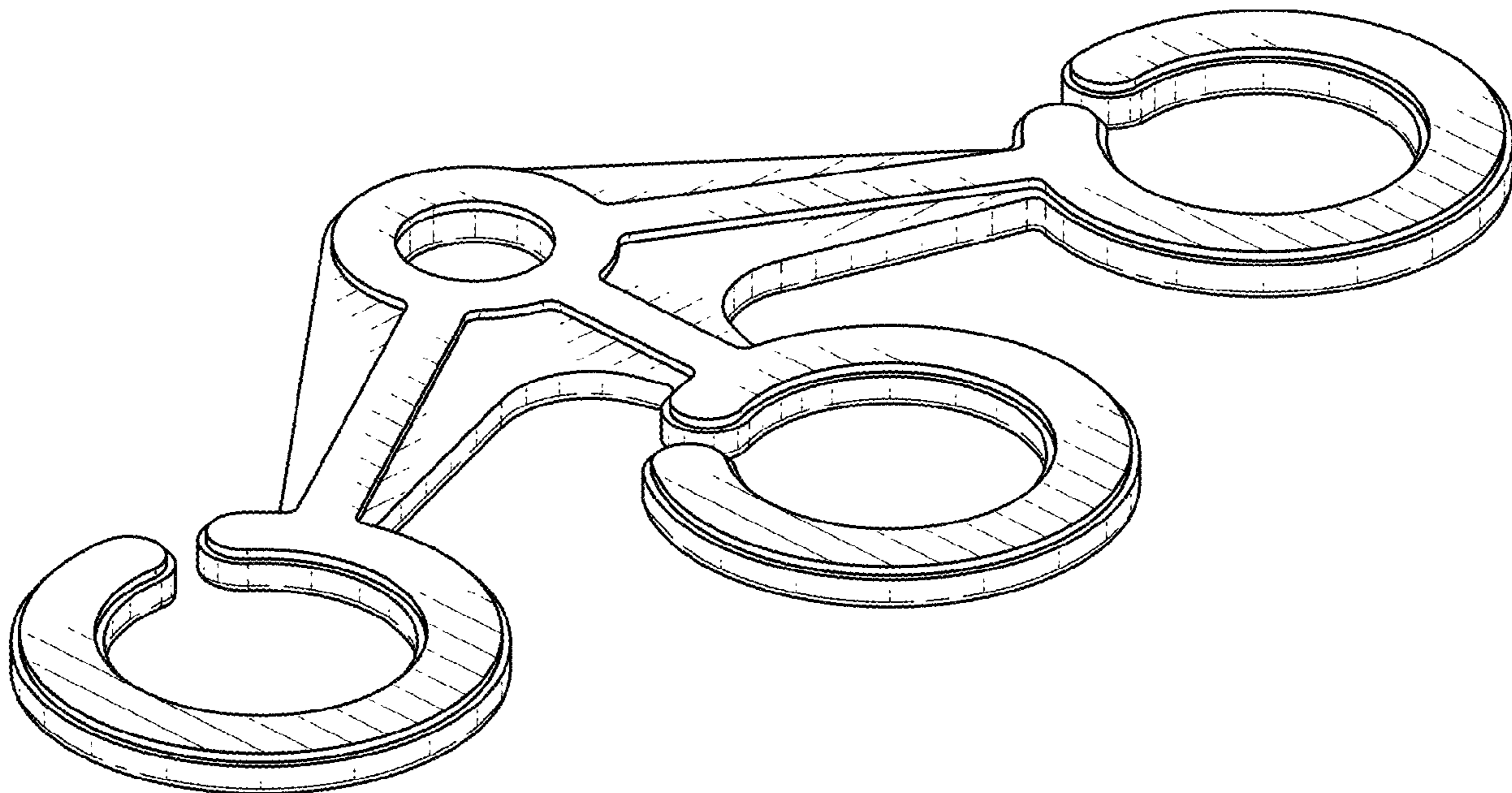

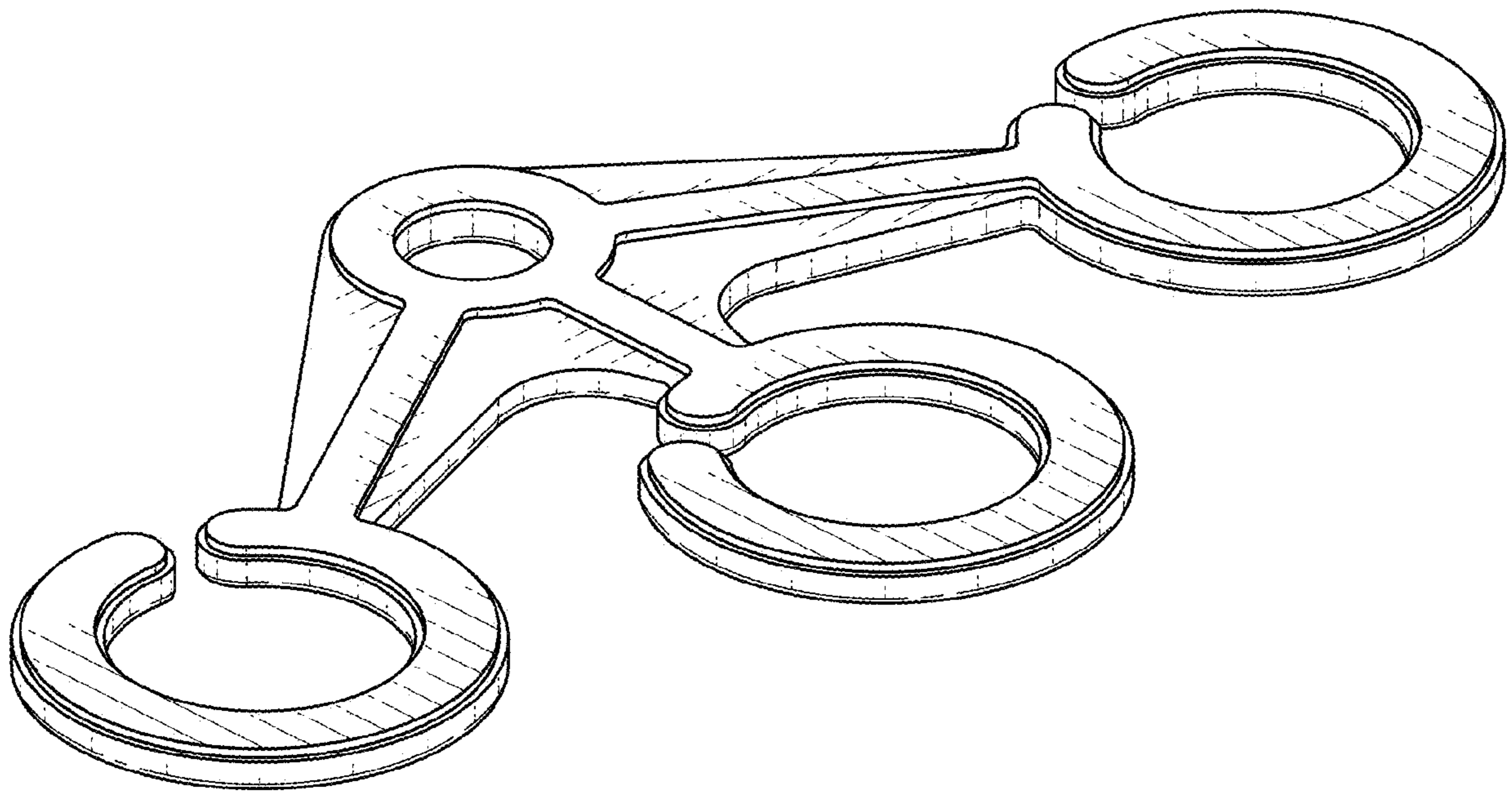

FIG. 1

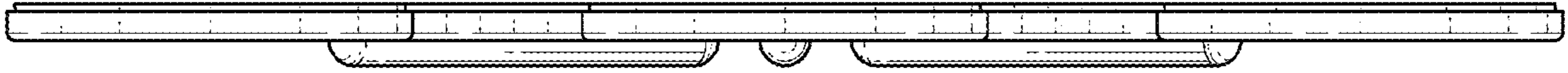

FIG. 2



FIG. 3



FIG. 4

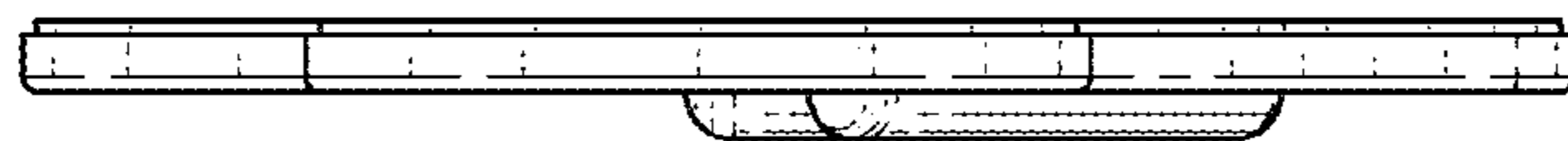

FIG. 5

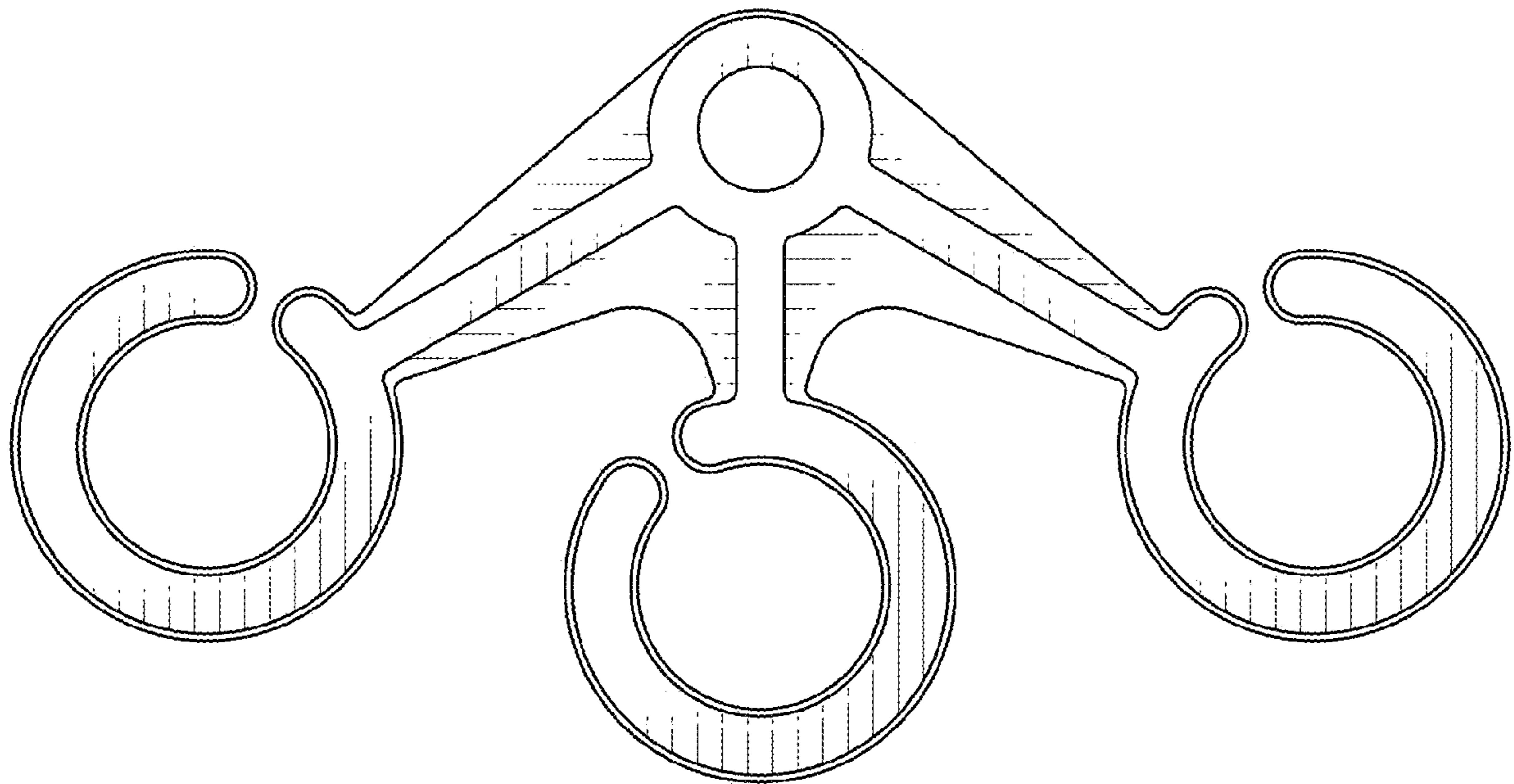

FIG. 6

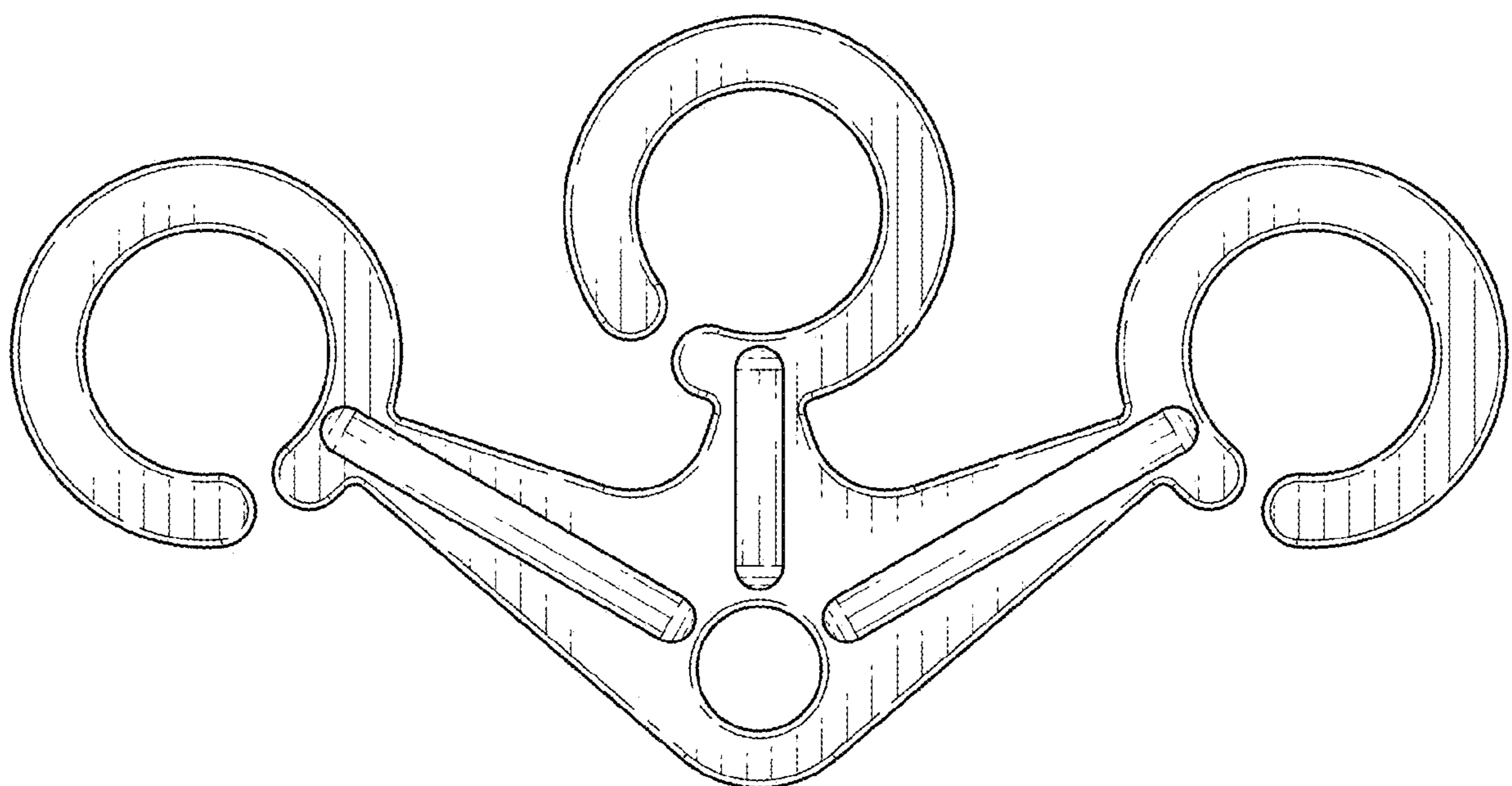

FIG. 7

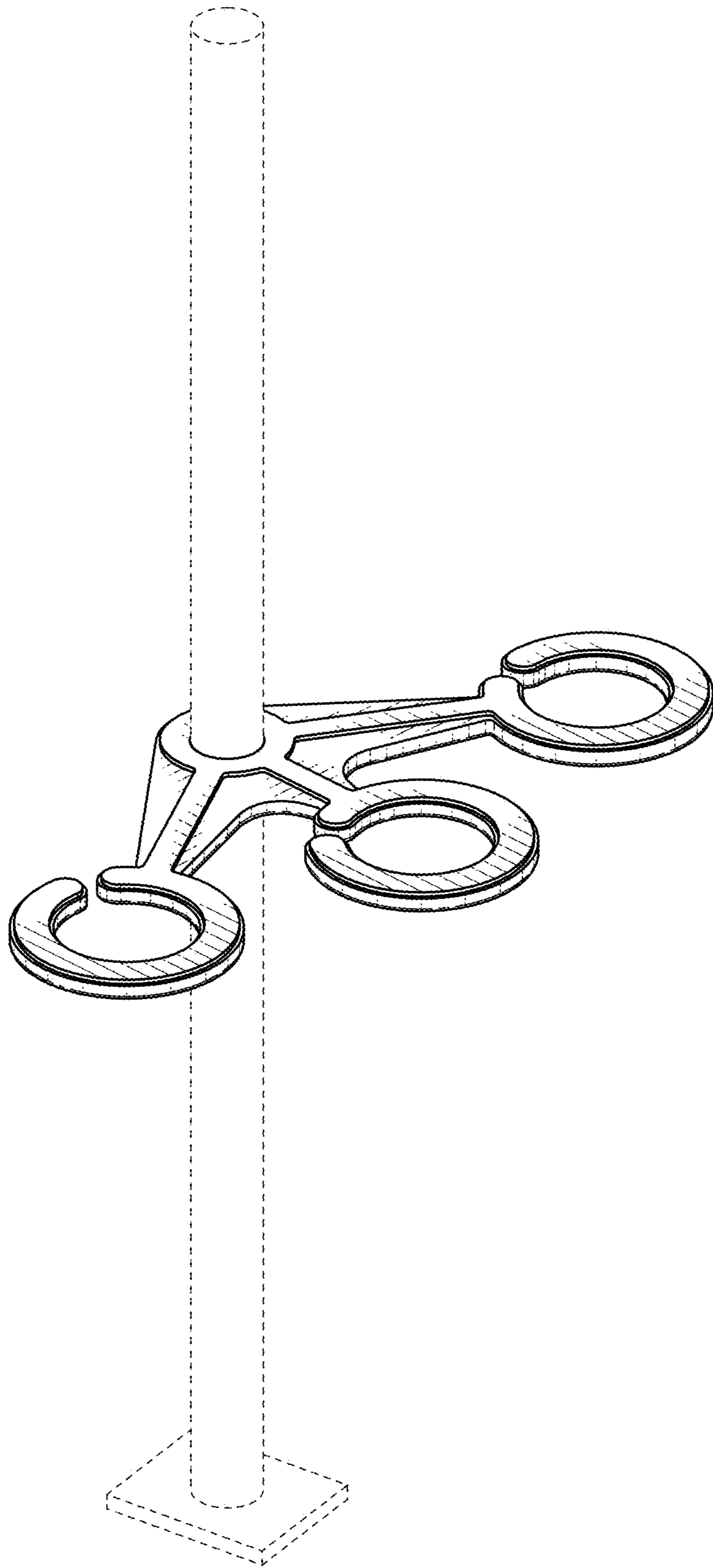

FIG. 8