



US00D916505S

(12) **United States Design Patent** (10) **Patent No.:** **US D916,505 S**
Zhong (45) **Date of Patent:** **** Apr. 20, 2021**

(54) **TOWEL RING**

(56) **References Cited**

(71) Applicant: **GUANGZHOU XUNTE NETWORK TECHNOLOGY CO., LTD,**
Guangzhou (CN)

U.S. PATENT DOCUMENTS

D441,239 S *	5/2001	Moore	D6/546
D441,582 S *	5/2001	Moore	D6/546
D450,509 S *	11/2001	Gottwald	D6/546
D484,722 S *	1/2004	Goodman	D6/546
D600,960 S *	9/2009	Krumpe	D6/546
D850,149 S	6/2019	Kuc		
D850,150 S	6/2019	Kuc		

(72) Inventor: **Linqiang Zhong,** Guangzhou (CN)

* cited by examiner

(73) Assignee: **GUANGZHOU XUNTE NETWORK TECHNOLOGY CO., LTD,**
Guangzhou (CN)

Primary Examiner — Mark Booker

(**) Term: **15 Years**

(57) **CLAIM**

(21) Appl. No.: **29/741,330**

The ornamental design for a towel ring, as shown and described.

(22) Filed: **Jul. 11, 2020**

DESCRIPTION

(51) **LOC (13) Cl.** **06-04**

(52) **U.S. Cl.**
USPC **D6/546**

(58) **Field of Classification Search**
USPC D6/546, 520, 524, 528–531, 534, 550;
211/13.1, 60.1, 65, 66, 70.6, 89.01;
242/570, 590, 595–598; 248/49, 175,
248/176.1, 200, 201, 205.1, 251, 302,
248/309.1, 315; D8/306

FIG. 1 is a front elevational view of a towel ring showing my new design;
FIG. 2 is a rear elevational view thereof;
FIG. 3 is a left side elevational view thereof;
FIG. 4 is a right side elevational view thereof;
FIG. 5 is a top plan view thereof;
FIG. 6 is a bottom plan view thereof; and,
FIG. 7 is a perspective view thereof.

CPC A47K 5/02; A47K 10/10
See application file for complete search history.

1 Claim, 7 Drawing Sheets

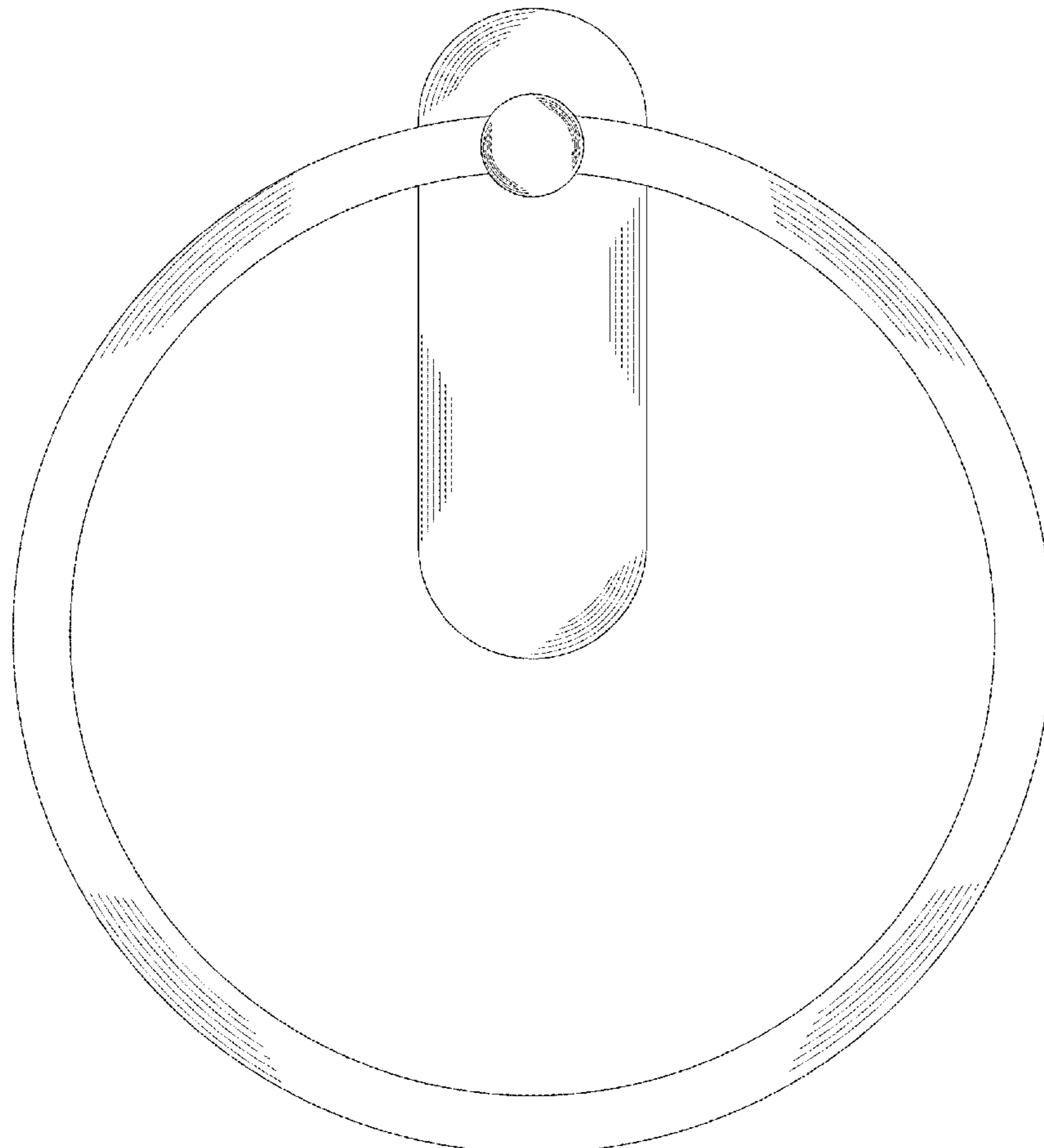

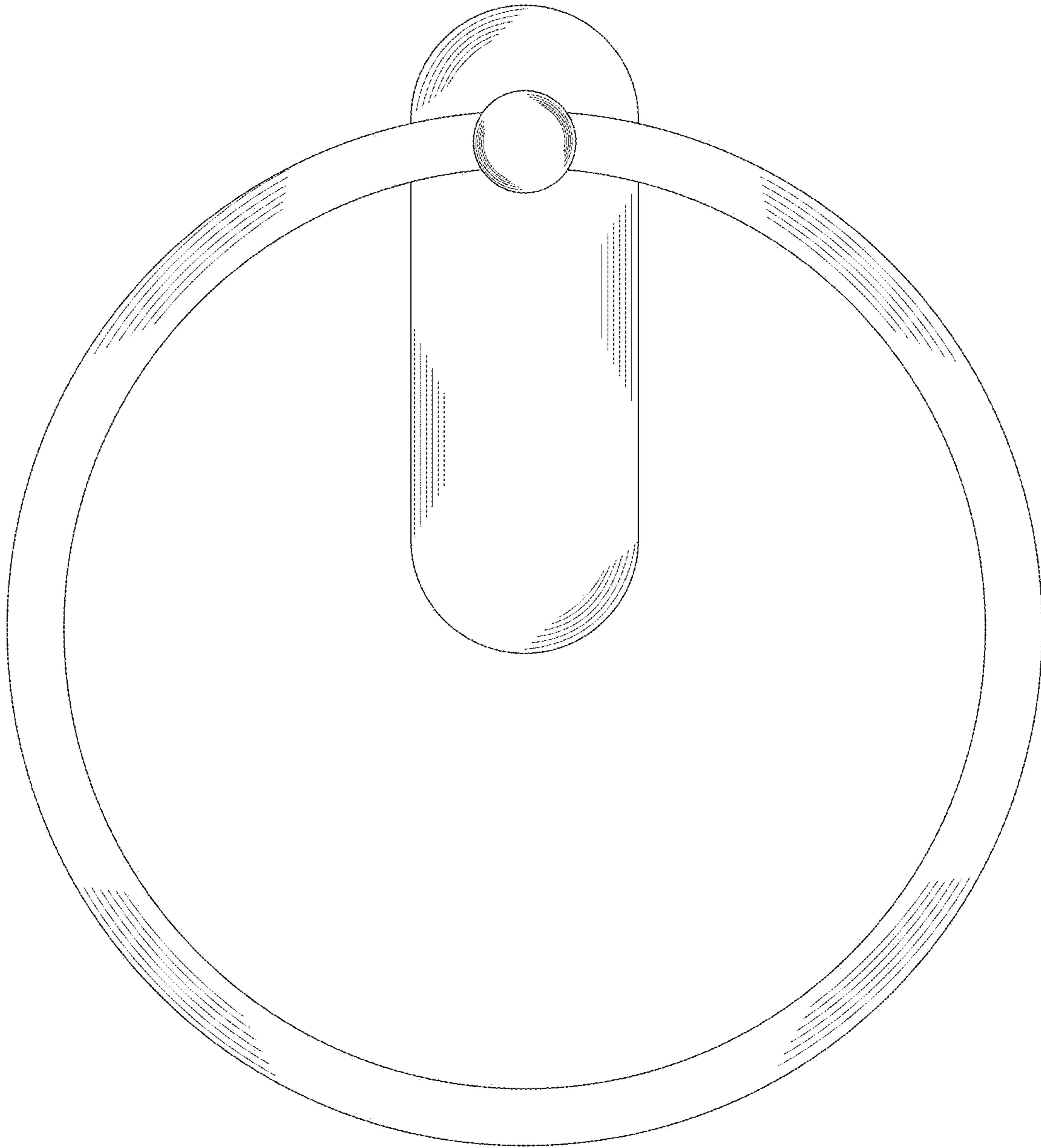

FIG. 1

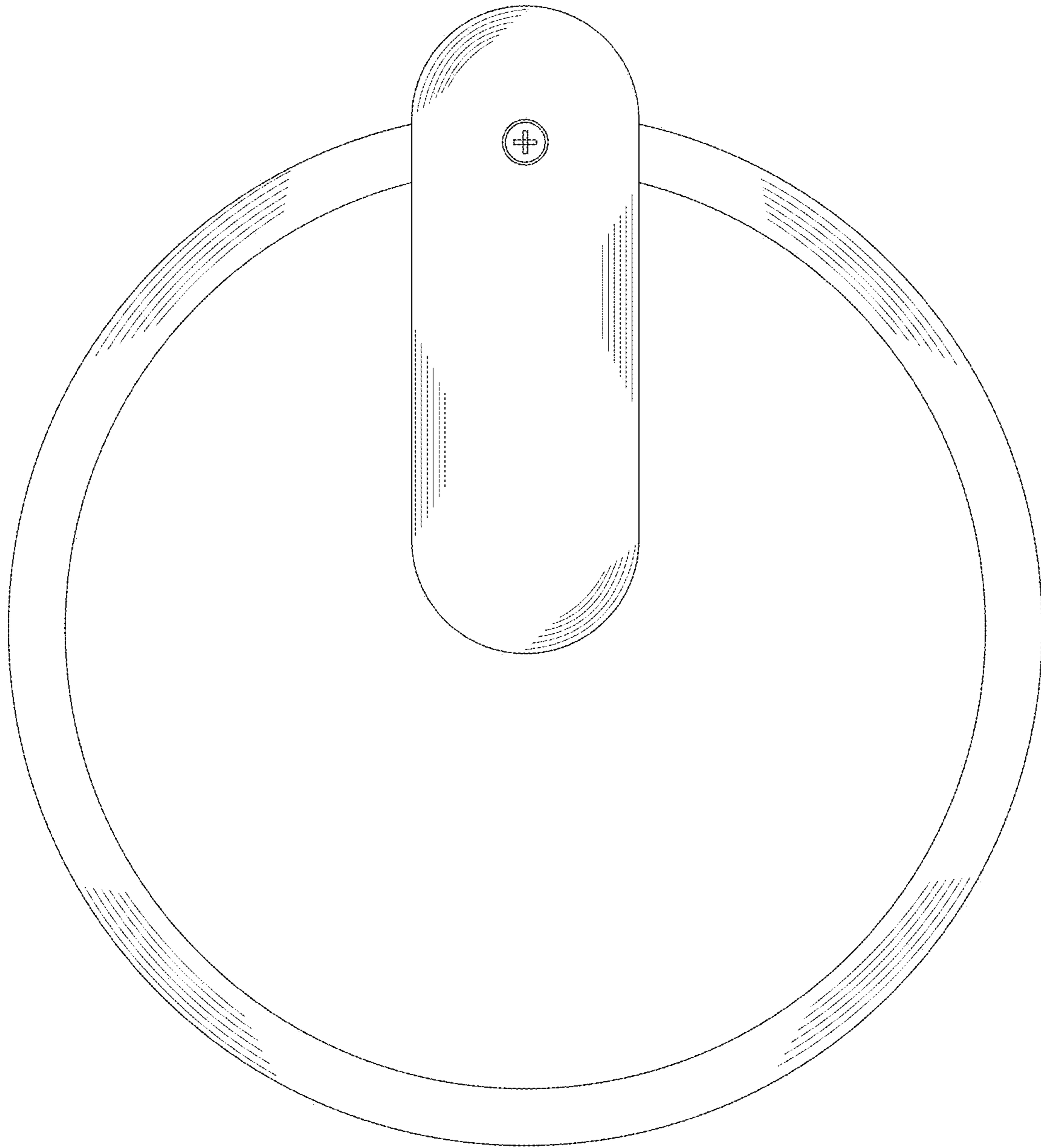

FIG. 2

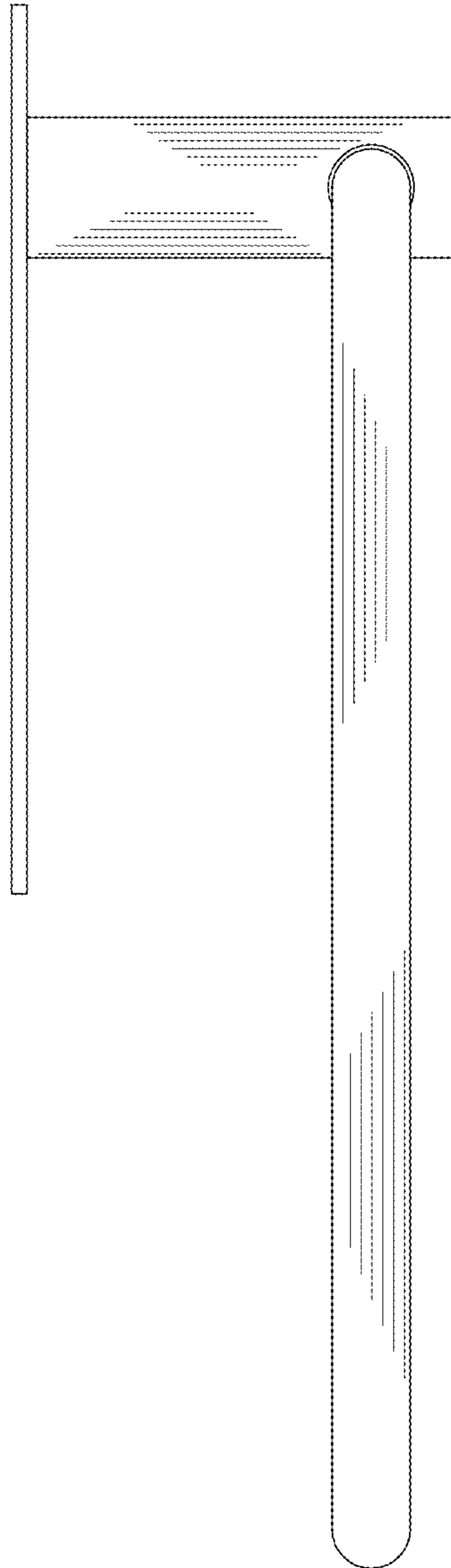

FIG. 3

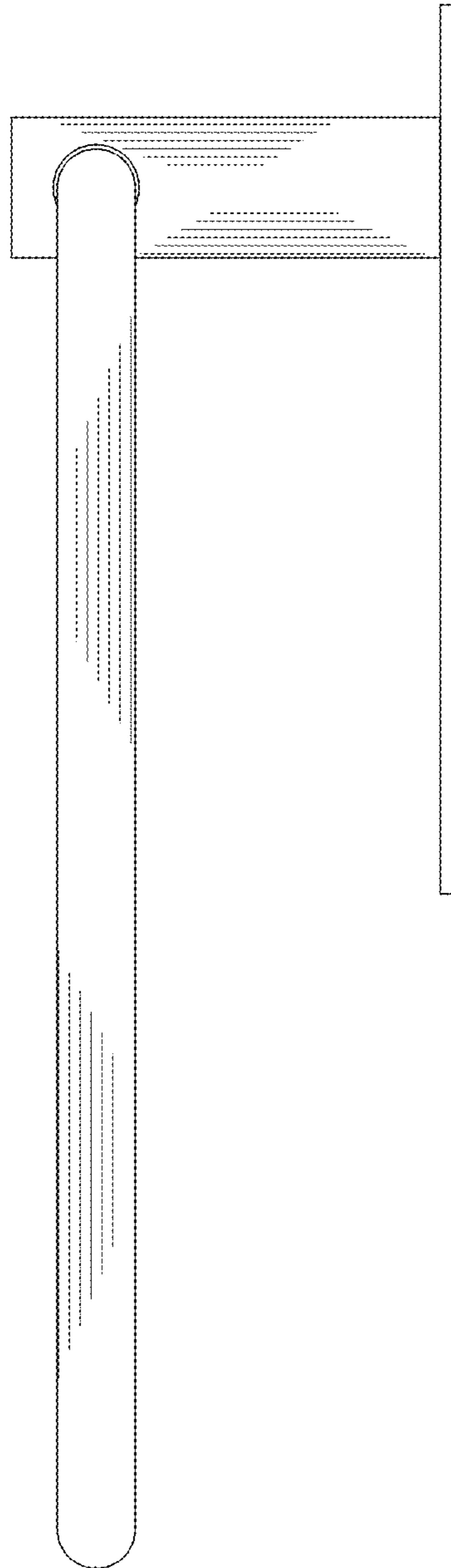

FIG. 4

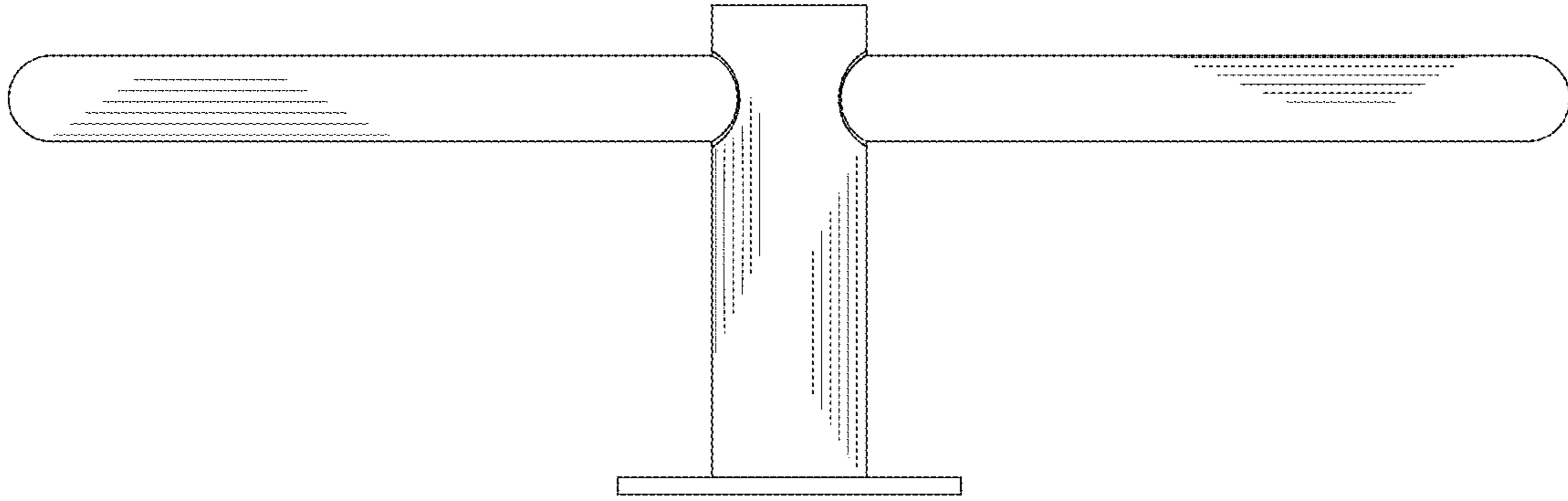

FIG. 5

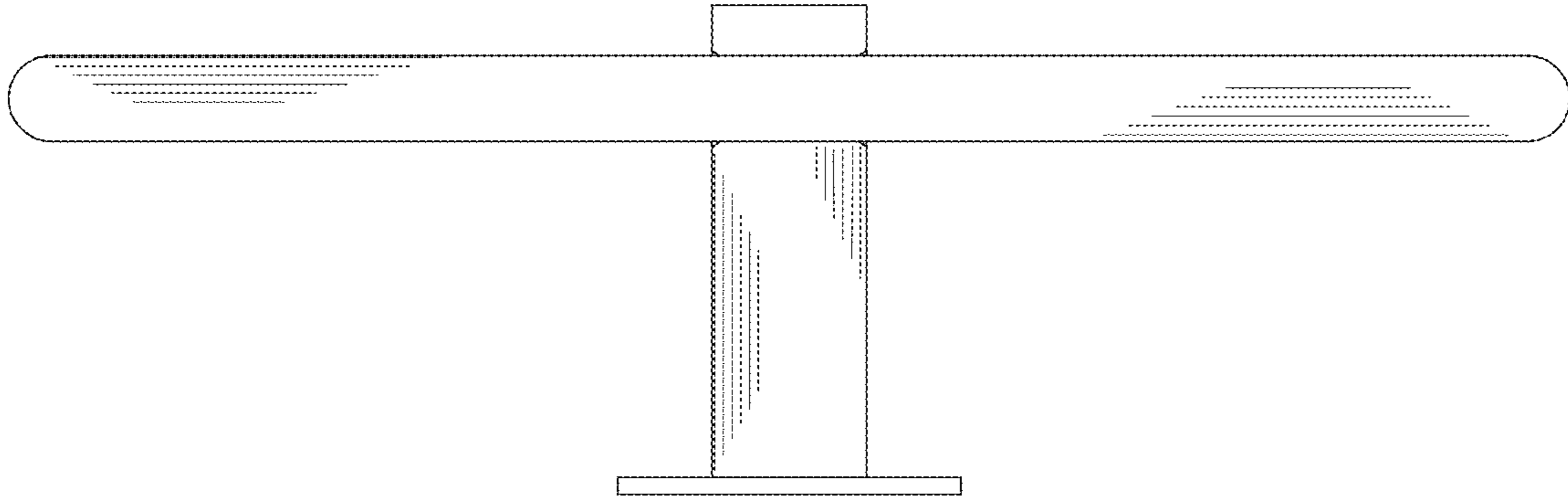

FIG. 6

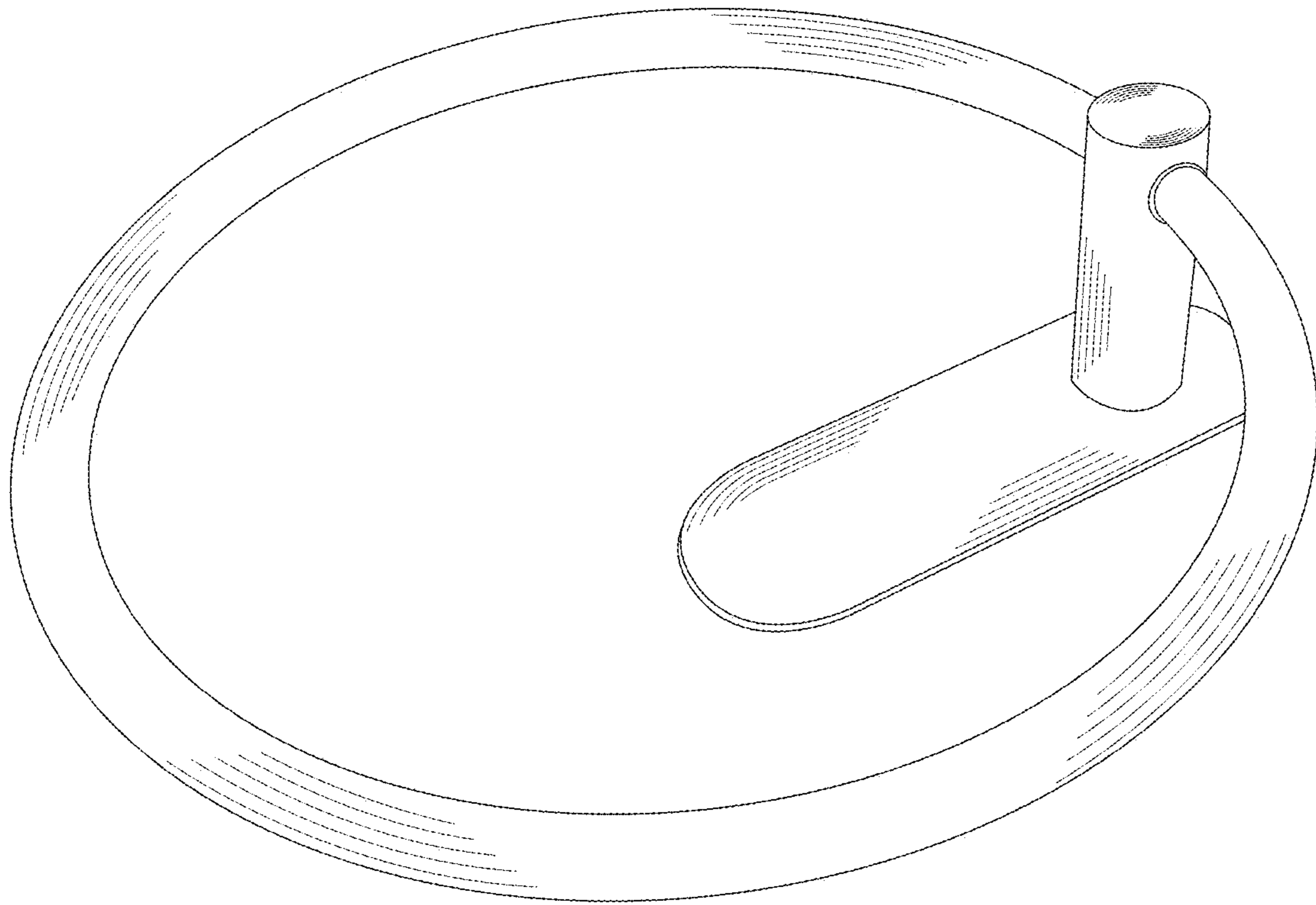

FIG. 7