



US00D916480S

(12) **United States Design Patent** (10) **Patent No.:** **US D916,480 S**
Henderson et al. (45) **Date of Patent:** **** Apr. 20, 2021**

(54) **DOOR-MOUNTED HAND SANITIZER DISPENSER**

(71) Applicant: **Altitude Medical, Inc.**, Chardon, OH (US)

(72) Inventors: **Gregg A. Henderson**, Munroe Falls, OH (US); **Jon Horbaly**, Burke, VA (US); **Ray Dunning**, Concord, OH (US); **Eric Krieger**, Mentor, OH (US); **Jacob McKnight**, Oxfordshire (GB)

(73) Assignee: **Altitude Medical, Inc.**, Chardon, OH (US)

(**) Term: **15 Years**

(21) Appl. No.: **29/640,188**

(22) Filed: **Mar. 12, 2018**

(51) **LOC (13) Cl.** **20-02**

(52) **U.S. Cl.**
USPC **D6/512**

(58) **Field of Classification Search**
USPC D6/512; D8/301, 321, 350, 353;
D23/208, 366, 368; 422/24, 28, 292;
222/30, 192

(Continued)

(56) **References Cited**

U.S. PATENT DOCUMENTS

D552,966 S * 10/2007 Roberts D8/330
8,408,423 B1 * 4/2013 McKnight A61L 2/14
222/180

(Continued)

Primary Examiner — Mark Booker

(74) *Attorney, Agent, or Firm* — Schwegman Lundberg & Woessner, P.A.

(57) **CLAIM**

The ornamental design for a door-mounted hand sanitizer dispenser, as shown and described.

DESCRIPTION

FIG. 1 is a front perspective view of a first embodiment of a door-mounted hand sanitizer dispenser showing our new design;

FIG. 2 is a front elevation view thereof;

FIG. 3 is a rear elevation view thereof;

FIG. 4 is a left side elevation view thereof;

FIG. 5 is a left side elevation view an alternate embodiment of FIG. 1, the only difference being in the configuration of the paddle, it being understood that all other surfaces are same as those in the first embodiment;

FIG. 6 is a left side elevation view an alternate embodiment of FIG. 1, the only difference being in the absence of the paddle, it being understood that all other surfaces are the same as those in the first embodiment thereof;

FIG. 7 is a right side elevation view thereof;

FIG. 8 is a top plan view thereof;

FIG. 9 is a bottom plan view thereof;

FIG. 10 is a front perspective view thereof mounted around a door handle;

FIG. 11 is a front perspective view- thereof mounted on a door around a door handle;

FIG. 12 is a front perspective view of a second embodiment of FIG. 1, the only difference being in the handedness of the door-mounted hand sanitizer dispenser, it being understood that all surfaces are a left-handed mirror image of those of the right-handed first embodiment;

FIG. 13 is a front elevation view of the embodiment in FIG. 10;

FIG. 14 is a rear elevation view of the embodiment in FIG. 10;

FIG. 15 is a left side elevation view of the embodiment in Fig 10;

FIG. 16 is a left side elevation view an alternate embodiment of FIG. 10, the only difference being in the configuration of the paddle, it being understood that all other surfaces are the same as those in the first embodiment;

FIG. 17 is a left side elevation view an alternate embodiment of FIG. 10, the only difference being in the absence of the paddle, it being understood that all other surfaces are the same as those in the first embodiment thereof;

FIG. 18 is a right side elevation view of the embodiment in FIG. 10;

(Continued)

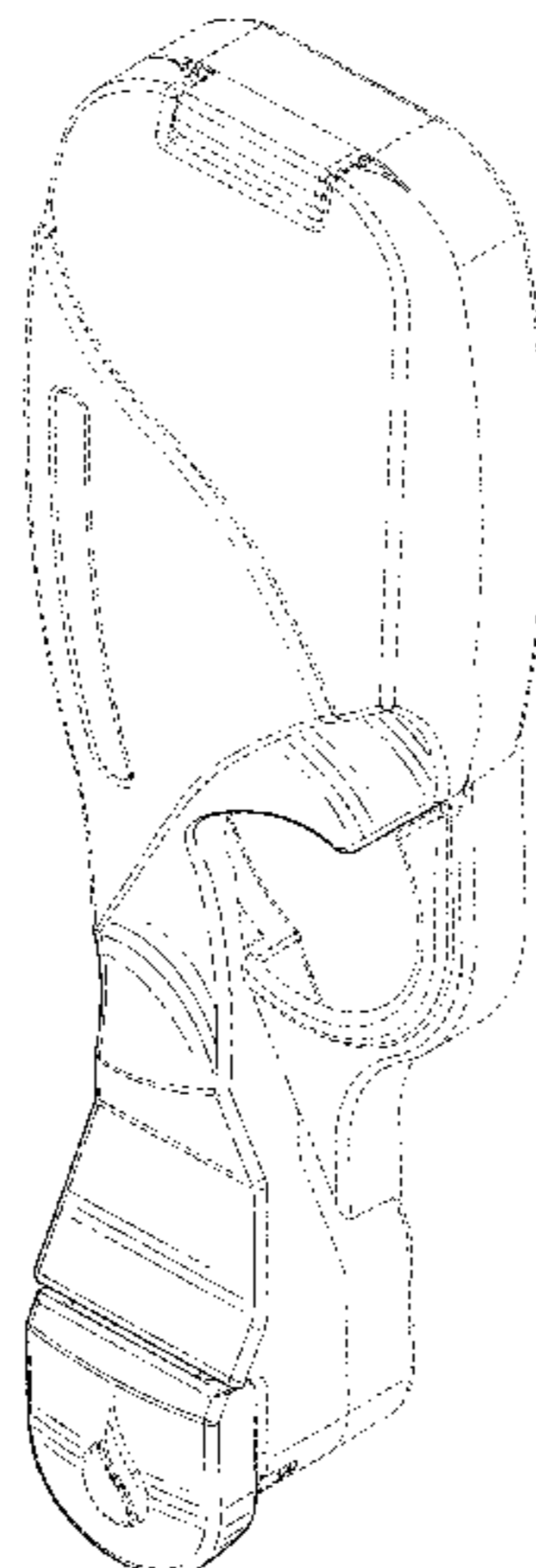

FIG. 19 is a top plan view of the embodiment in FIG. 10; FIG. 20 is a bottom plan view of the embodiment in FIG. 10; FIG. 21 is a front perspective view of the embodiment in FIG. 10 mounted around a door handle; and, FIG. 22 is a front perspective view of the embodiment in FIG. 10 mounted on a door around a door handle. The broken lines shown in the drawings are included for illustrating portions of the door-mounted hand sanitizer dispenser that form no part of the claimed design. The broken lines The ornamental design for a door-mounted hand sanitizer dispenser as shown and described.

1 Claim, 22 Drawing Sheets

(58) **Field of Classification Search**

CPC E05B 1/0069; A61L 2/10; A61L 2/24
See application file for complete search history.

(56)

References Cited

U.S. PATENT DOCUMENTS

8,505,782	B1 *	8/2013	Gardiner	E05B 1/0069 222/181.3
8,636,177	B1 *	1/2014	Gardiner	E05B 1/0069 222/181.3
9,255,423	B2 *	2/2016	Oshmyansky	A61L 2/18
D779,661	S *	2/2017	McKnight	D24/127
D789,704	S *	6/2017	Morrison	D6/512
D839,383	S *	1/2019	York	D23/208
2015/0308149	A1 *	10/2015	Oshmyansky	A61L 2/0088 222/30
2016/0230418	A1 *	8/2016	Allred	B05B 11/3052
2016/0263263	A1 *	9/2016	Robert	A61L 2/14
2017/0318964	A1 *	11/2017	McKnight	A61L 2/22

* cited by examiner

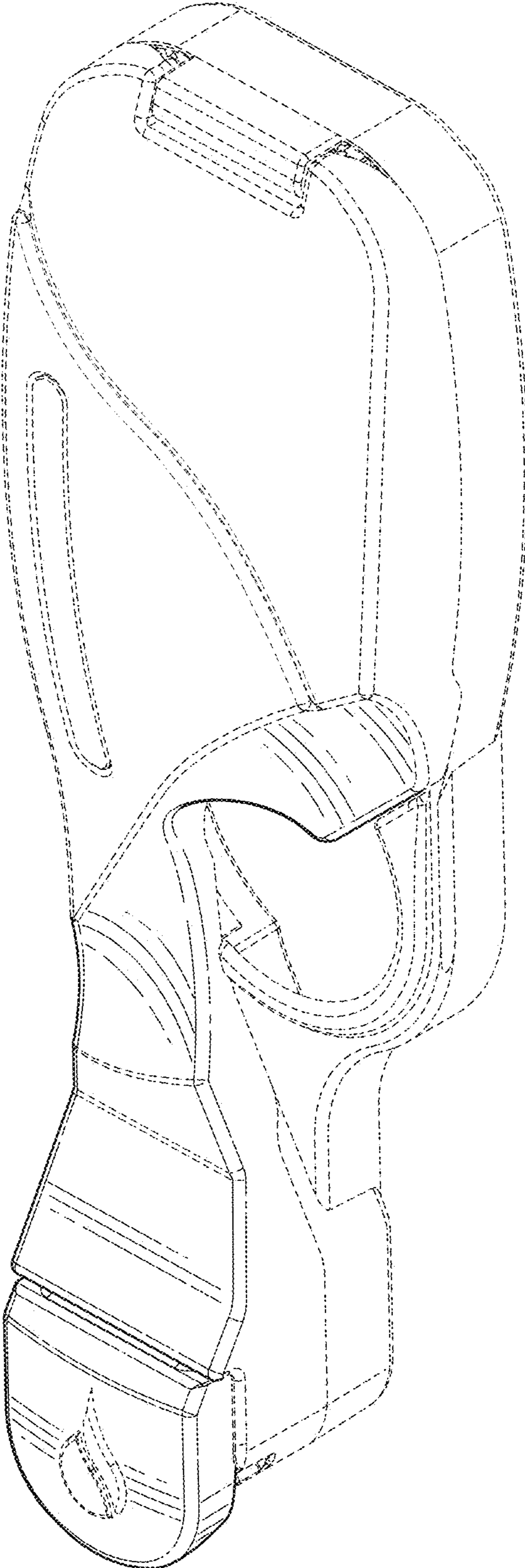

FIG. 1

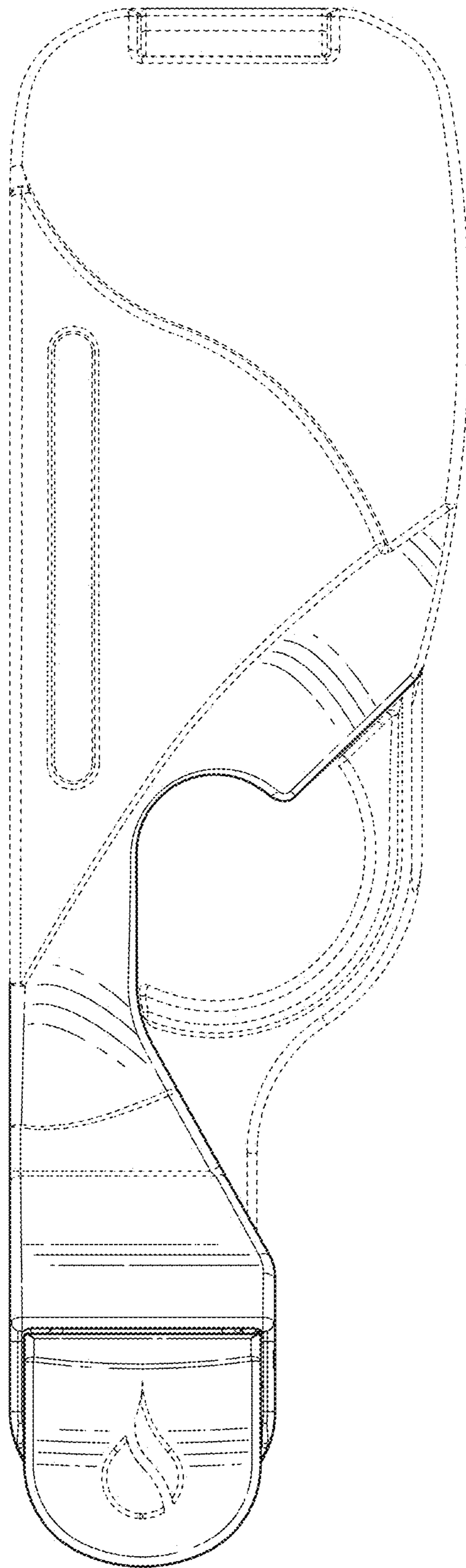

FIG. 2

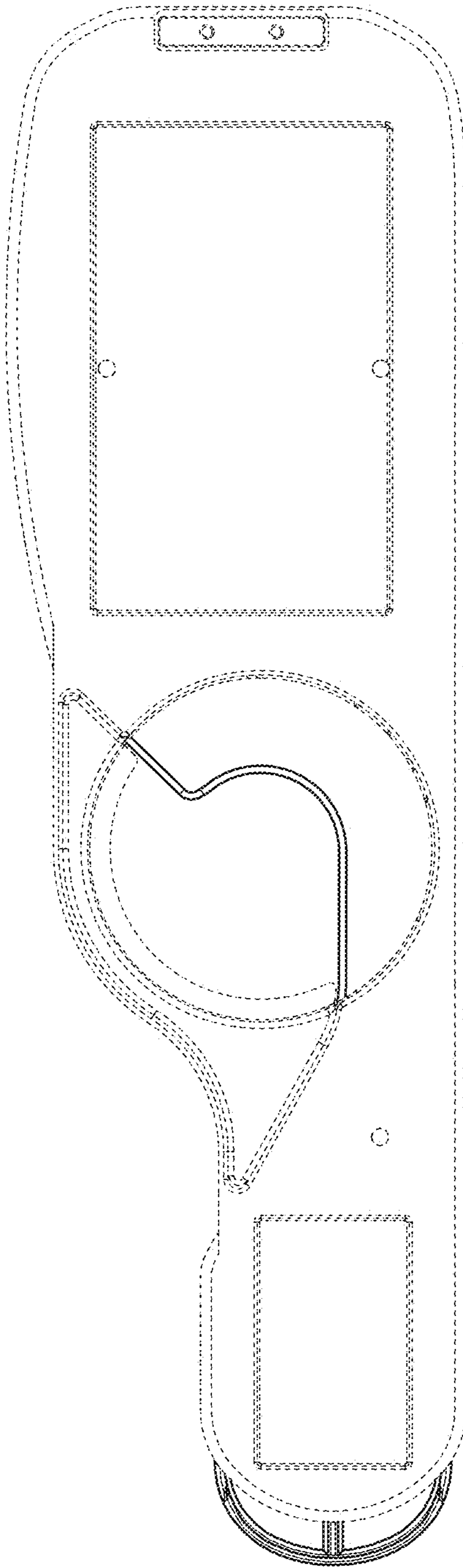

FIG. 3

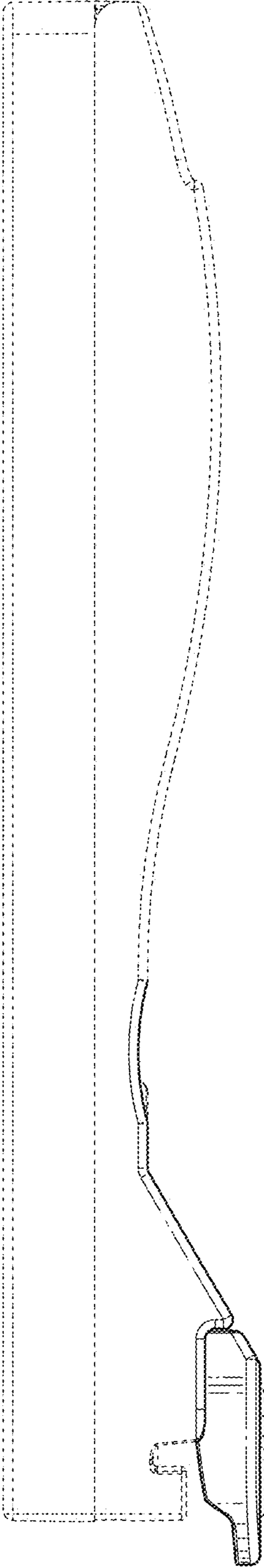

FIG. 4

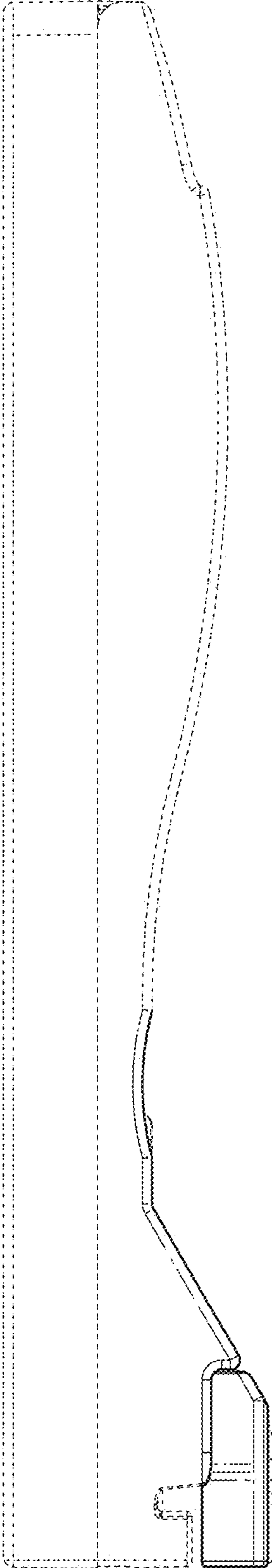

FIG. 5

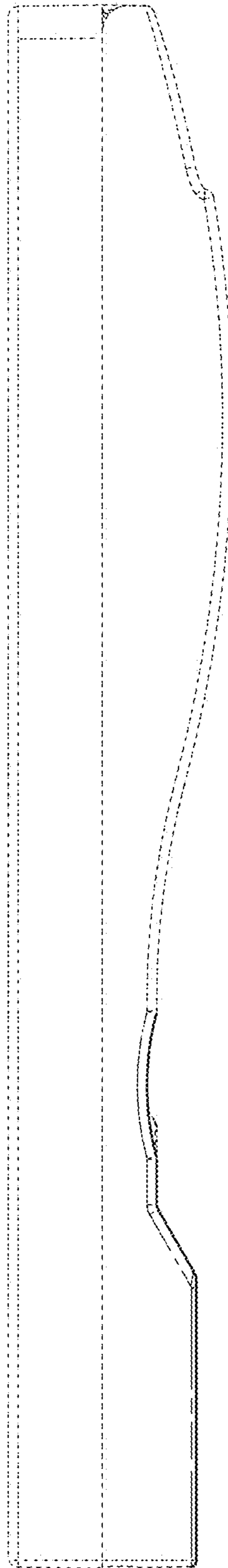

FIG. 6

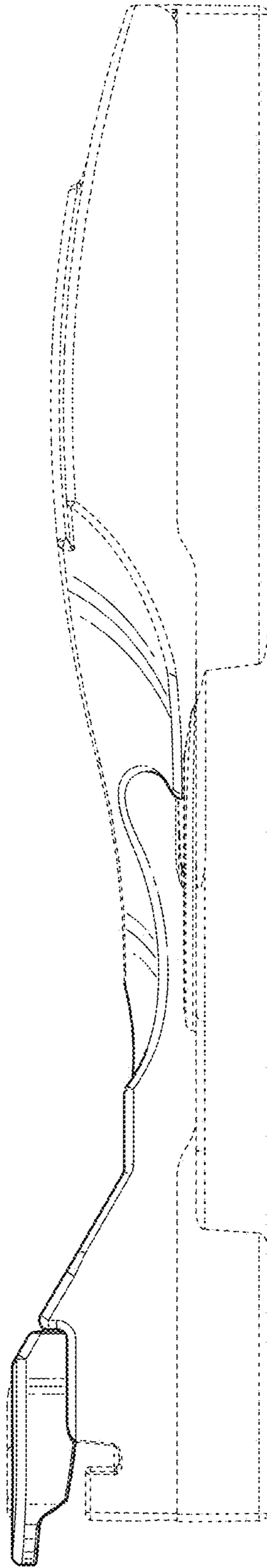

FIG. 7

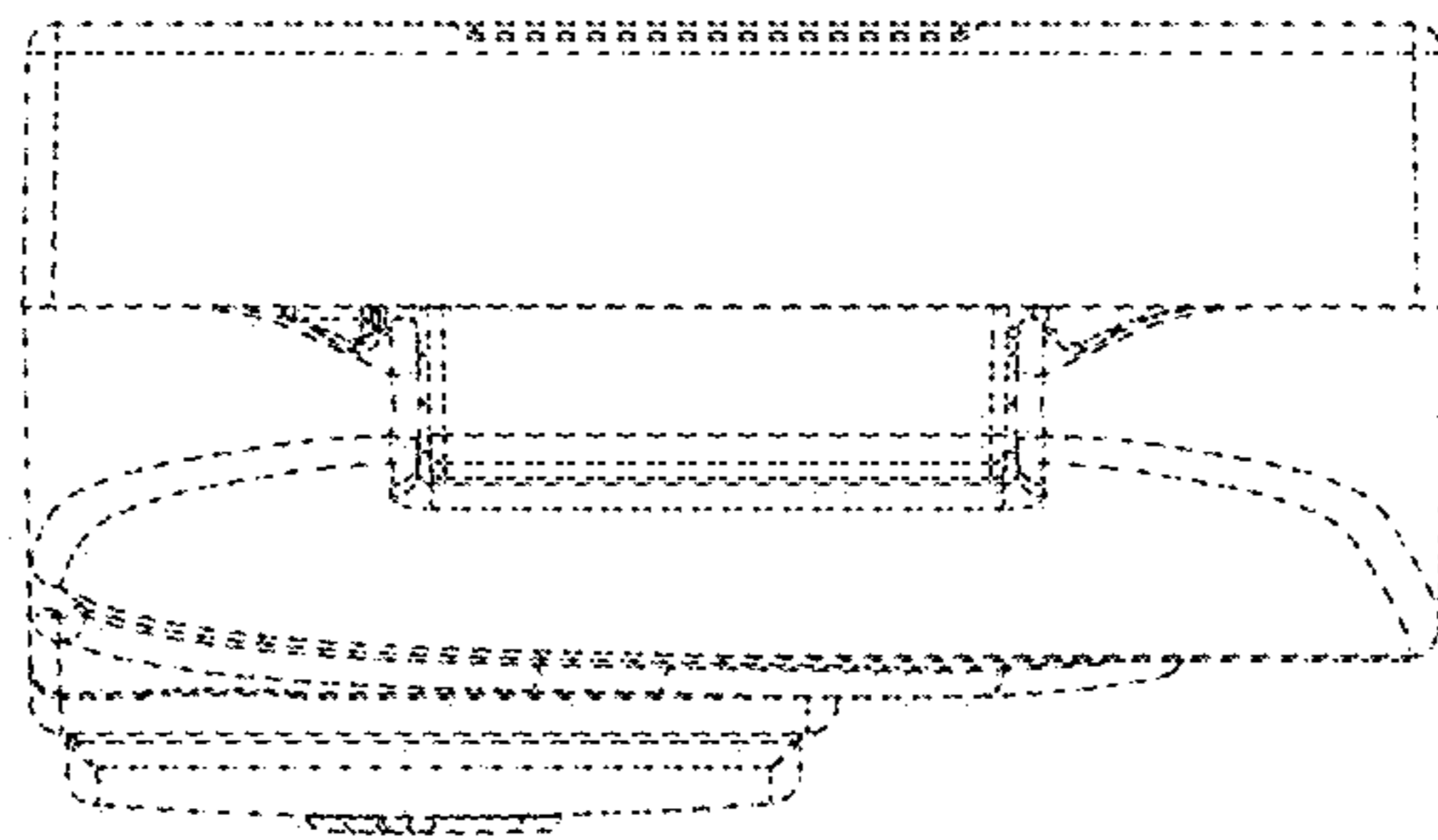

FIG. 8

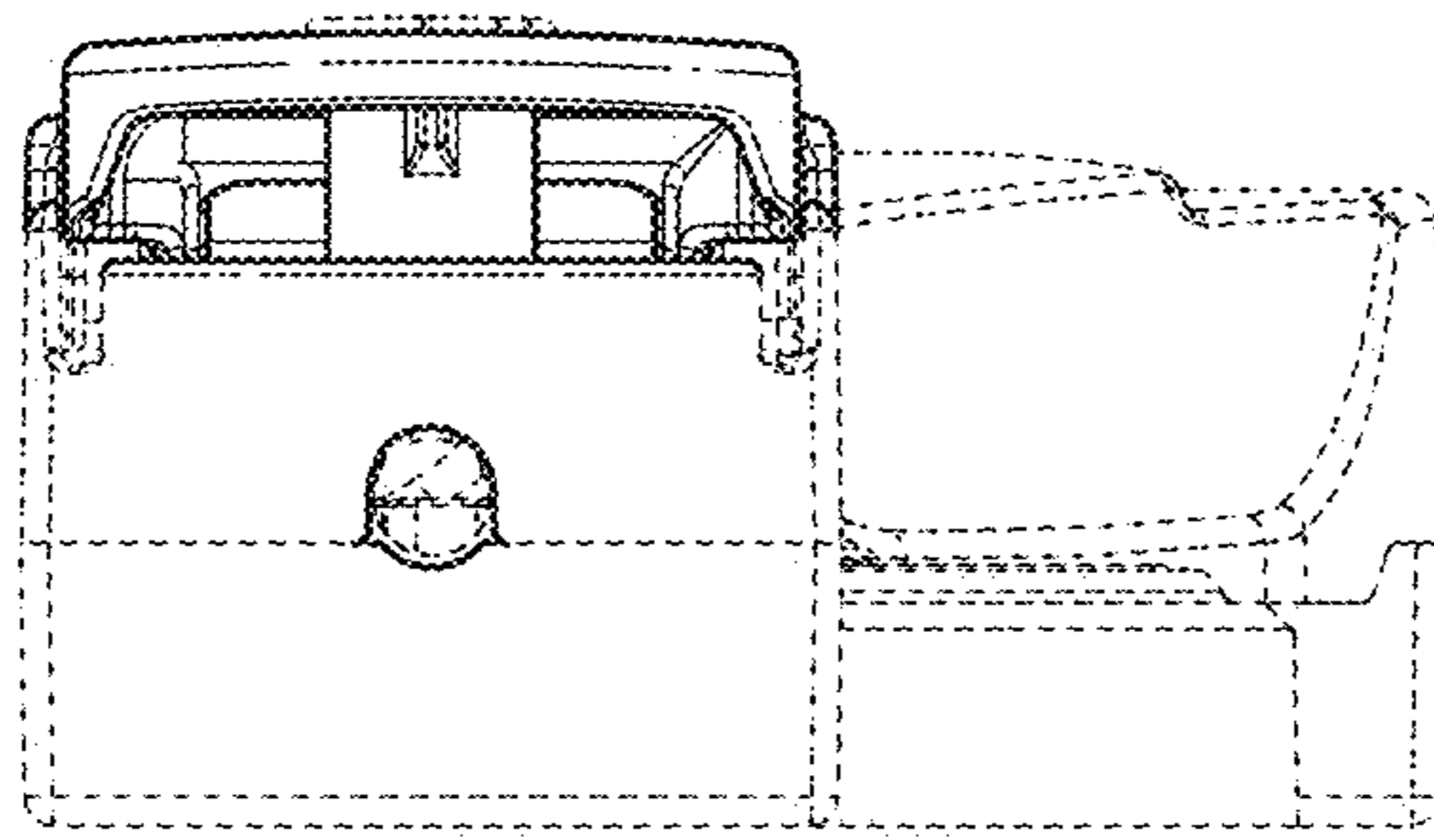

FIG. 9

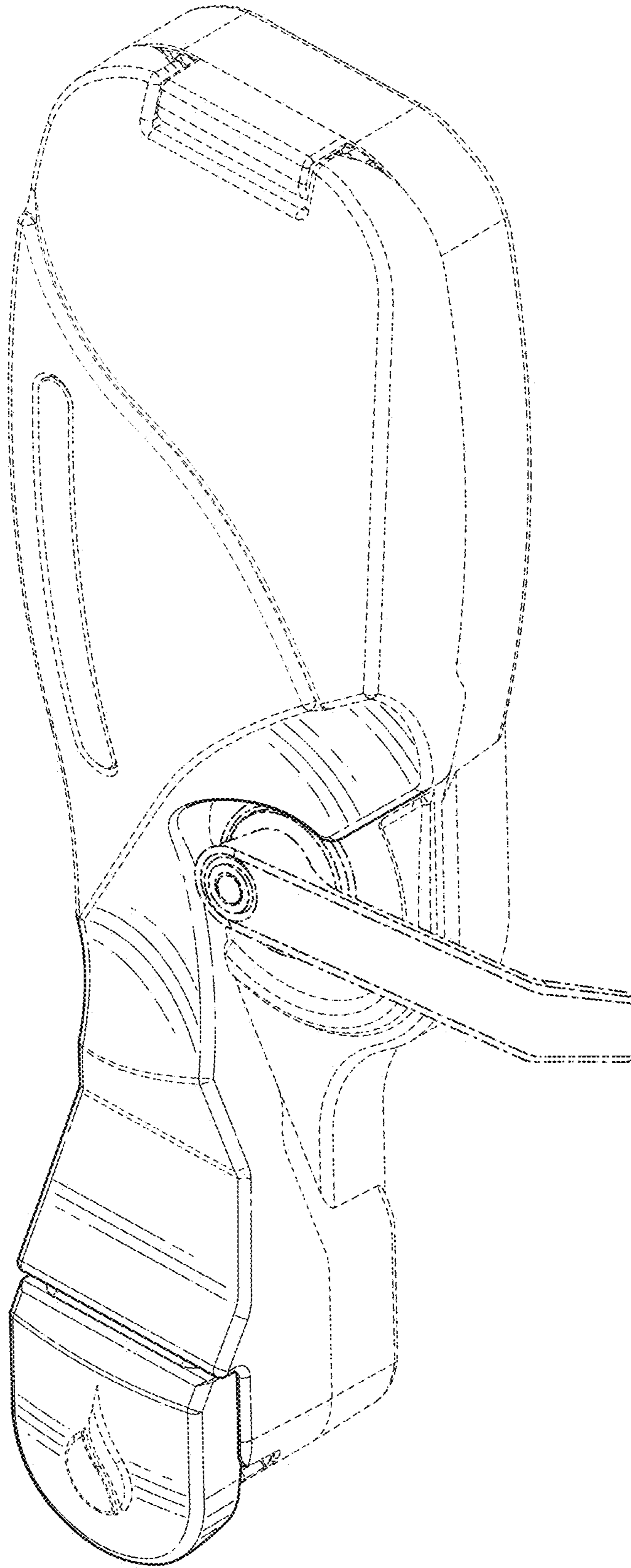

FIG. 10

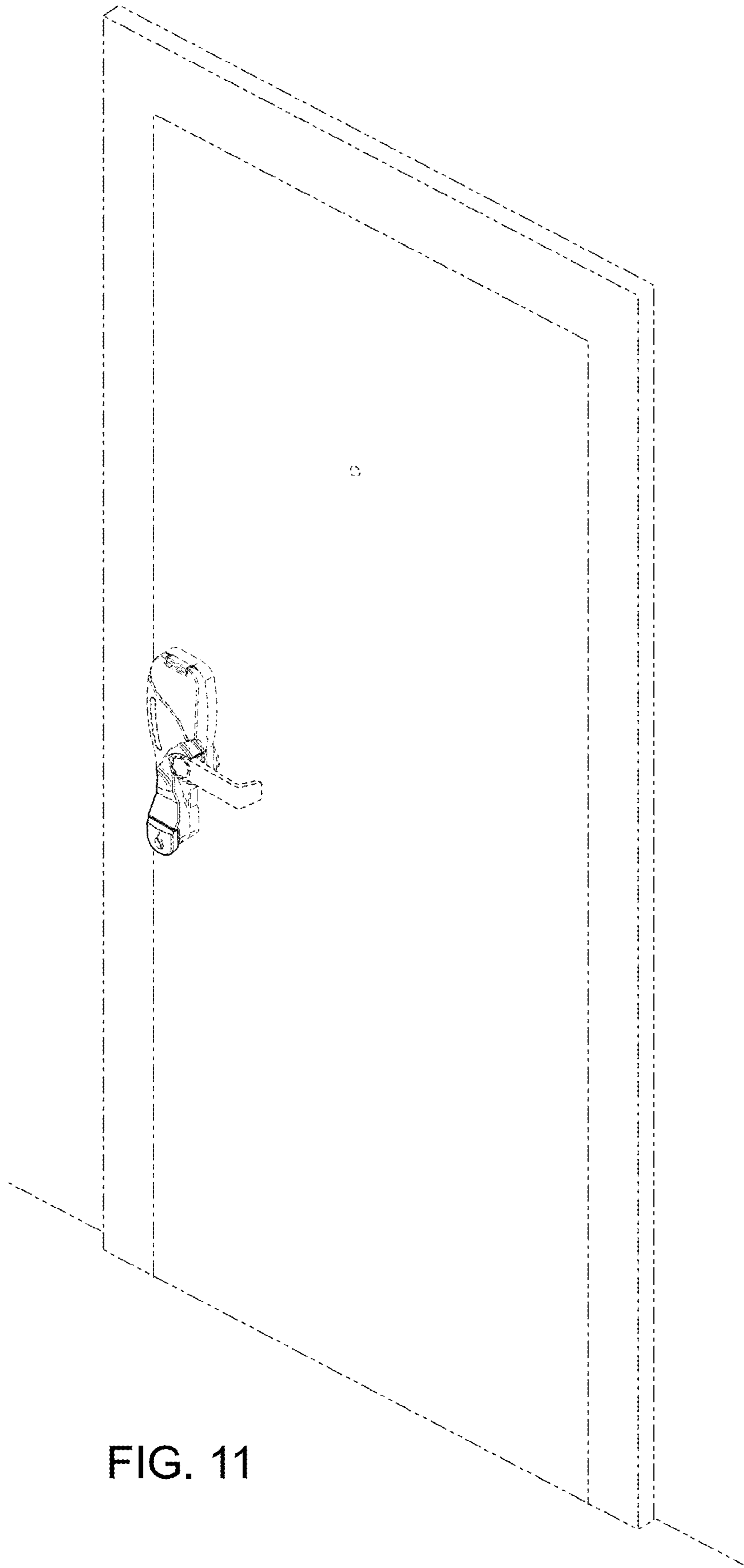

FIG. 11

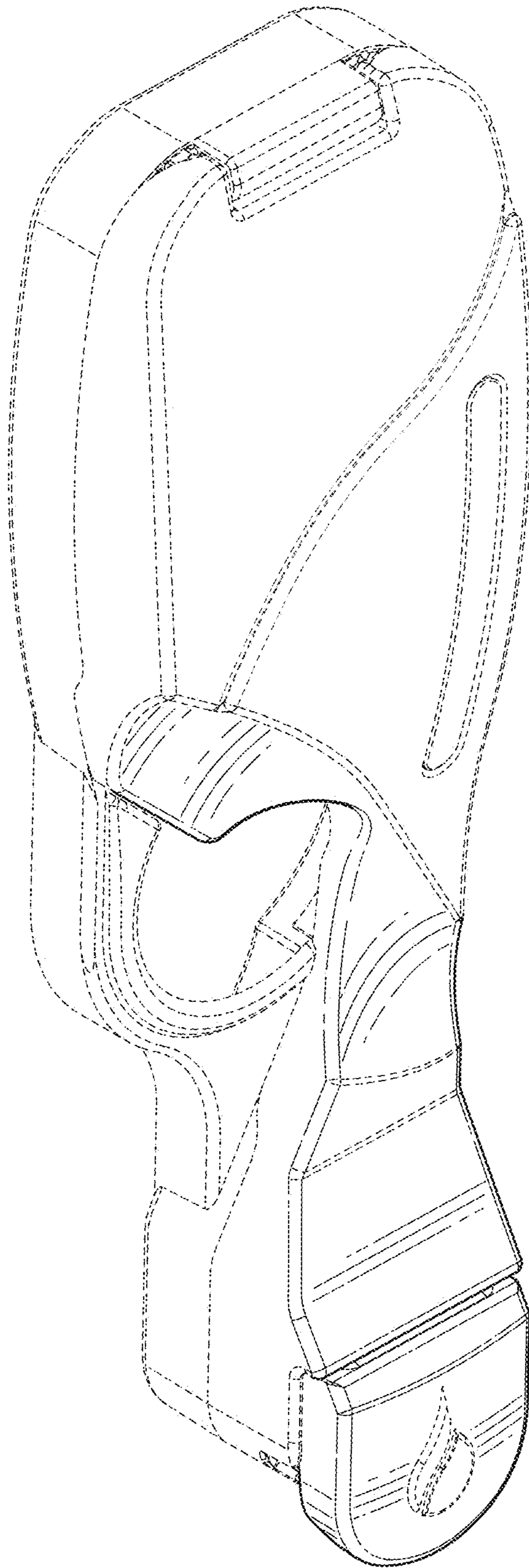

FIG. 12

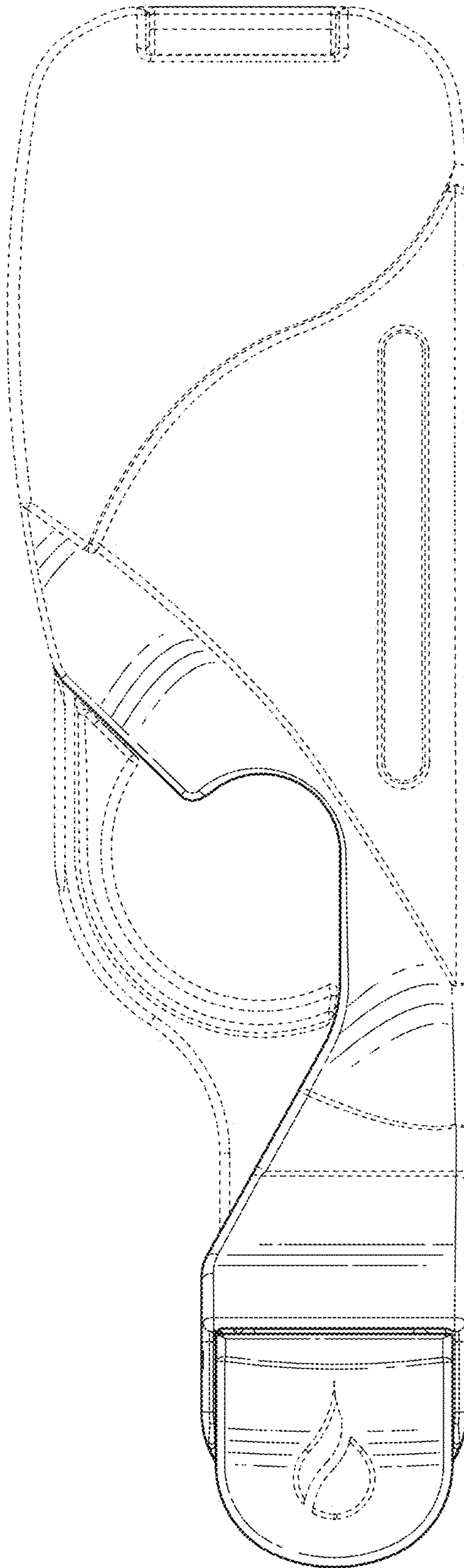

FIG. 13

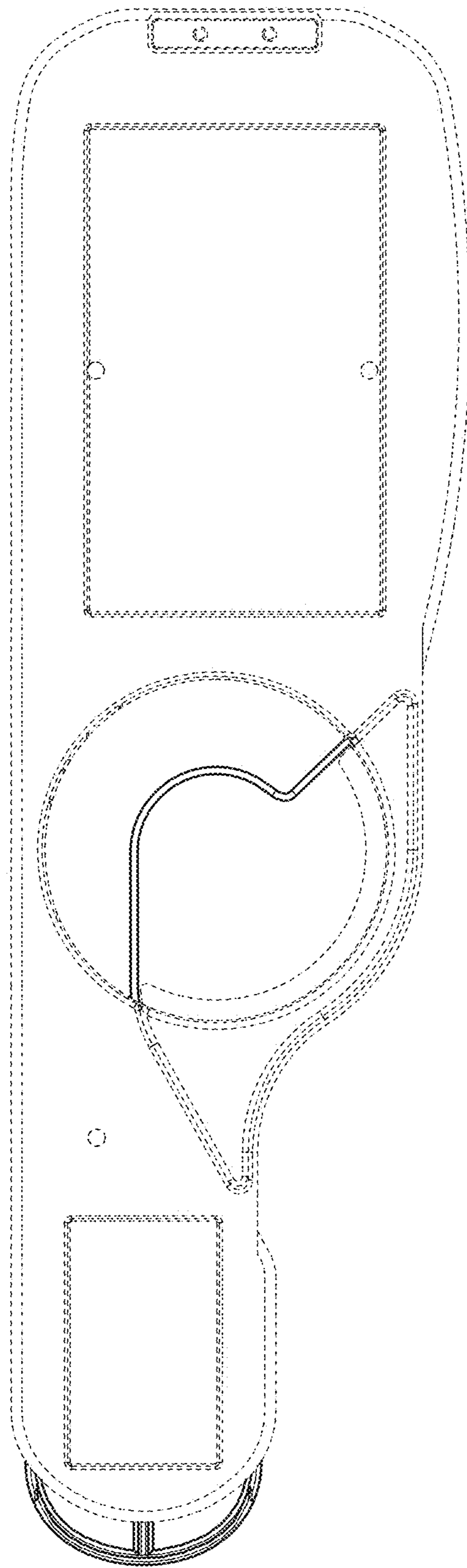

FIG. 14

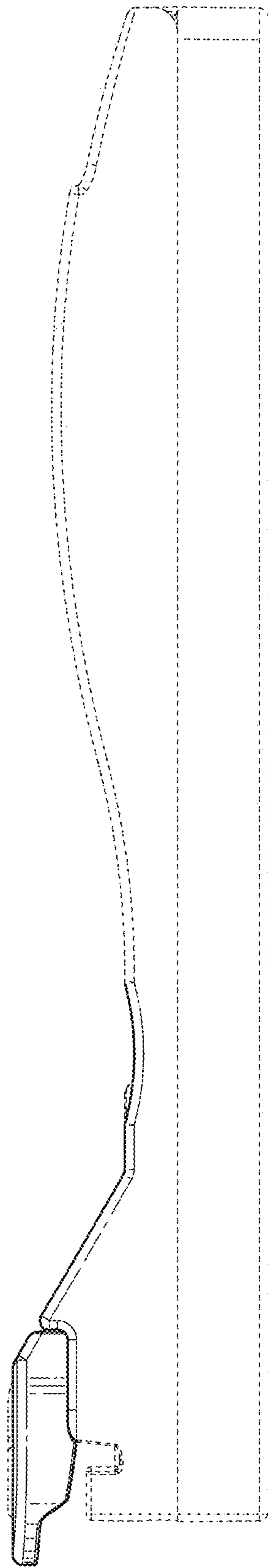

FIG. 15

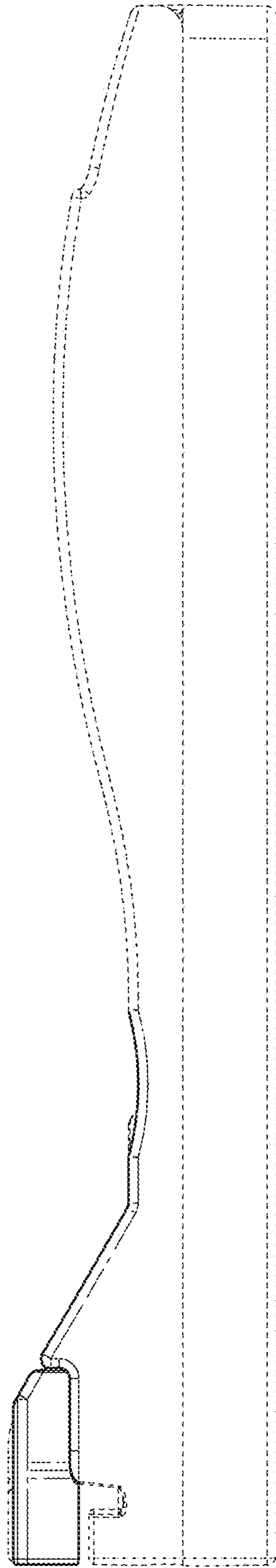

FIG. 16

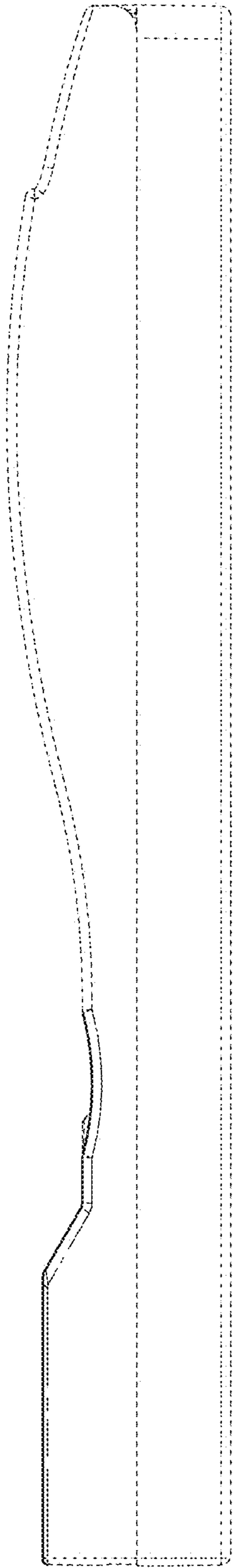

FIG. 17

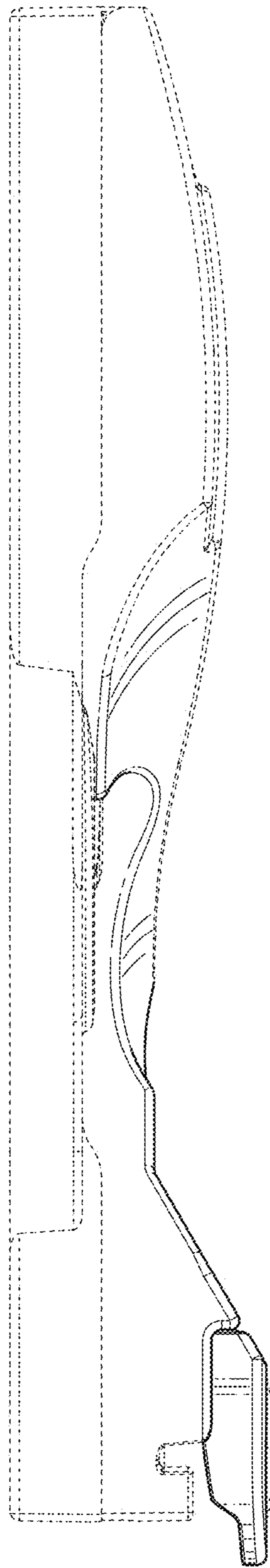

FIG. 18

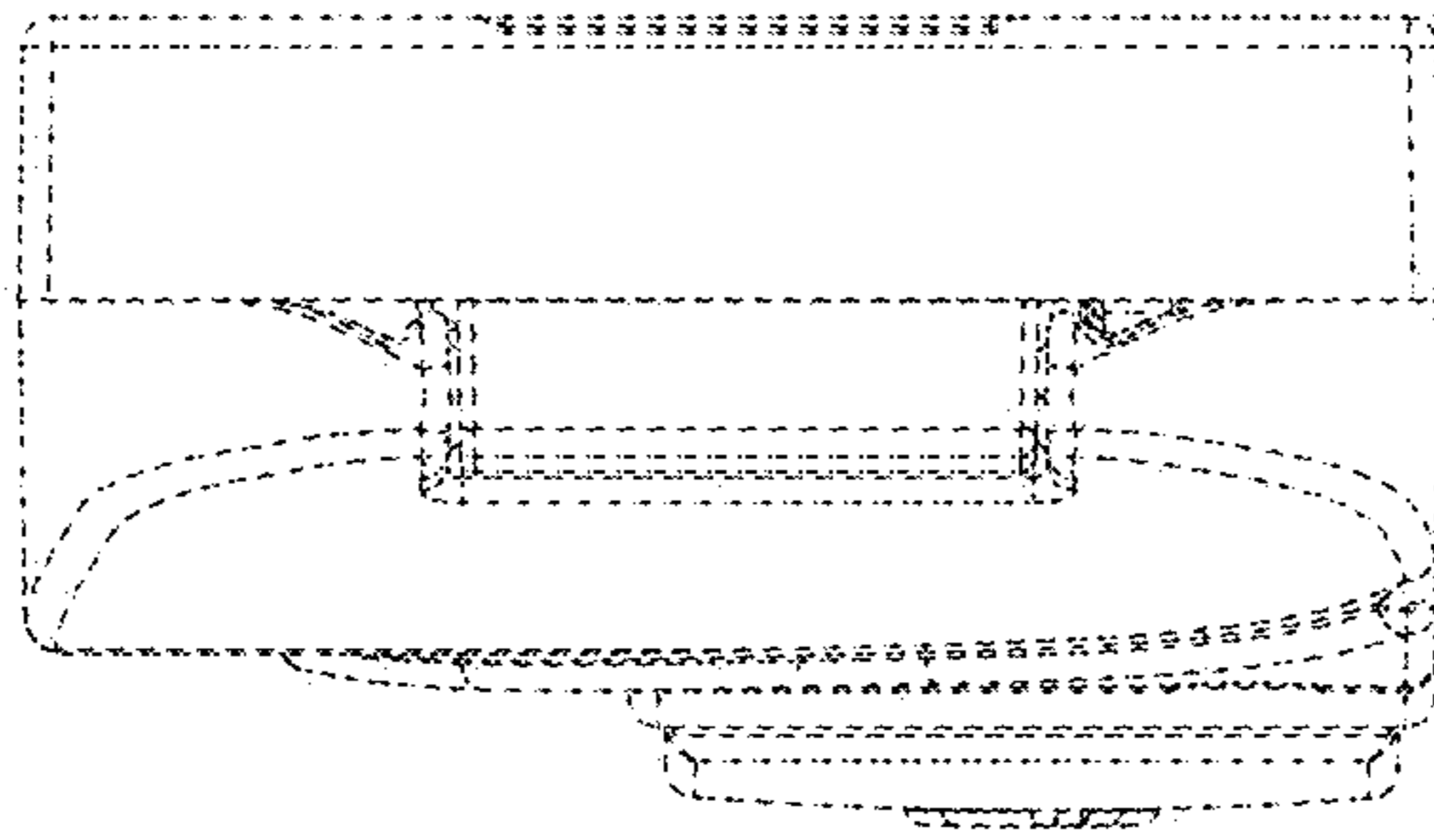

FIG. 19

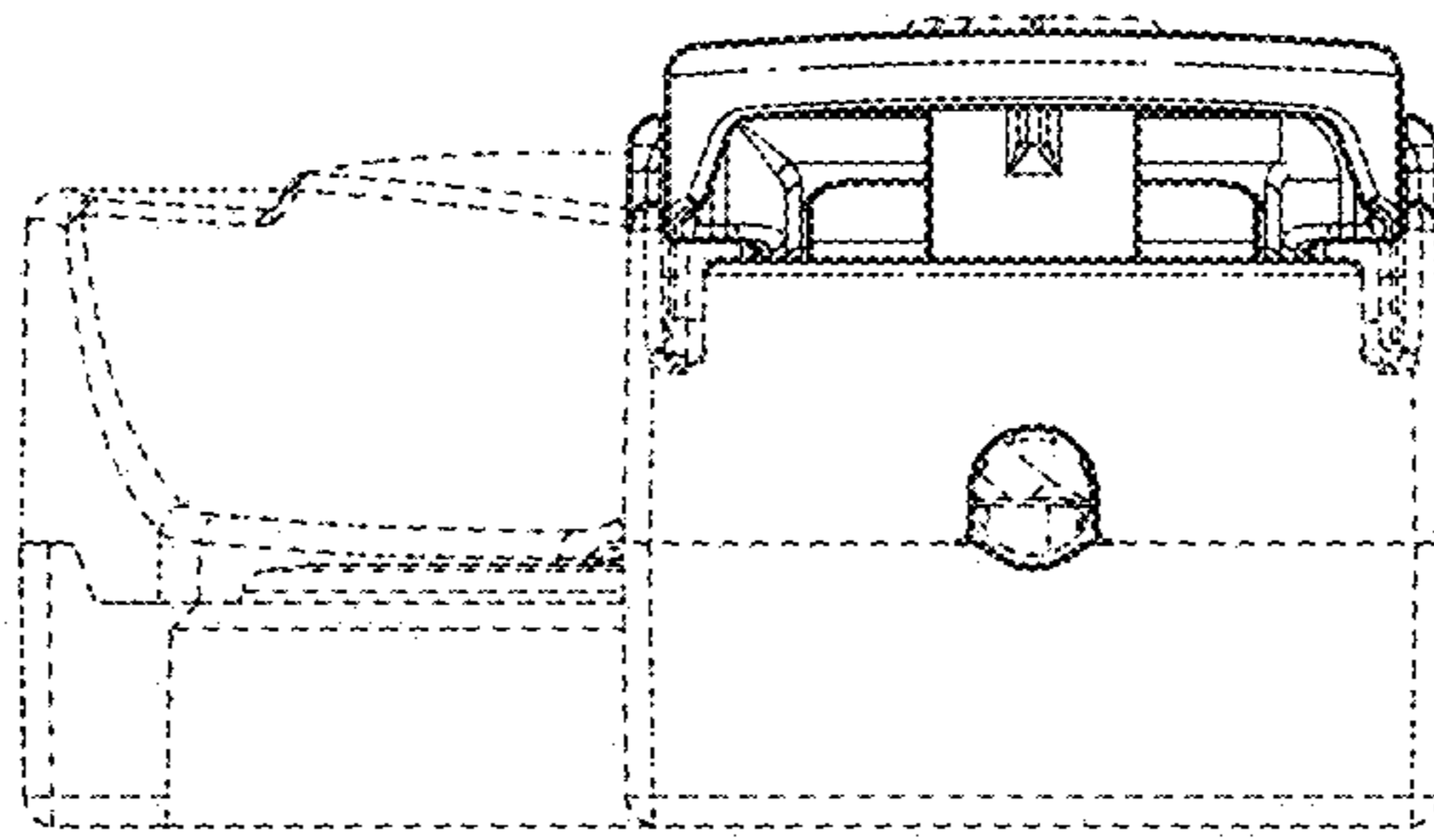

FIG. 20

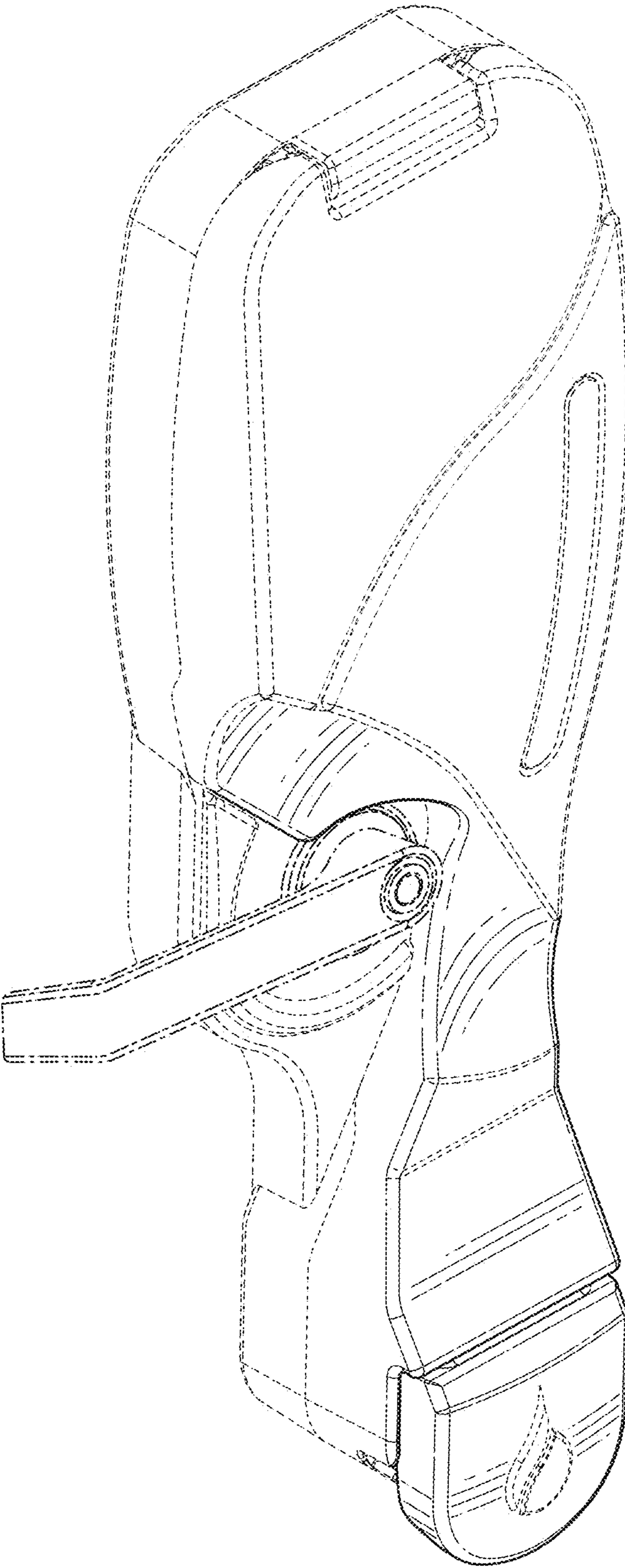

FIG. 21

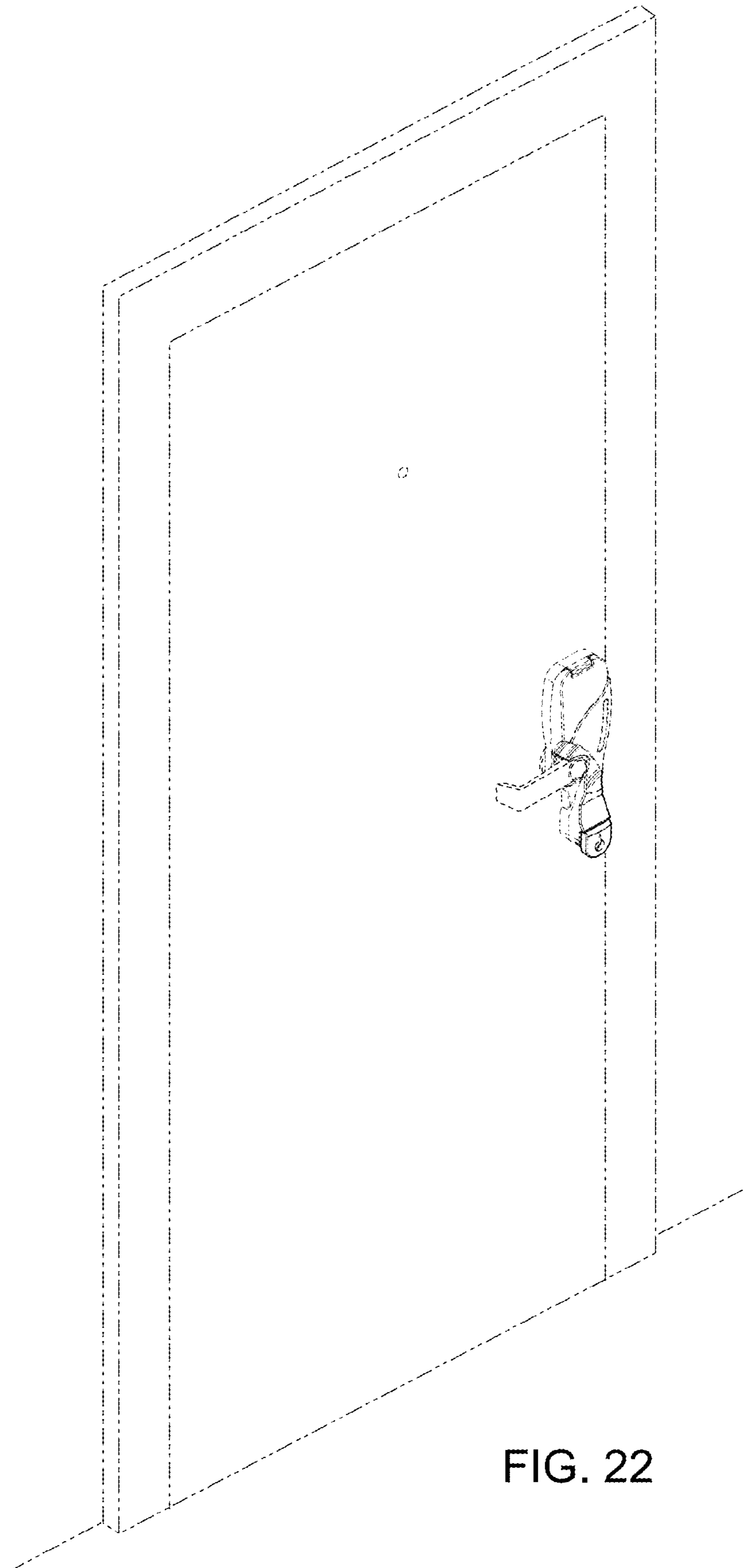

FIG. 22