



US00D916477S

(12) **United States Design Patent** (10) **Patent No.:** **US D916,477 S**
Tu (45) **Date of Patent:** **** Apr. 20, 2021**

(54) **OFFICE CHAIR**
(71) Applicant: **Fang Tu**, Zhejiang (CN)
(72) Inventor: **Fang Tu**, Zhejiang (CN)
(**) Term: **15 Years**
(21) Appl. No.: **29/677,965**
(22) Filed: **Jan. 24, 2019**
(51) **LOC (13) Cl.** **06-01**
(52) **U.S. Cl.**
USPC **D6/366**
(58) **Field of Classification Search**
USPC D6/334-336, 364, 365, 366, 367, 374,
D6/379, 716, 716.1, 716.2, 716.3, 716.4,
D6/716.5
CPC A47C 7/004; A47C 7/006; A47C 7/18;
A47C 7/24; A47C 7/282; A47C 7/285;
A47C 7/36; A47C 7/38; A47C 7/386;
A47C 7/40; A47C 7/46; A47C 7/462;
A47C 7/54; A47C 7/541
See application file for complete search history.

D451,723 S * 12/2001 Grove D6/366
D456,160 S * 4/2002 Van De Riet D6/366
D488,314 S * 4/2004 Chou D6/366
D493,627 S * 8/2004 Ma D6/366
D557,913 S * 12/2007 Ong D6/366
D571,570 S * 6/2008 Zhang D6/366
D597,772 S * 8/2009 True D6/366
D661,136 S * 6/2012 Su D6/716.4
D766,605 S * 9/2016 Li D6/366
D775,480 S * 1/2017 Wagner D6/366
D785,390 S * 5/2017 Tong D6/716
D816,362 S * 5/2018 Su D6/366
D823,015 S * 7/2018 Li D6/366
D823,016 S * 7/2018 Li D6/366
D880,885 S * 4/2020 Li D6/366

* cited by examiner

Primary Examiner — Mimoso De

(57) **CLAIM**

I claim the ornamental design for the office chair, as shown and described.

DESCRIPTION

FIG. 1 is a perspective view of an office chair showing my new design;
FIG. 2 is a front elevational view thereof;
FIG. 3 is a rear elevational view thereof;
FIG. 4 is a left side elevational view thereof;
FIG. 5 is a right side elevational view thereof;
FIG. 6 is a top plan view thereof; and,
FIG. 7 is a bottom plan view thereof.
The broken lines shown in the drawings depict portions of the office chair that form no part of the claimed design.

1 Claim, 7 Drawing Sheets

(56) **References Cited**
U.S. PATENT DOCUMENTS

D346,279 S * 4/1994 Stumpf D6/366
D350,033 S * 8/1994 Beaulieu D6/366
D396,155 S * 7/1998 Shamir D6/366
D405,969 S * 2/1999 Beaulieu D6/366
D408,161 S * 4/1999 Caruso D6/366
D431,400 S * 10/2000 Grove D6/716
D439,449 S * 3/2001 Klinkhammer D6/366
D449,172 S * 10/2001 Van De Riet D6/366

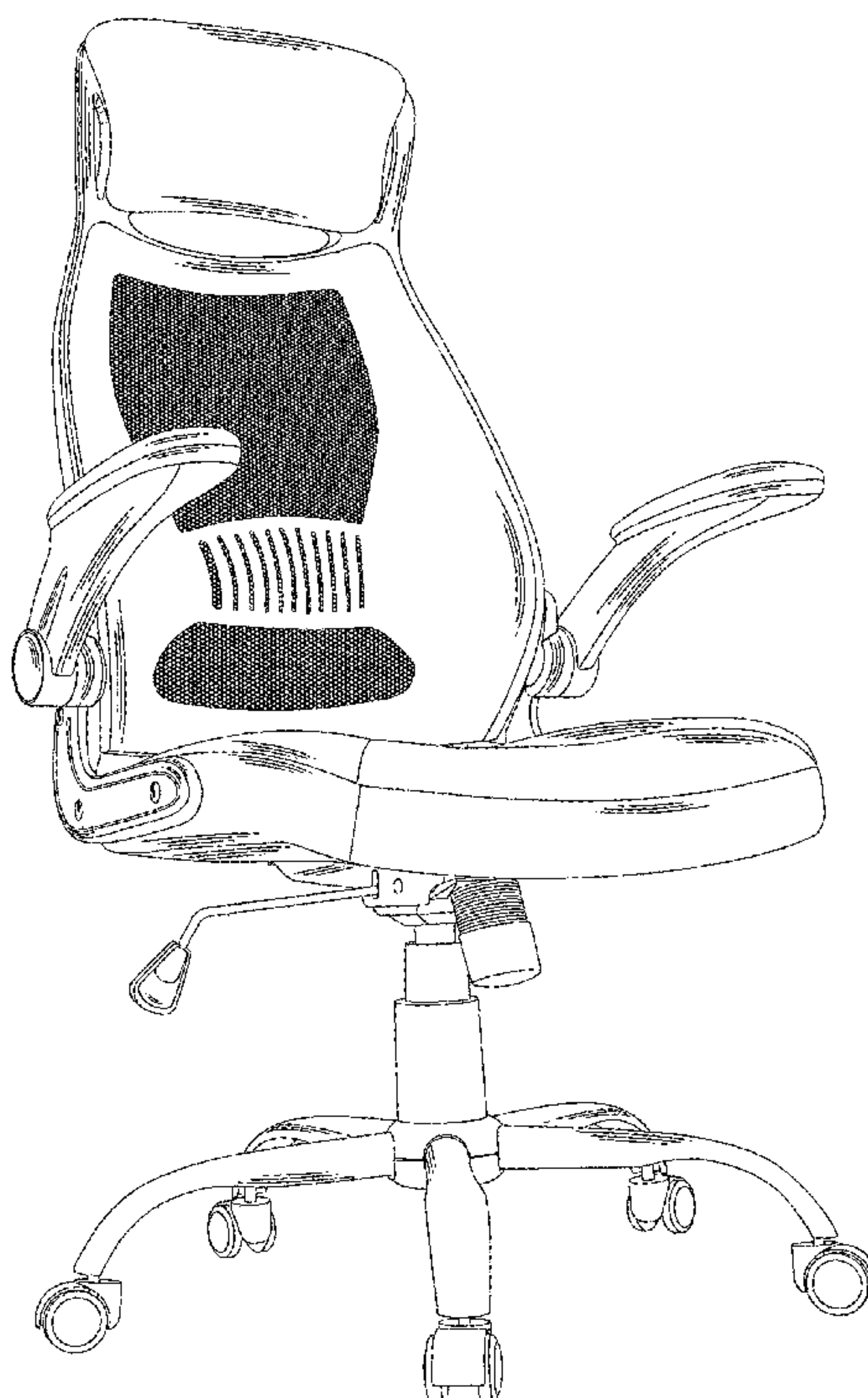

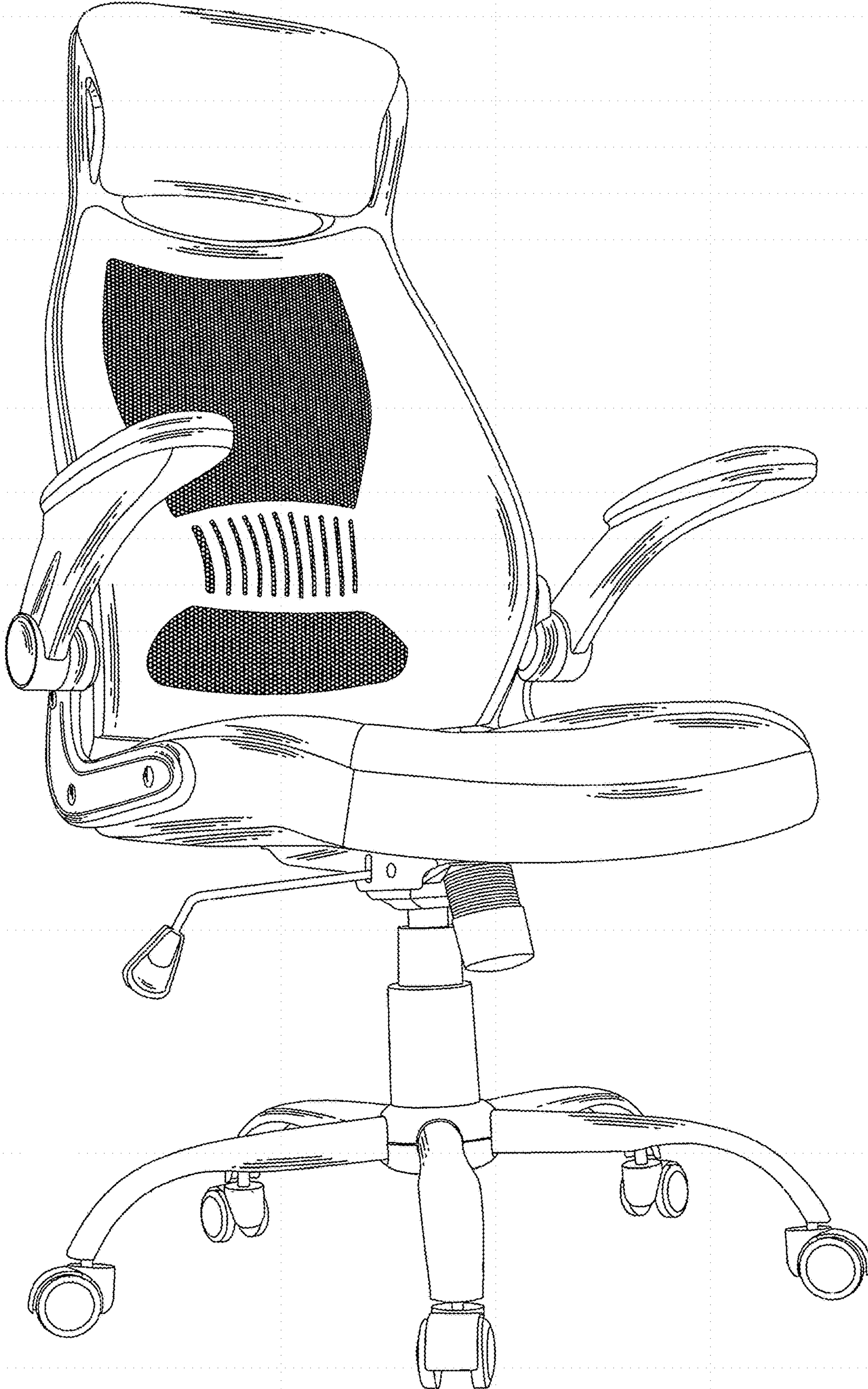

FIG. 1

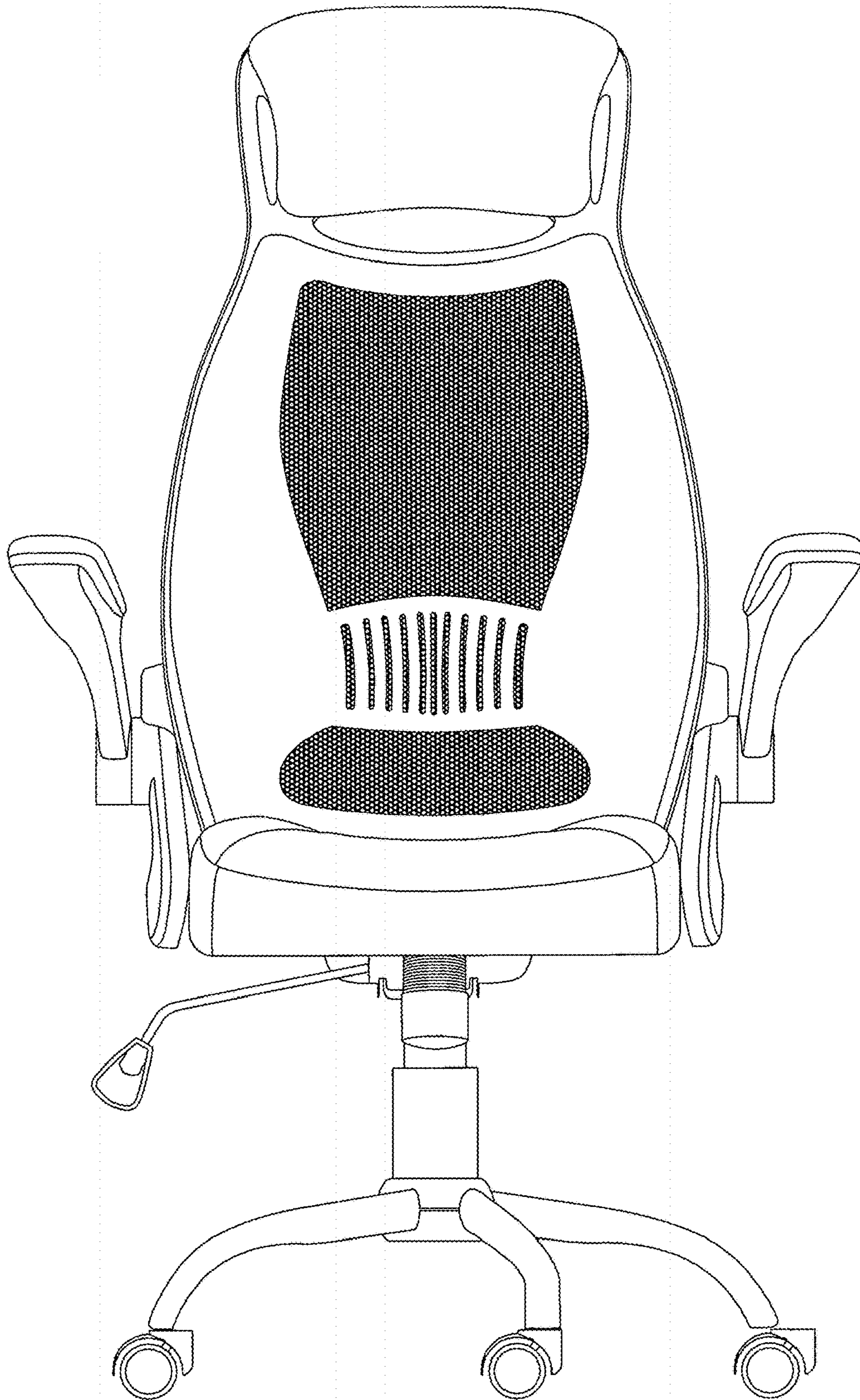

FIG. 2

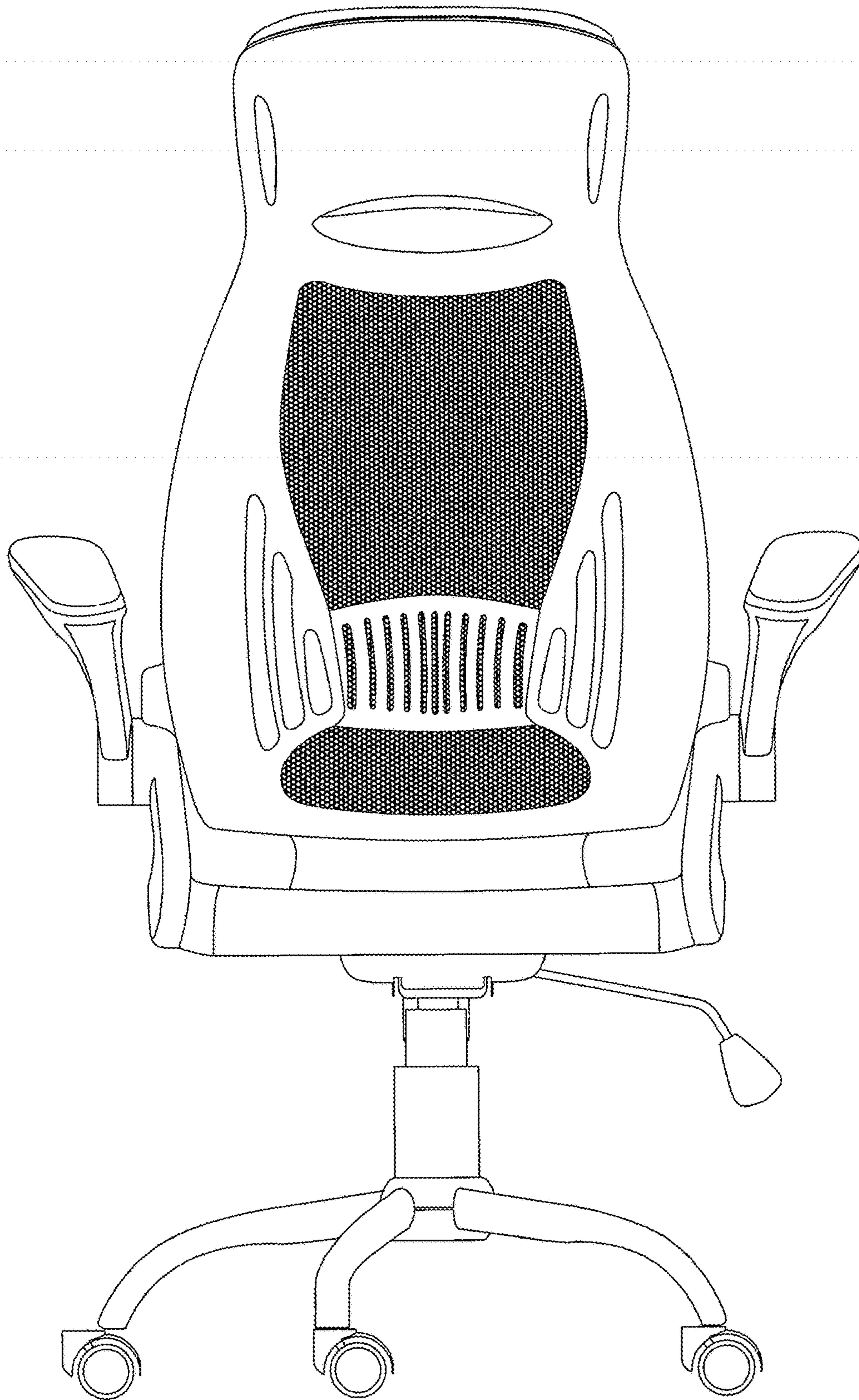

FIG. 3



FIG. 4

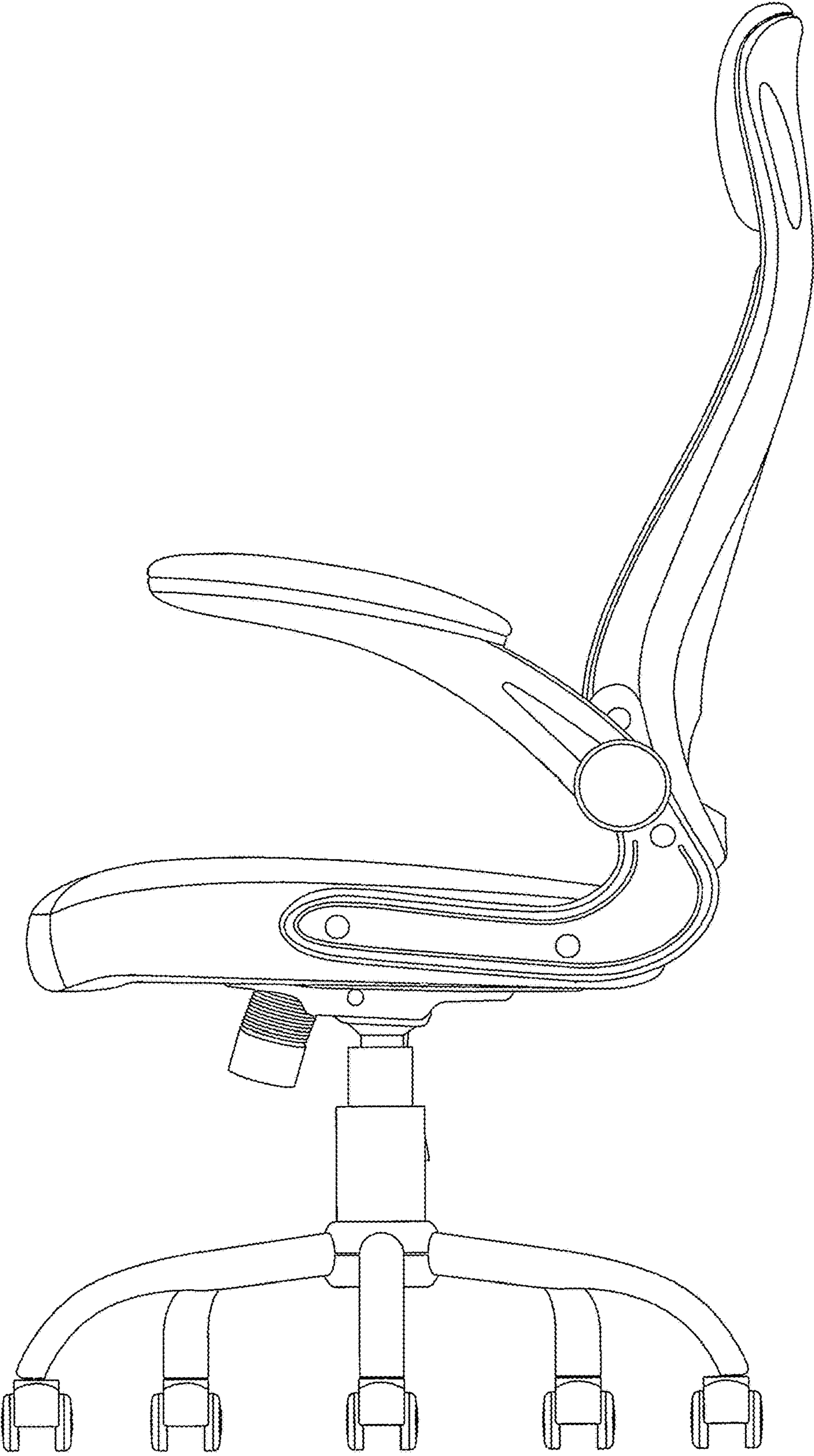

FIG. 5

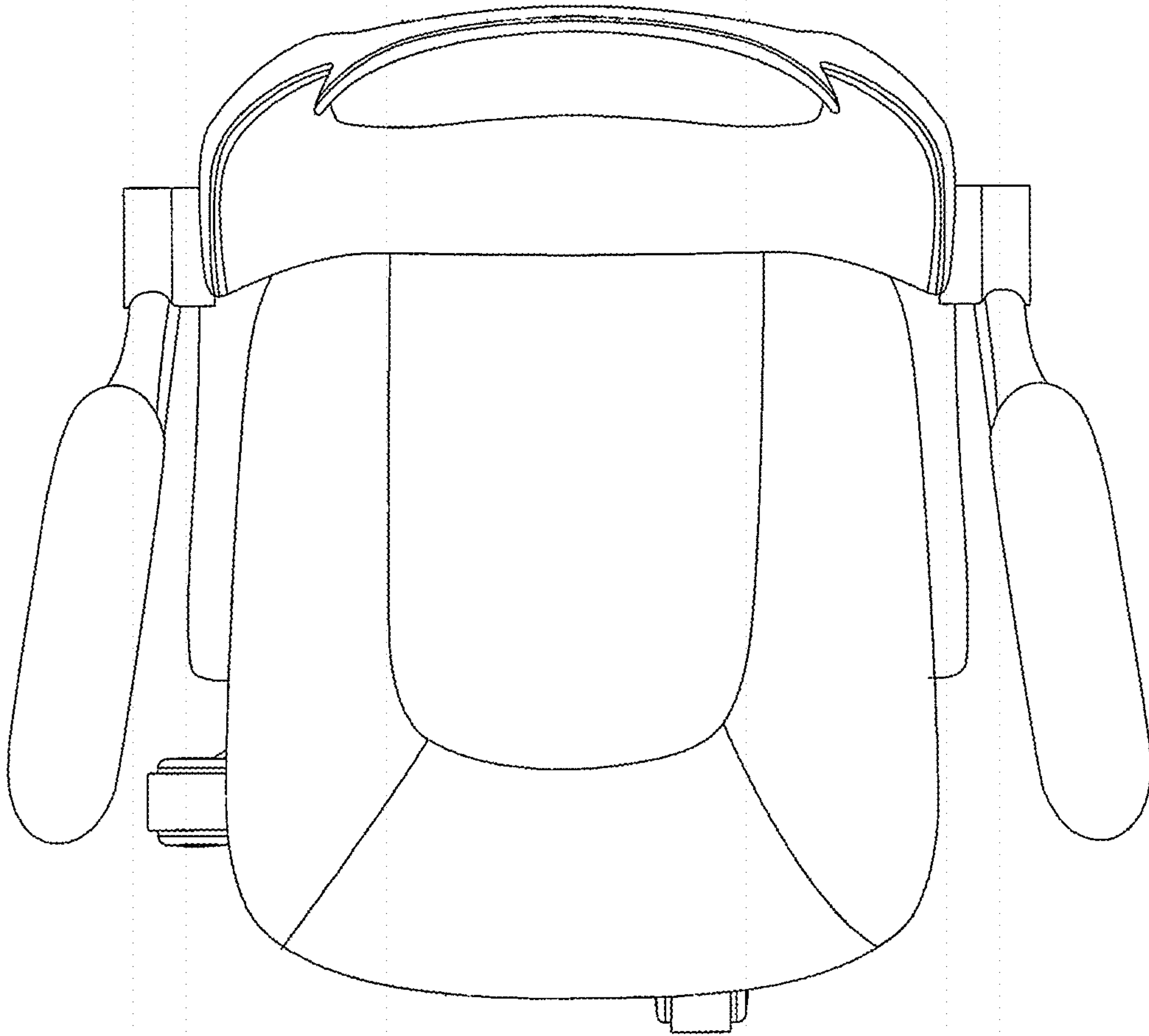

FIG. 6

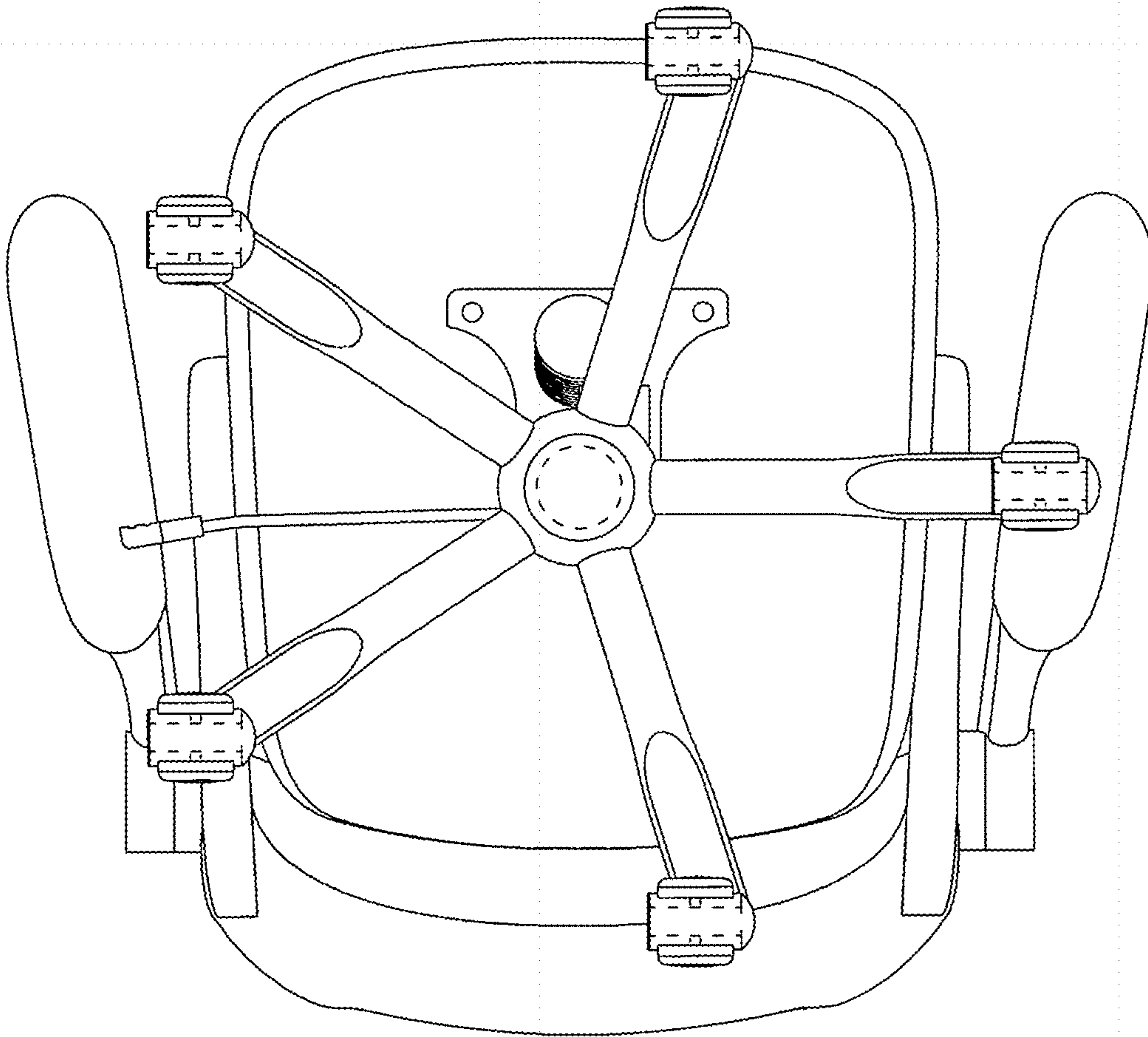

FIG. 7