



US00D916380S

(12) **United States Design Patent** (10) **Patent No.:** **US D916,380 S**
Lee (45) **Date of Patent:** **** Apr. 13, 2021**

(54) **HELMET**
(71) Applicant: **HJC CORP.**, Yongin-si (KR)
(72) Inventor: **Junyoung Lee**, Seoul (KR)
(73) Assignee: **HJC CORP.**, Yongin-si (KR)
(**) Term: **15 Years**
(21) Appl. No.: **29/705,115**
(22) Filed: **Sep. 10, 2019**
(51) **LOC (13) Cl.** **02-03**
(52) **U.S. Cl.**
USPC **D29/107**
(58) **Field of Classification Search**
USPC D29/102, 103, 104, 105, 106, 107, 108,
D29/109, 110, 112, 122

CPC .. A42B 3/00; A42B 3/04; A42B 3/066; A42B
3/10; A42B 3/166; A42B 3/22; A42B
3/221; A42B 3/225; A42B 3/226; A42B
3/227; A42B 3/228; A42B 3/28; A42B
3/285
See application file for complete search history.

(56) **References Cited**
U.S. PATENT DOCUMENTS
D601,307 S * 9/2009 Izquierdo Mediavilla .. D29/107
D673,734 S * 1/2013 Hwang D29/107
D696,464 S * 12/2013 Hwang D29/107
D739,609 S * 9/2015 Kimura D29/107
D751,767 S * 3/2016 Shida D29/107
D819,892 S * 6/2018 Lee D29/107
D822,907 S * 7/2018 Fukuyama D29/107
D836,254 S * 12/2018 Nimura D29/107
D838,917 S * 1/2019 Murakami D29/107
D843,663 S * 3/2019 Locatelli D29/107
D849,328 S * 5/2019 Tang D29/107

D853,042 S * 7/2019 Lee D29/107
D859,748 S * 9/2019 Lee D29/107

* cited by examiner

Primary Examiner — Jasmine Mlinarcik
(74) *Attorney, Agent, or Firm* — NSIP Law

(57) **CLAIM**

I claim the ornamental design for a helmet, as shown and described.

DESCRIPTION

FIG. 1 is a front view of a helmet showing my new design; FIG. 2 is a rear view thereof; FIG. 3 is a left-side view thereof; FIG. 4 is a right-side view thereof; FIG. 5 is a top view thereof; FIG. 6 is a bottom view thereof; FIG. 7 is a front perspective view thereof; FIG. 8 is an enlargement of the encircled portion 8 in FIG. 1; FIG. 9 is an enlargement of the encircled portion 9 in FIG. 1; FIG. 10 is an enlargement of the encircled portion 10 in FIG. 1; FIG. 11 is an enlargement of the encircled portion 11 in FIG. 2; FIG. 12 is an enlargement of the encircled portion 12 in FIG. 3; FIG. 13 is an enlargement of the encircled portion 13 in FIG. 3; FIG. 14 is an enlargement of the encircled portion 14 in FIG. 6; and, FIG. 15 is an enlargement of the encircled portion 15 in FIG. 7.

The broken lines in the figures depict portions of the helmet which form no part of the claimed design. The dot-dot-dash broken lines encircling portions of the claimed design that are shown in enlargements form no part of the claimed design.

1 Claim, 15 Drawing Sheets

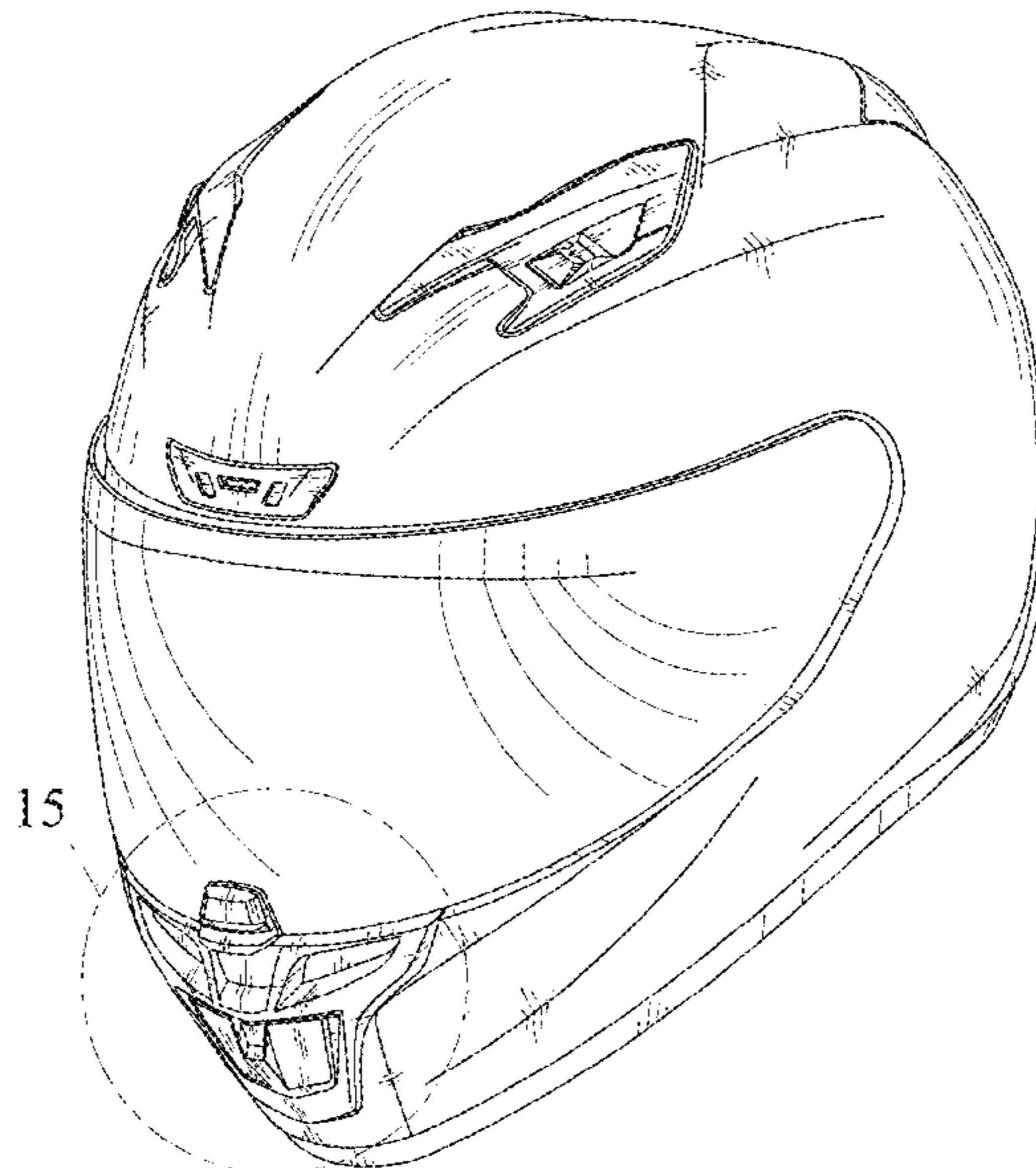

FIG. 1

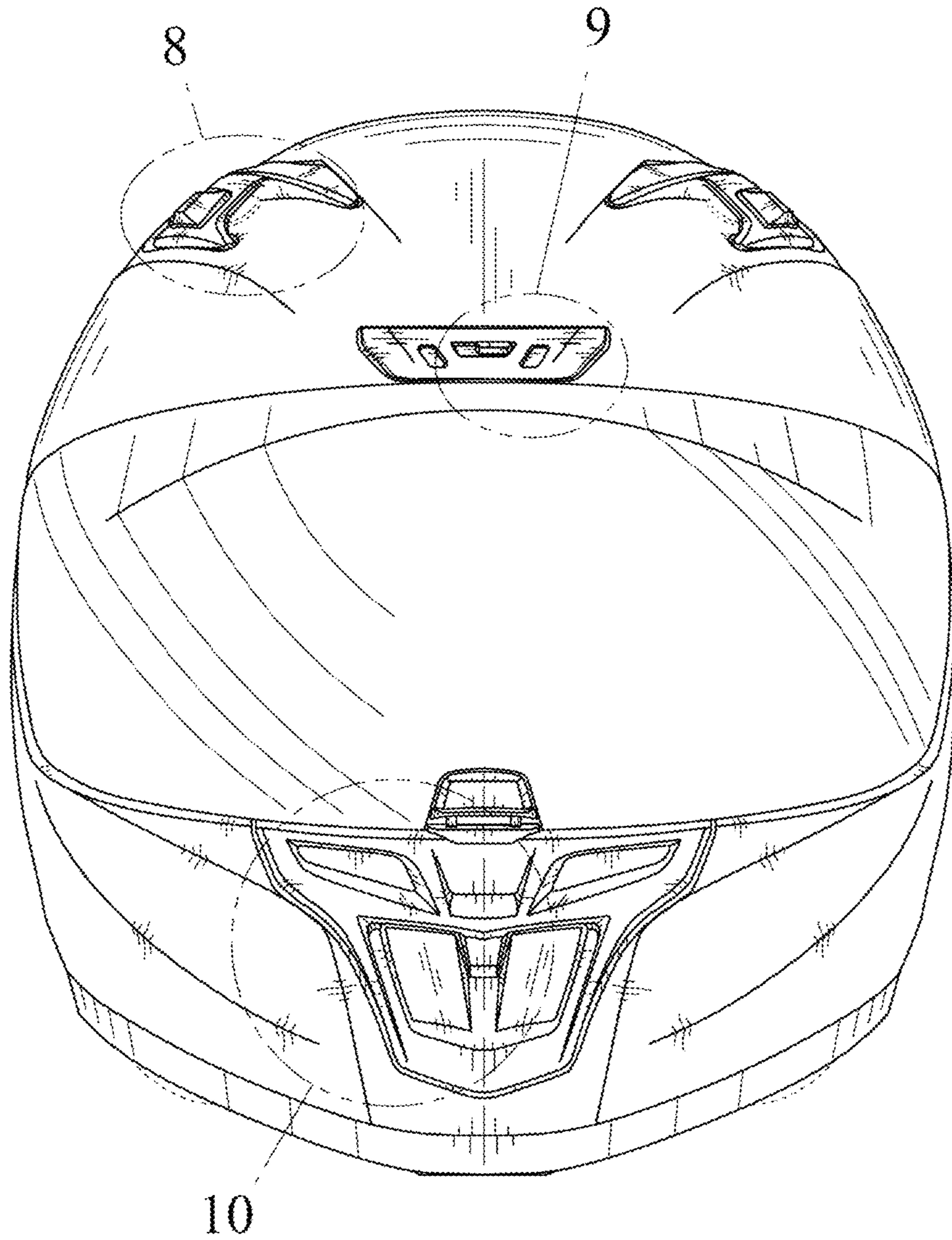

FIG. 2

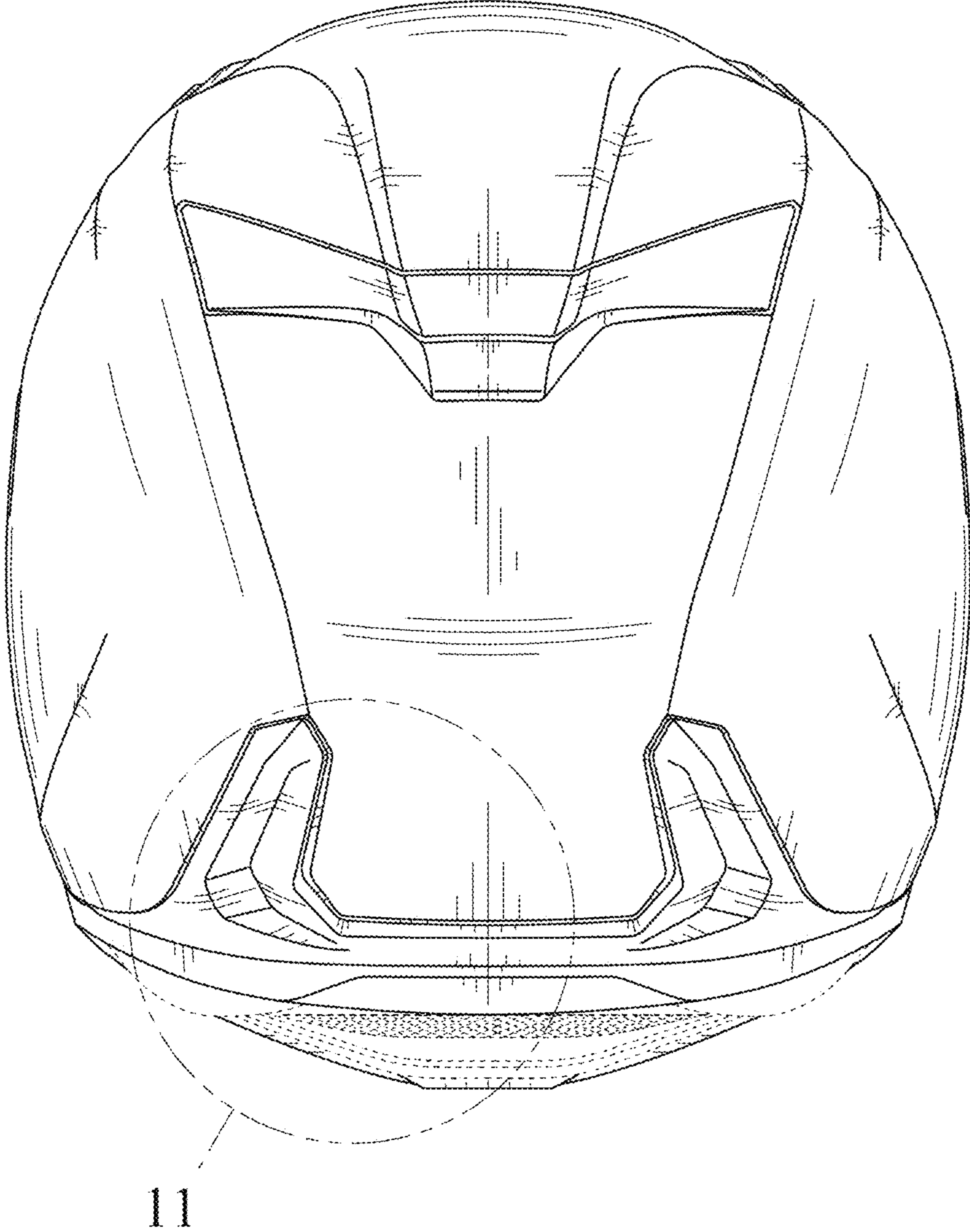

FIG. 3

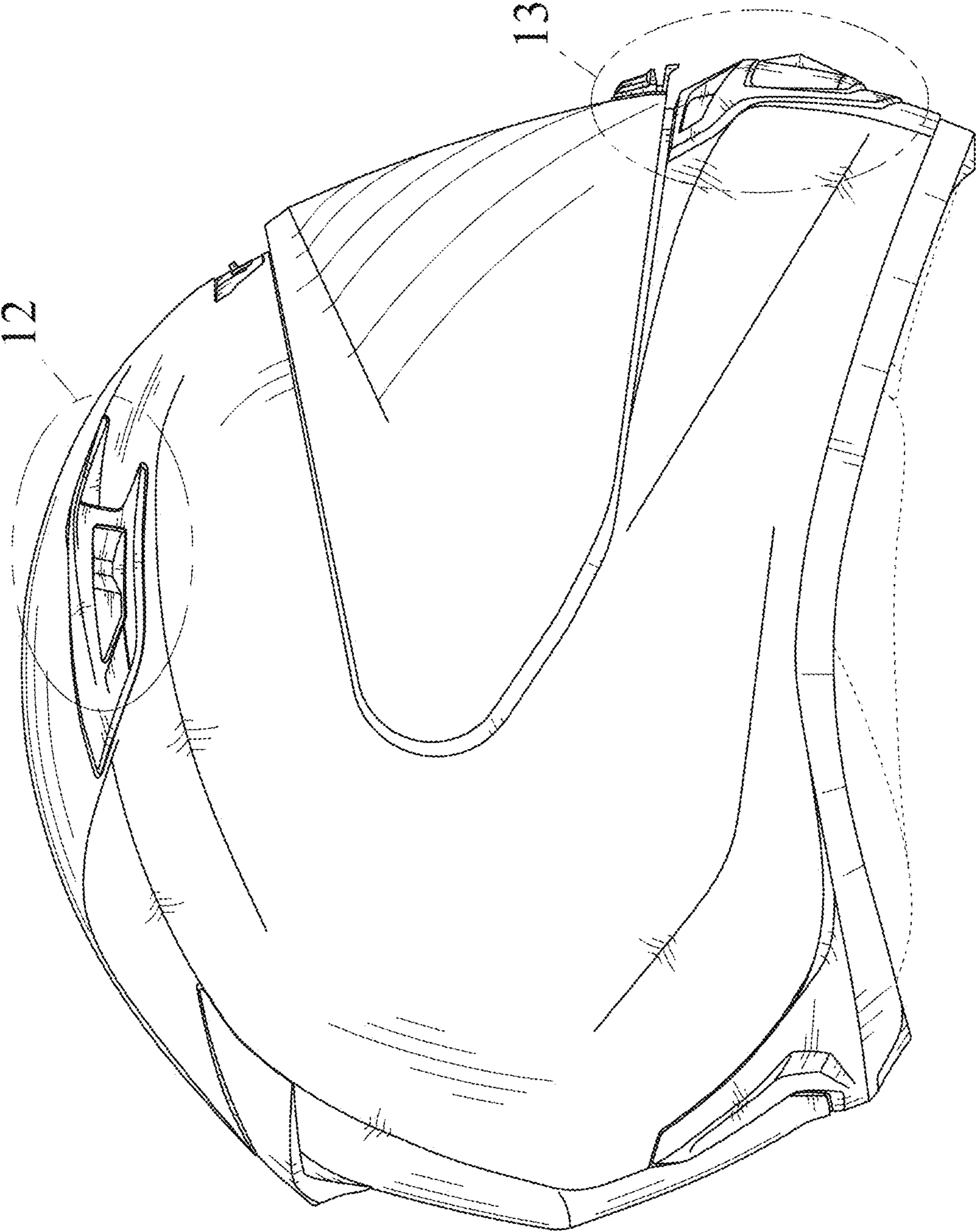

FIG. 4

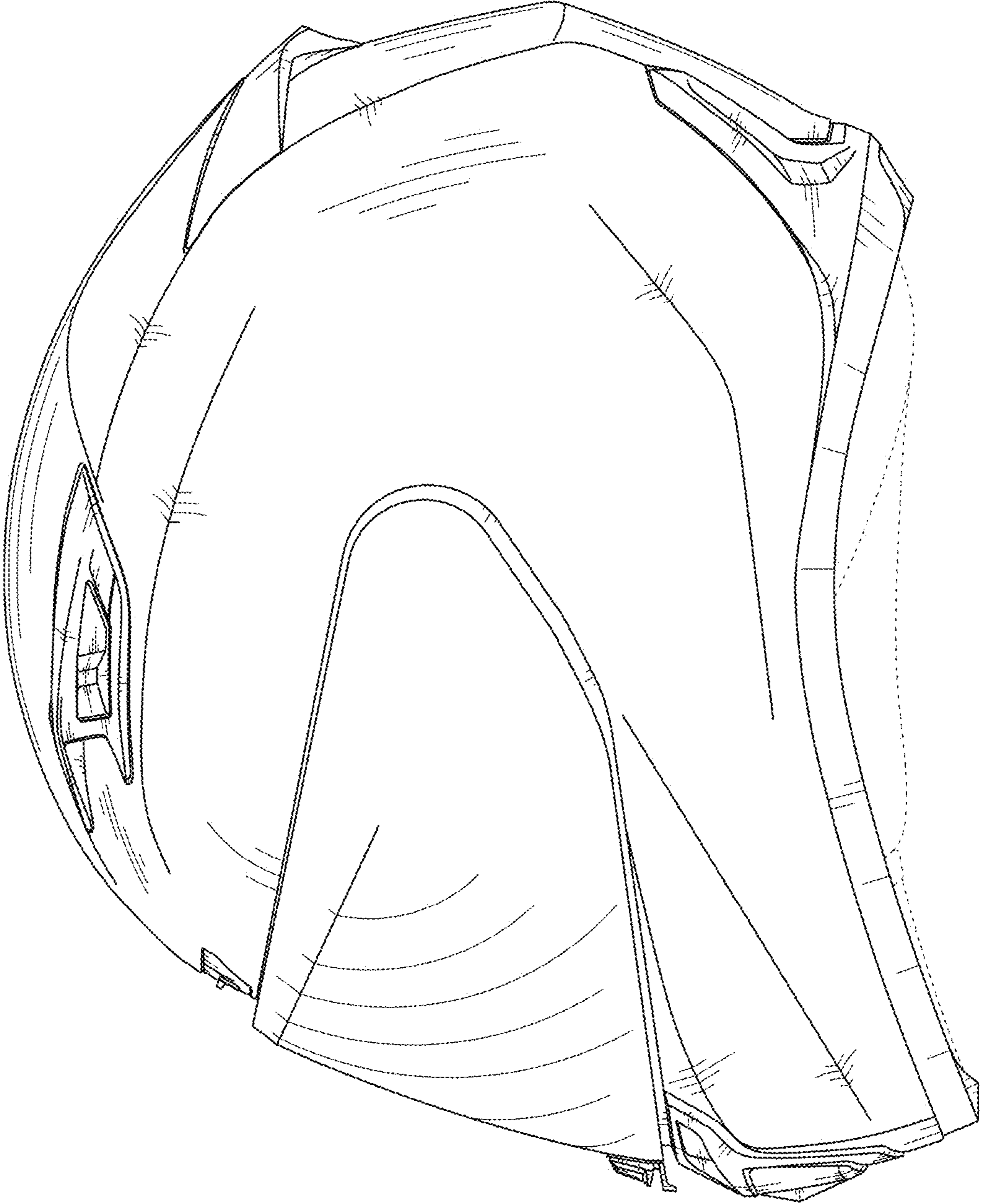

FIG. 5

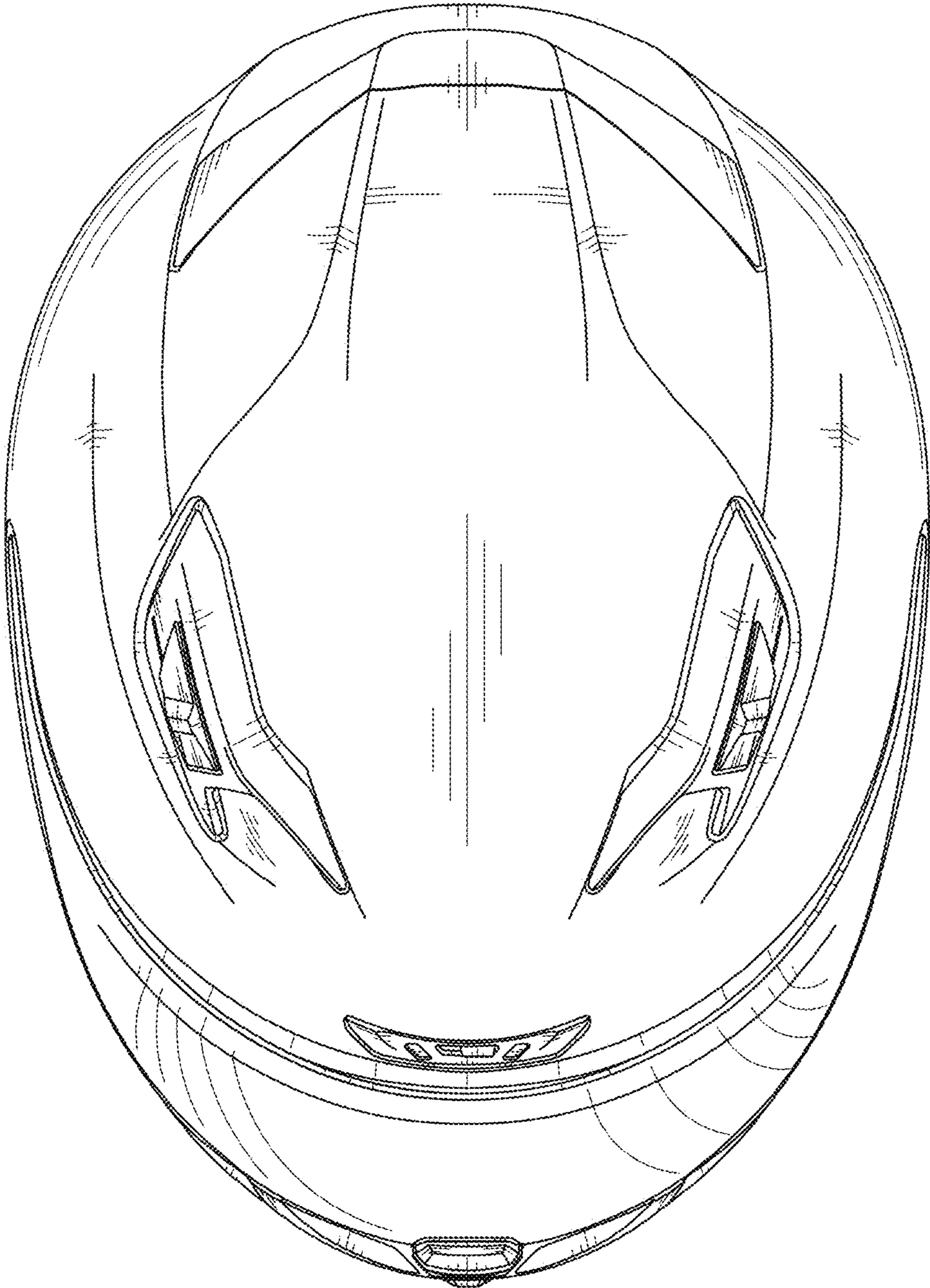

FIG. 6

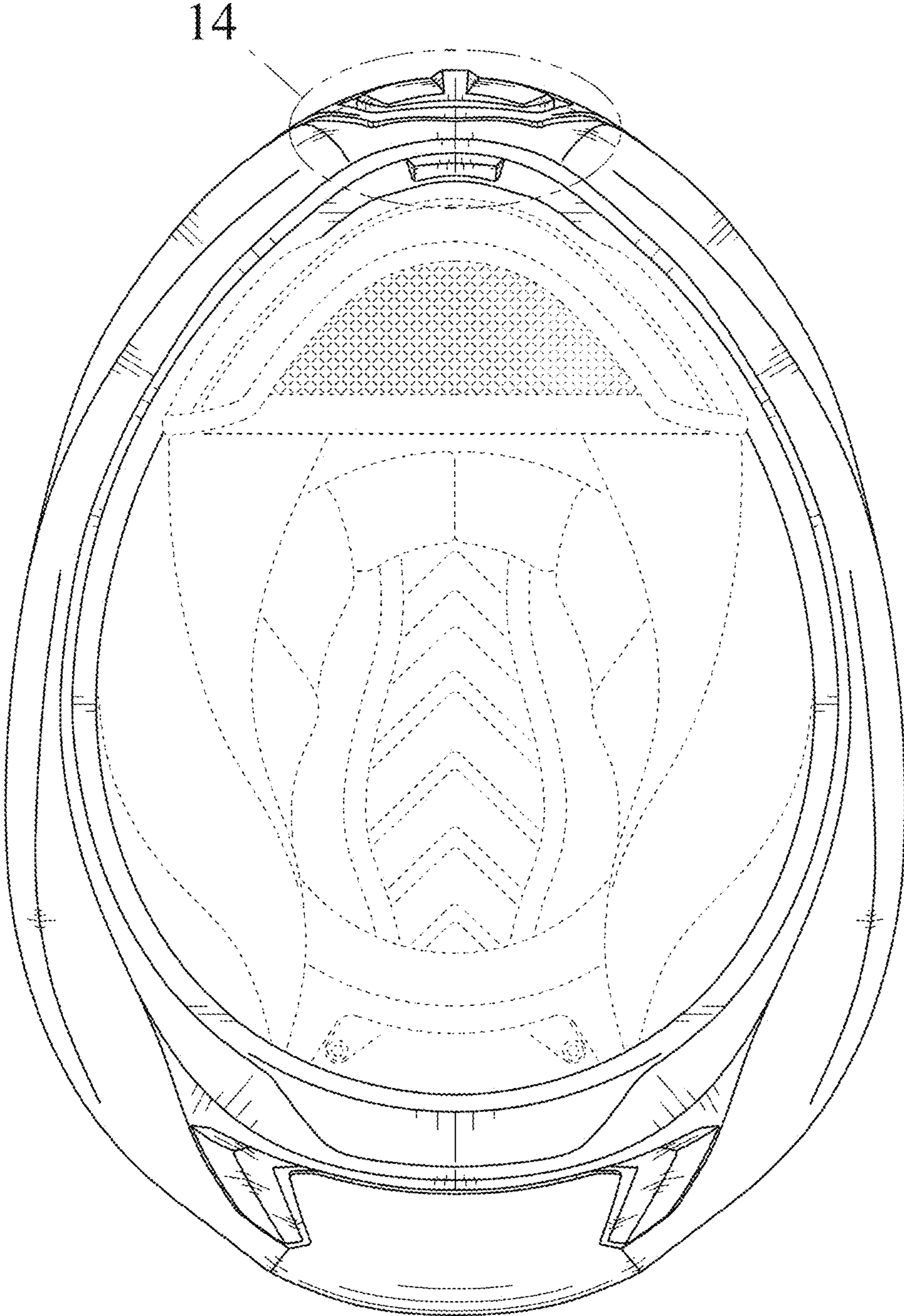

FIG. 7

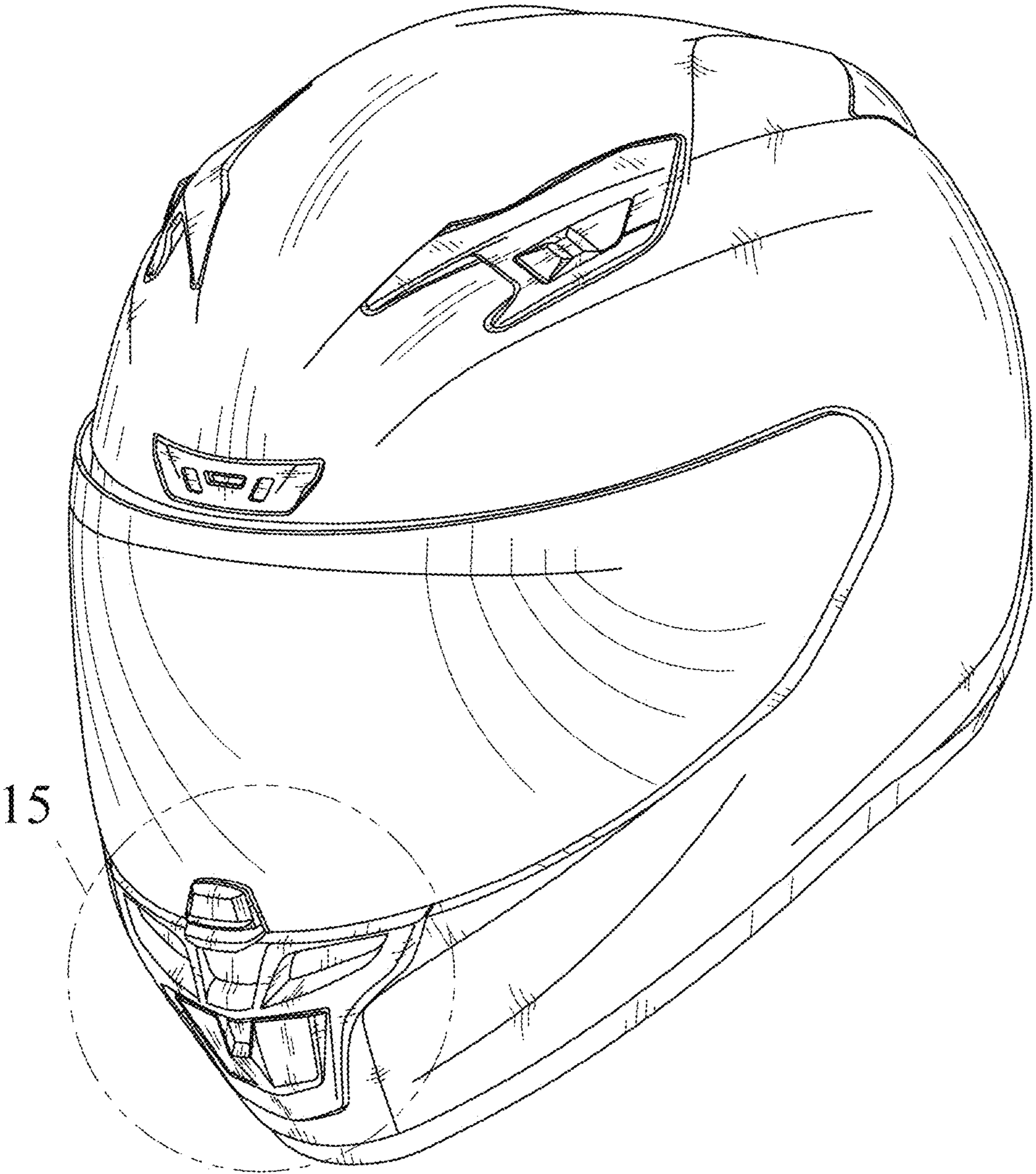

FIG. 8

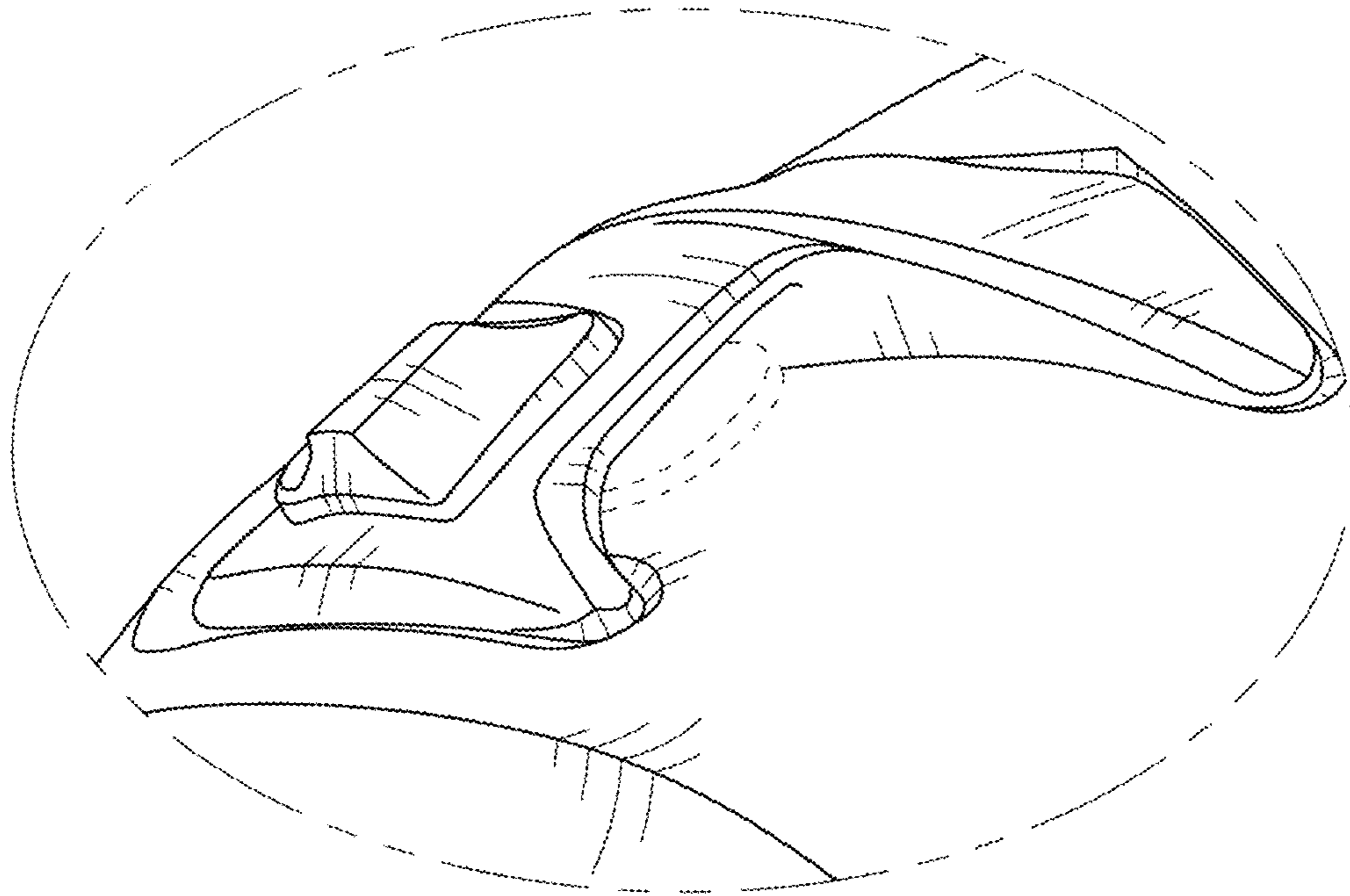

FIG. 9

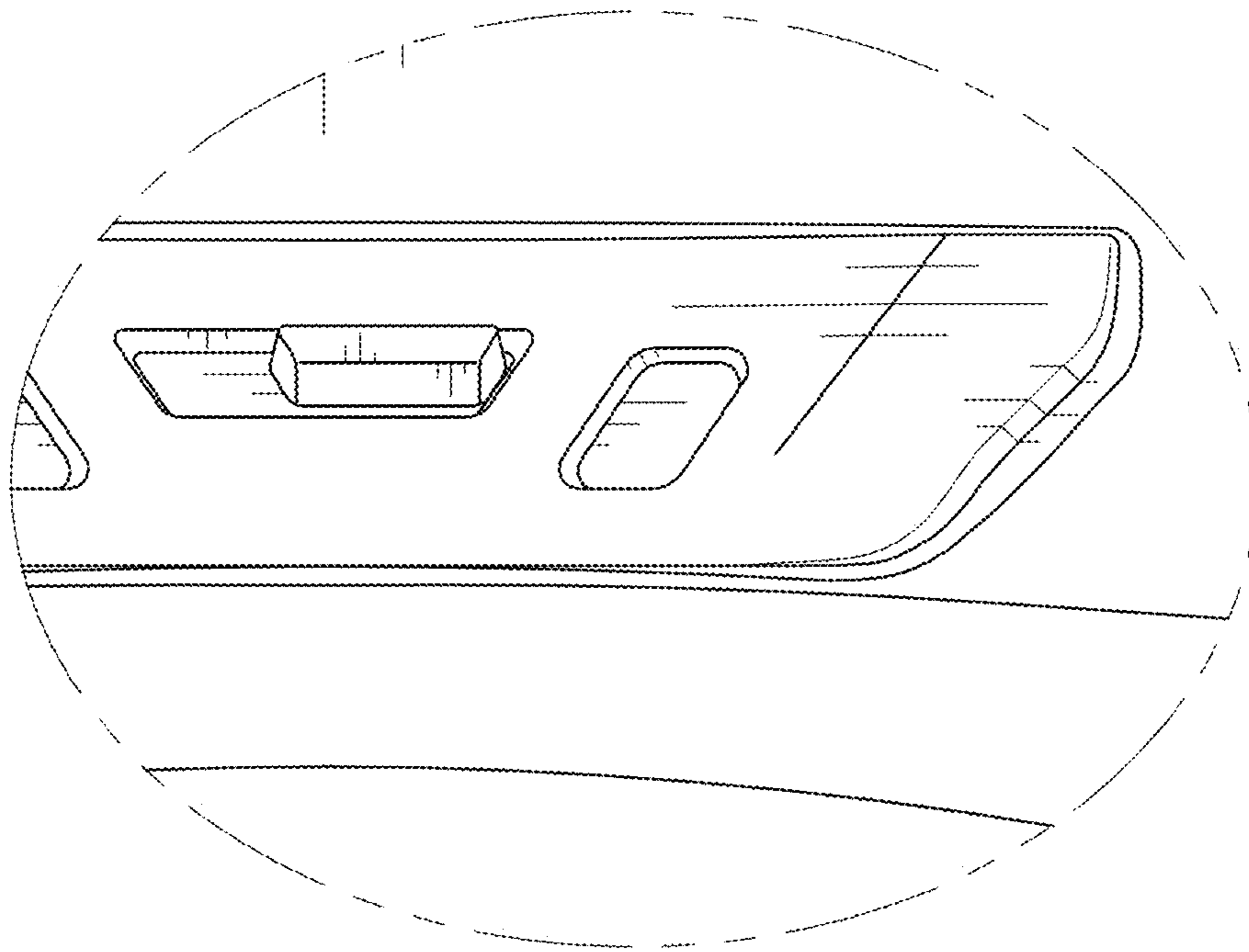

FIG. 10

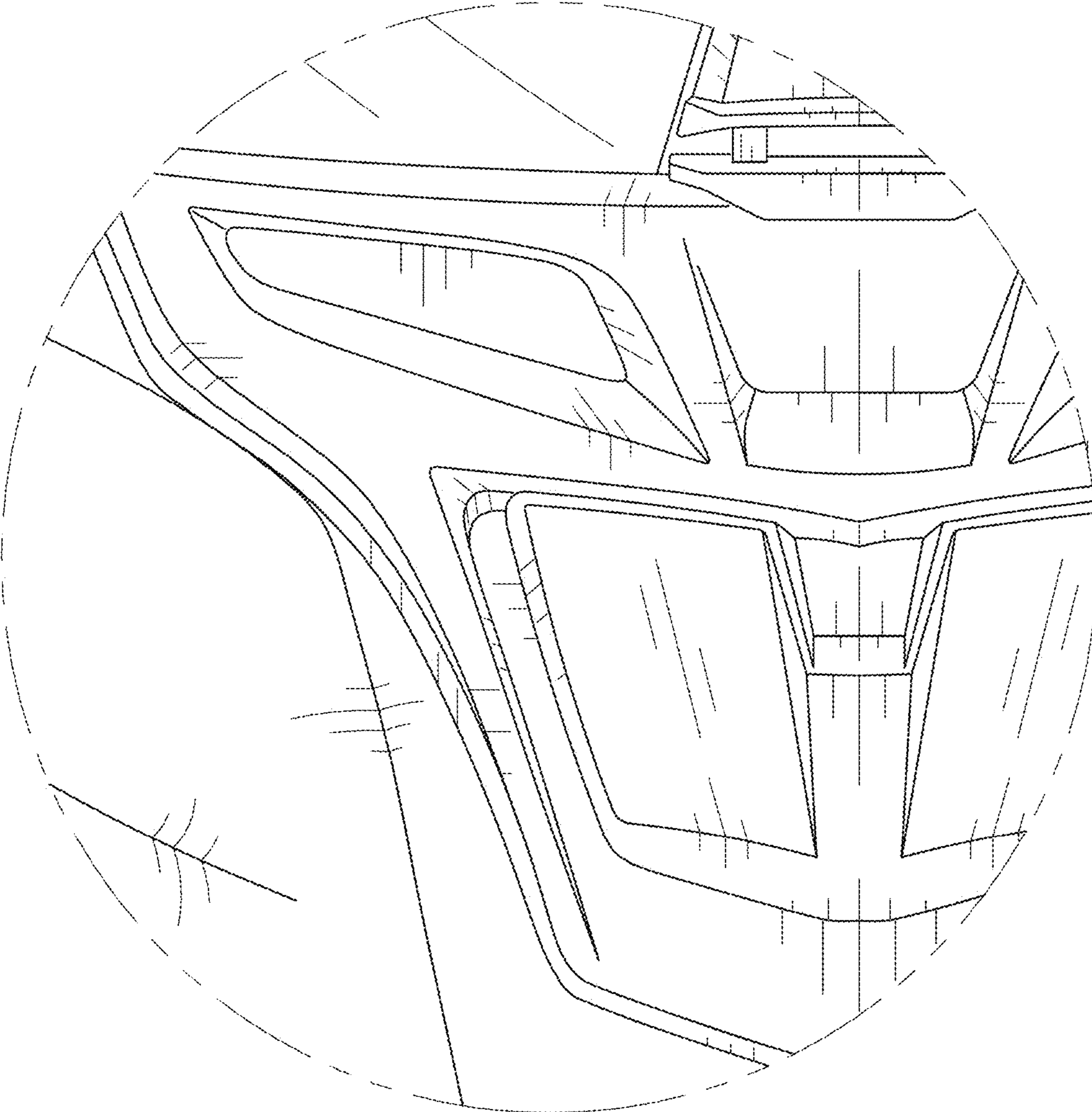

FIG. 11

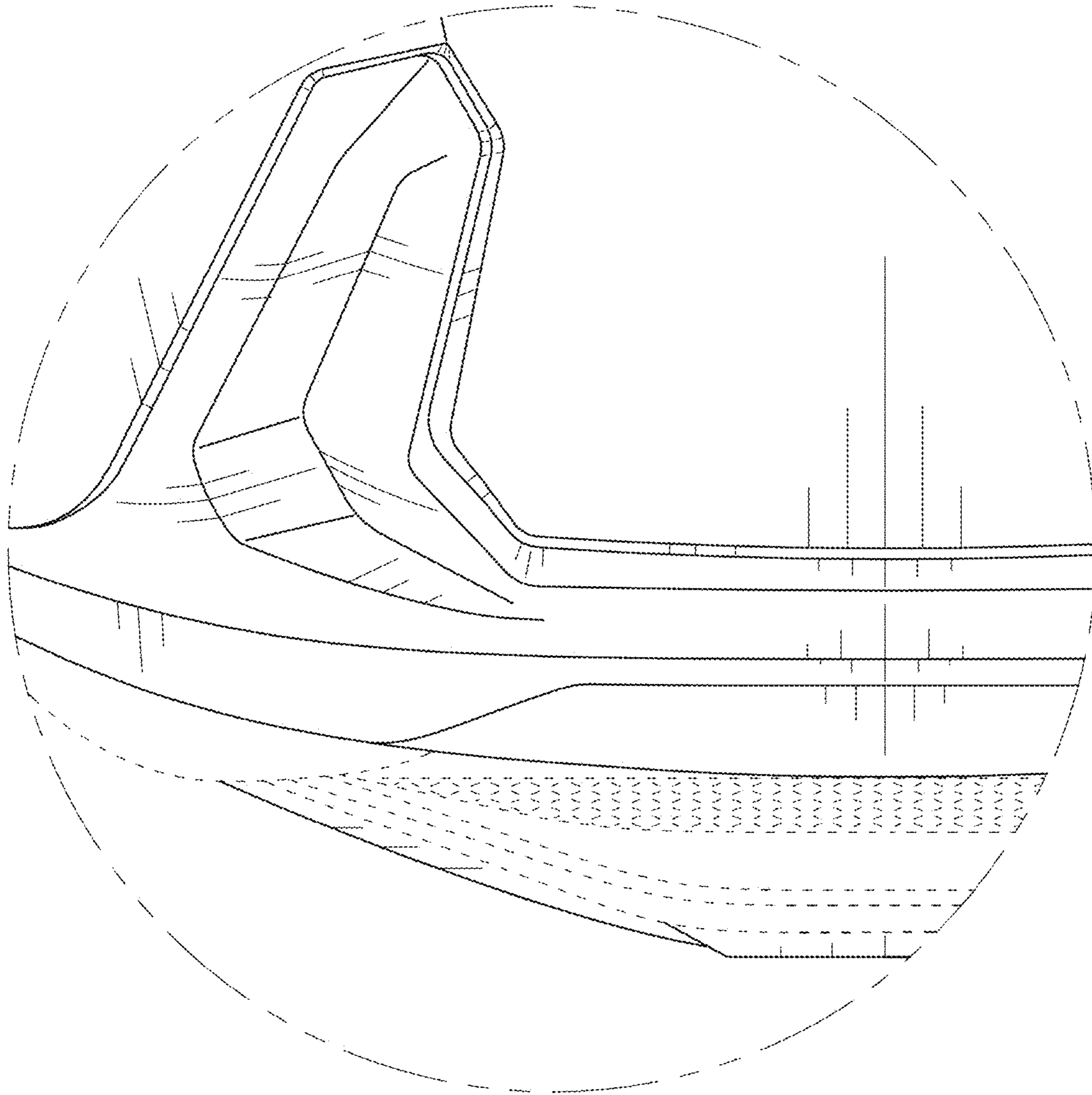

FIG. 12

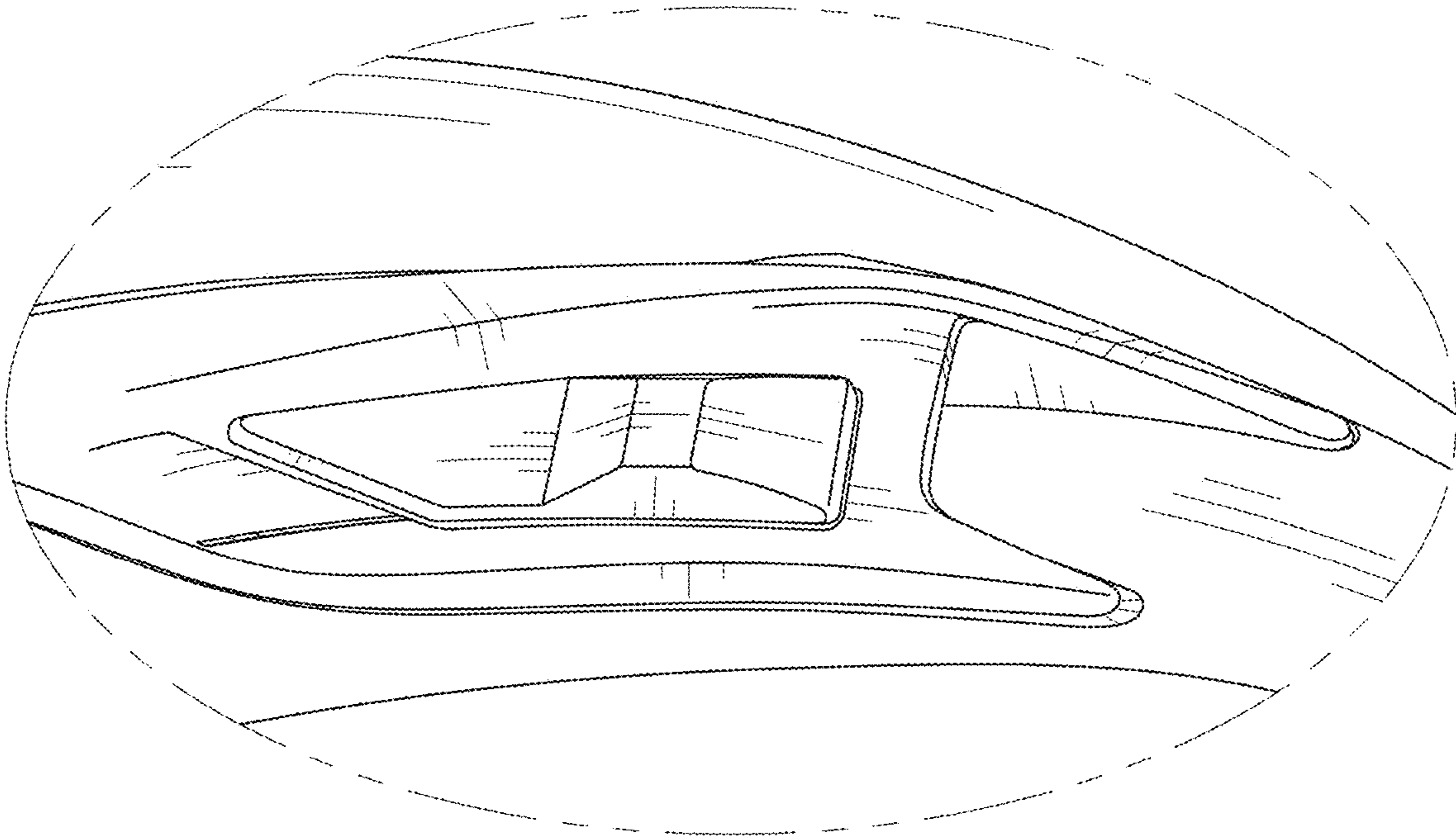

FIG. 13

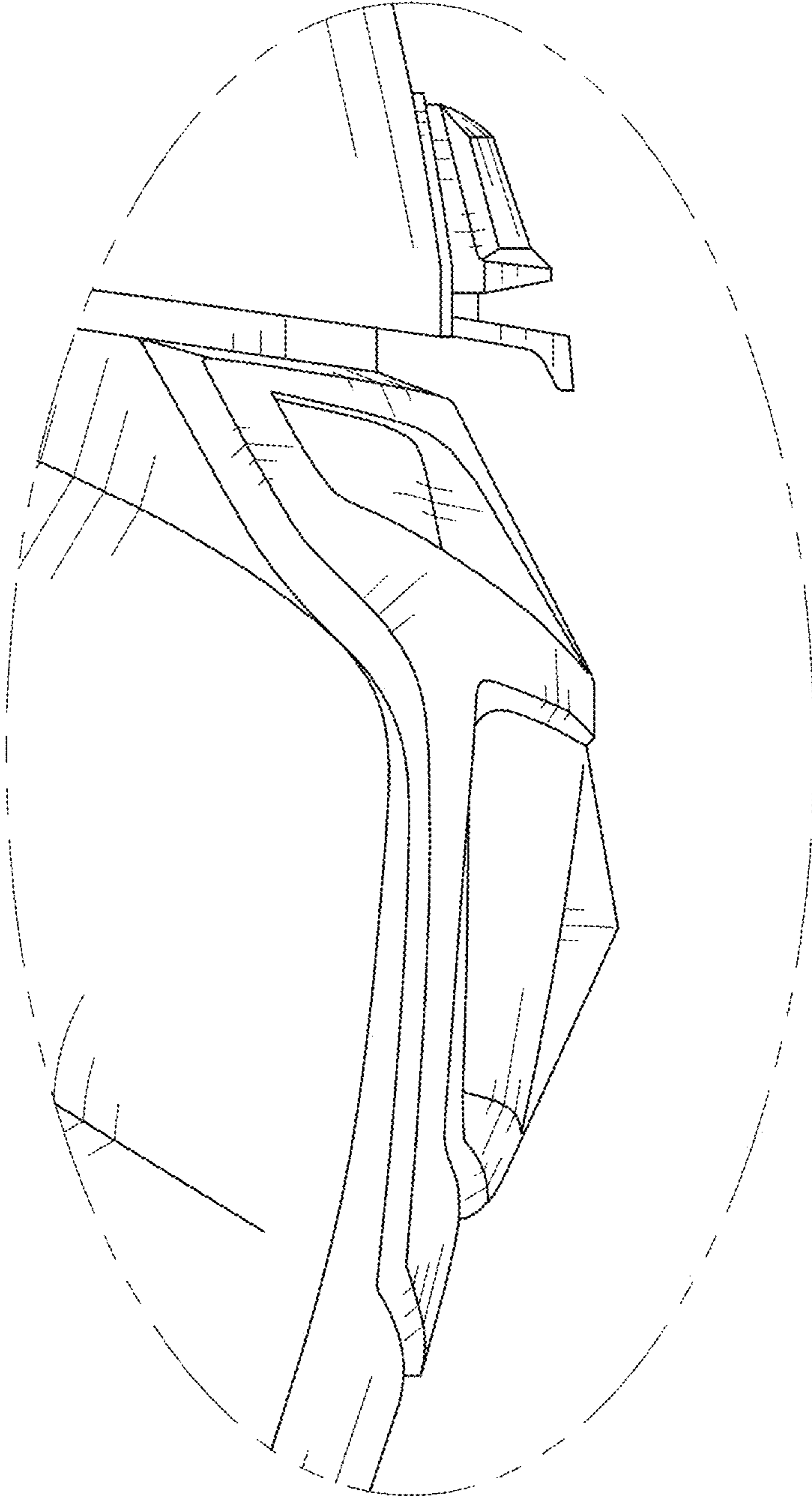

FIG. 14

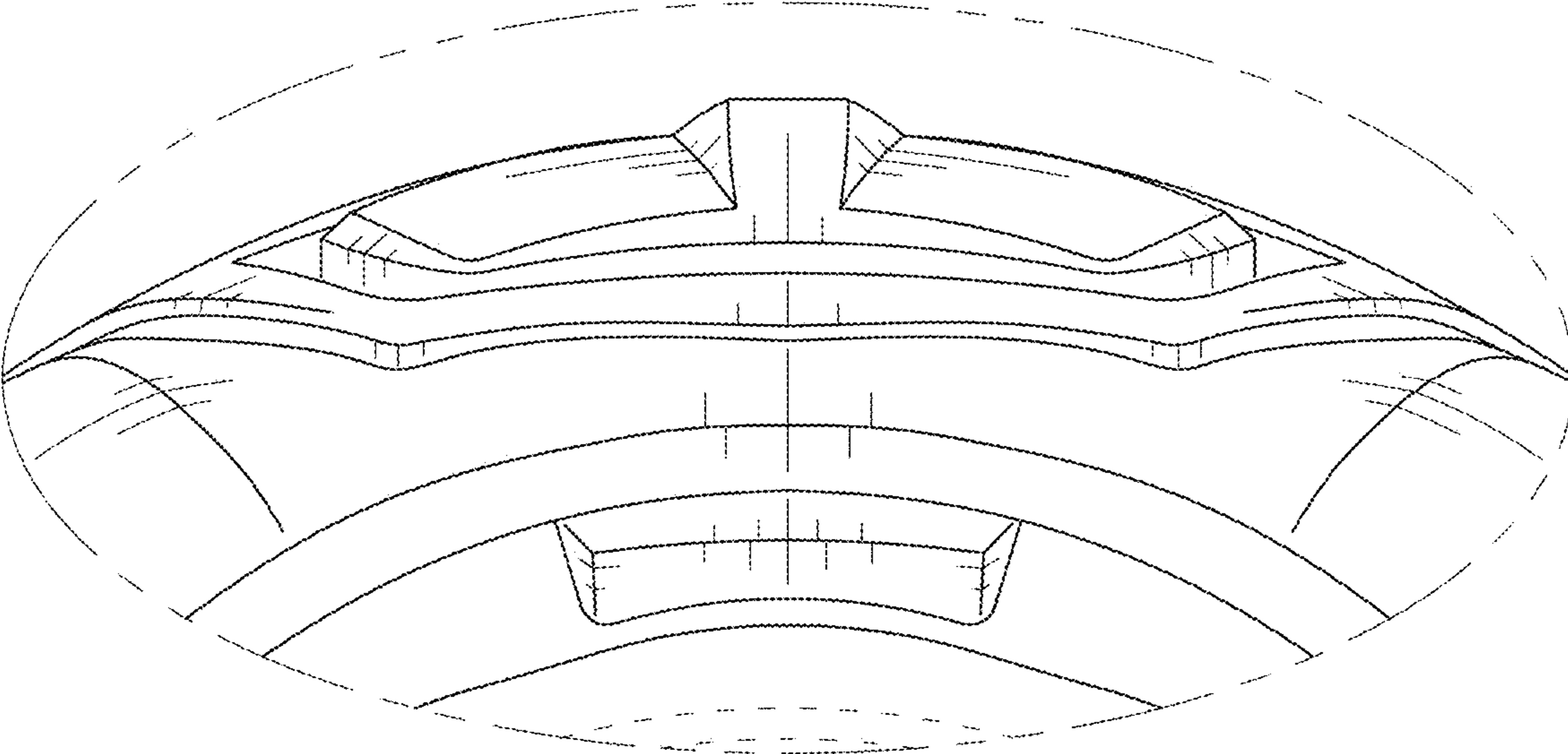

FIG. 15

