



US00D916306S

(12) **United States Design Patent** (10) **Patent No.:** **US D916,306 S**
Du (45) **Date of Patent:** **** Apr. 13, 2021**

(54) **BEAUTY INSTRUMENT**
(71) Applicant: **Comper Chuangxiang (Beijing) Technology Co., Ltd., Beijing (CN)**
(72) Inventor: **Han Du, Beijing (CN)**
(73) Assignee: **COMPER CHUANGXIANG (BEIJING) TECHNOLOGY CO., LTD., Beijing (CN)**
(**) Term: **15 Years**
(21) Appl. No.: **29/713,591**
(22) Filed: **Nov. 18, 2019**

D366,703 S * 1/1996 Huen D13/108
D377,394 S * 1/1997 Tillman D24/215
D403,075 S * 12/1998 Lie D24/214
D415,283 S * 10/1999 Moon D24/214
D447,811 S * 9/2001 Yiu D24/214
6,572,637 B1 * 6/2003 Yamazaki A61B 18/203
607/89
D533,943 S * 12/2006 Chen D24/146
D561,343 S * 2/2008 Liang D24/215
D569,523 S * 5/2008 Hsieh D24/206
D629,118 S * 12/2010 Yeo D24/214
D649,657 S * 11/2011 Petersen D24/215
D652,523 S * 1/2012 Bradley D24/209
D671,226 S * 11/2012 Aulwes D24/215
D759,256 S * 6/2016 Chen D24/200
D759,261 S * 6/2016 Son D24/215
D759,831 S * 6/2016 Levi D24/200

(Continued)

(30) **Foreign Application Priority Data**
May 21, 2019 (CN) 201930251048.3
(51) **LOC (13) Cl.** **28-03**
(52) **U.S. Cl.**
USPC **D24/214**
(58) **Field of Classification Search**
USPC D24/200, 214, 215; D28/52
CPC A61H 2201/10; A61H 15/00; A61H
15/0085; A61N 2007/0034; A61N 5/0616;
A61B 2018/00452
See application file for complete search history.

Primary Examiner — Cynthia Ramirez
Assistant Examiner — Michael A Maharajh
(74) *Attorney, Agent, or Firm* — Bayramoglu Law Offices LLC

(57) **CLAIM**

The ornamental design for a beauty instrument, as shown and described.

DESCRIPTION

FIG. 1 is a front elevational view of a beauty instrument showing my new design;
FIG. 2 is a rear elevational view thereof;
FIG. 3 is a left side elevational view thereof;
FIG. 4 is a right side elevational view thereof;
FIG. 5 is a top plan view thereof;
FIG. 6 is a bottom plan view thereof;
FIG. 7 is a right perspective view thereof; and,
FIG. 8 is a left perspective view thereof.
The broken lines depict portions of the beauty instrument in which the design is embodied that form no part of the claimed design.

(56) **References Cited**
U.S. PATENT DOCUMENTS
D263,872 S * 4/1982 Rakocy D24/214
D321,056 S * 10/1991 Chambers D24/211
D324,914 S * 3/1992 Bucher D24/206
5,187,827 A * 2/1993 Wei A46B 13/06
15/22.1
D334,430 S * 3/1993 Tsou D24/214
D339,198 S * 9/1993 Mochida D24/211
D355,259 S * 2/1995 Lie D24/215
D359,563 S * 6/1995 Chi D24/214

1 Claim, 8 Drawing Sheets

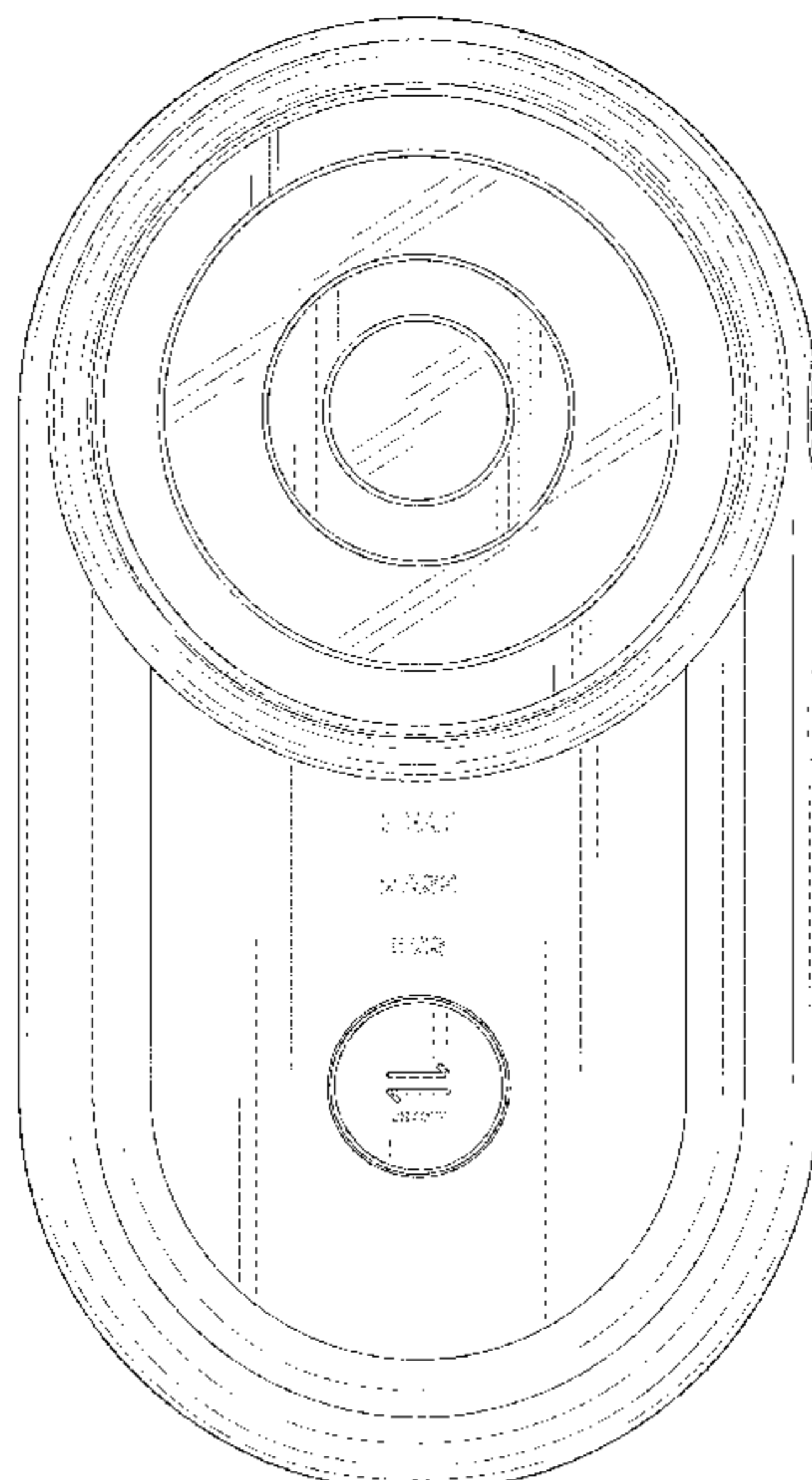

(56)

References Cited

U.S. PATENT DOCUMENTS

| | | | | | | | | | |
|--------------|---------|--------------|-------|---------|-------------------|---------|----------------|-------|------------------------|
| D768,310 S * | 10/2016 | Hetzel | | D24/214 | D897,110 S * | 9/2020 | Blank | | D4/102 |
| D819,221 S * | 5/2018 | Lei | | D24/200 | D901,034 S * | 11/2020 | Zhang | | D24/214 |
| D822,843 S * | 7/2018 | Lenke | | D24/215 | D901,704 S * | 11/2020 | Huang | | D24/214 |
| D825,073 S * | 8/2018 | Lenke | | D24/215 | D901,705 S * | 11/2020 | Du | | D24/214 |
| D829,921 S * | 10/2018 | Xiong | | D24/214 | 2007/0038206 A1 * | 2/2007 | Altshuler | | A61B 18/203 606/20 |
| D835,796 S * | 12/2018 | Sedic | | D24/215 | 2008/0103560 A1 * | 5/2008 | Powell | | A61N 5/0616 607/88 |
| D836,792 S * | 12/2018 | Fuhner | | D24/215 | 2008/0103563 A1 * | 5/2008 | Powell | | A61N 5/0616 607/89 |
| D842,491 S * | 3/2019 | Fleming | | D24/215 | 2008/0106896 A1 * | 5/2008 | Liu | | A61H 9/0057 362/234 |
| D847,363 S * | 4/2019 | Aulwes | | D24/215 | 2009/0177125 A1 * | 7/2009 | Pilcher | | A46B 15/0034 601/18 |
| D848,013 S * | 5/2019 | Fuhner | | D24/215 | 2011/0184499 A1 * | 7/2011 | Radi | | A61N 7/00 607/88 |
| D848,632 S * | 5/2019 | Fuhner | | D24/215 | 2011/0251523 A1 * | 10/2011 | Kim | | A61N 5/0624 601/2 |
| D848,633 S * | 5/2019 | Fuhner | | D24/215 | 2013/0030421 A1 * | 1/2013 | Gomez De Diego | | A61N 5/0616 606/3 |
| D849,257 S * | 5/2019 | Fukuda | | D24/200 | 2013/0046212 A1 * | 2/2013 | Nichols | | A61H 7/005 601/18 |
| D857,911 S * | 8/2019 | Huang | | D24/215 | 2013/0060176 A1 * | 3/2013 | Nichols | | A61H 23/02 601/137 |
| D859,681 S * | 9/2019 | Tang | | D24/214 | 2013/0231592 A1 * | 9/2013 | Lee | | A61H 23/0245 601/2 |
| D860,470 S * | 9/2019 | Li | | D24/214 | 2015/0080991 A1 * | 3/2015 | Britva | | A61B 18/14 607/101 |
| D861,181 S * | 9/2019 | Shen | | D24/209 | 2020/0170399 A1 * | 6/2020 | Truong | | A46B 9/06 |
| D861,908 S * | 10/2019 | Gan | | D24/214 | 2020/0179220 A1 * | 6/2020 | Jablow | | A61H 1/00 |
| D862,717 S * | 10/2019 | Khubani | | D24/200 | 2020/0288843 A1 * | 9/2020 | Verheem | | A45D 19/02 |
| D862,721 S * | 10/2019 | Friend | | D24/214 | | | | | |
| D863,574 S * | 10/2019 | Yan | | D24/200 | | | | | |
| D865,209 S * | 10/2019 | Nichols | | D24/214 | | | | | |
| D870,304 S * | 12/2019 | Du | | D24/214 | | | | | |
| D875,267 S * | 2/2020 | Zeng | | D24/214 | | | | | |
| D887,018 S * | 6/2020 | Yongjoonchoe | | D24/200 | | | | | |
| D892,322 S * | 8/2020 | Yang | | D24/133 | | | | | |
| D894,411 S * | 8/2020 | Jin | | D24/200 | | | | | |
| D894,415 S * | 8/2020 | Blank | | D24/214 | | | | | |
| D895,825 S * | 9/2020 | Jin | | D24/214 | | | | | |
| D897,109 S * | 9/2020 | Blank | | D4/102 | | | | | |

* cited by examiner

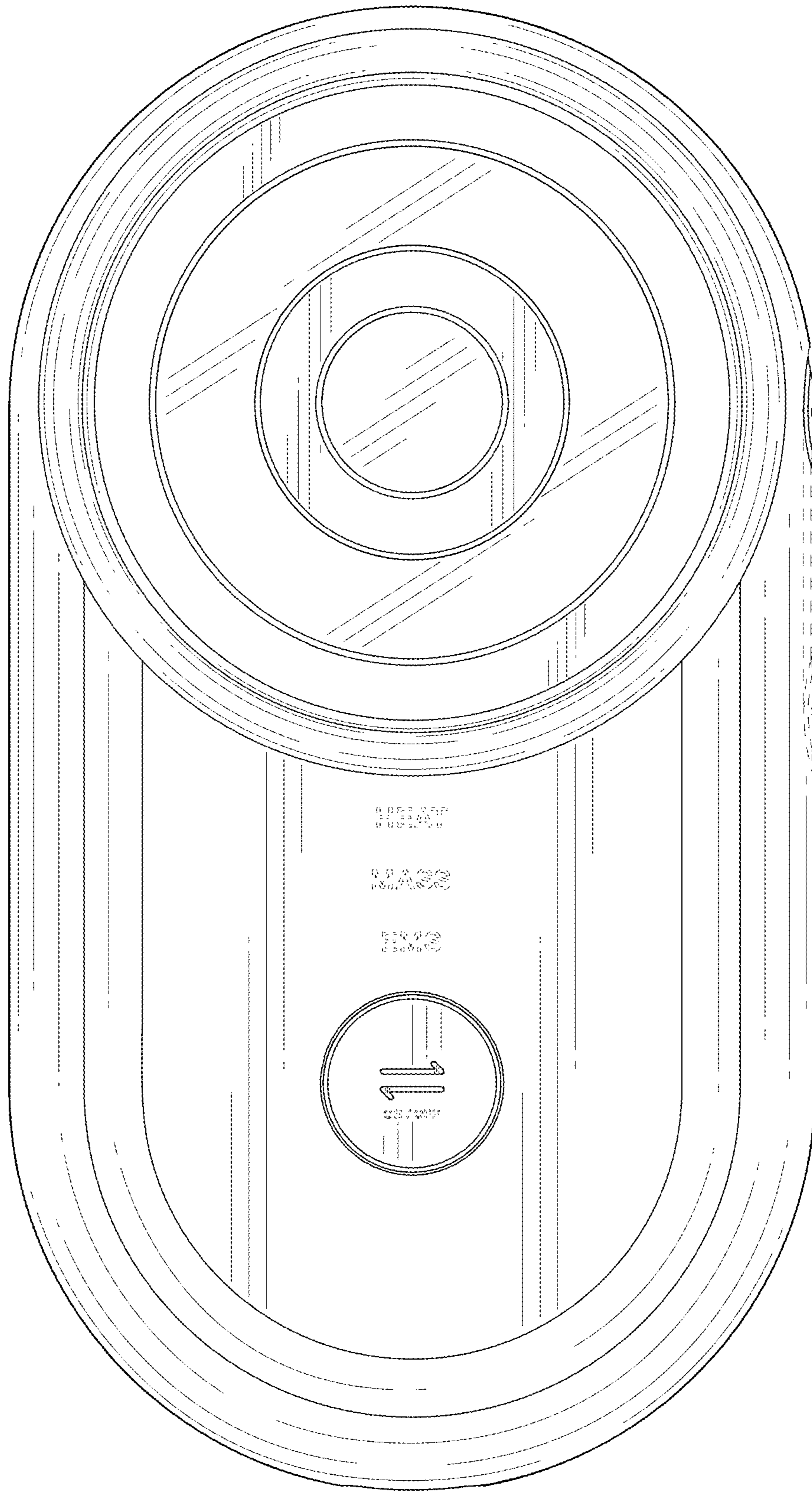

FIG. 1

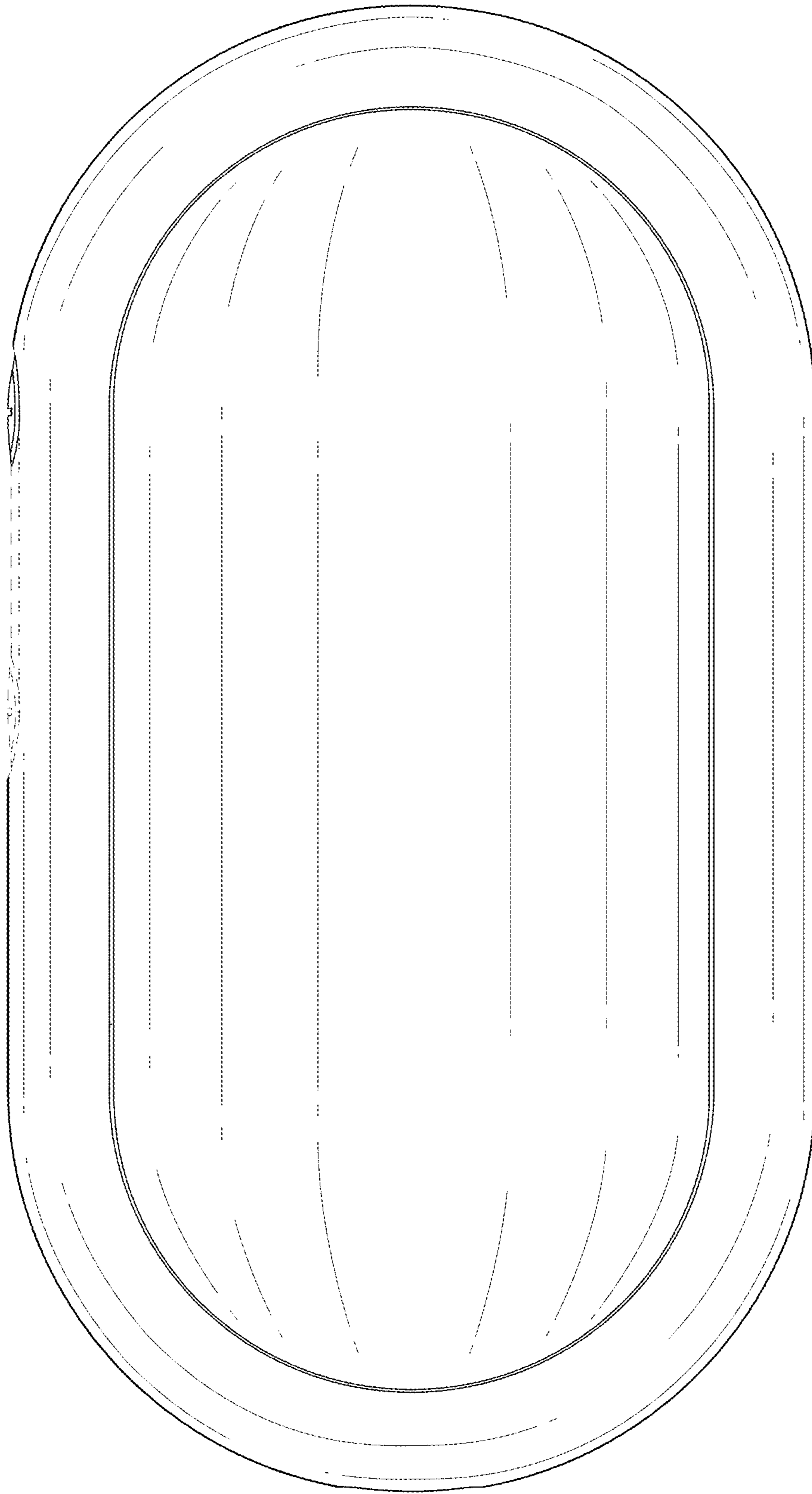

FIG. 2

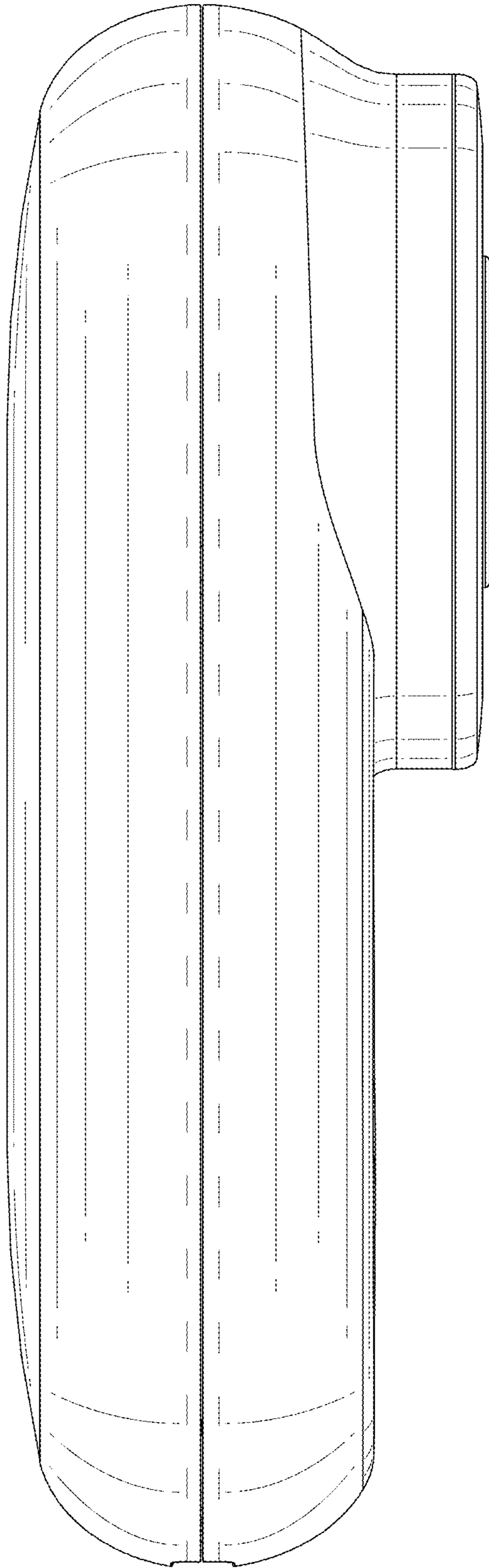

FIG. 3

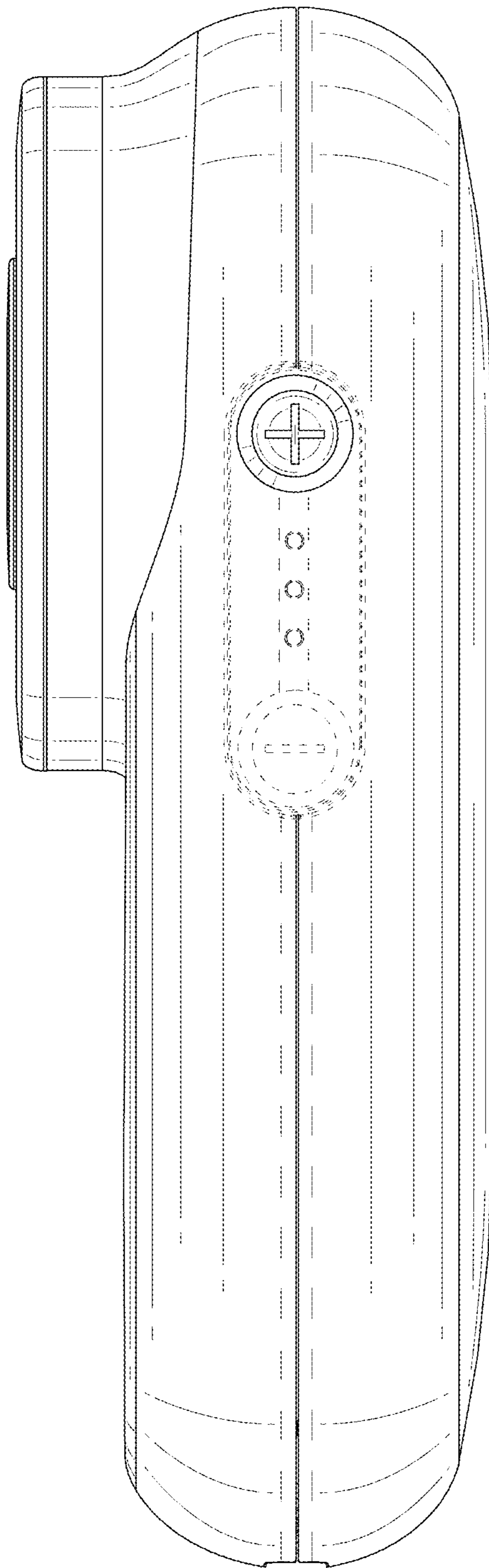

FIG. 4

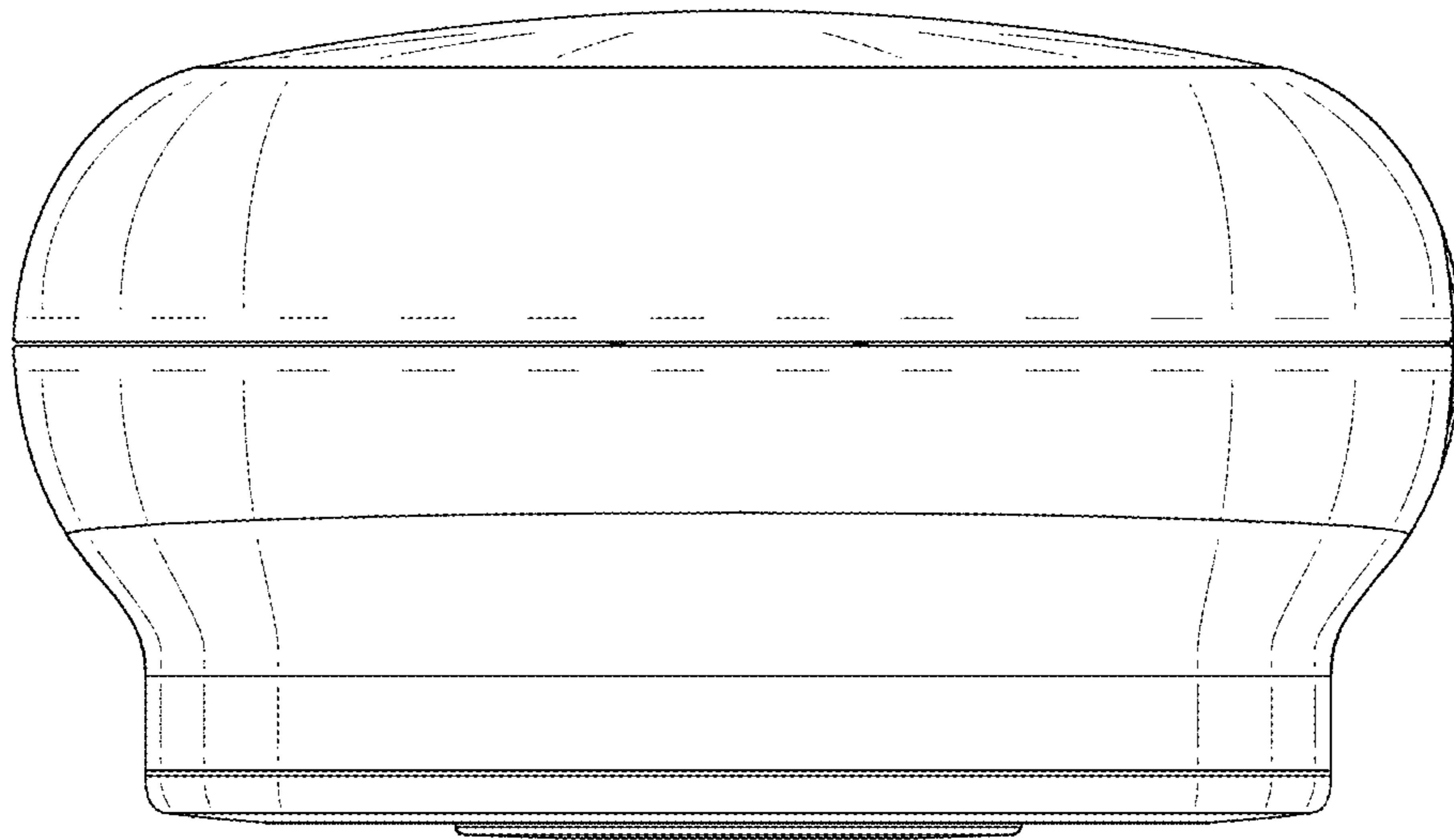

FIG. 5

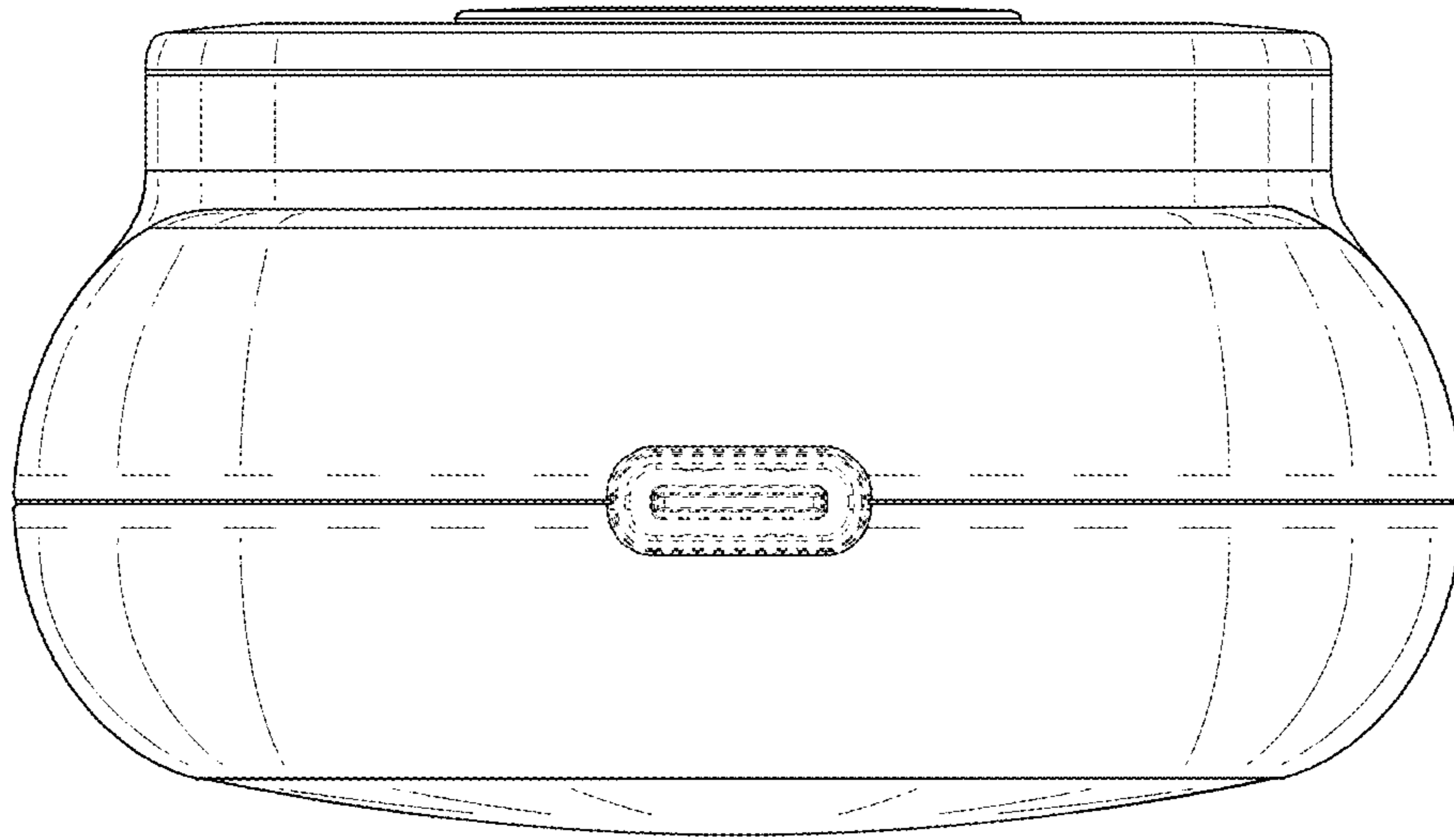

FIG. 6

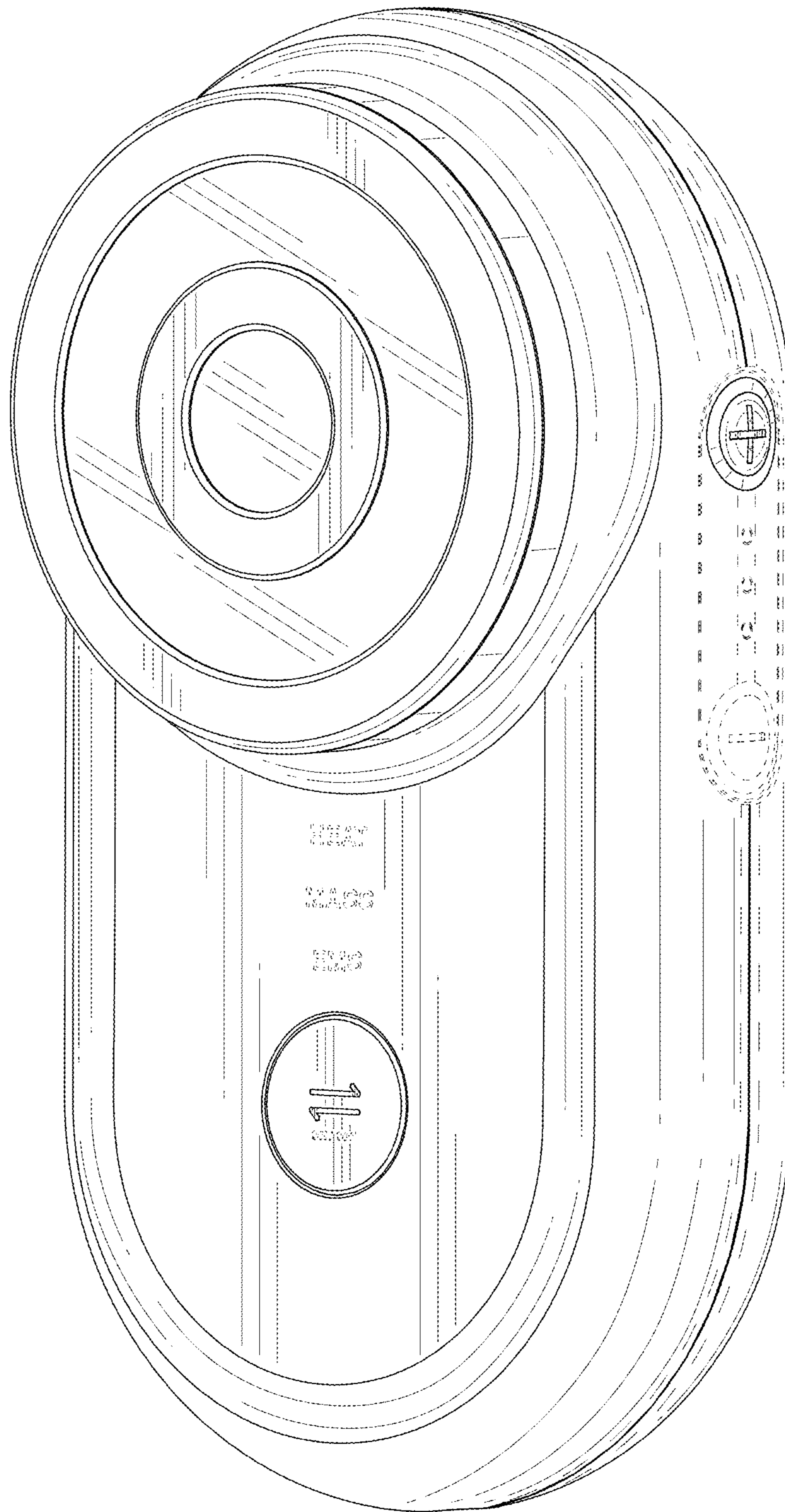

FIG. 7

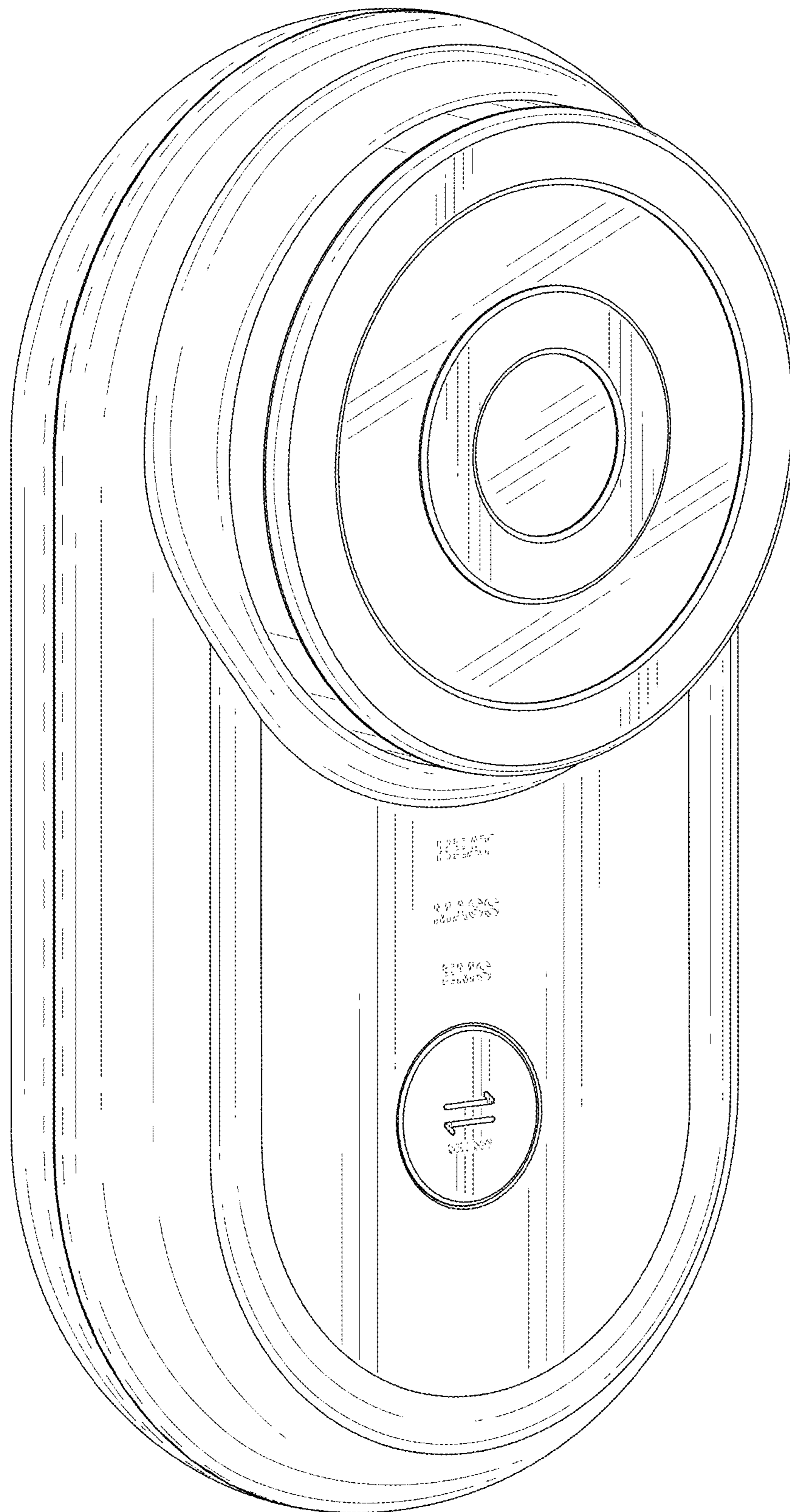

FIG. 8