



US00D916197S

(12) **United States Design Patent**
Peeters et al.

(10) **Patent No.:** **US D916,197 S**
(45) **Date of Patent:** **** Apr. 13, 2021**

(54) **GAME BOARD AND GAME PIECES**

(71) Applicant: **SMART N.V.**, Kontich (BE)

(72) Inventors: **Raf Peeters**, Lier (BE); **Leighton Meredith Rees**, Cirencester (GB)

(73) Assignee: **Smart N.V.**, Kontich (BE)

(**) Term: **15 Years**

(21) Appl. No.: **29/688,013**

(22) Filed: **Apr. 17, 2019**

(30) **Foreign Application Priority Data**

Oct. 30, 2018 (EM) 005816094

(51) **LOC (13) Cl.** **21-01**

(52) **U.S. Cl.**

USPC **D21/360**; D21/350; D21/334

(58) **Field of Classification Search**

USPC D21/334, 335-342, 355-359, 365, 318, D21/397, 351, 385, 386, 389, 404, 478, D21/479, 483-486, 489-491, 493, 494, D21/497, 499, 507, 510, 511, 561; 273/241, 242, 244-247, 259, 271-281, 273/282.1-282.3, 284-287, 317.3, 108.1, 273/108.5, 118 D, 236-240, 283, 309, 273/441, 461, 288-290, 153 R, 156, 273/153 S; D6/406.1, 406.3, 406.4, D6/406.6; D19/86, 92, 95, 87, 113, 75, D19/77, 78, 80, 60, 59, 64, 63; 108/14, 108/62, 43, 67; 434/81, 82, 96, 128, 365, 434/393, 403, 428, 429, 433, 416, 247, 434/248, 251, 408, 413, 145, 430; 446/82-84, 85, 97, 99, 101, 102, 118, 446/124, 268, 330, 476, 491, 901

CPC A63F 3/00; A63F 3/00003; A63F 3/00028; A63F 3/00041; A63F 3/00044; A63F 3/00047; A63F 3/00173; A63F 3/00176; A63F 3/00214; A63F 3/00261; A63F 3/00643; A63F 3/00646-00659; A63F 3/04; A63F 3/00097; A63F 3/0434; A63F

3/00148; A63F 3/00697; A63F 3/0023; A63F 3/00895; A63F 3/00574; A63F 3/00694; A63F 2003/00182; A63F 2003/00223; A63F 2003/00457; A63F 2003/0046; A63F 2003/00463; A63F 2003/00466; A63F 2003/0047; A63F 2003/00485; A63F 2003/00492; A63F 2003/00507; A63F 2003/00514; A63F 2003/00533; A63F 2003/00552; A63F 2003/00558; A63F 2003/00943; A63F 2003/00946; A63F 2003/00952-00962; A63F 2003/00974; A63F 7/00; A63F 7/06; A63F 7/0612; A63F 7/0604; A63F 7/0616-0636; A63F 7/30; A63F 7/36; A63F 7/0005; A63F 7/0017; A63F 7/0023; A63F 2007/0035; A63F 2007/367; A63F 2007/3674; A63F 9/00; A63F 9/08; A63F 9/001; A63F 9/0826; A63F 9/0073; A63F 9/0078; A63F 9/0602; A63F 9/0613; A63F 9/12-1208; A63F 9/1288; A63F 2009/0012; A63F 2009/1212-1228; A63F 2009/1292; A63F 2009/1296

See application file for complete search history.

(56)

References Cited

U.S. PATENT DOCUMENTS

873,031 A * 12/1907 Doan et al. A63F 3/00574
273/282.1
D46,256 S * 8/1914 Lahiere D21/564
1,221,493 A * 4/1917 Whitaker A63F 3/00697
273/282.1
1,343,984 A * 6/1920 Ramsey A63F 3/027
273/282.1
3,170,697 A * 2/1965 Banks A63F 3/065
273/282.1
3,345,071 A * 10/1967 Nekton A63F 3/022
273/282.1
3,531,122 A * 9/1970 Peebles A63F 3/00697
273/282.1
3,588,112 A * 6/1971 Holt A63F 3/00574
273/282.1
3,589,060 A * 6/1971 Genin A63H 13/20
446/246

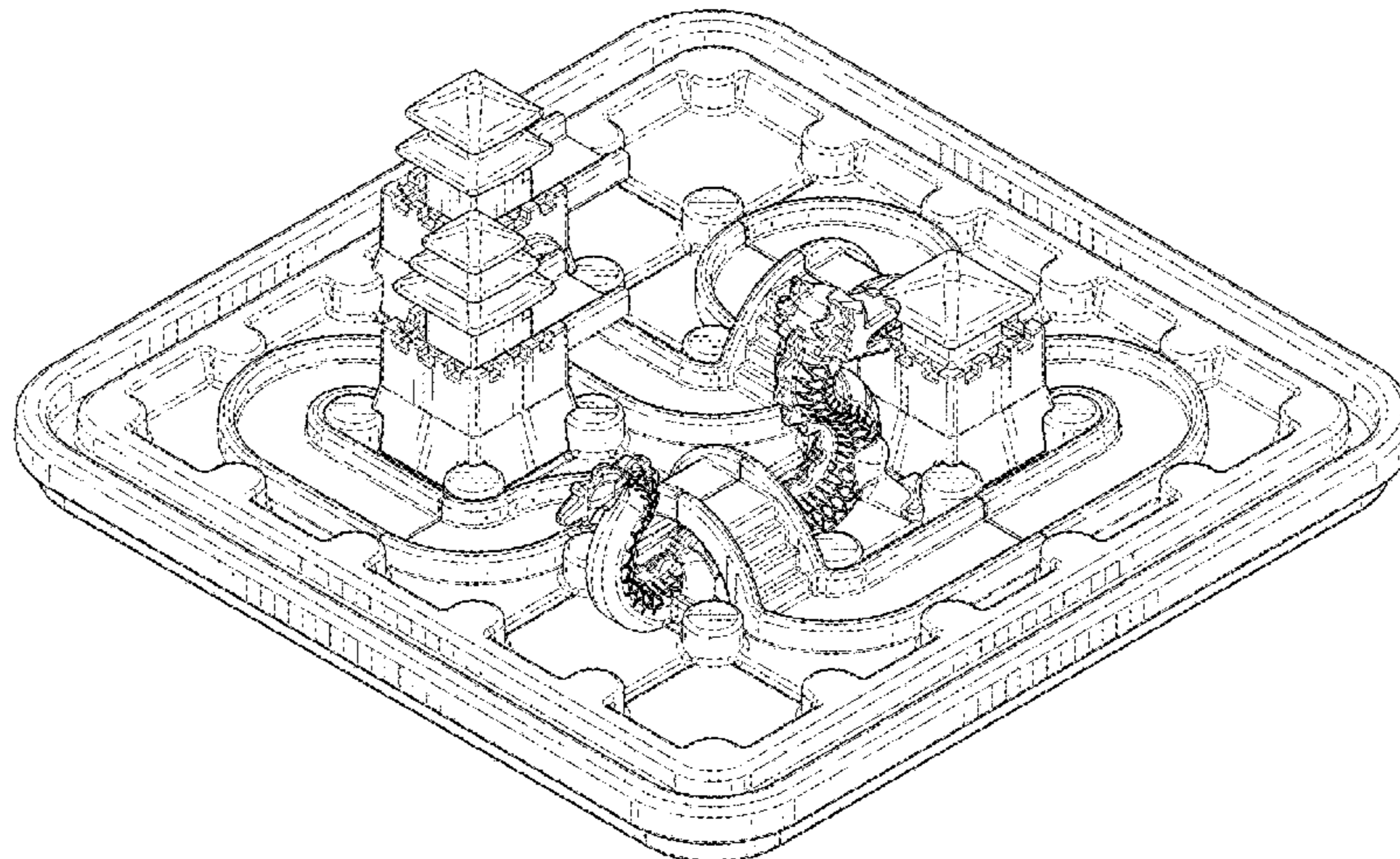

3,698,122 A * 10/1972 Adams A63F 9/10
446/118
3,751,827 A * 8/1973 Gaskin G09B 23/40
434/152
3,751,849 A * 8/1973 Goldfarb A63H 13/04
446/246
3,754,759 A * 8/1973 Breslow A63F 9/30
273/440
3,823,944 A * 7/1974 Stubbmann A63F 3/0695
273/281
4,067,576 A * 1/1978 Balas A63F 7/0076
273/120 R
4,136,883 A * 1/1979 Klees A63F 3/00261
273/281
D252,953 S * 9/1979 Pagani D21/338
4,175,742 A * 11/1979 Todokoro A63F 9/30
273/447
4,224,761 A * 9/1980 Wakimura A63F 9/305
273/237
4,228,615 A * 10/1980 Melotti A63H 3/16
446/99
4,229,003 A * 10/1980 Shimizu A63F 9/34
273/448
4,234,181 A * 11/1980 Breslow A63F 9/30
273/440
D264,857 S * 6/1982 Aitkens D21/338
4,418,908 A * 12/1983 Kinberg A63F 9/0079
273/108
D272,253 S * 1/1984 Du Plessis D21/338
4,504,243 A * 3/1985 Barlow A63F 3/00634
446/444
4,512,584 A * 4/1985 Propsom A63F 3/00574
273/282.1
4,524,967 A * 6/1985 Hanson A63F 9/30
273/273
4,551,103 A * 11/1985 Vitale A63F 3/00063
434/225
4,685,884 A * 8/1987 Rohan G09B 25/06
273/157 R
D299,499 S * 1/1989 Gould D21/478
D300,441 S * 3/1989 Ryland D21/609
4,838,553 A * 6/1989 Chaun-Tien A63F 9/305
273/447
5,219,170 A * 6/1993 Ledford A63F 3/00574
273/248
D339,390 S * 9/1993 Lammertink D21/478
D347,662 S * 6/1994 Johnson D21/351
D349,530 S * 8/1994 Pedersen D21/615
D349,538 S * 8/1994 Pedersen D21/615
5,427,379 A * 6/1995 Lee A63F 3/00634
273/264
D367,502 S * 2/1996 Armendariz D21/478
D371,578 S * 7/1996 Henderson D21/338
5,558,336 A * 9/1996 Sapello A63F 3/00634
273/281
D379,387 S * 5/1997 Stephensen D21/654
5,702,108 A * 12/1997 Todokoro A63F 9/30
273/120 R
D389,872 S * 1/1998 Rhea D21/360
D390,279 S * 2/1998 Foster D21/360
D395,468 S * 6/1998 Wagner D21/478
5,827,105 A * 10/1998 Felgenhauer A63H 19/36
446/120
D400,936 S * 11/1998 Wagner D21/478
D405,128 S * 2/1999 Vallier D21/350
6,345,822 B1 * 2/2002 Reynolds A63F 3/00261
273/281
D456,468 S * 4/2002 Roker D21/654
6,551,164 B1 * 4/2003 Motosko A63G 1/30
280/1.13
D491,234 S * 6/2004 Rom D21/478
D501,231 S * 1/2005 Rom D21/478
D517,619 S * 3/2006 Saruhashi D21/576
D535,337 S * 1/2007 Liu D21/300
D535,704 S * 1/2007 Chow D21/300
D539,359 S * 3/2007 Rom D21/478
D586,230 S * 2/2009 Pierre D21/655

D660,371 S * 5/2012 Fuchs D21/338
D667,506 S * 9/2012 Peeters D21/478
D698,094 S * 1/2014 Paculdo D30/121
8,870,185 B2 * 10/2014 Cheng A63F 3/00574
273/281
8,998,670 B1 * 4/2015 De Leon A63H 3/46
446/97
D753,242 S * 4/2016 Jaensch D21/626
D754,803 S * 4/2016 Jaensch D21/621
D755,311 S * 5/2016 Jaensch D21/649
D773,557 S * 12/2016 Huang D19/59
D894,291 S * 8/2020 Poulus D21/478
2016/0067619 A1 * 3/2016 Botterill A63H 33/04
446/99

* cited by examiner

Primary Examiner — Susan Moon Lee

(74) Attorney, Agent, or Firm — Hodgson Russ LLP

(57) CLAIM

The ornamental design for a game board and game pieces as shown and described.

DESCRIPTION

FIG. 1 is a top perspective view of the game board component shown separately for clarity of illustration; FIG. 2 is a right side view of the game board of FIG. 1; FIG. 3 is a left side view of the game board of FIG. 1; FIG. 4 is a front elevational view of the game board of FIG. 1; FIG. 5 is a rear elevational view of the game board of FIG. 1; FIG. 6 is a top view of the game board of FIG. 1; FIG. 7 is a bottom view of the game board of FIG. 1; FIG. 8 is a top perspective view of a game piece, shown separately for clarity of illustration; FIG. 9 is a front elevational view of the game piece of FIG. 8; FIG. 10 is a rear elevational view of the game piece of FIG. 8; FIG. 11 is a right side view of the game piece of FIG. 8; FIG. 12 is a left side view of the game piece of FIG. 8; FIG. 13 is a top view of the game piece of FIG. 8; FIG. 14 is a bottom view of the game piece of FIG. 8; FIG. 15 is a top perspective view of a game piece, shown separately for clarity of illustration; FIG. 16 is a front elevational view of the game piece of FIG. 15; FIG. 17 is a rear elevational view of the game piece of FIG. 15; FIG. 18 is a right side view of the game piece of FIG. 15; FIG. 19 is a left side view of the game piece of FIG. 15; FIG. 20 is a top view of the game piece of FIG. 15; FIG. 21 is a bottom view of the game piece of FIG. 15; FIG. 22 is a top perspective view of a game piece, shown separately for clarity of illustration; FIG. 23 is a front elevational view of the game piece of FIG. 22; FIG. 24 is a rear elevational view of the game piece of FIG. 22; FIG. 25 is a left side view of the game piece of FIG. 22; FIG. 26 is a right side view of the game piece of FIG. 22; FIG. 27 is a top view of the game piece of FIG. 22; FIG. 28 is a bottom view of the game piece of FIG. 22; FIG. 29 is a top perspective view of a game piece, shown separately for clarity of illustration;

FIG. 30 is a front elevational view of the game piece of FIG. 29;
FIG. 31 is a rear elevational view of the game piece of FIG. 29;
FIG. 32 is a right side view of the game piece of FIG. 29;
FIG. 33 is a left side view of the game piece of FIG. 29;
FIG. 34 is a top view of the game piece of FIG. 29;
FIG. 35 is a bottom view of the game piece of FIG. 29;
FIG. 36 is a top perspective view of a game piece, shown separately for clarity of illustration;
FIG. 37 is a front elevational view of the game piece of FIG. 36;
FIG. 38 is a rear elevational view of the game piece of FIG. 36;
FIG. 39 is a right side view of the game piece of FIG. 36;
FIG. 40 is a left side view of the game piece of FIG. 36;
FIG. 41 is a top view of the game piece of FIG. 36;
FIG. 42 is a bottom view of the game piece of FIG. 36;
FIG. 43 is a top perspective view of a game piece, shown separately for clarity of illustration;
FIG. 44 is a front elevational view of the game piece of FIG. 43;
FIG. 45 is a rear elevational view of the game piece of FIG. 43;
FIG. 46 is a right side view of the game piece of FIG. 43;
FIG. 47 is a left side view of the game piece of FIG. 43;
FIG. 48 is a top view of the game piece of FIG. 43;
FIG. 49 is a bottom view of the game piece of FIG. 43;
FIG. 50 is a top perspective view of a game piece, shown separately for clarity of illustration;
FIG. 51 is a front elevational view of the game piece of FIG. 50;
FIG. 52 is a rear elevational view of the game piece of FIG. 50;
FIG. 53 is a right side view of the game piece of FIG. 50;
FIG. 54 is a left side view of the game piece of FIG. 50;
FIG. 55 is a top view of the game piece of FIG. 50;
FIG. 56 is a bottom view of the game piece of FIG. 50;
FIG. 57 is a top perspective view of a game piece, shown separately for clarity of illustration;

FIG. 58 is a front elevational view of the game piece of FIG. 57;
FIG. 59 is a rear elevational view of the game piece of FIG. 57;
FIG. 60 is a right side view of the game piece of FIG. 57;
FIG. 61 is a left side view of the game piece of FIG. 57;
FIG. 62 is a top view of the game piece of FIG. 57;
FIG. 63 is a bottom view of the game piece of FIG. 57;
FIG. 64 is a top perspective view of a game piece, shown separately for clarity of illustration;
FIG. 65 is a front elevational view of the game piece of FIG. 64;
FIG. 66 is a rear elevational view of the game piece of FIG. 64;
FIG. 67 is a right side view of the game piece of FIG. 64;
FIG. 68 is a left side view of the game piece of FIG. 64;
FIG. 69 is a top view of the game piece of FIG. 64;
FIG. 70 is a bottom view of the game piece of FIG. 64;
FIG. 71 is a top perspective view of a game piece, shown separately for clarity of illustration;
FIG. 72 is a front elevational view of the game piece of FIG. 71;
FIG. 73 is a rear elevational view of the game piece of FIG. 71;
FIG. 74 is a right side view of the game piece of FIG. 71;
FIG. 75 is a left side view of the game piece of FIG. 71;
FIG. 76 is a top view of the game piece of FIG. 71;
FIG. 77 is a bottom view of the game piece of FIG. 71;
FIG. 78 is a top perspective view of a game piece, shown separately for clarity of illustration;
FIG. 79 is a front elevational view of the game piece of FIG. 78;
FIG. 80 is a rear elevational view of the game piece of FIG. 78;
FIG. 81 is a right side view of the game piece of FIG. 78;
FIG. 82 is a left side view of the game piece of FIG. 78;
FIG. 83 is a top view of the game piece of FIG. 78;
FIG. 84 is a bottom view of the game piece of FIG. 78; and,
FIG. 85 is a top perspective view of the game board and game pieces in accordance with our new design.

1 Claim, 71 Drawing Sheets

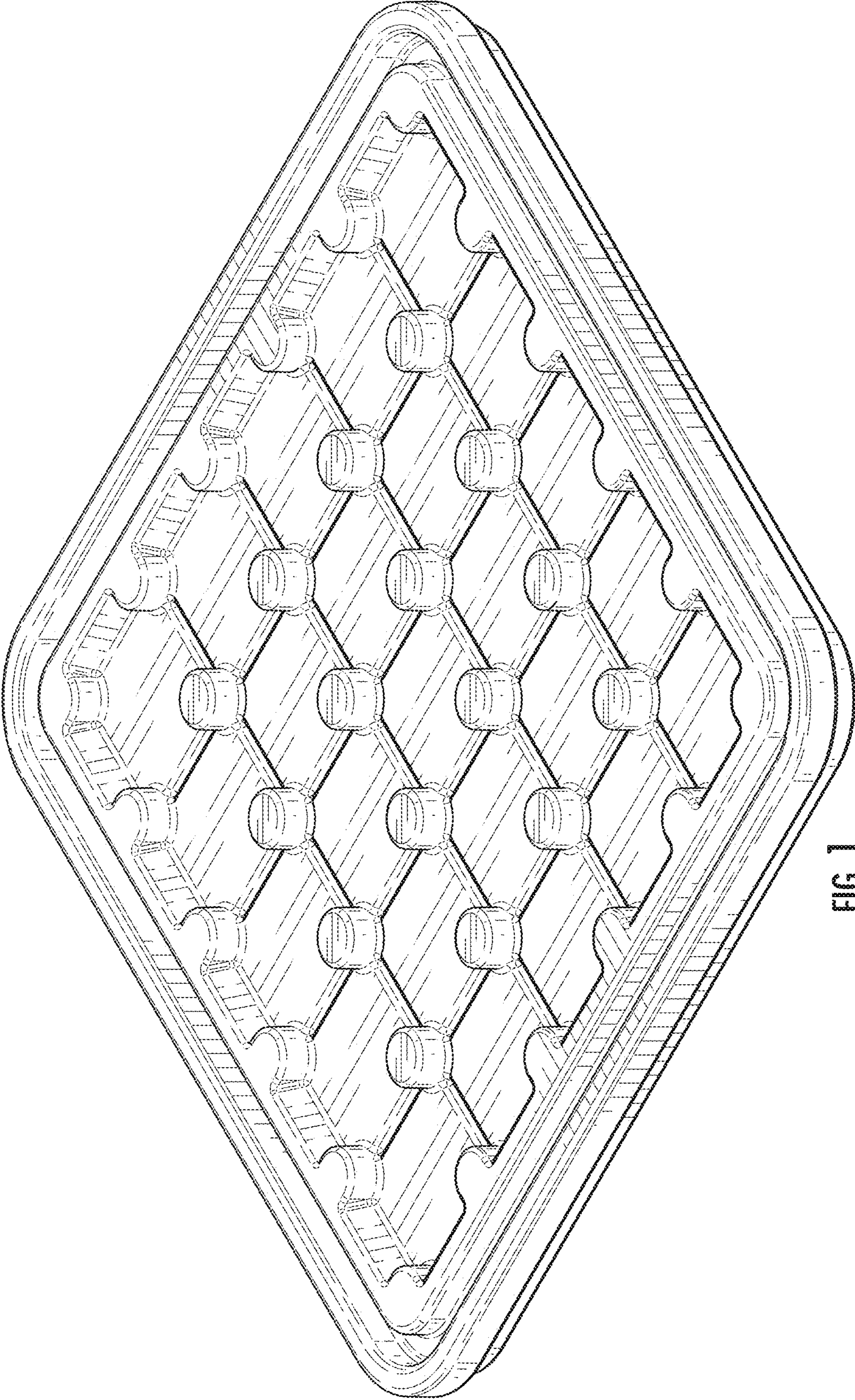

FIG. 1

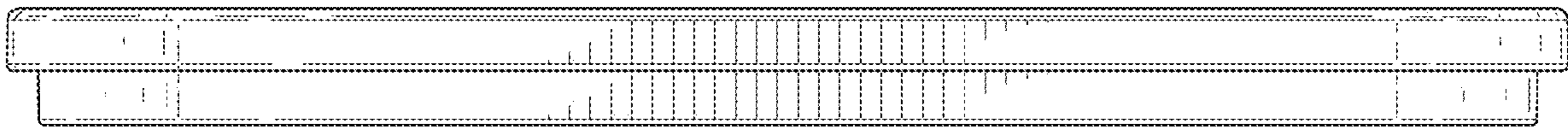

FIG. 2

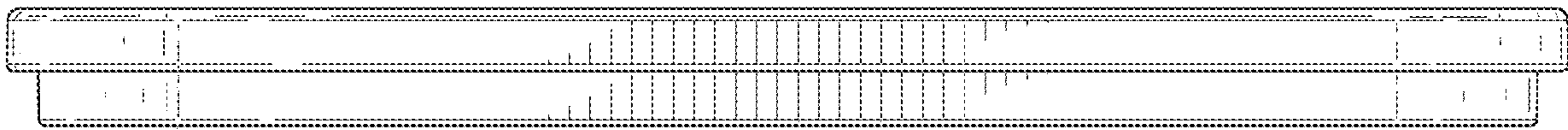

FIG. 3

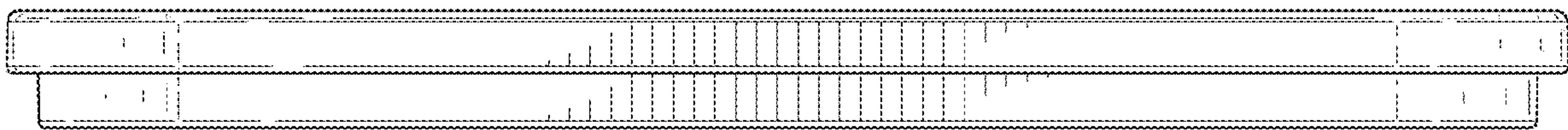

FIG. 4

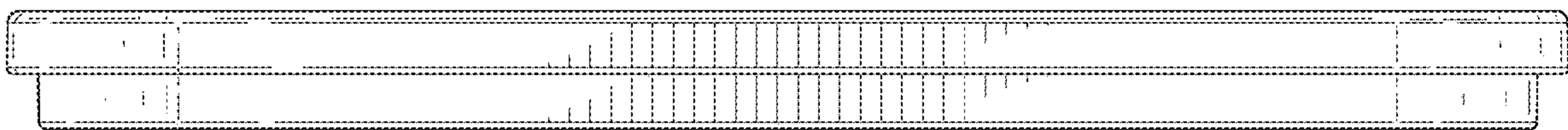

FIG. 5

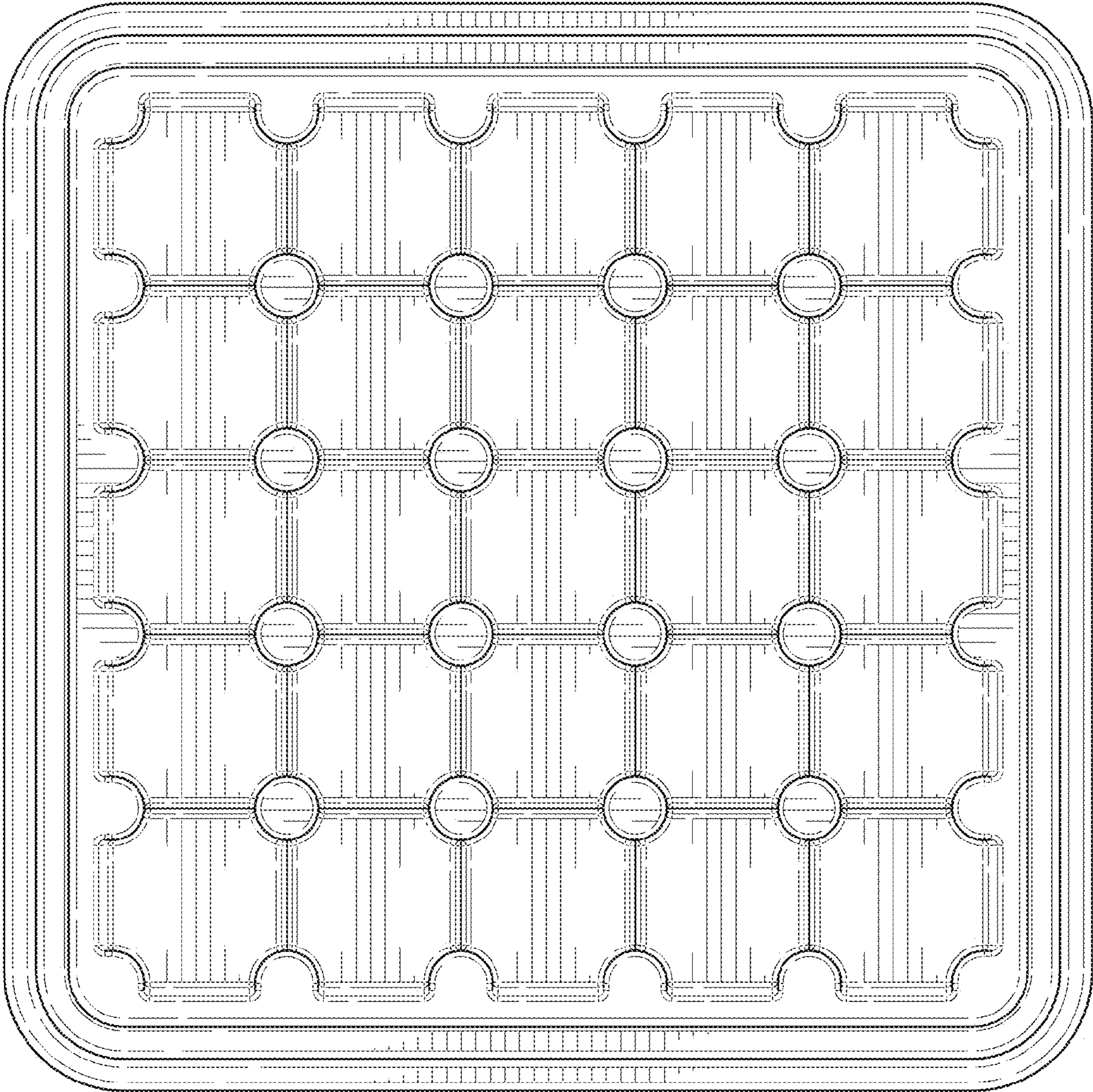

FIG. 6

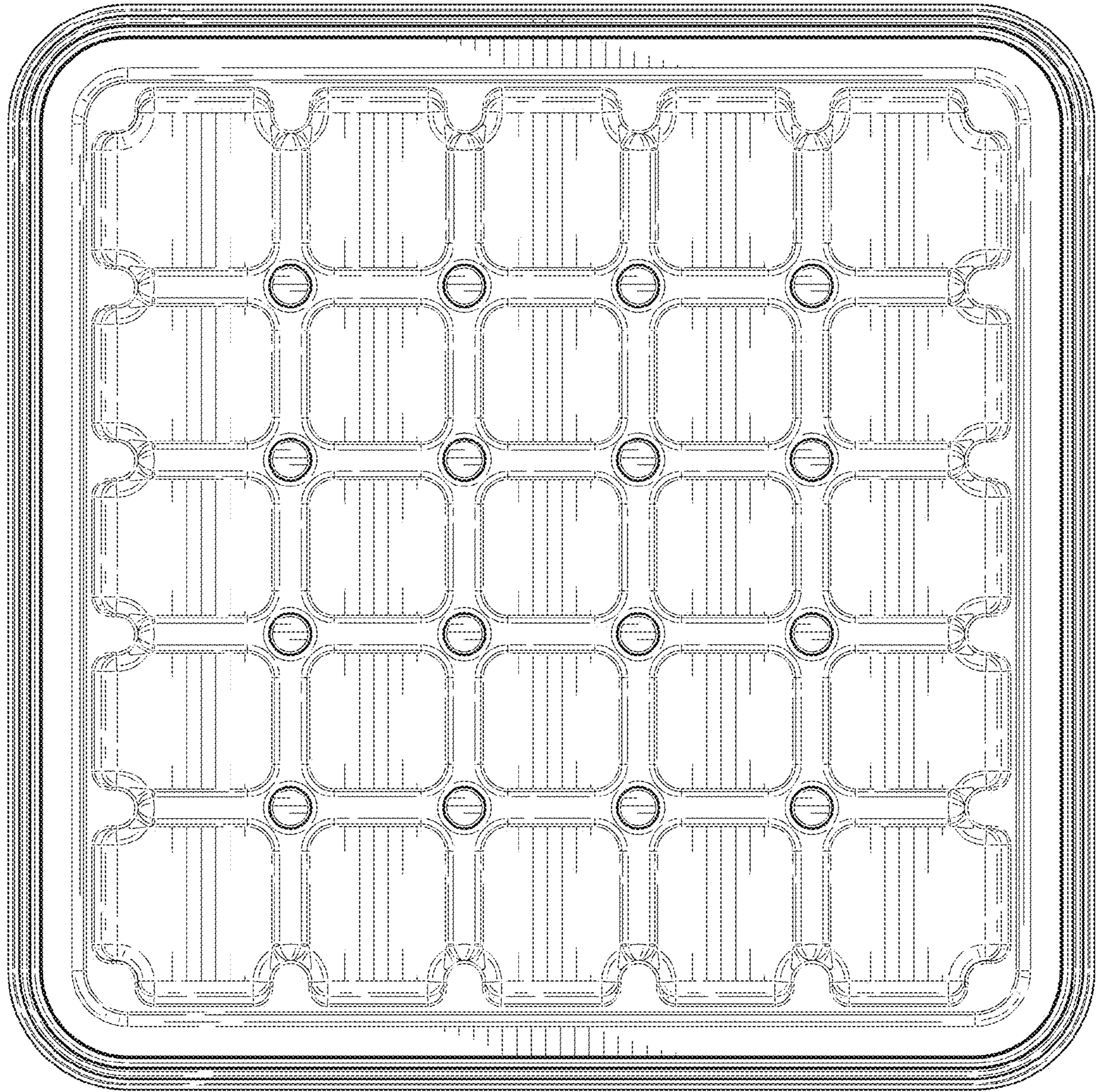

FIG. 7

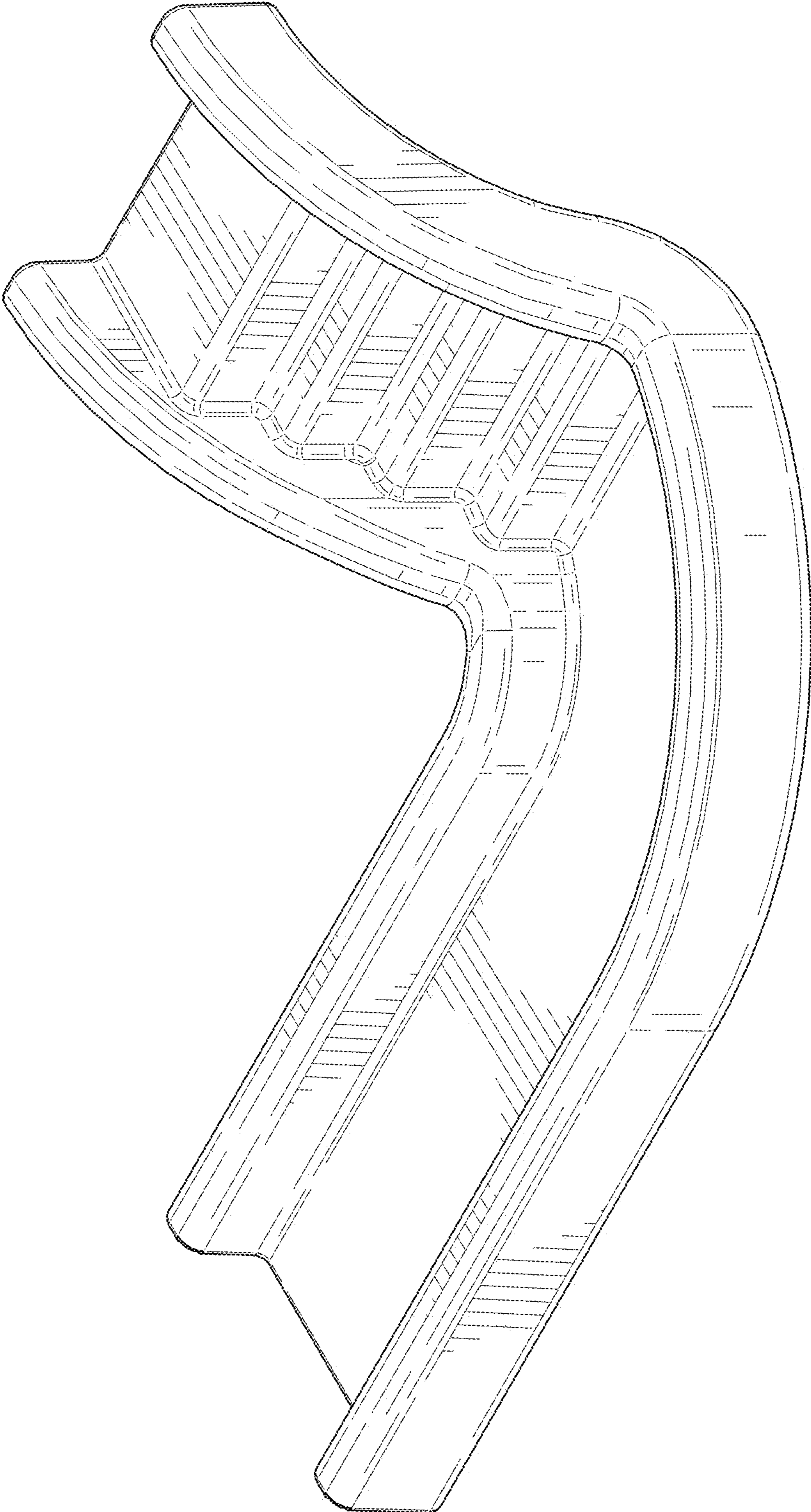

FIG. 8

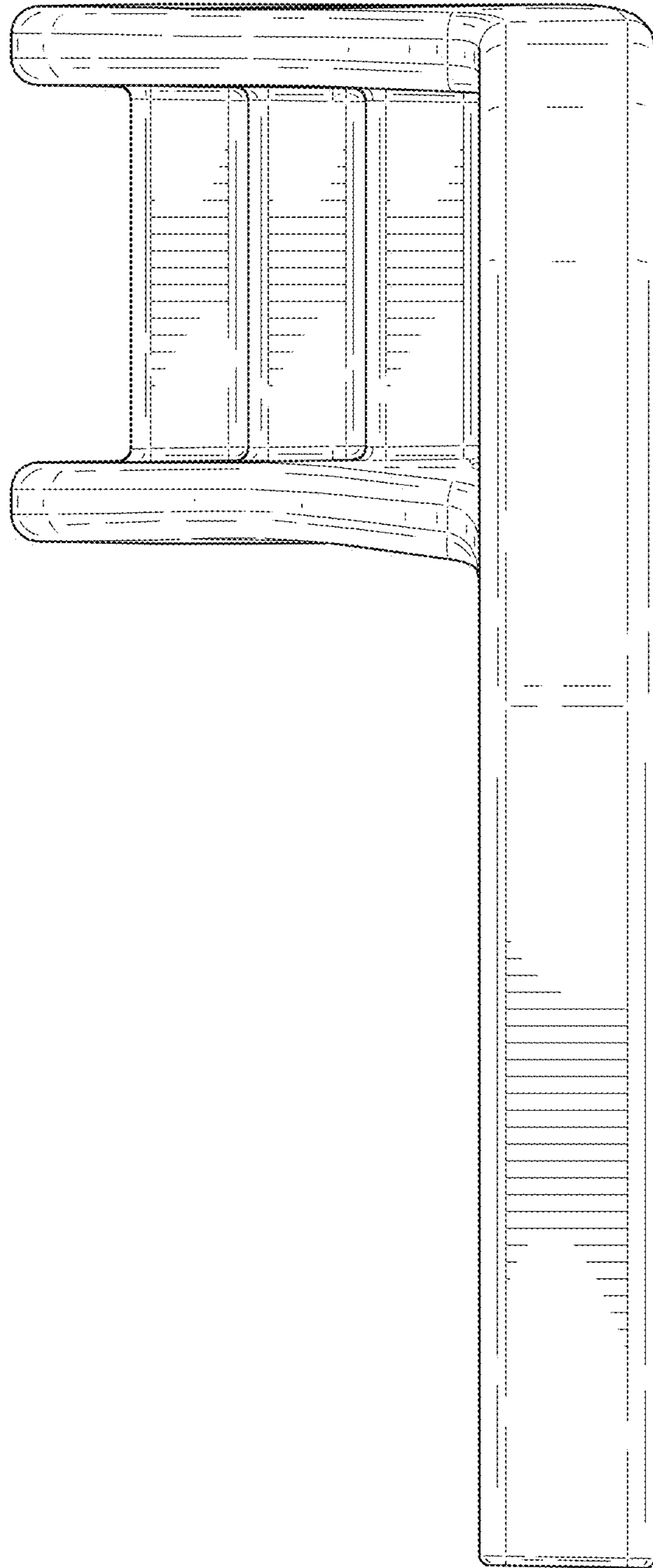

FIG. 9

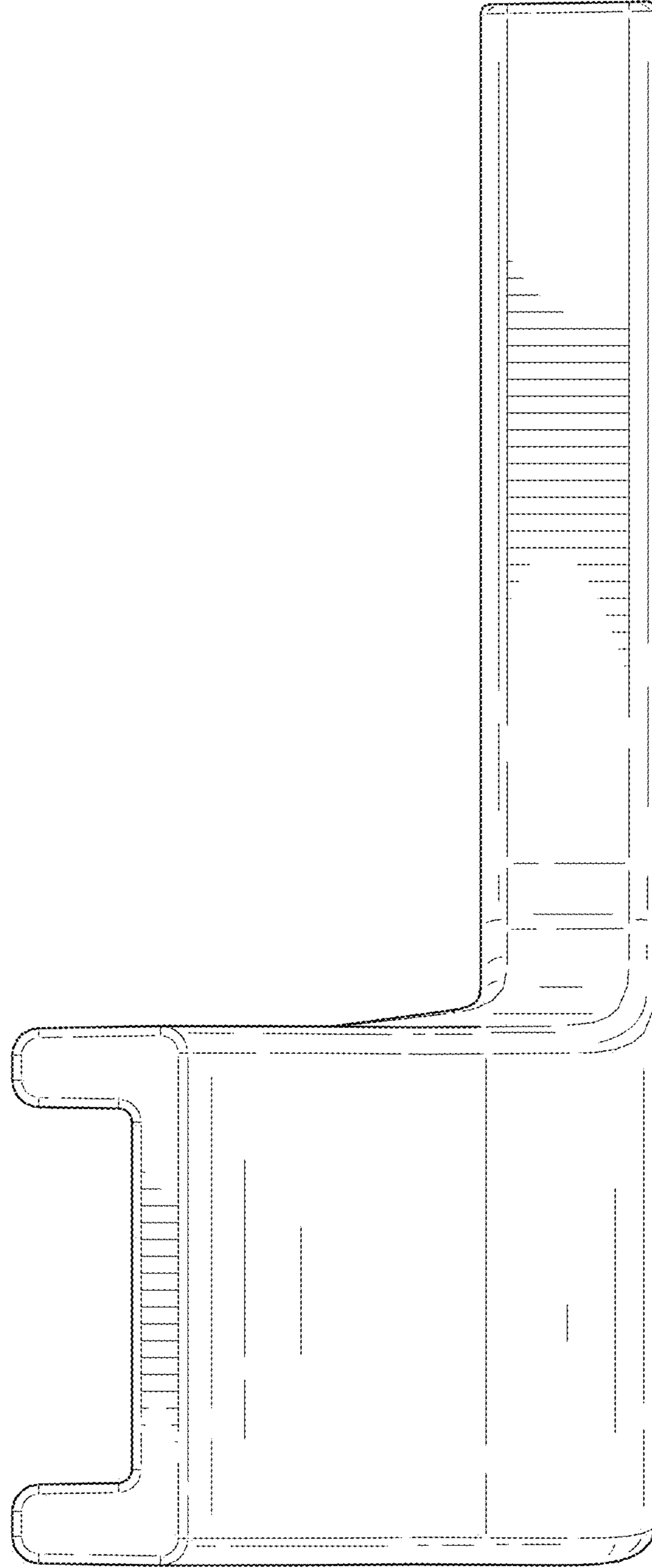

FIG. 10

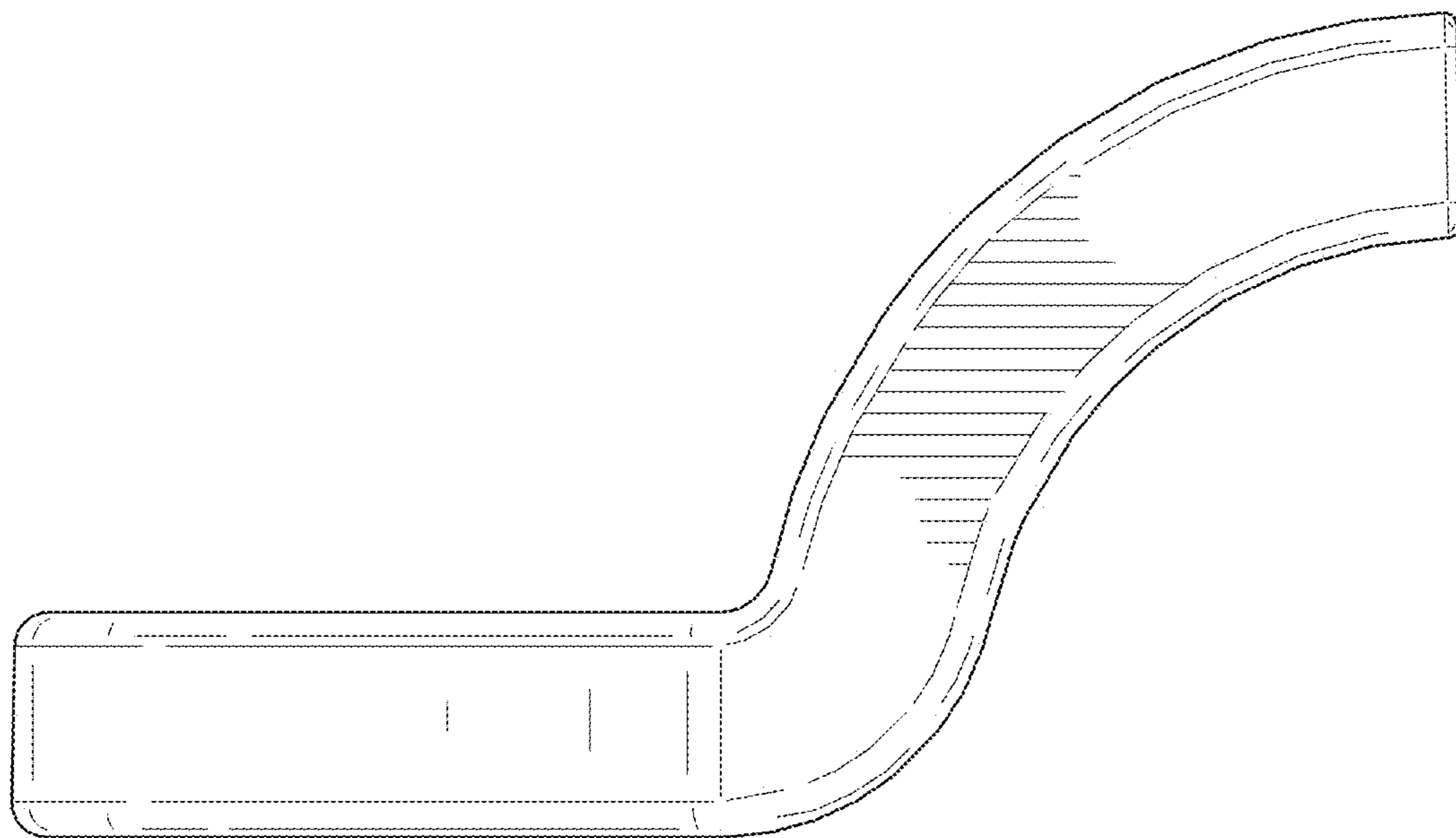

FIG. 11

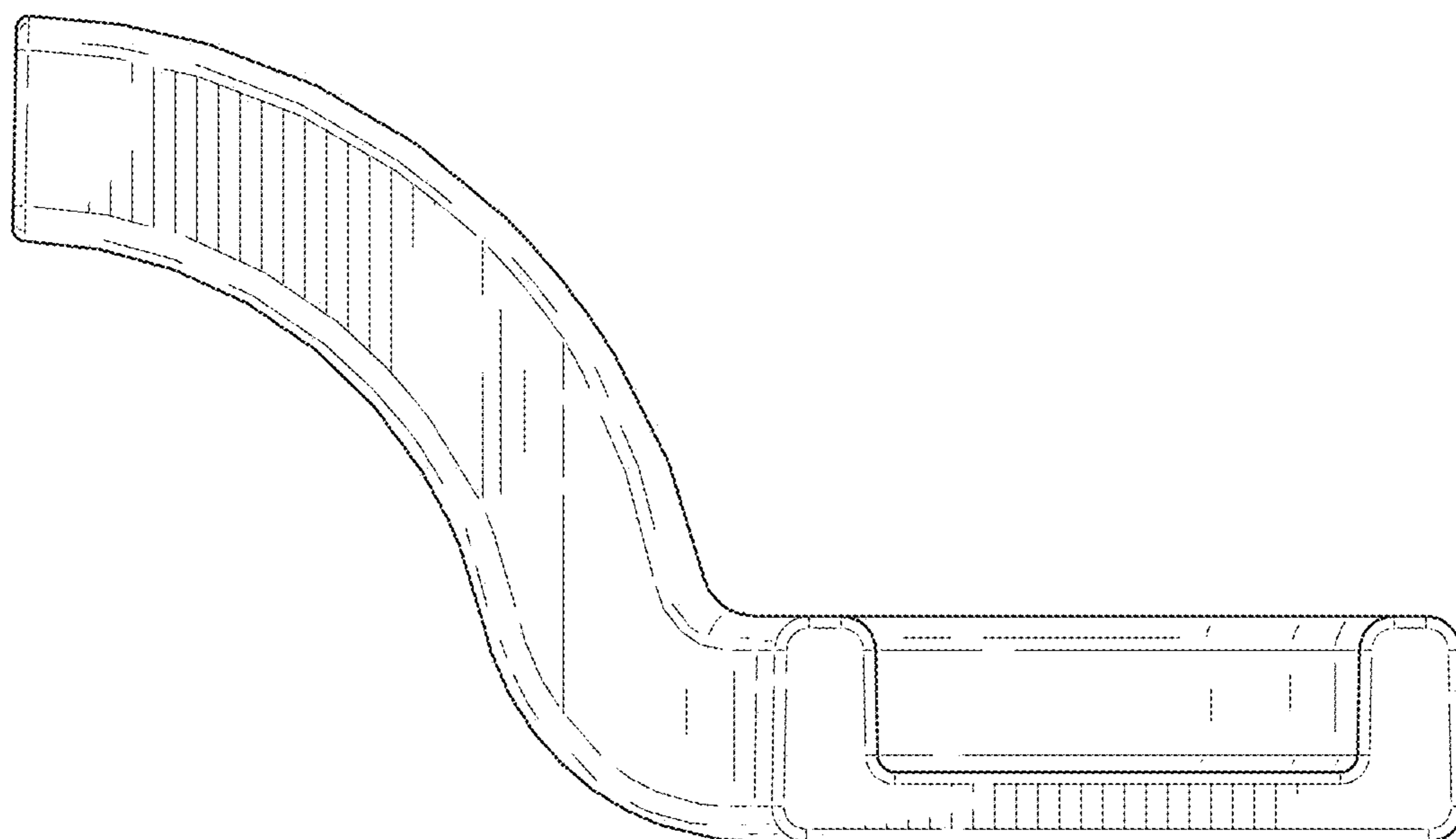

FIG. 12

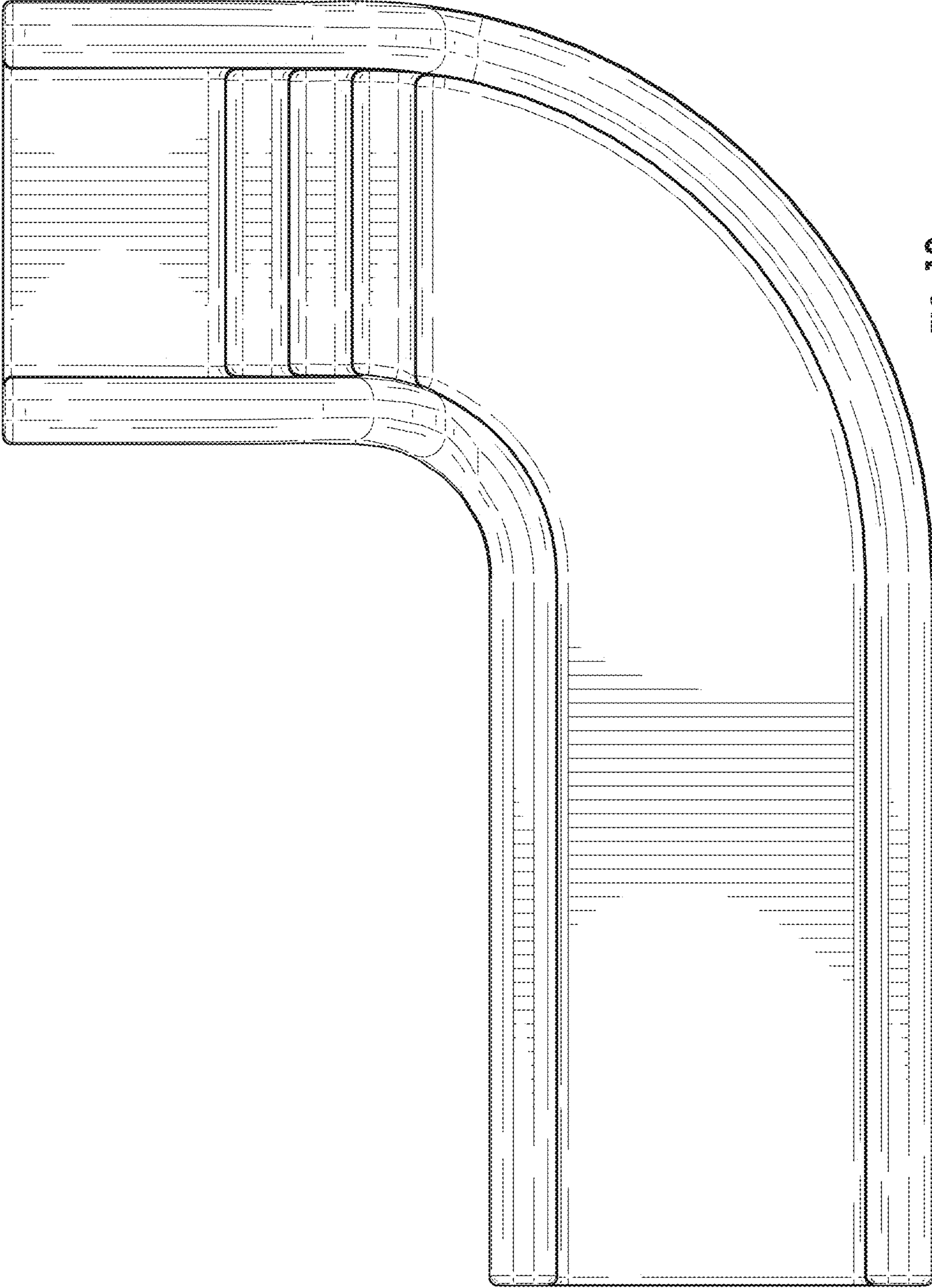

FIG. 13

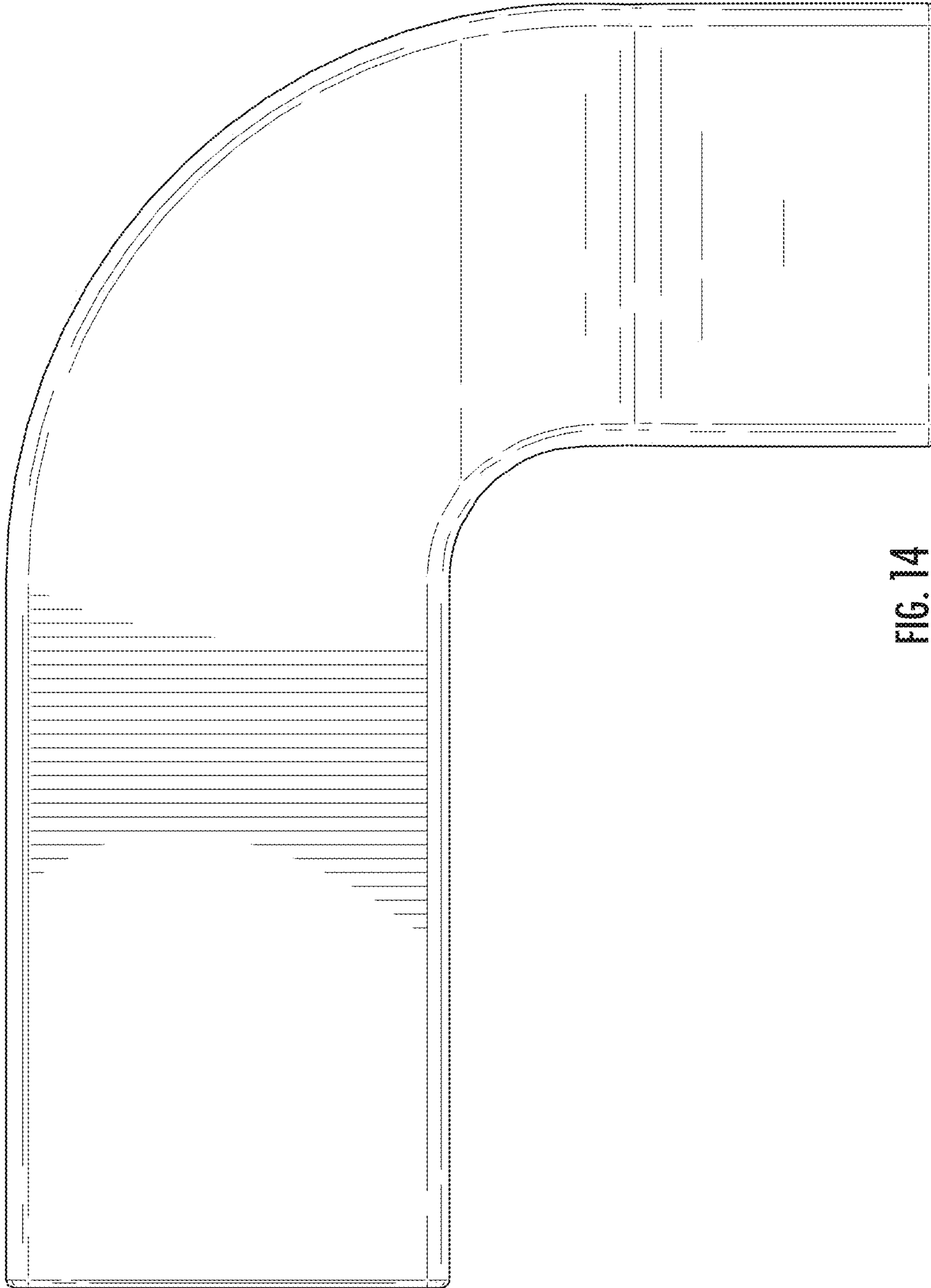

FIG. 14

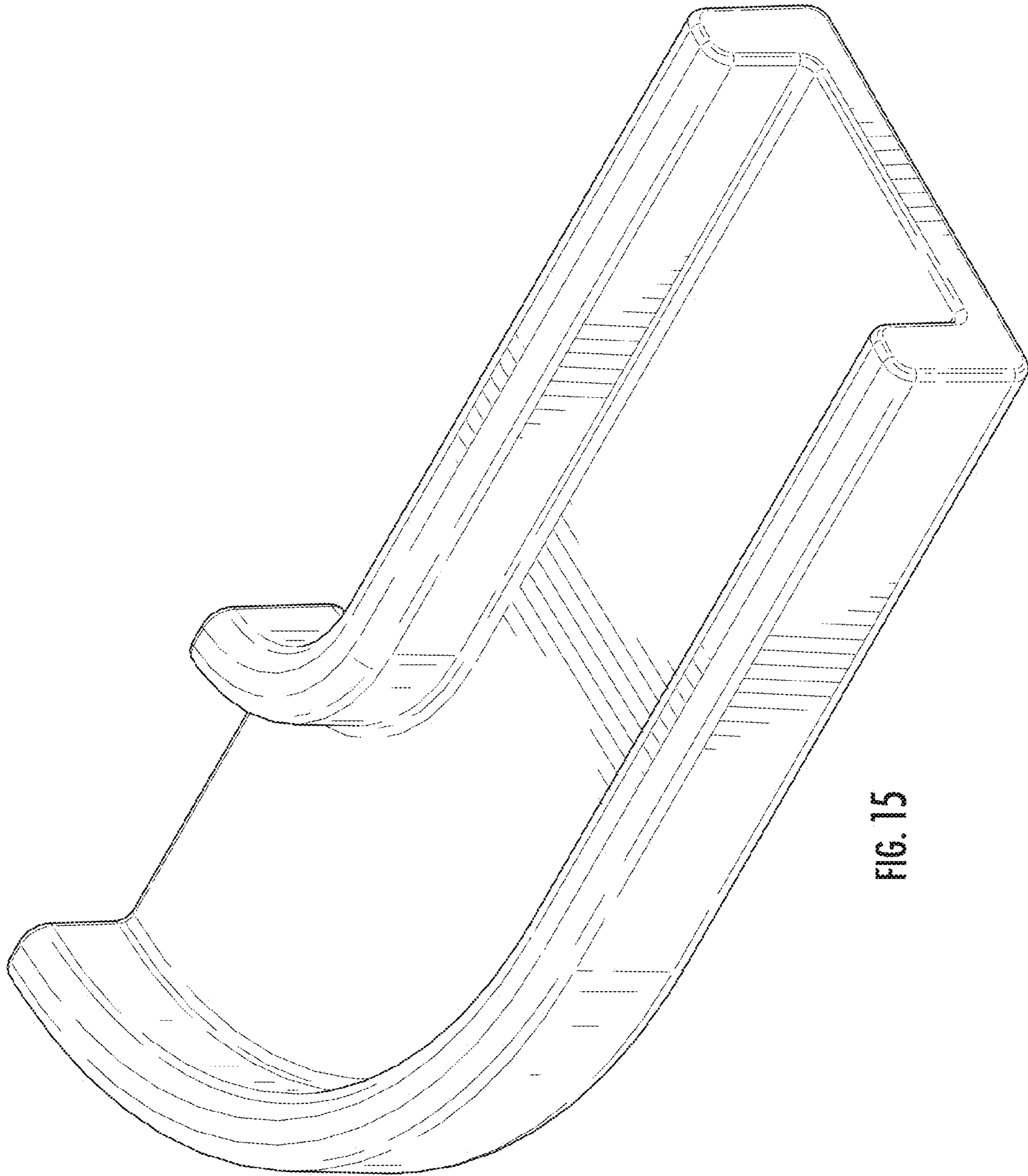

FIG. 15

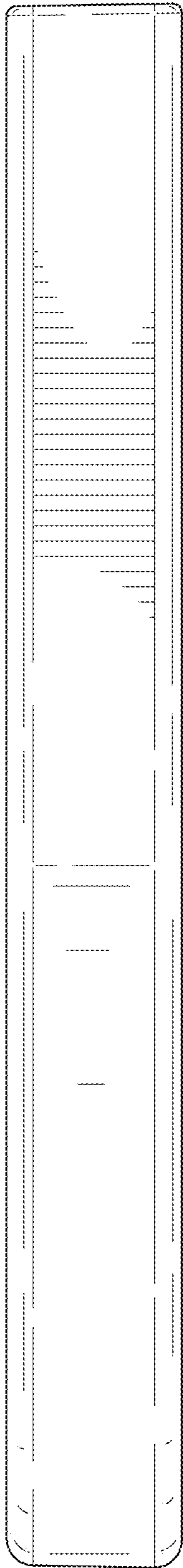

FIG. 16

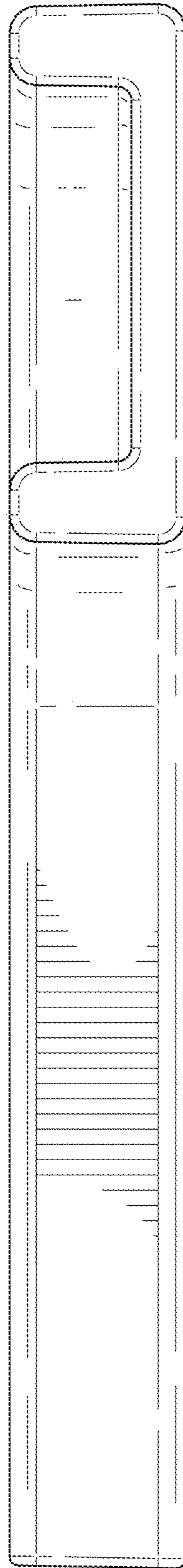

FIG. 17

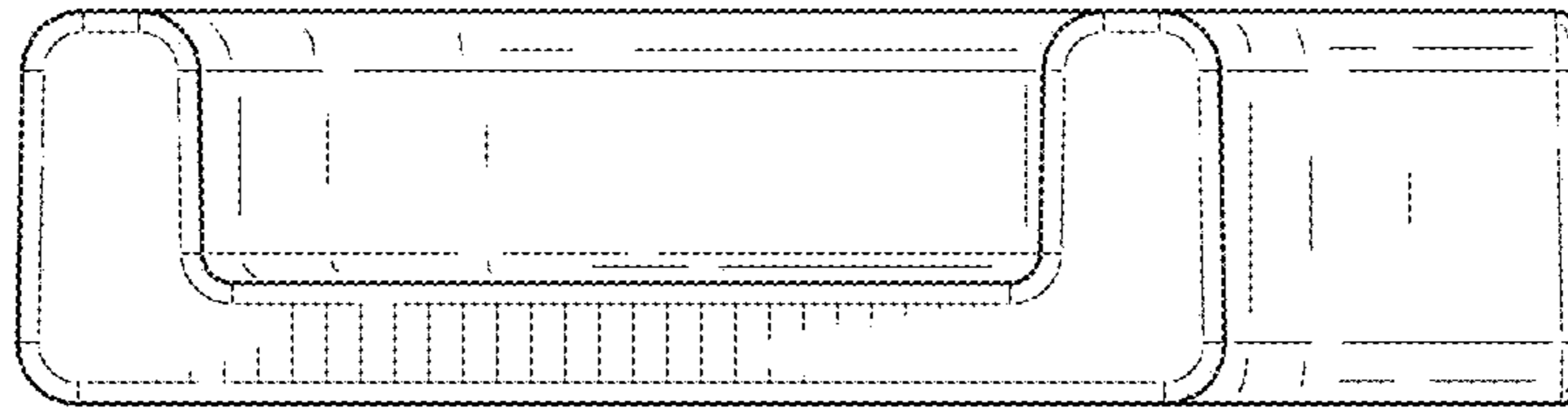

FIG. 18

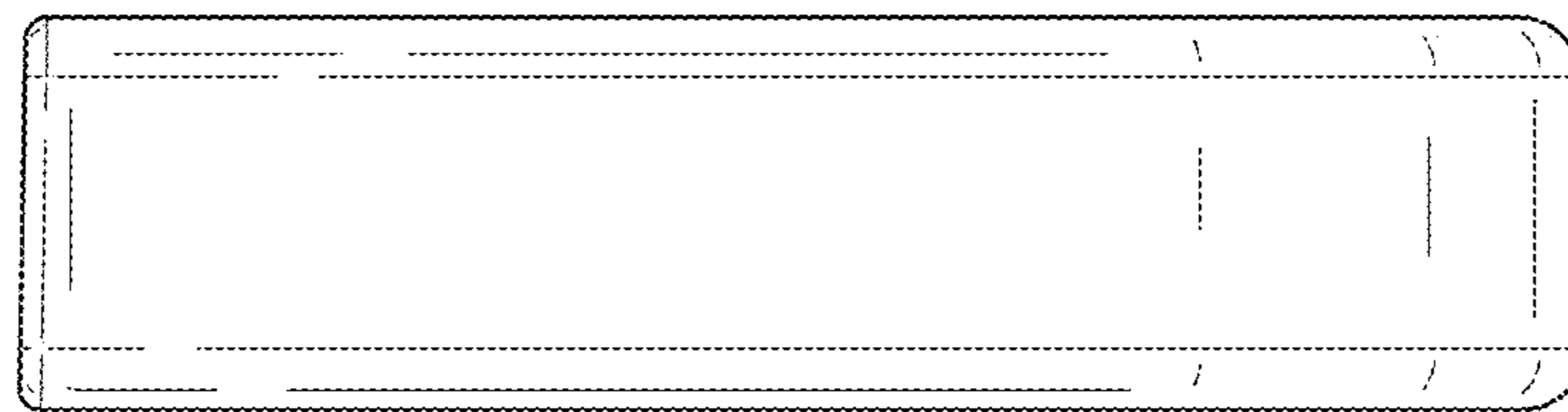

FIG. 19

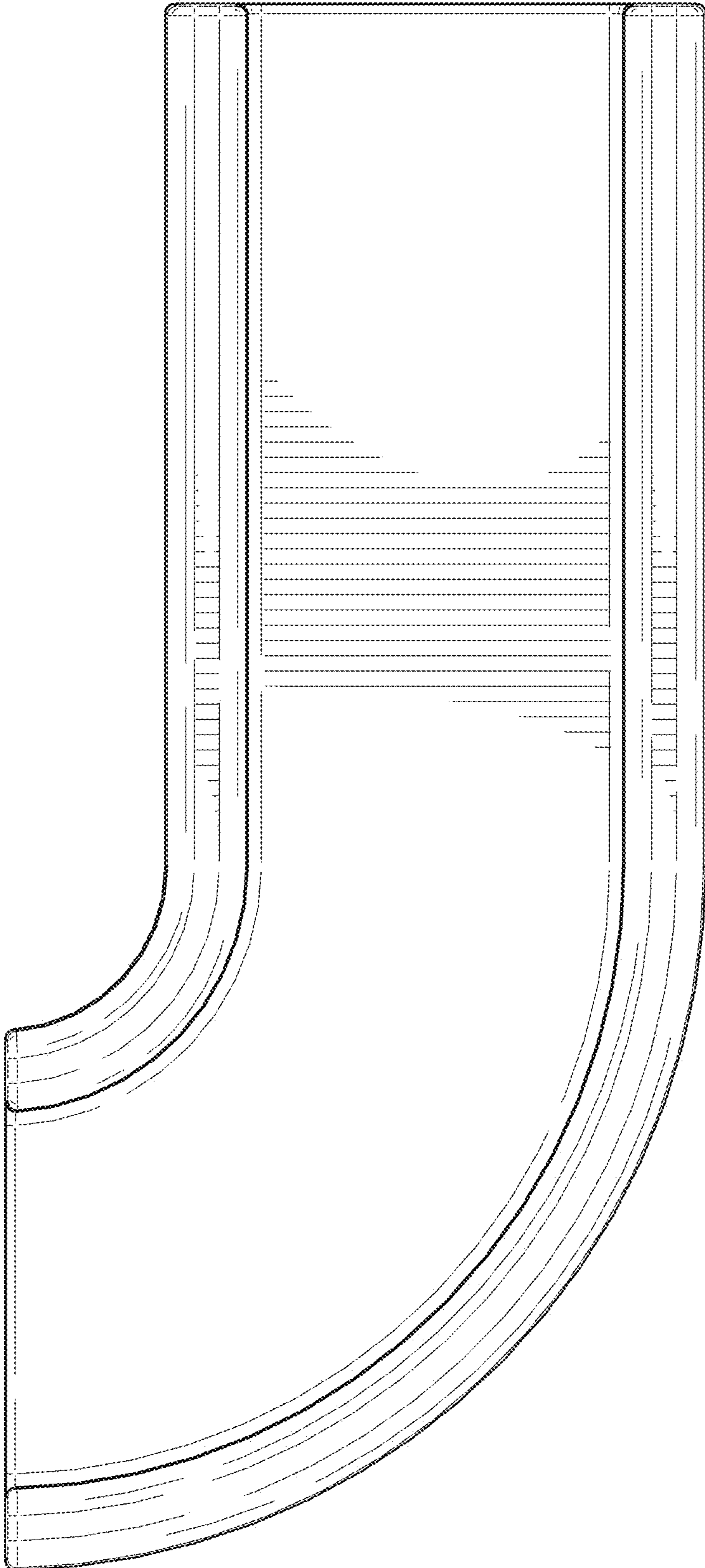

FIG. 20

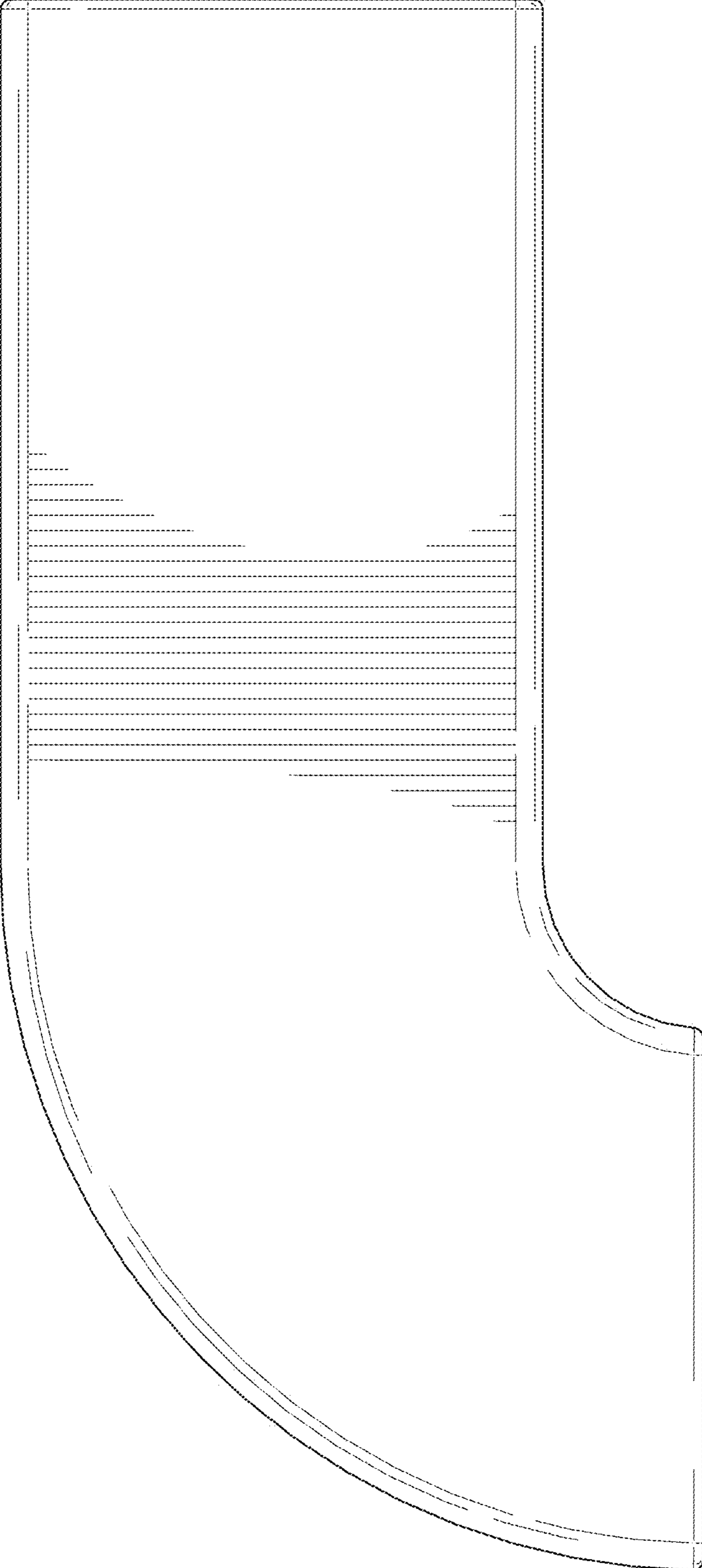

FIG. 21

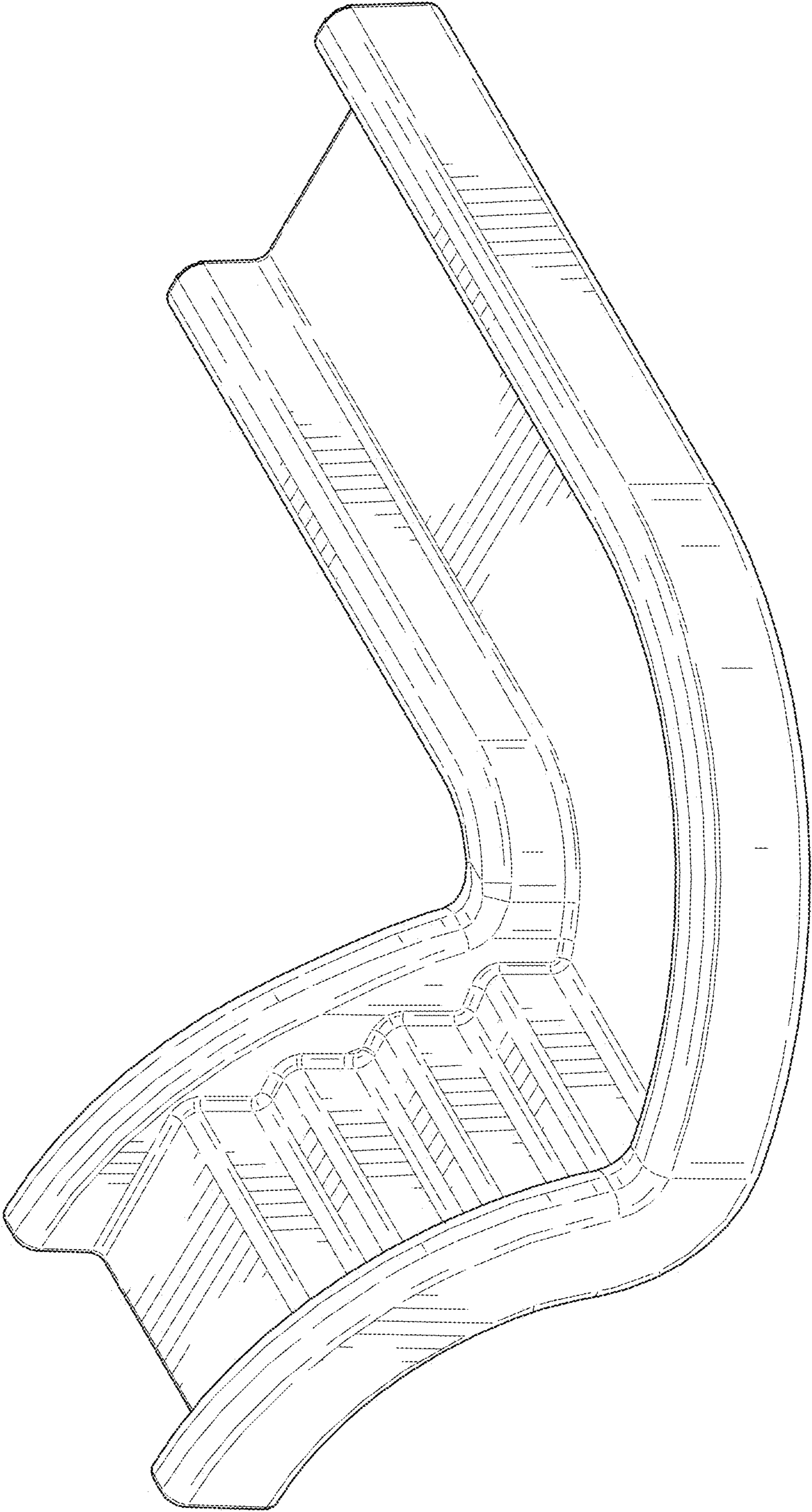

FIG. 22

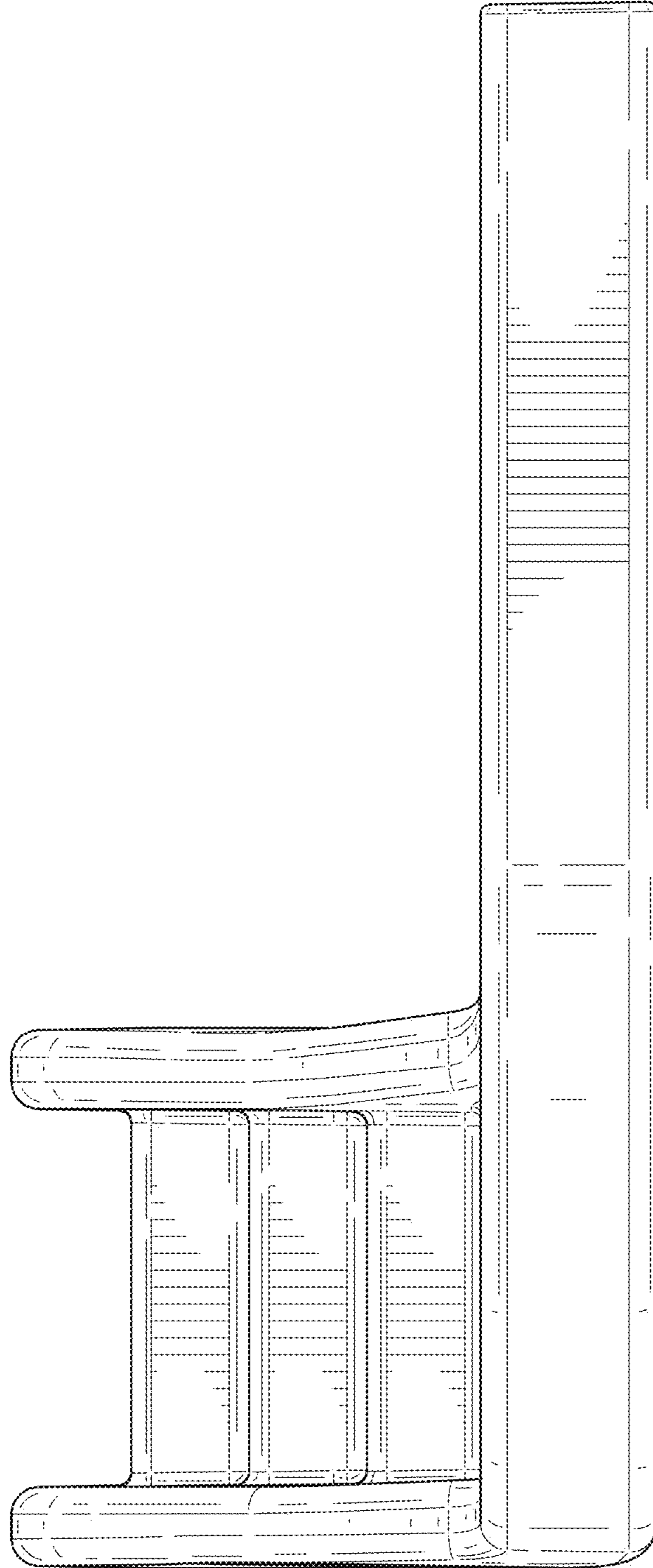

FIG. 23

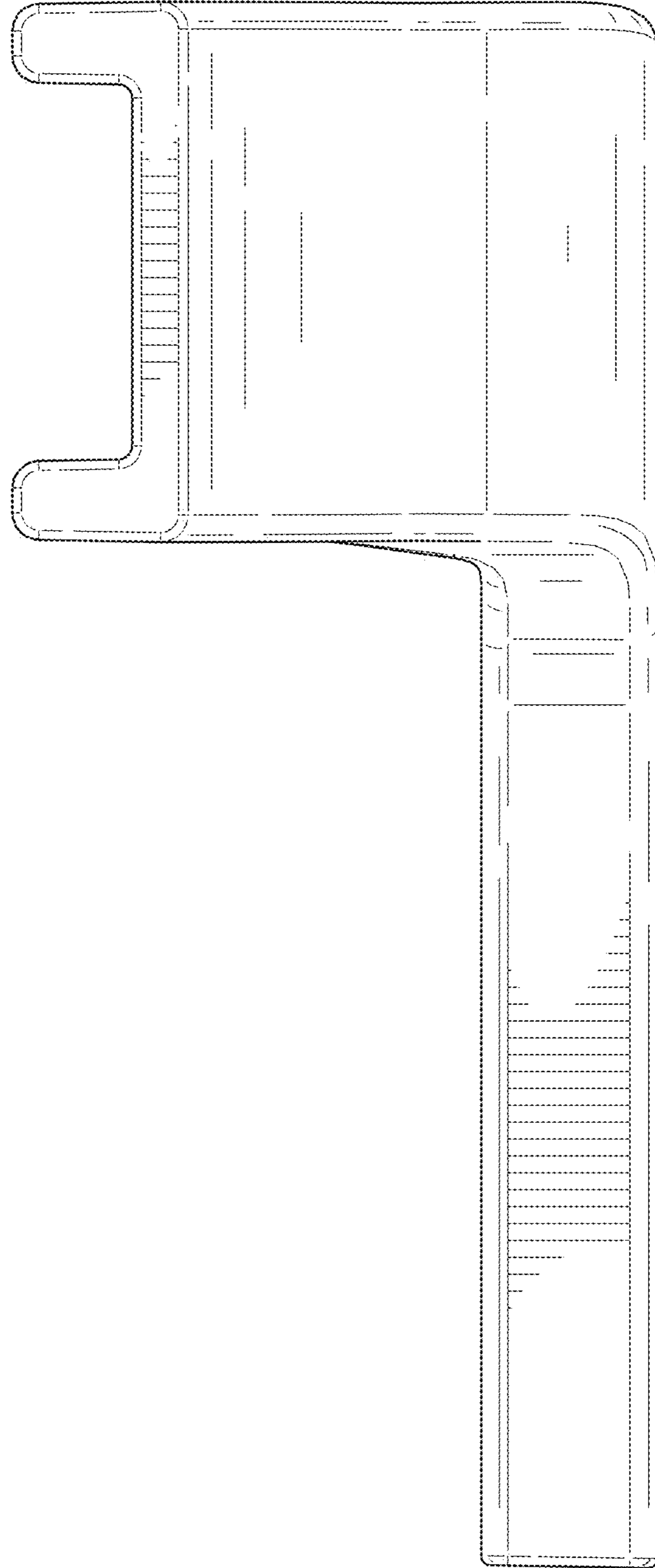

FIG. 24

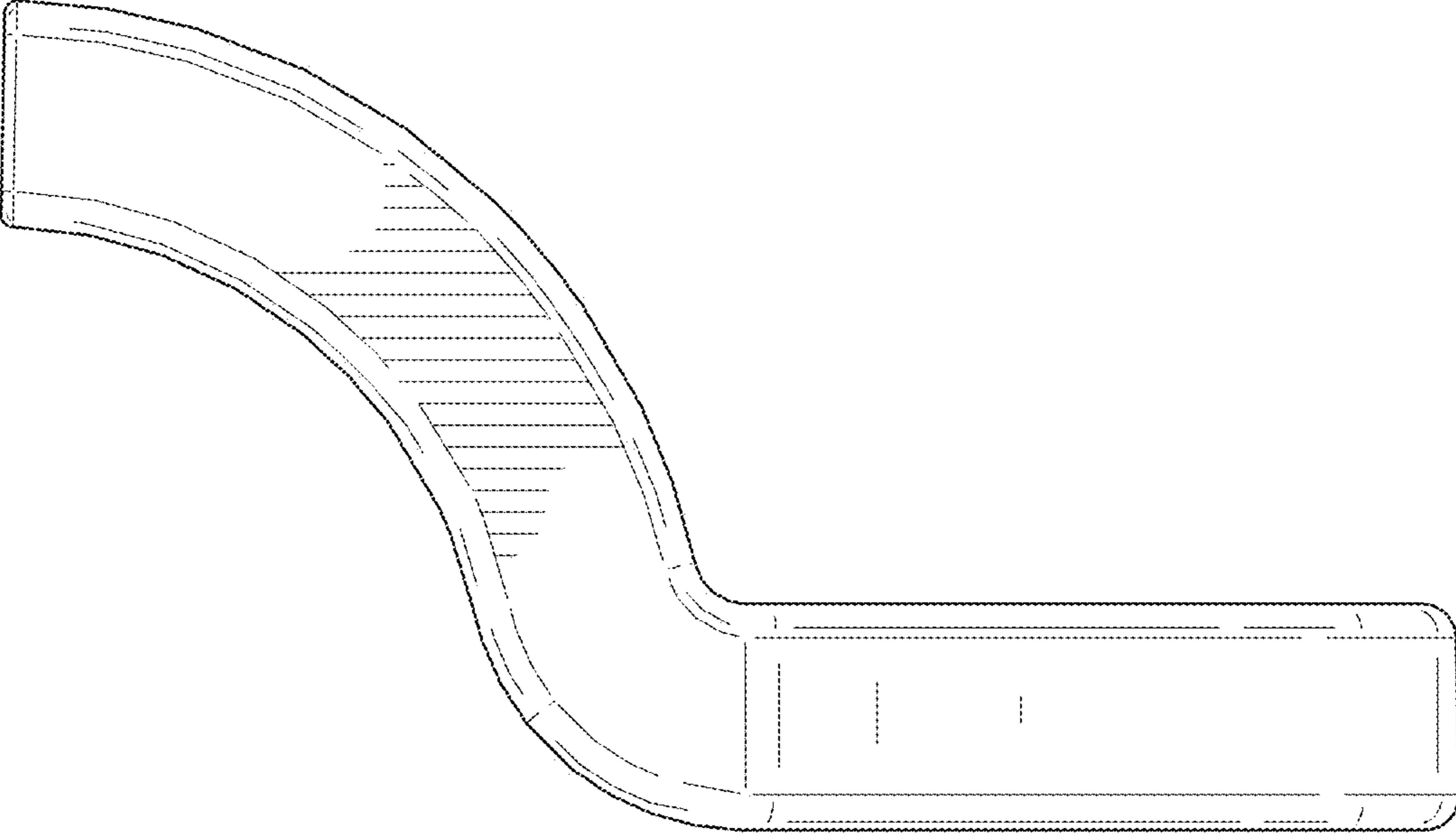

FIG. 25

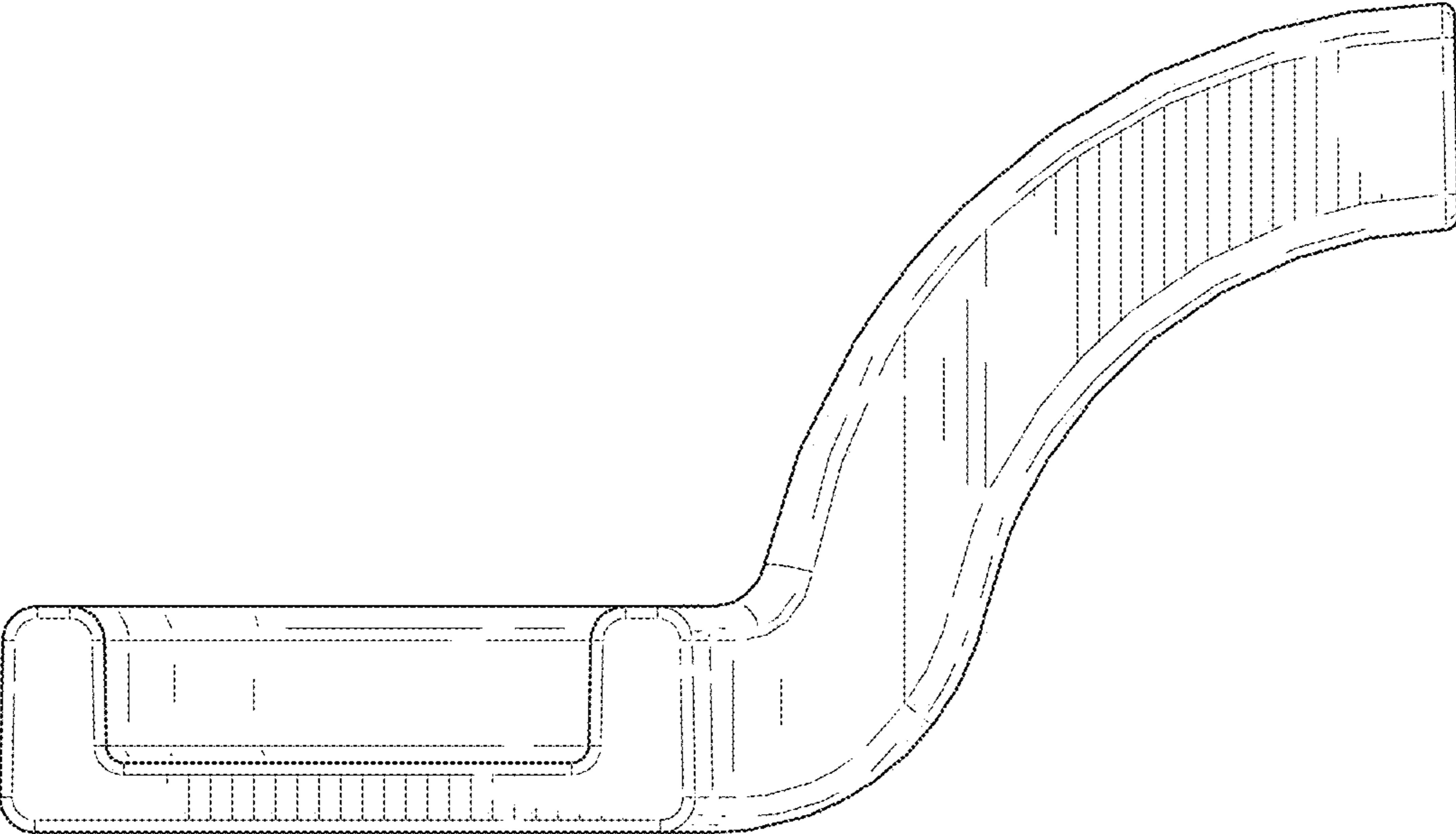

FIG. 26

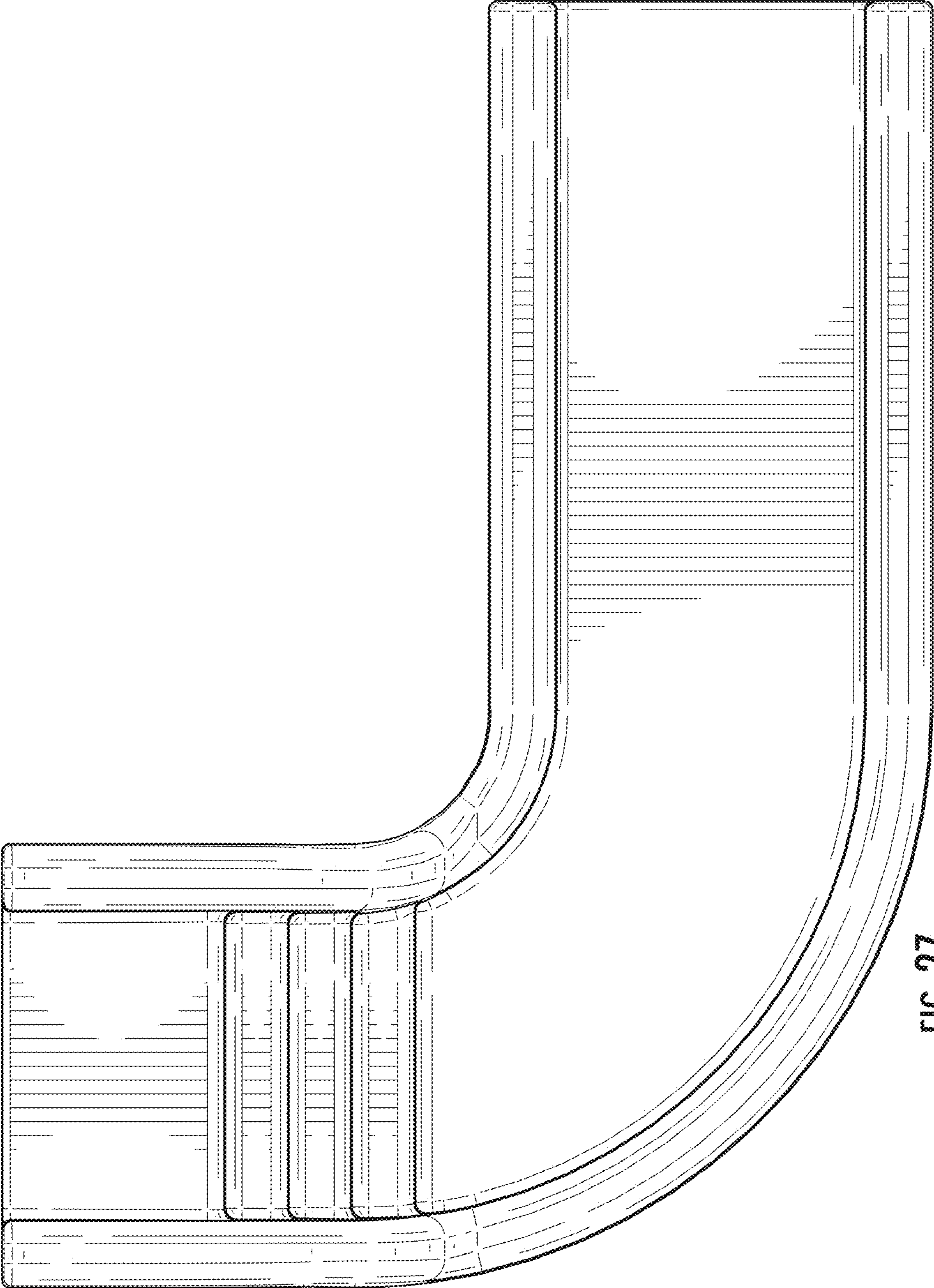

FIG. 27



FIG. 28

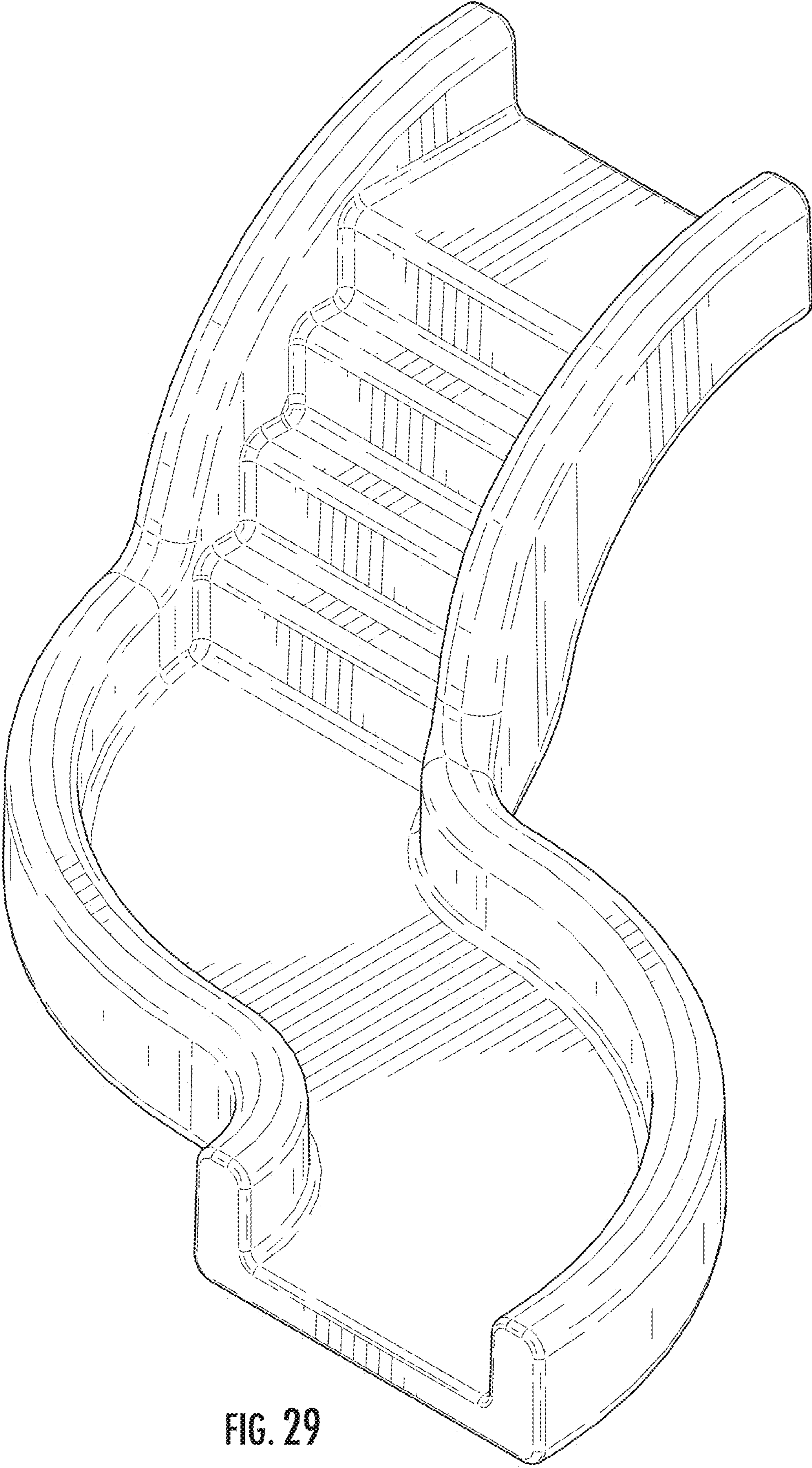

FIG. 29

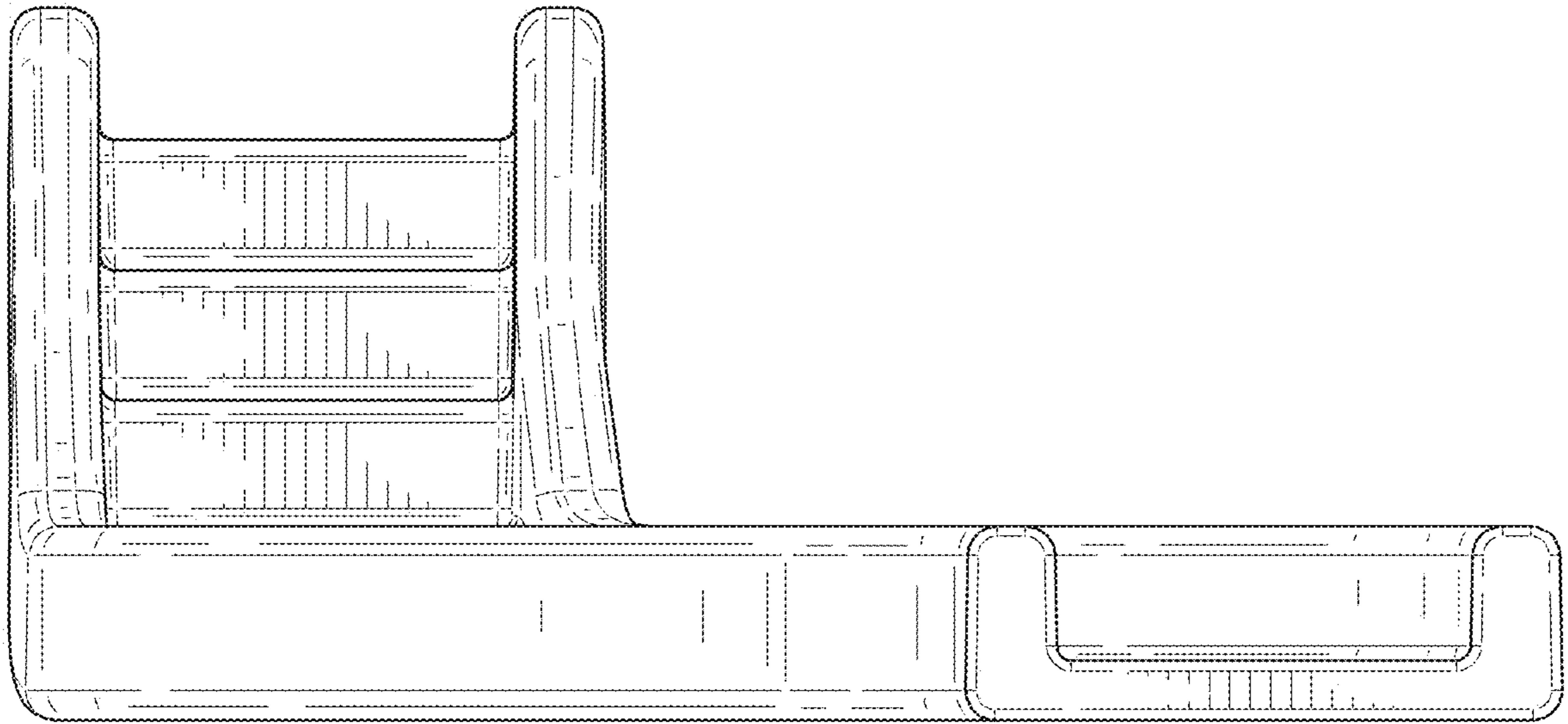

FIG. 30

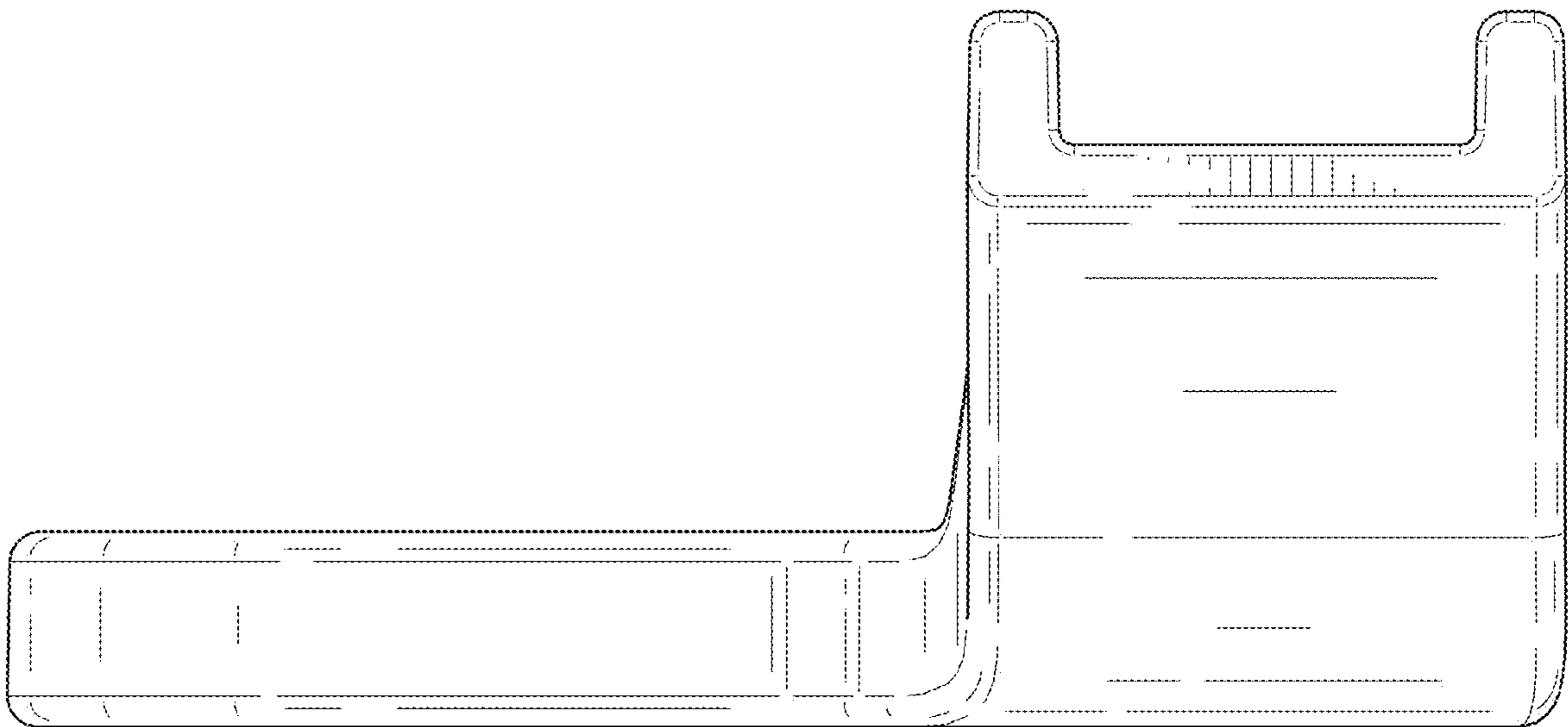

FIG. 31

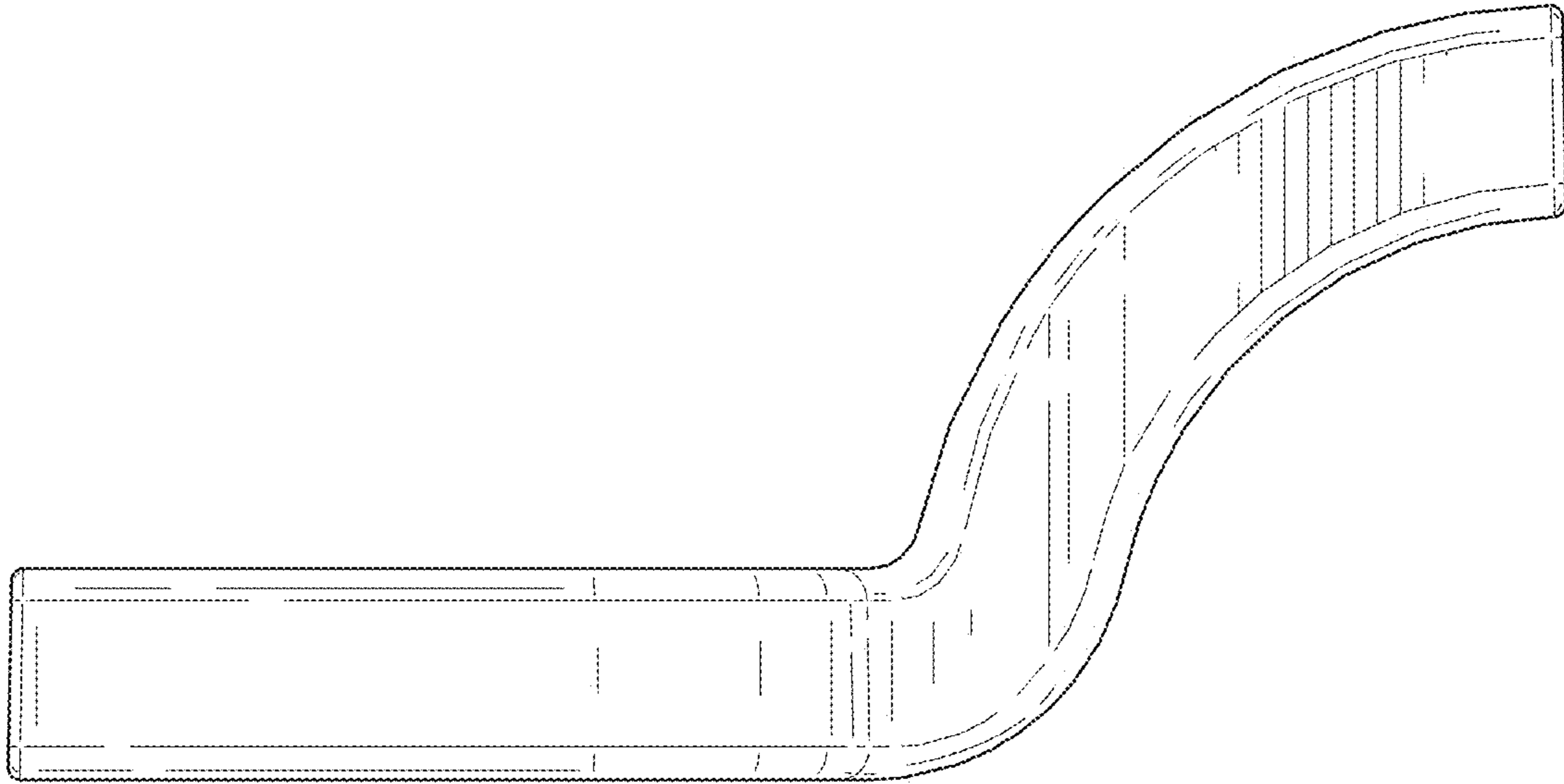

FIG. 32

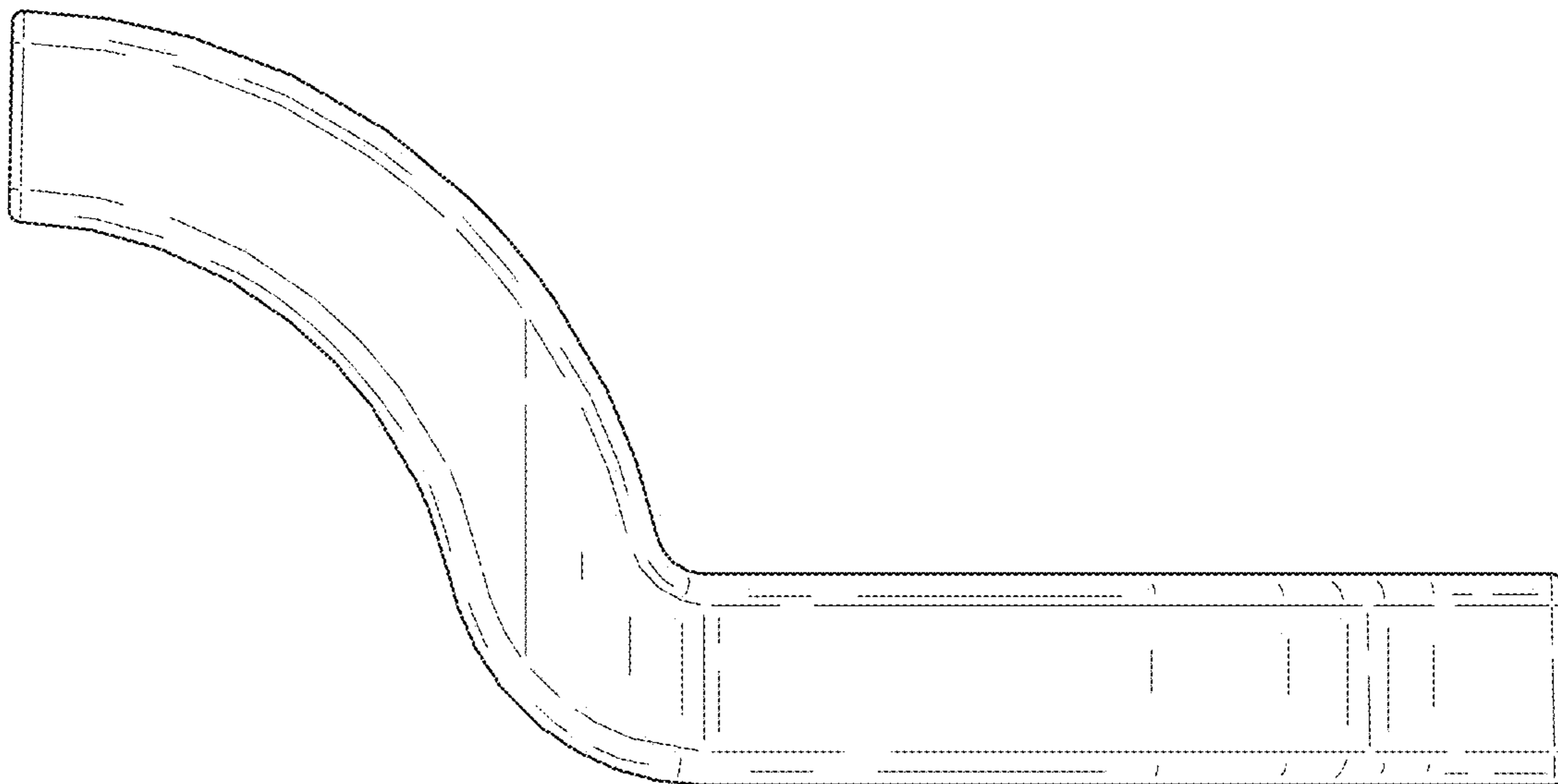

FIG. 33

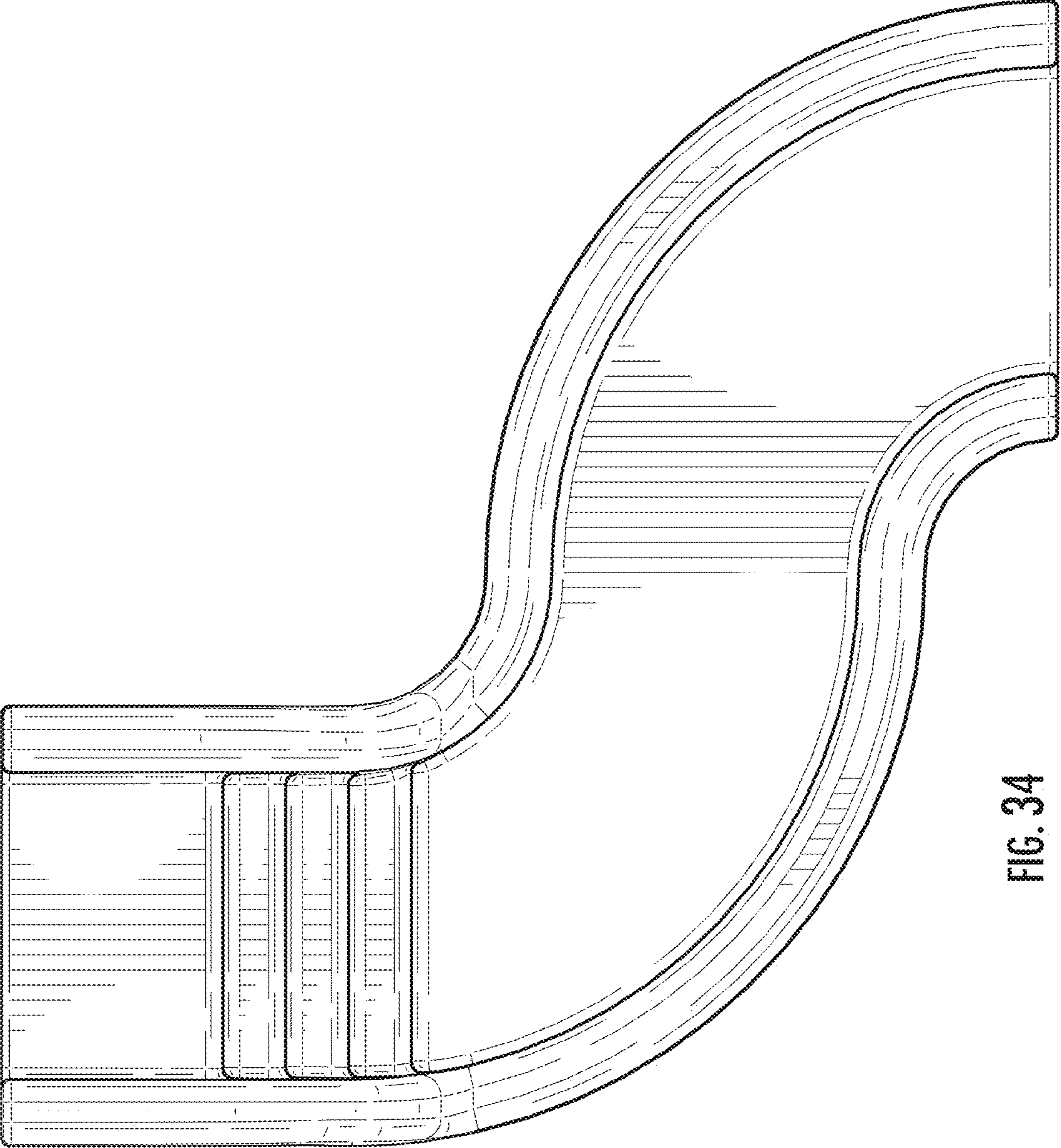

FIG. 34

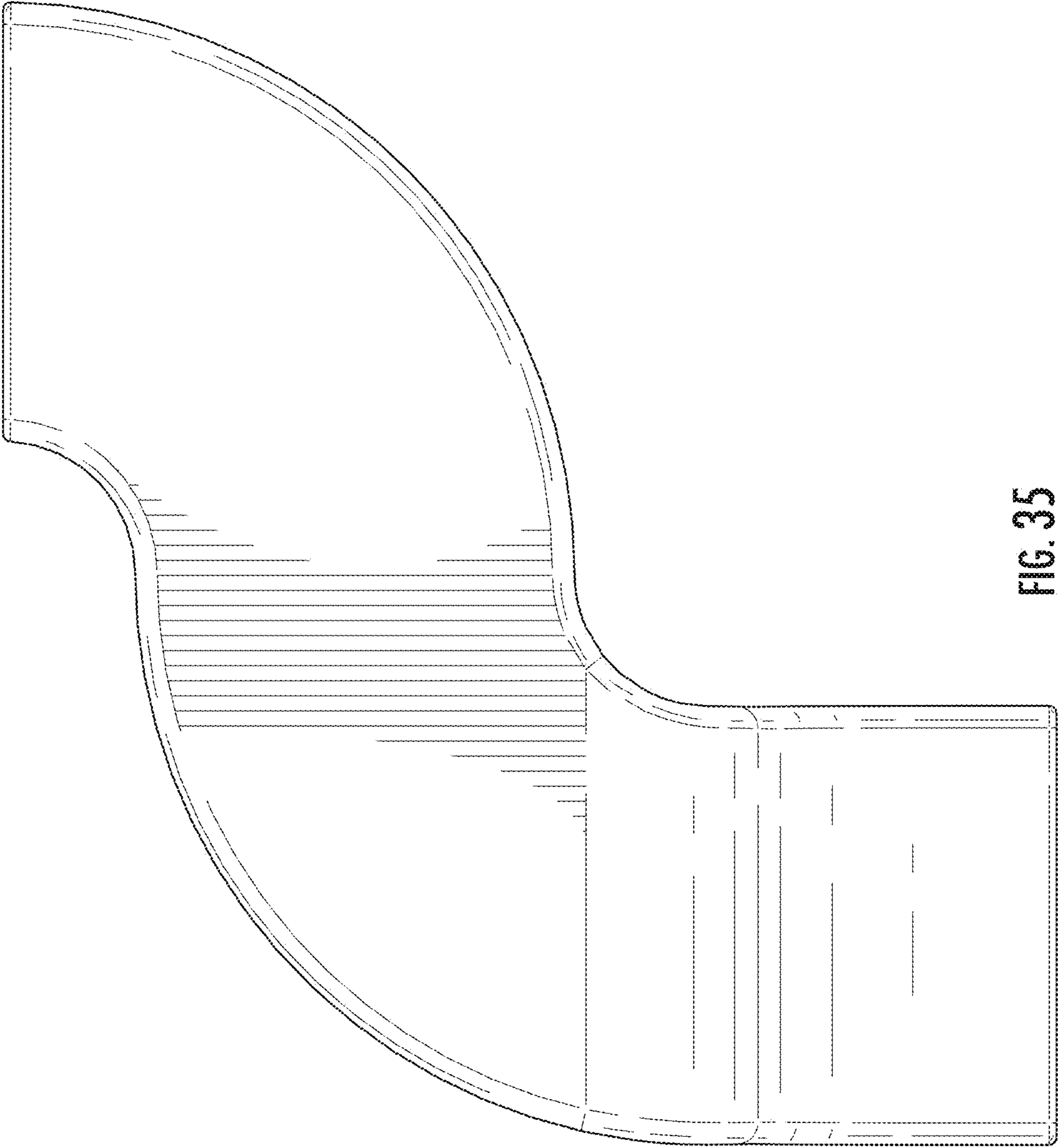

FIG. 35

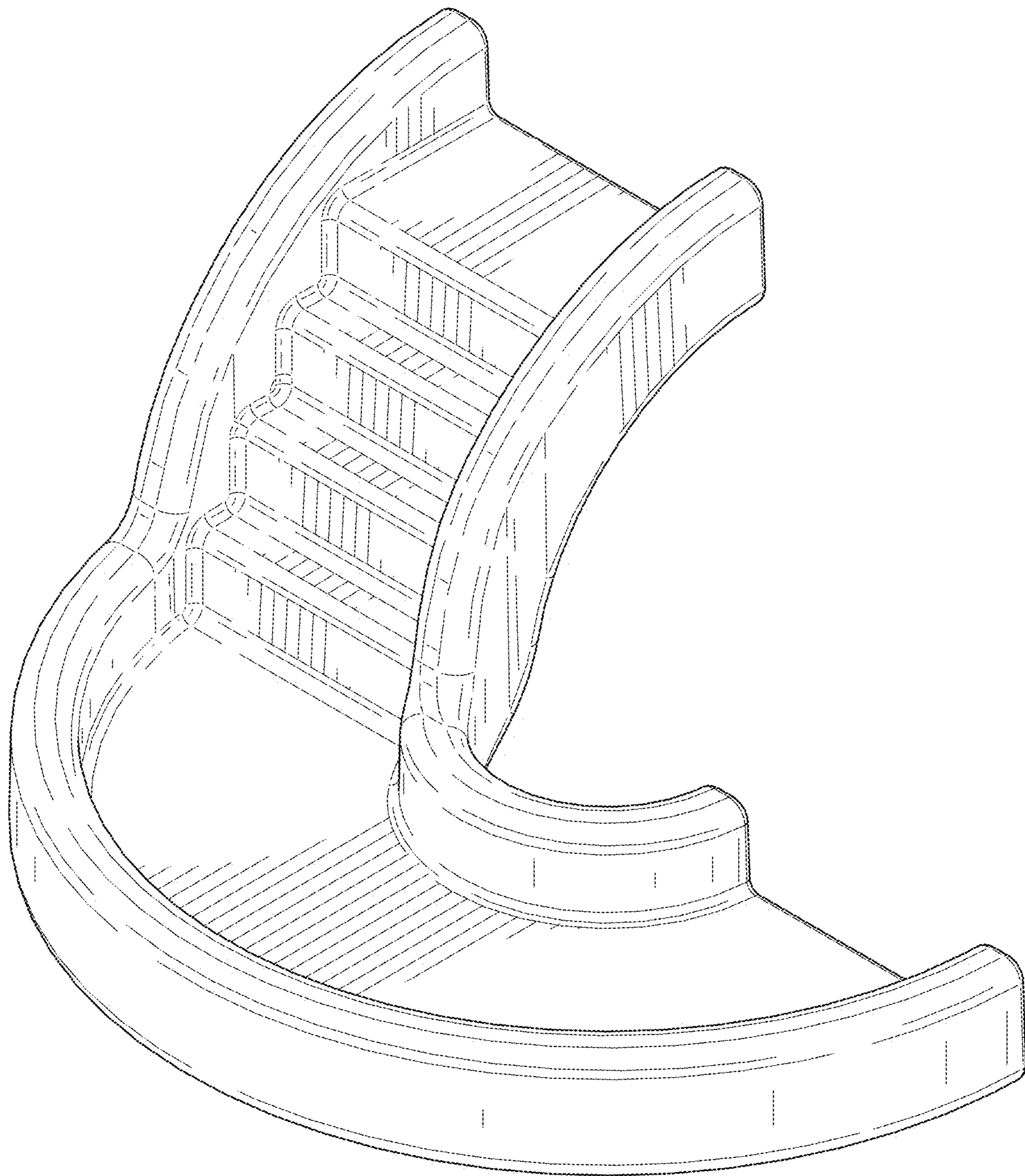

FIG. 36

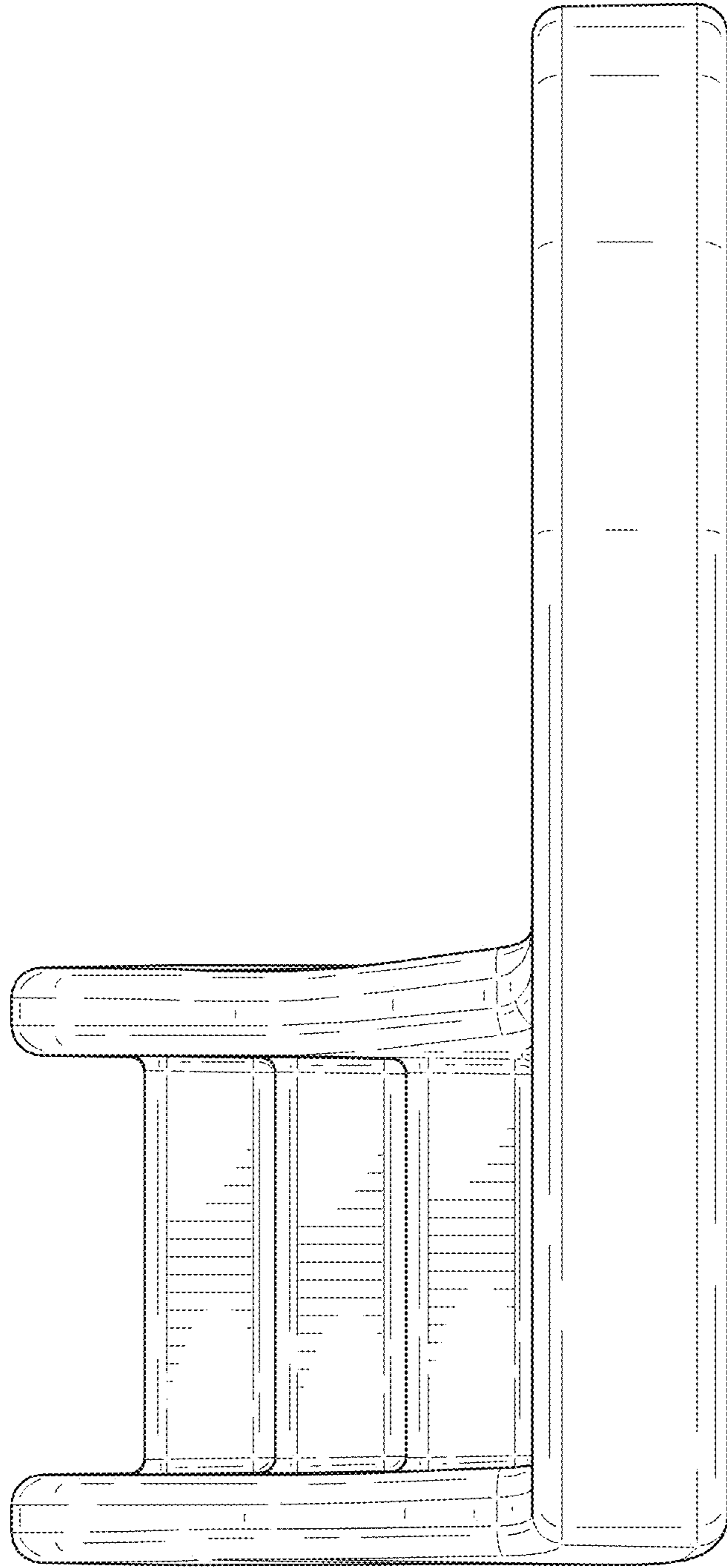

FIG. 37

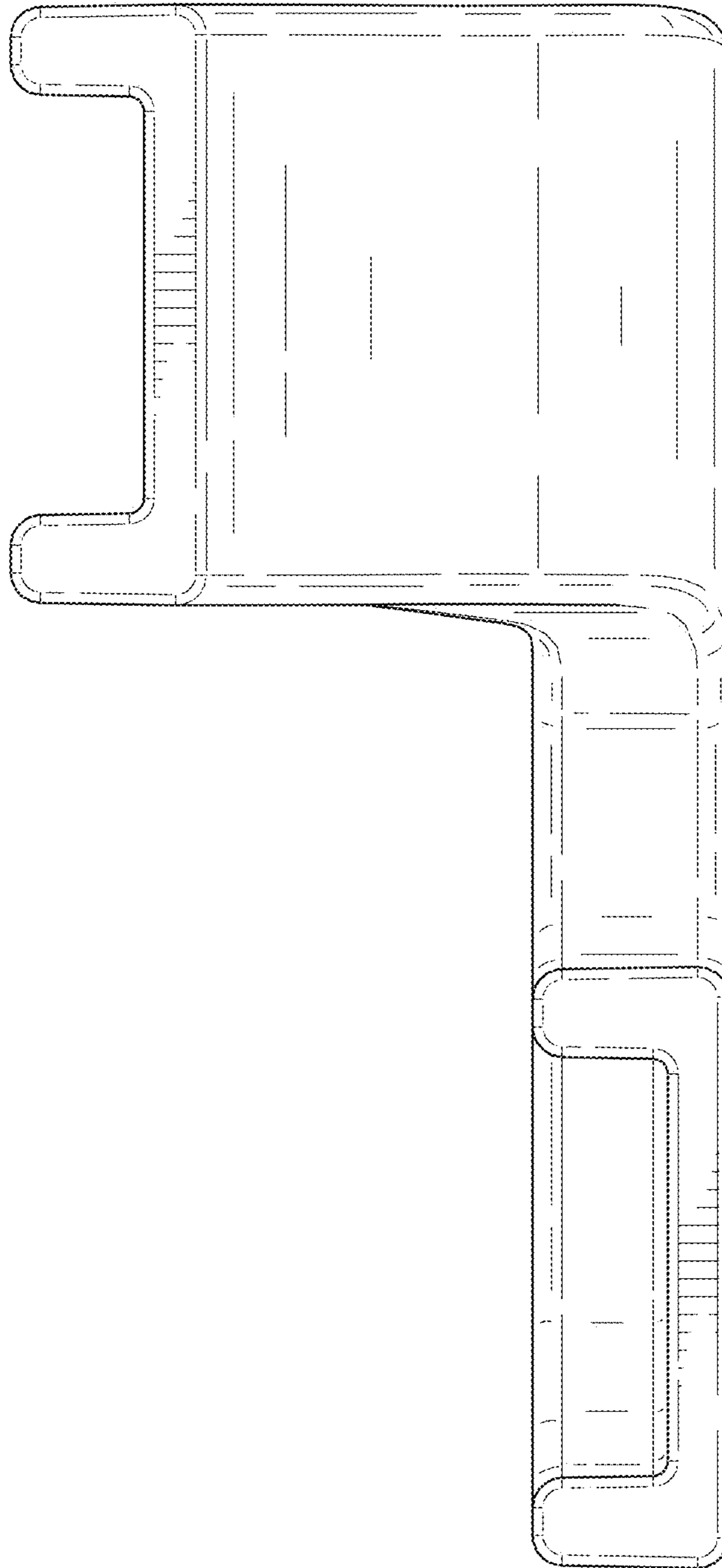

FIG. 38

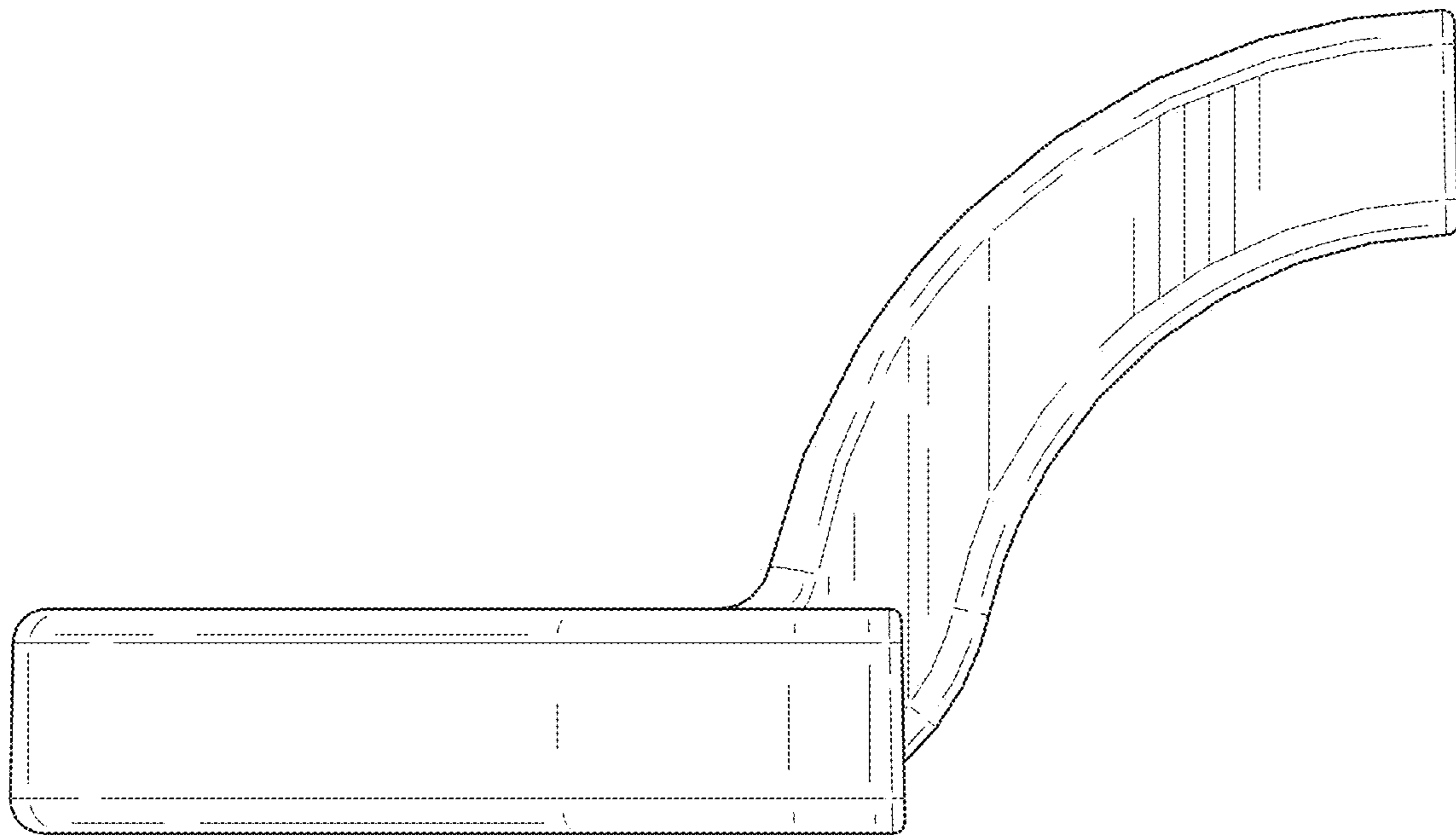

FIG. 39

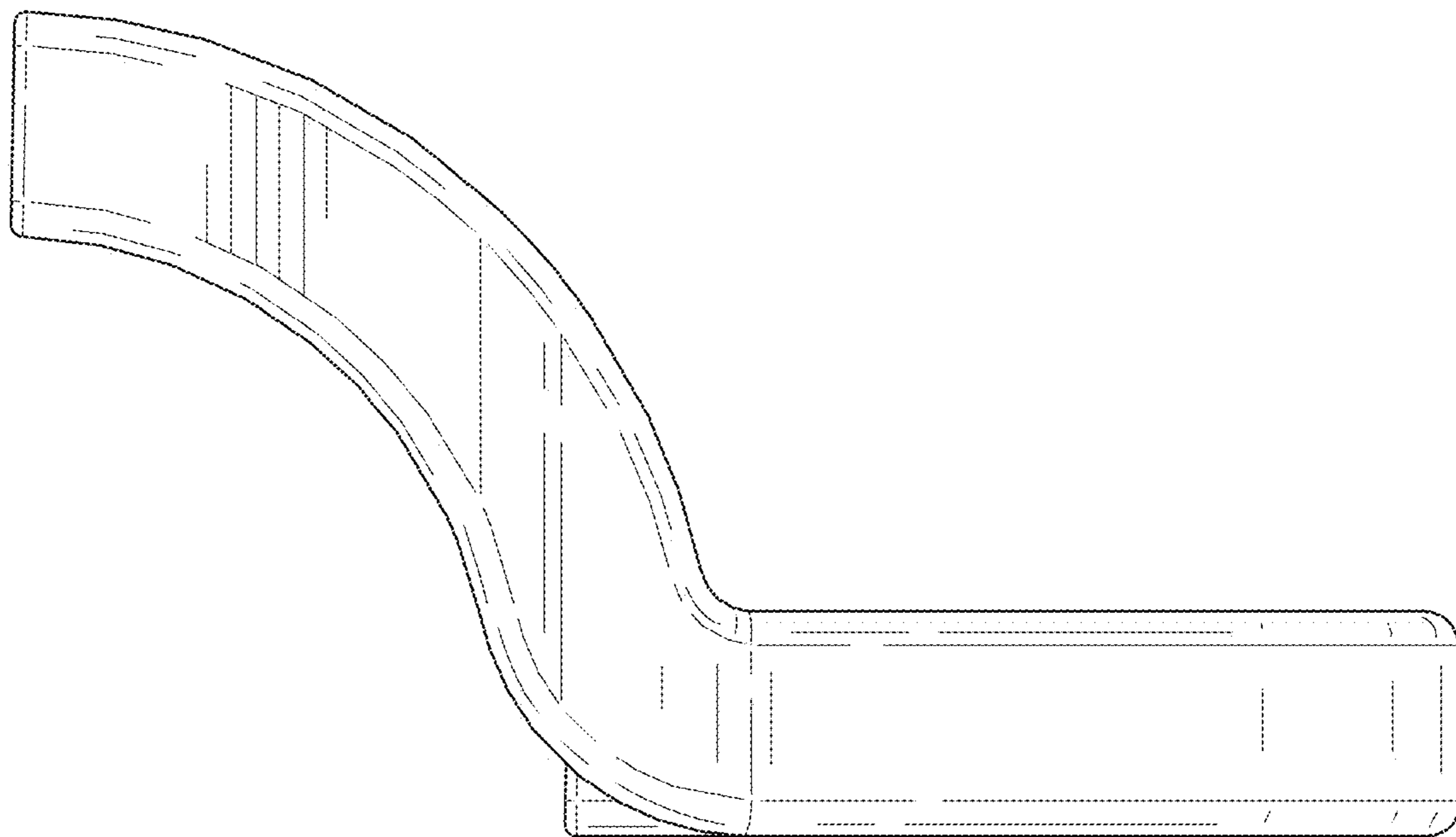

FIG. 40

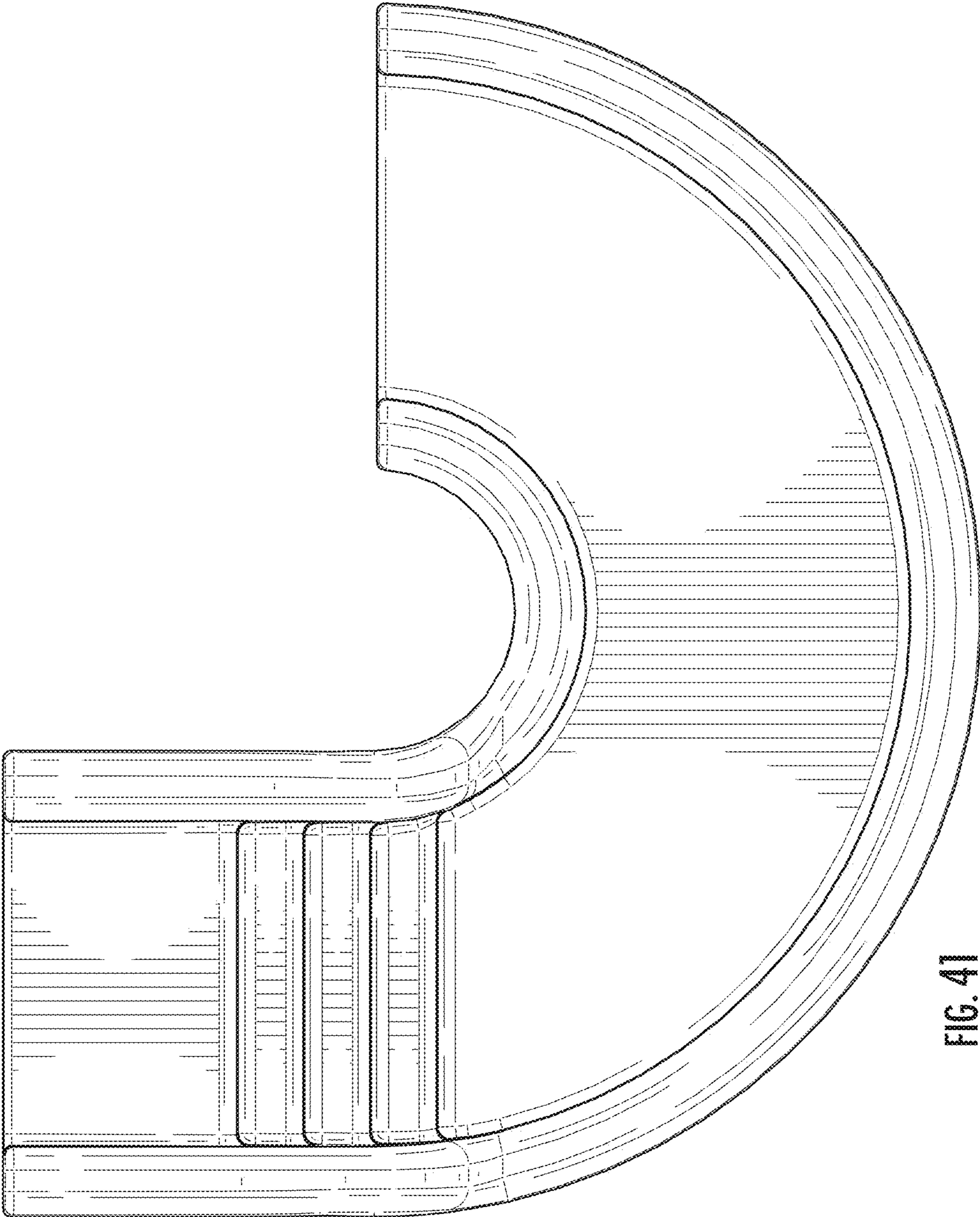

FIG. 41



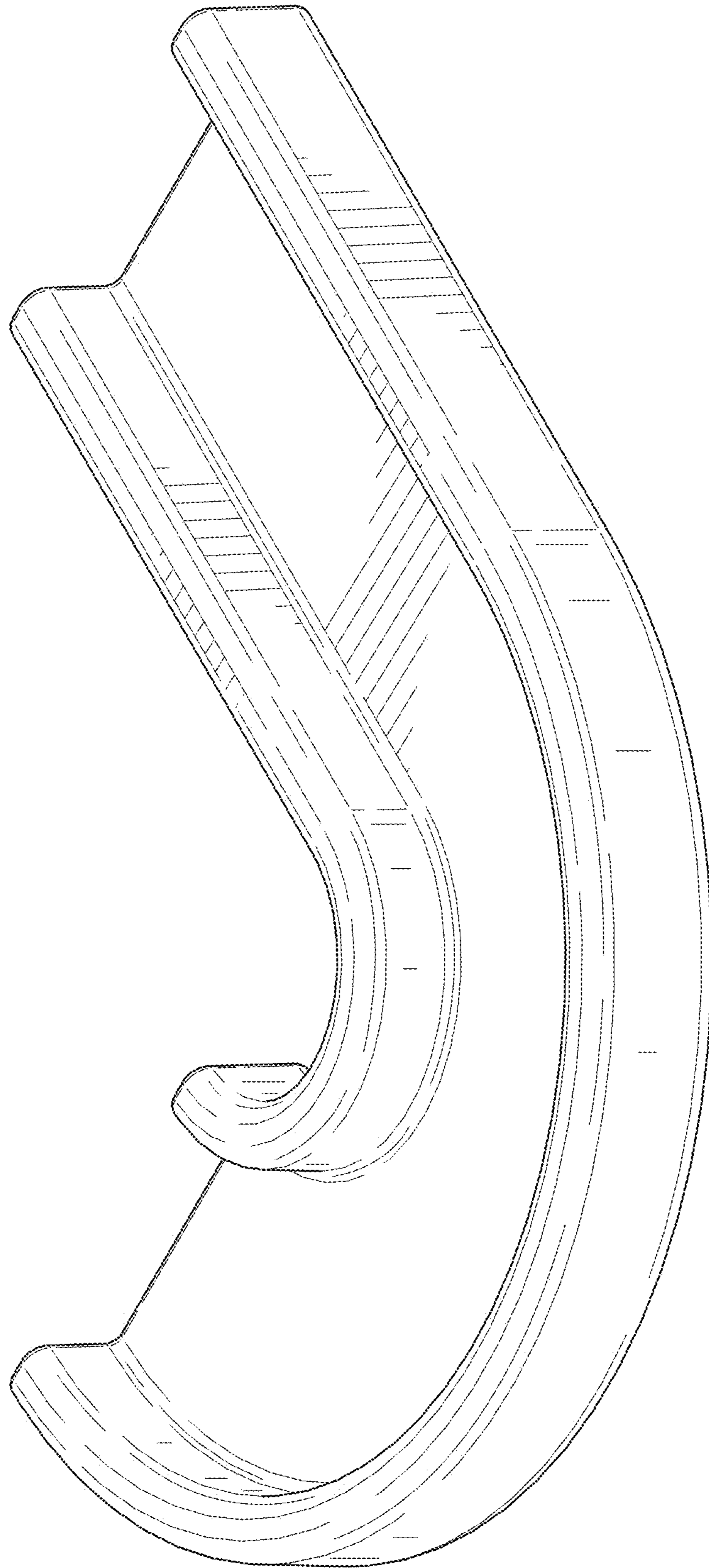

FIG. 43

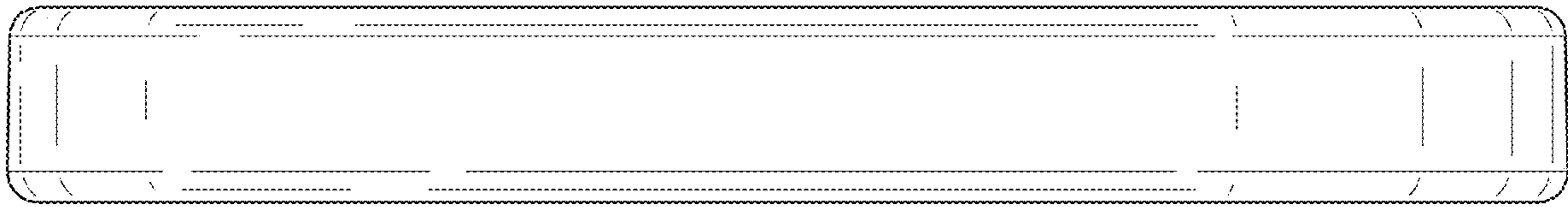

FIG. 44

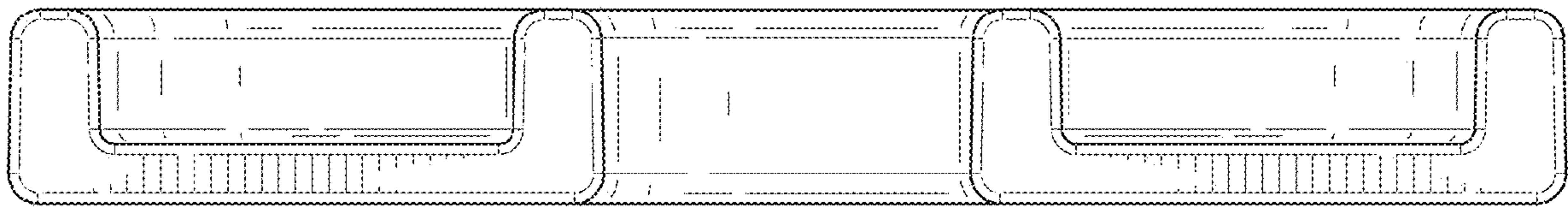

FIG. 45

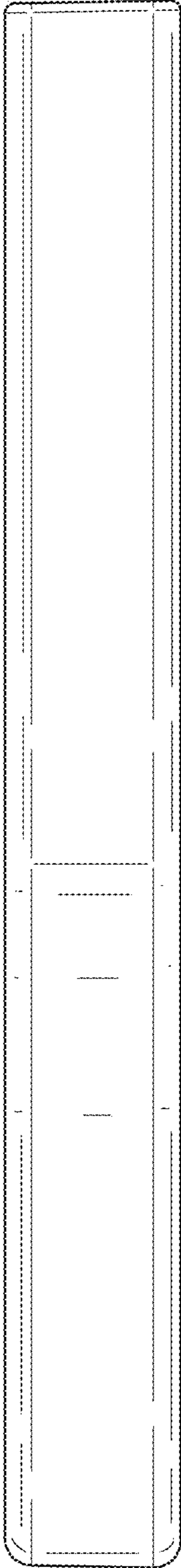

FIG. 46

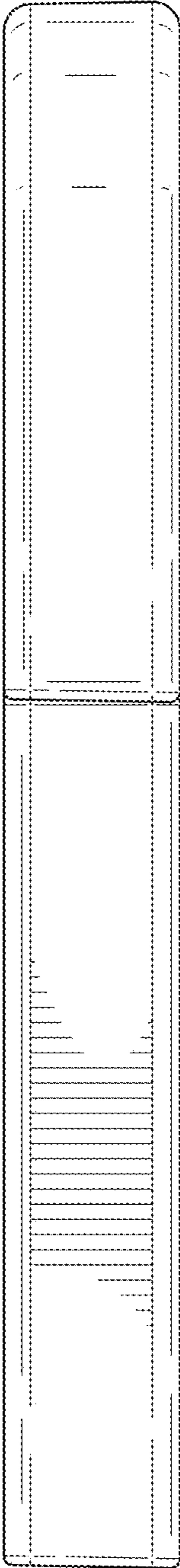

FIG. 47

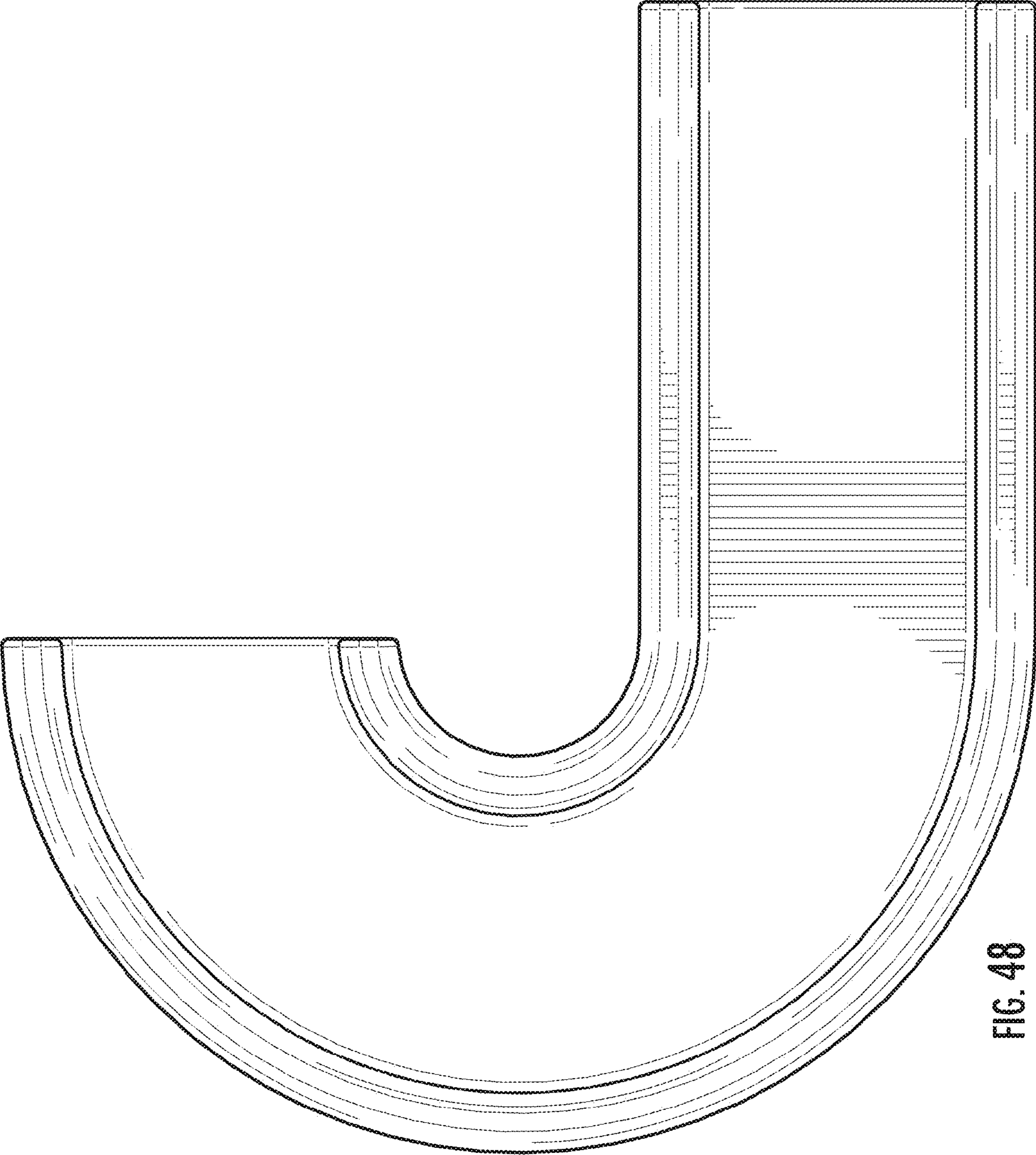

FIG. 48

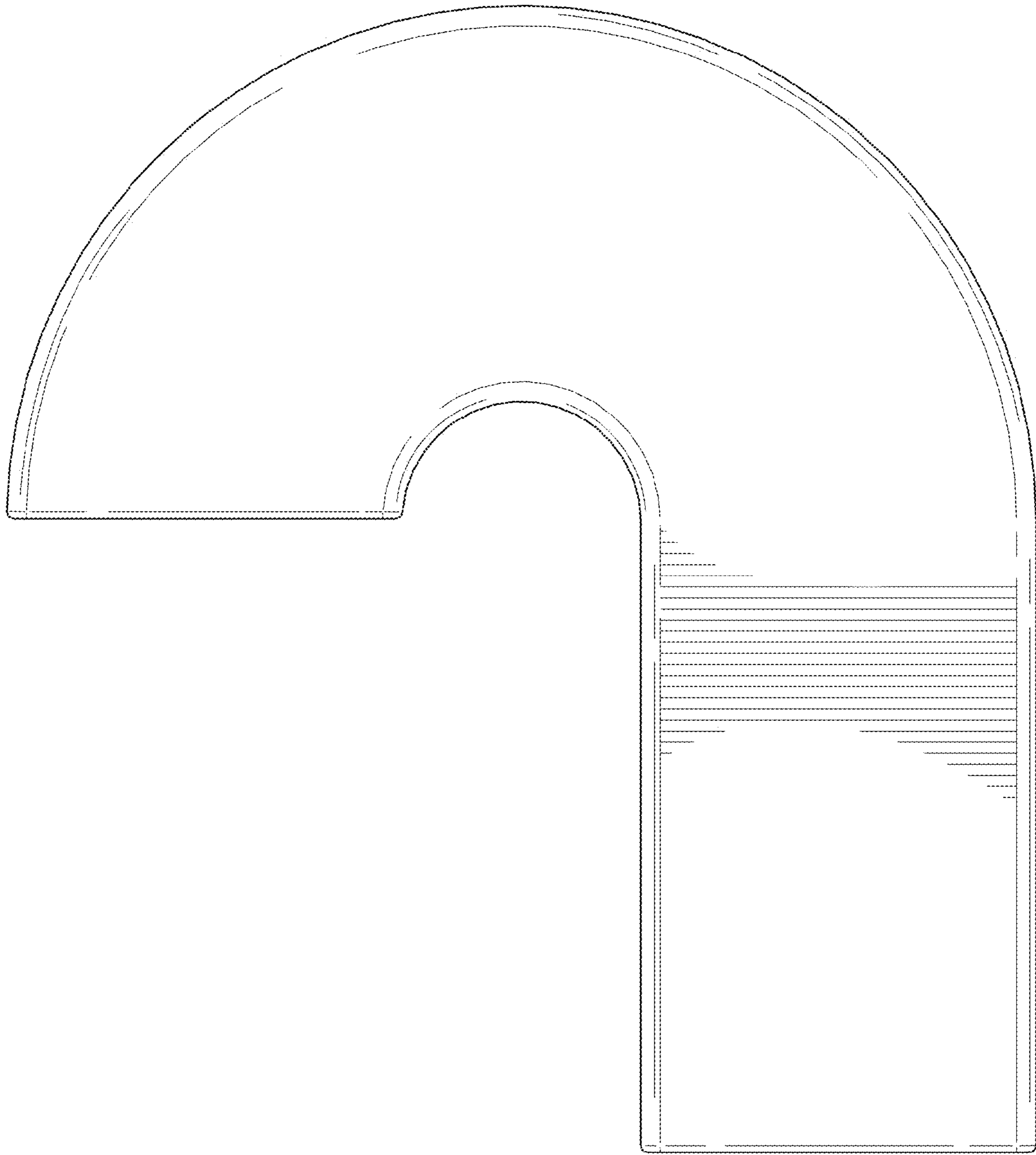

FIG. 49

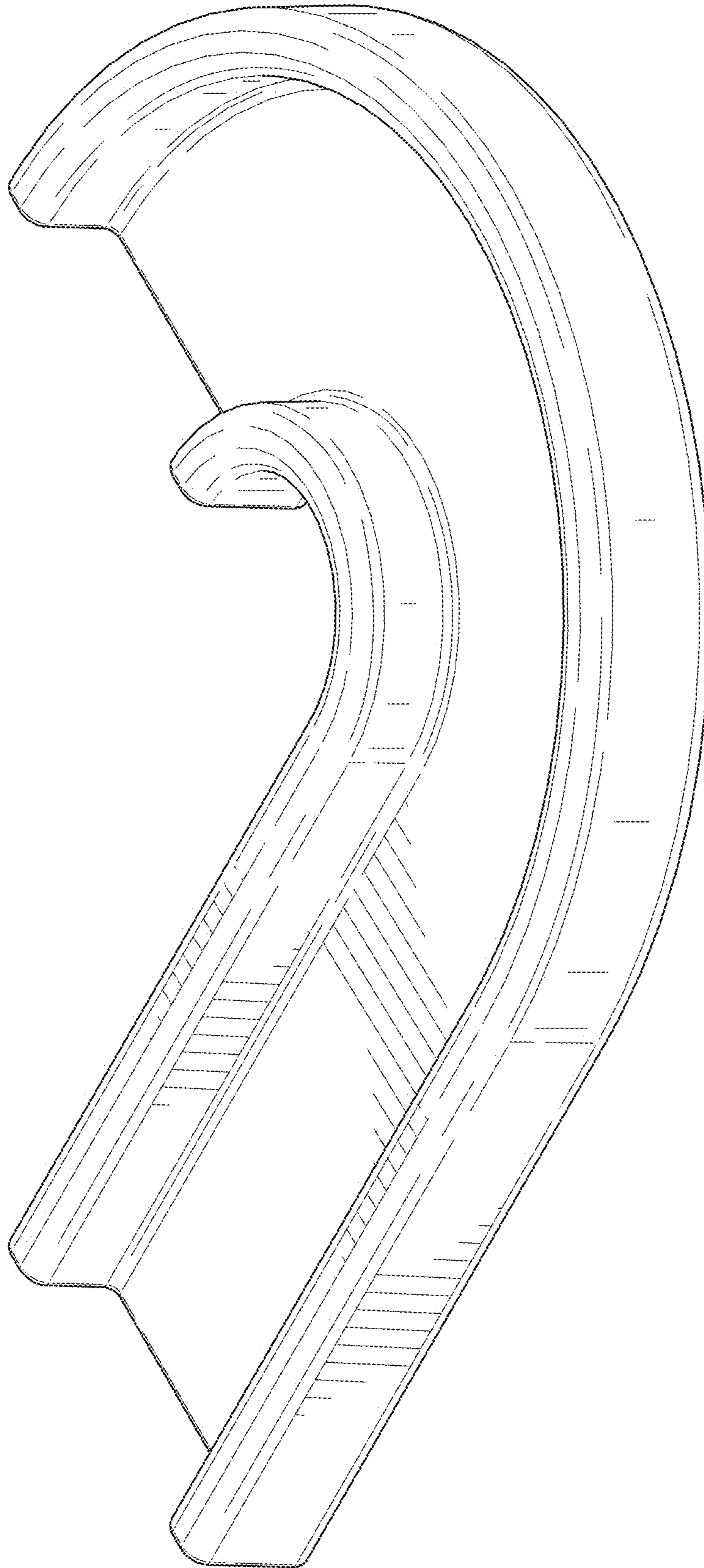

FIG. 50

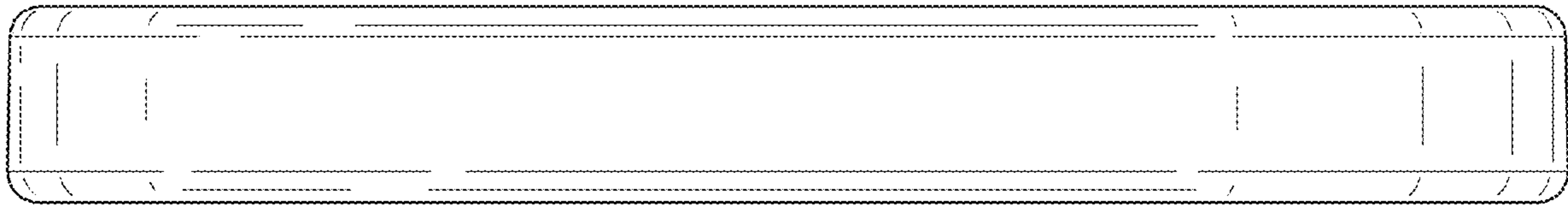

FIG. 51

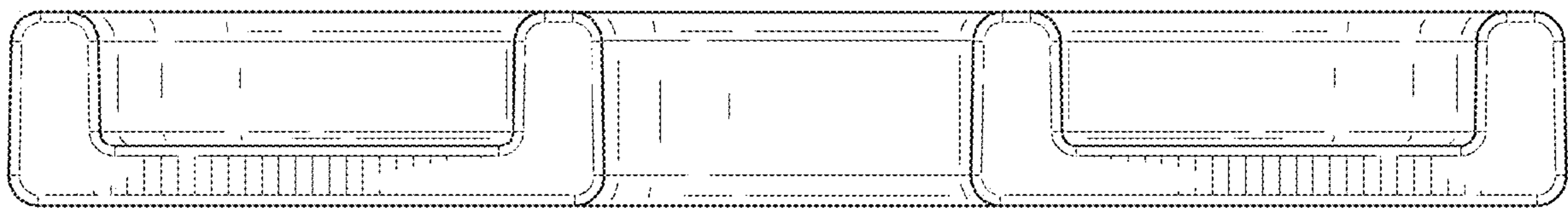

FIG. 52

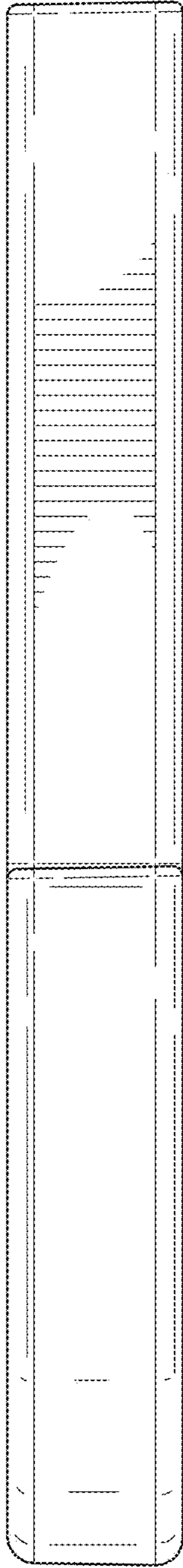

FIG. 53

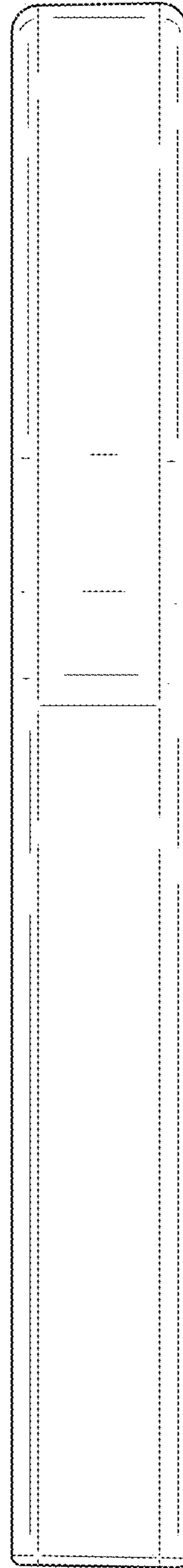

FIG. 54

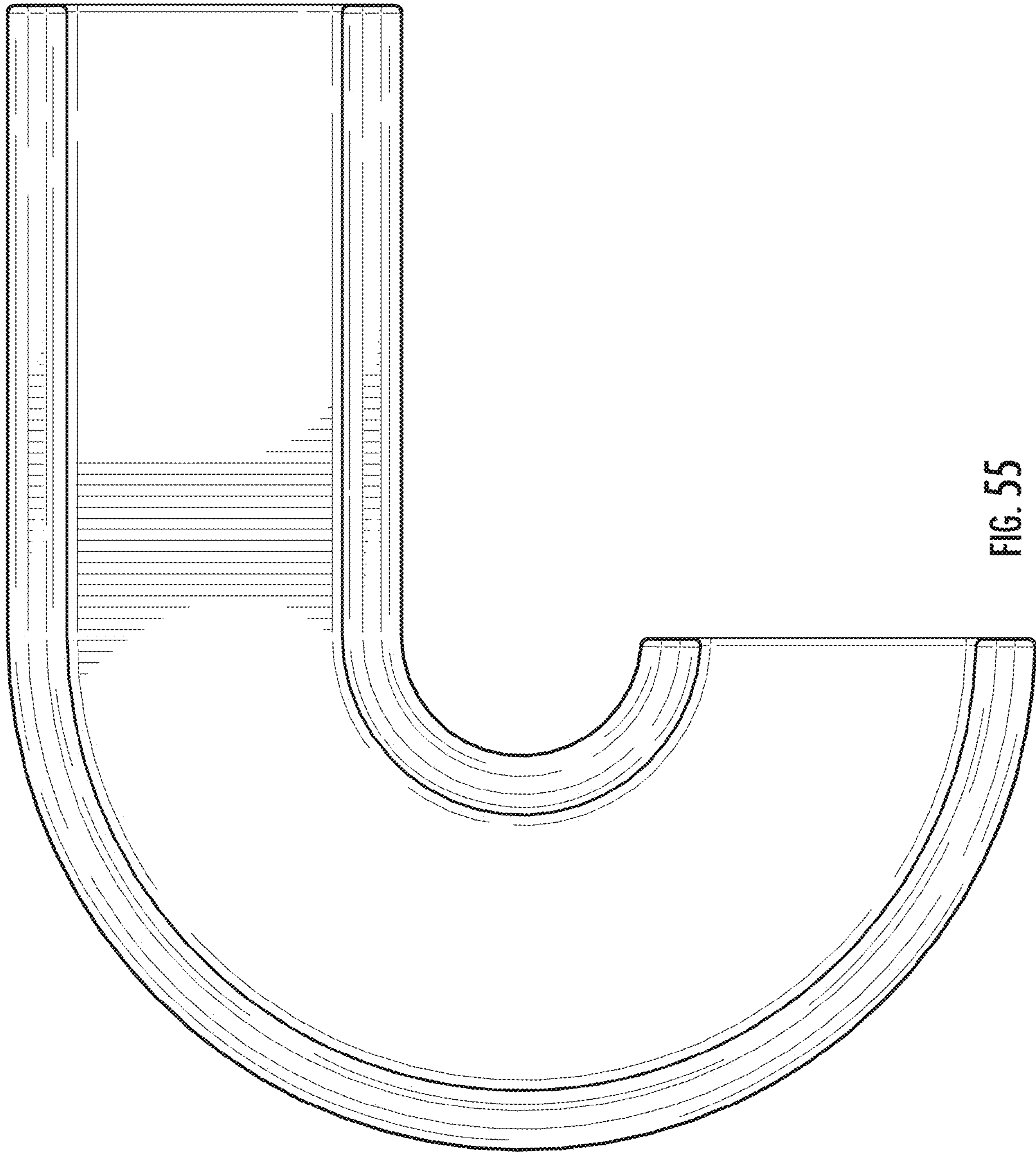

FIG. 55

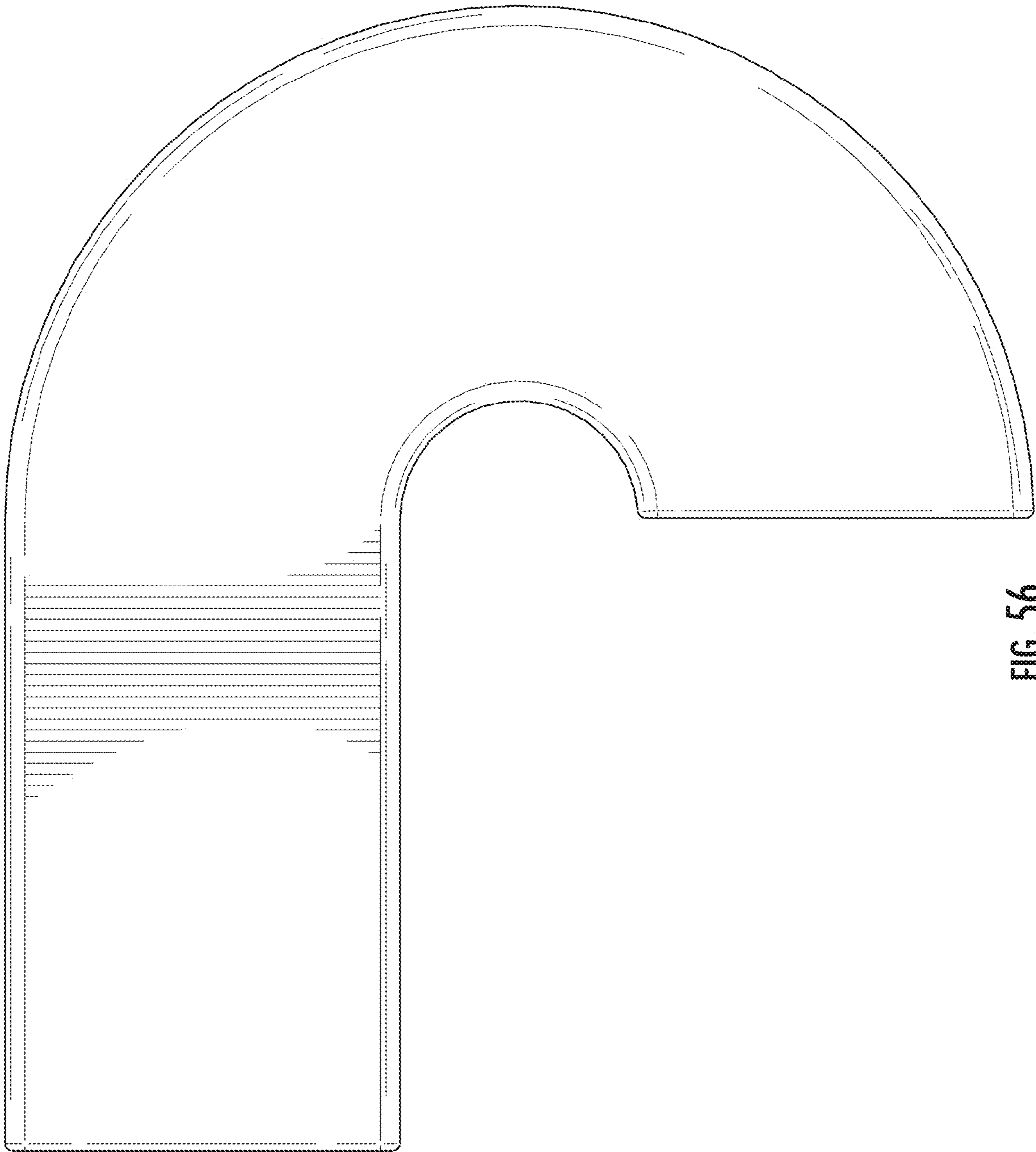

FIG. 56

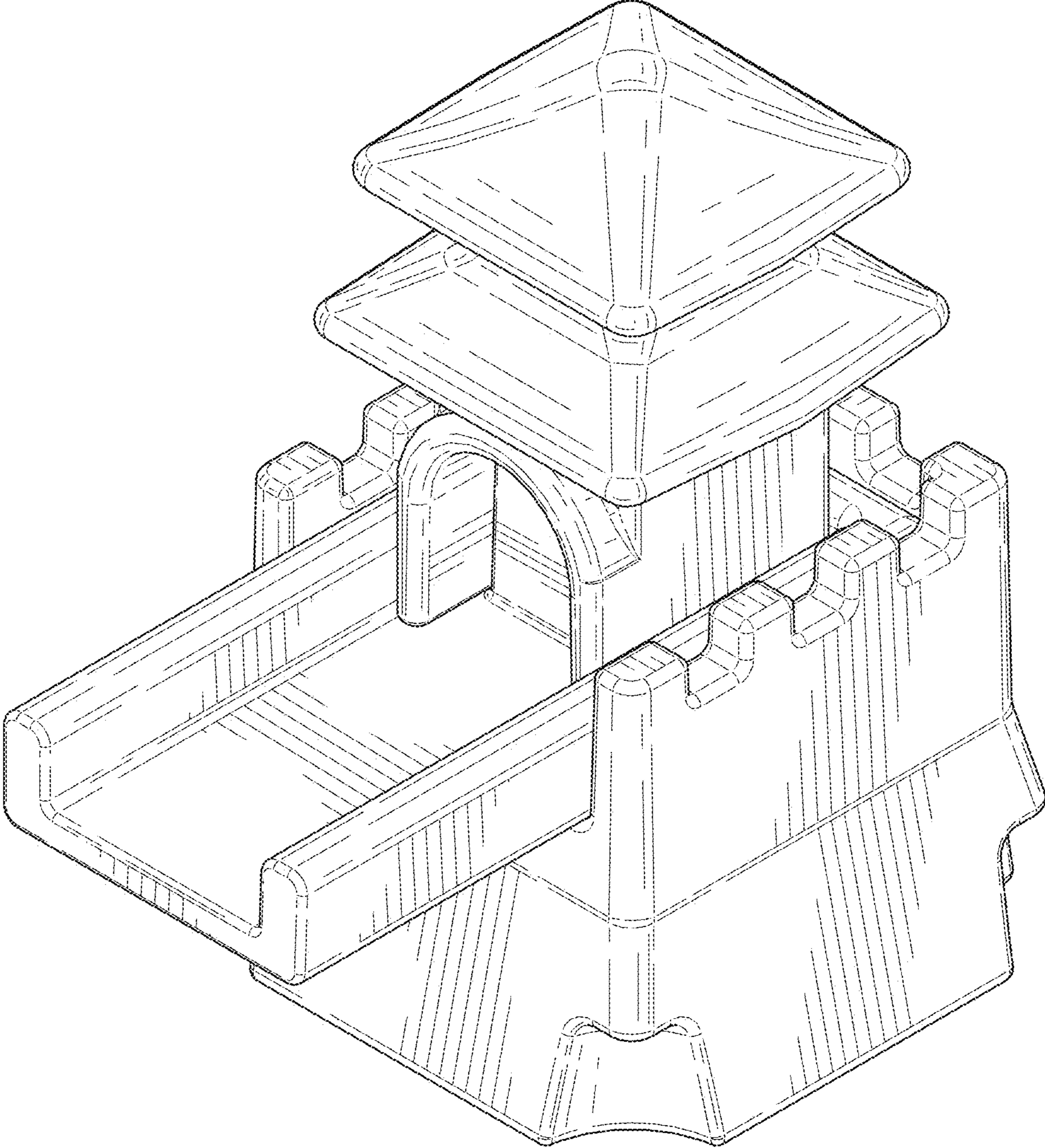

FIG. 57

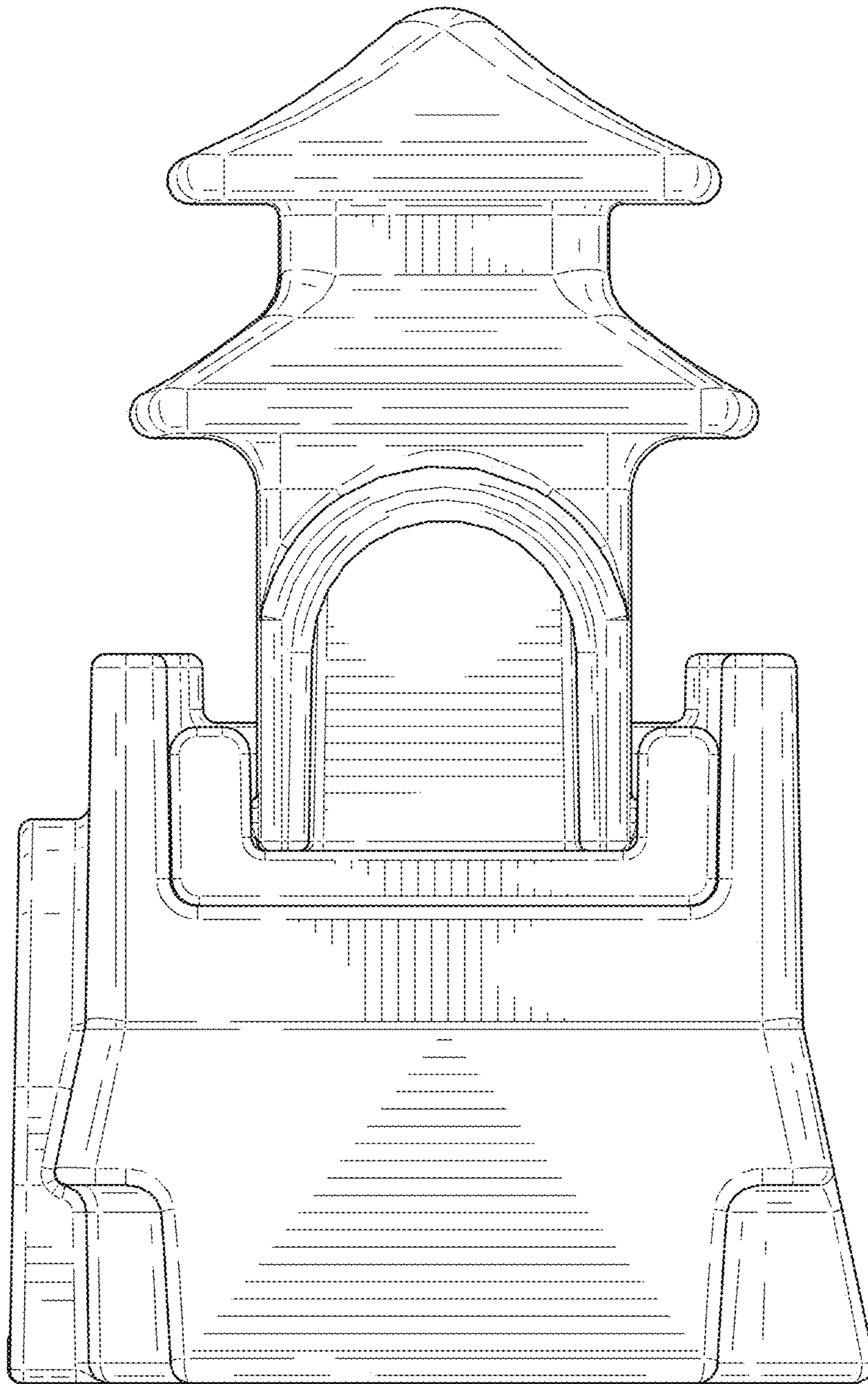

FIG. 58

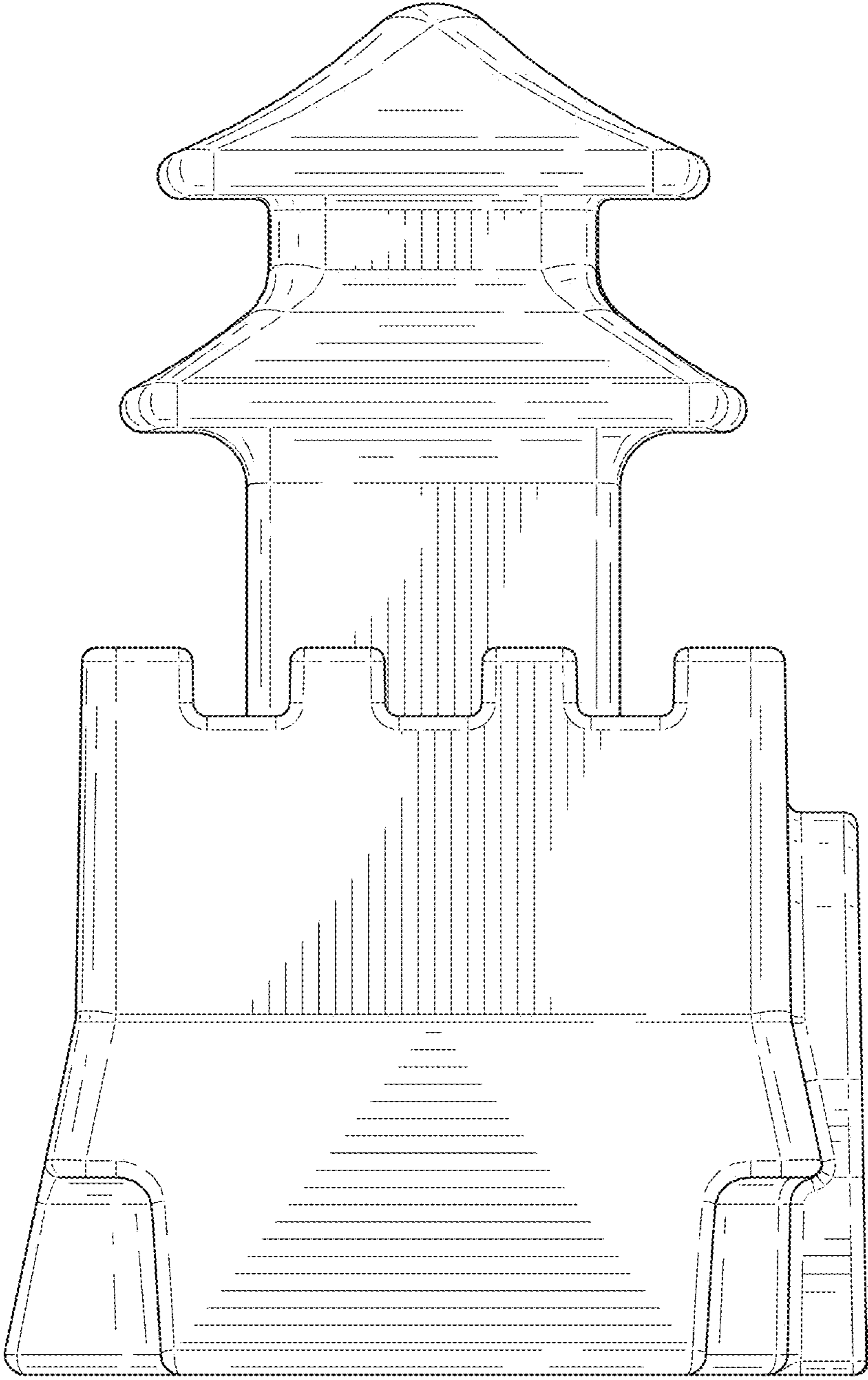

FIG. 59

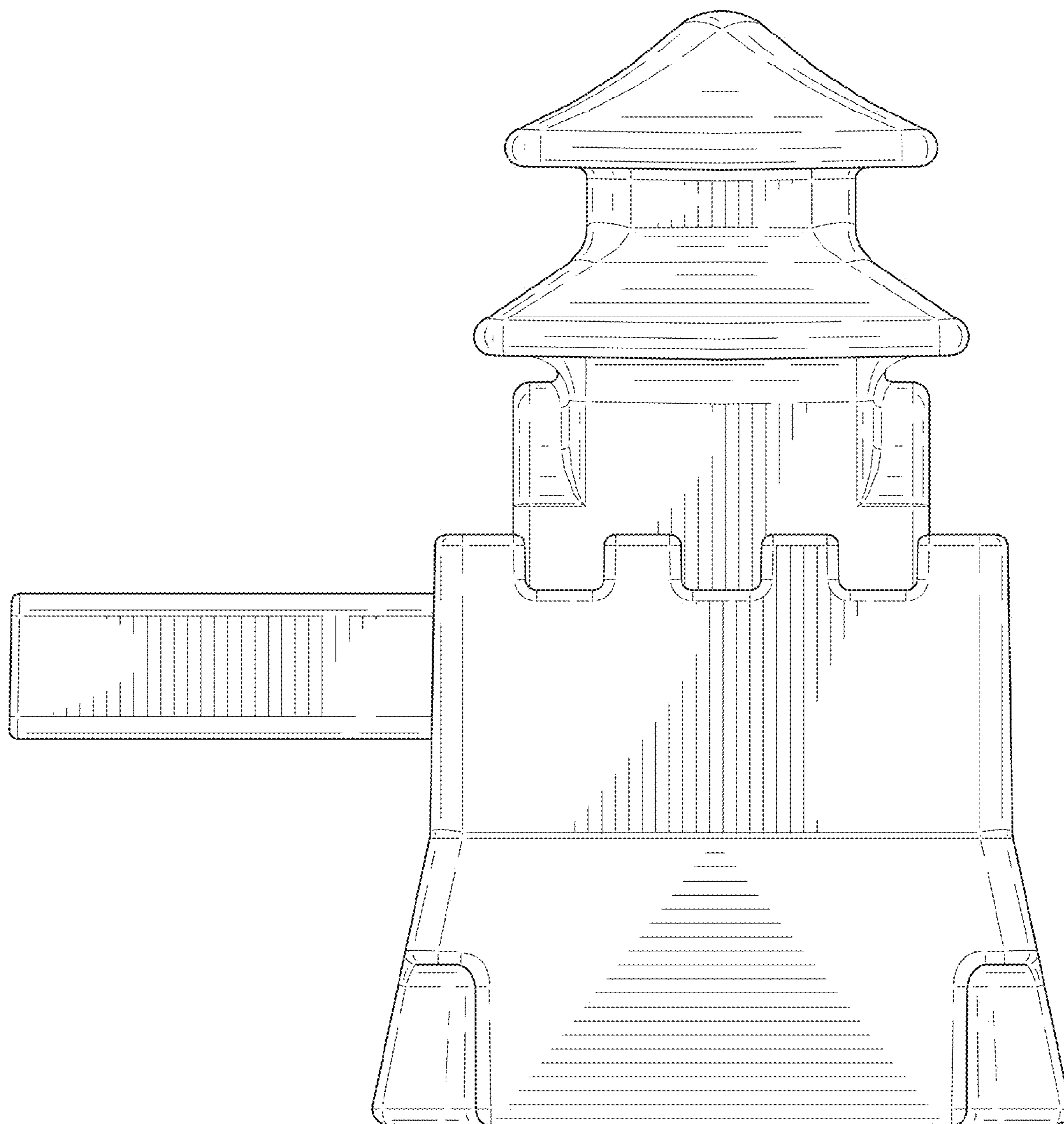

FIG. 60

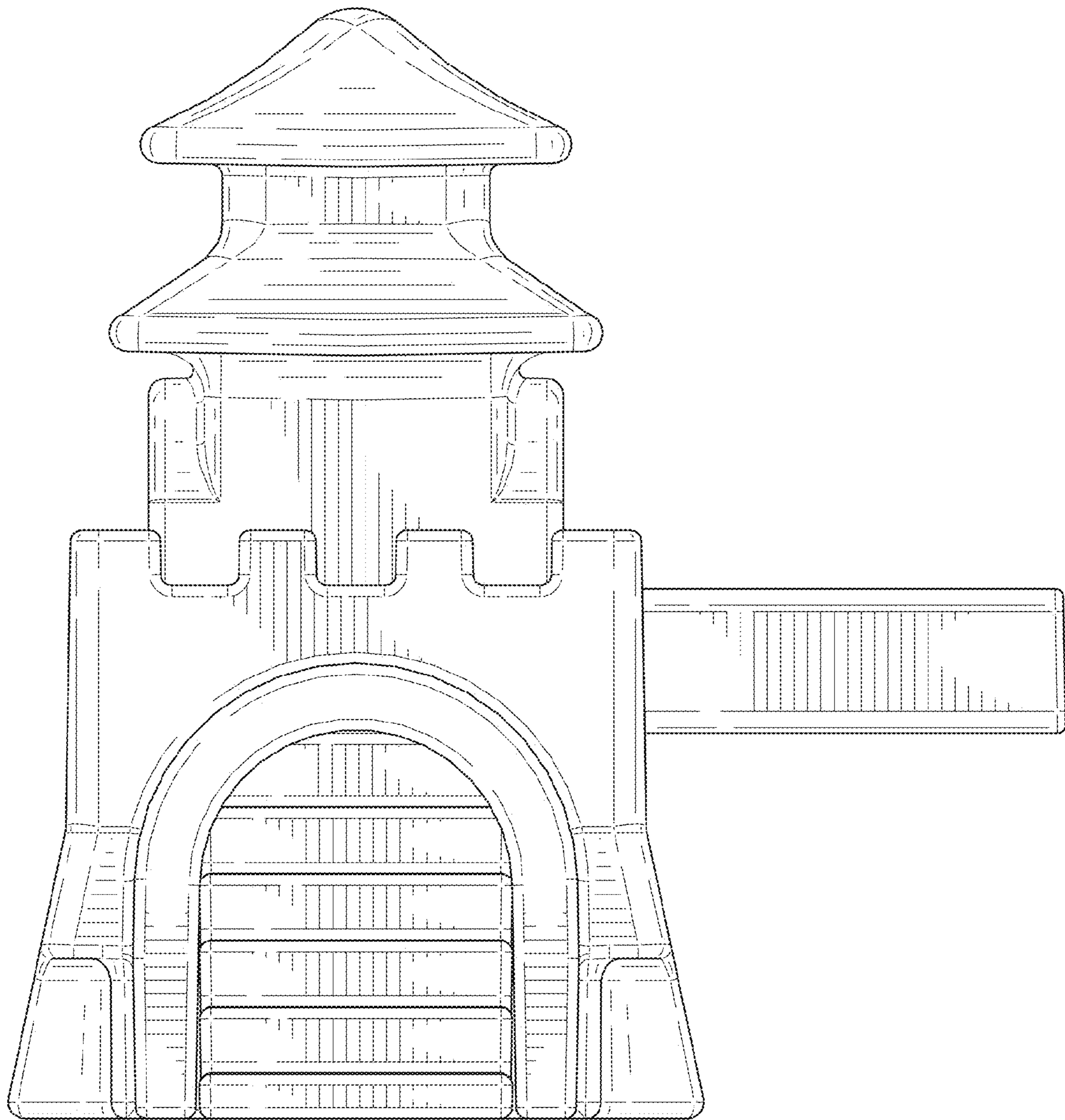

FIG. 61

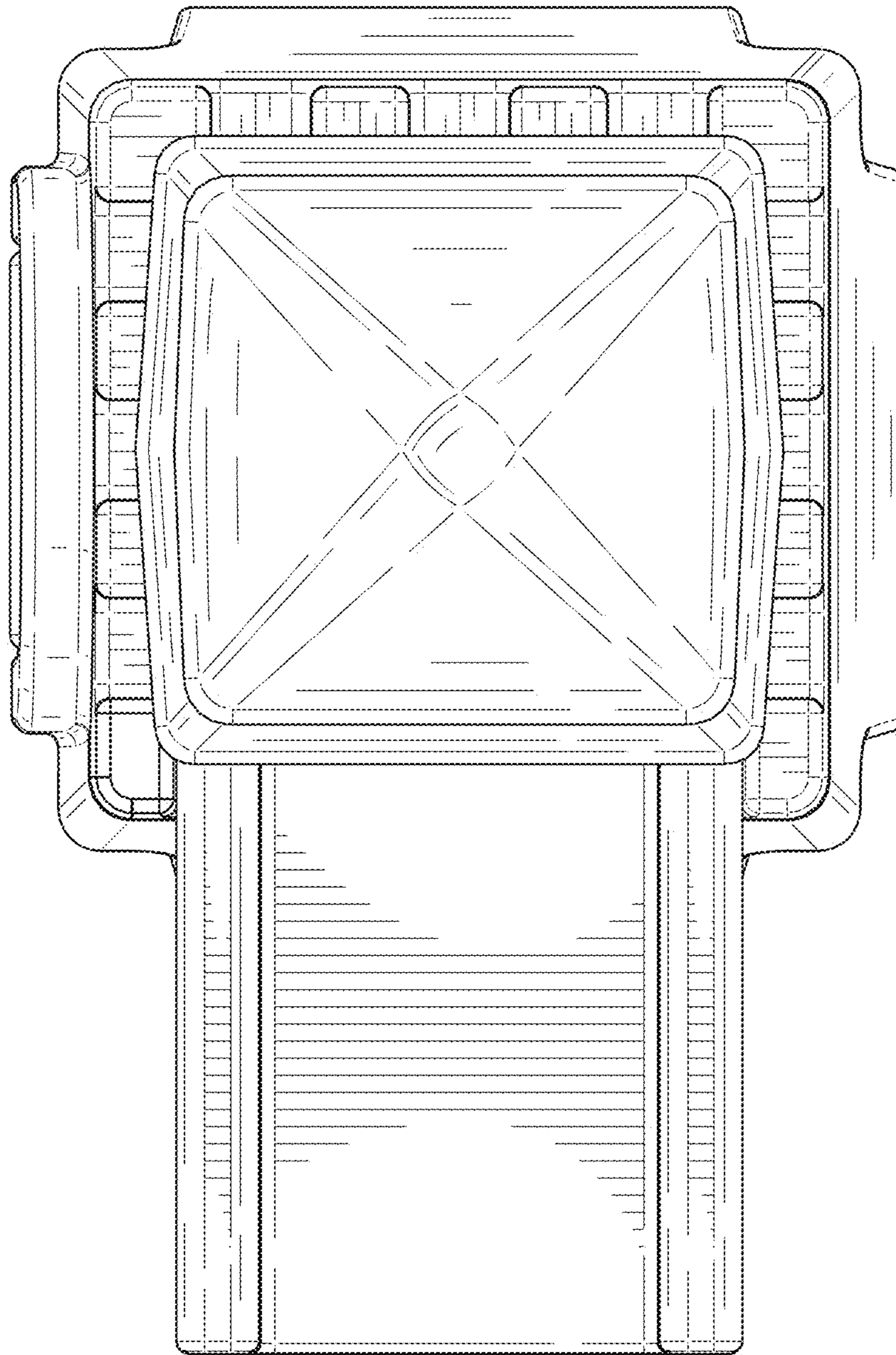

FIG. 62

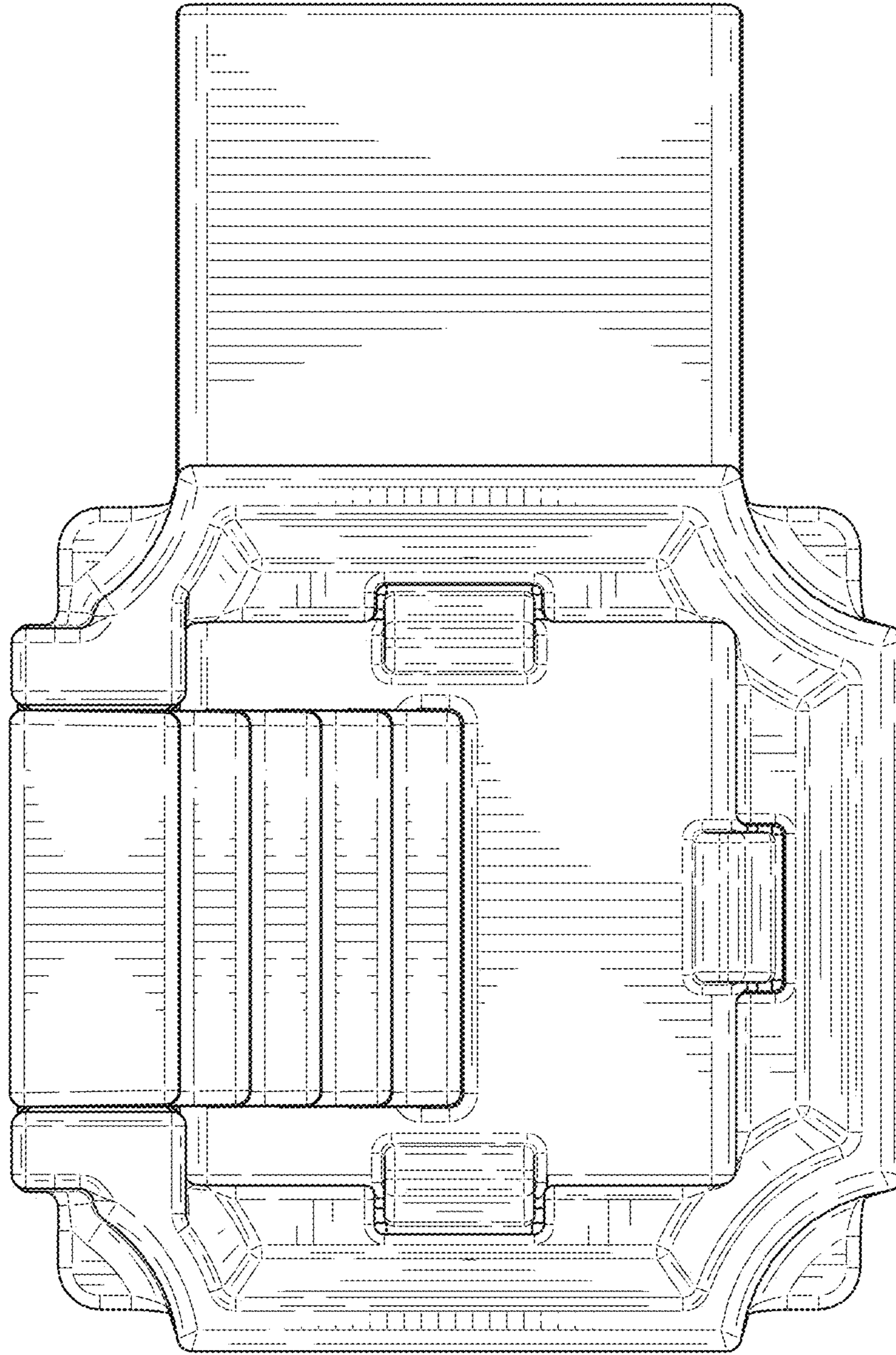

FIG. 63

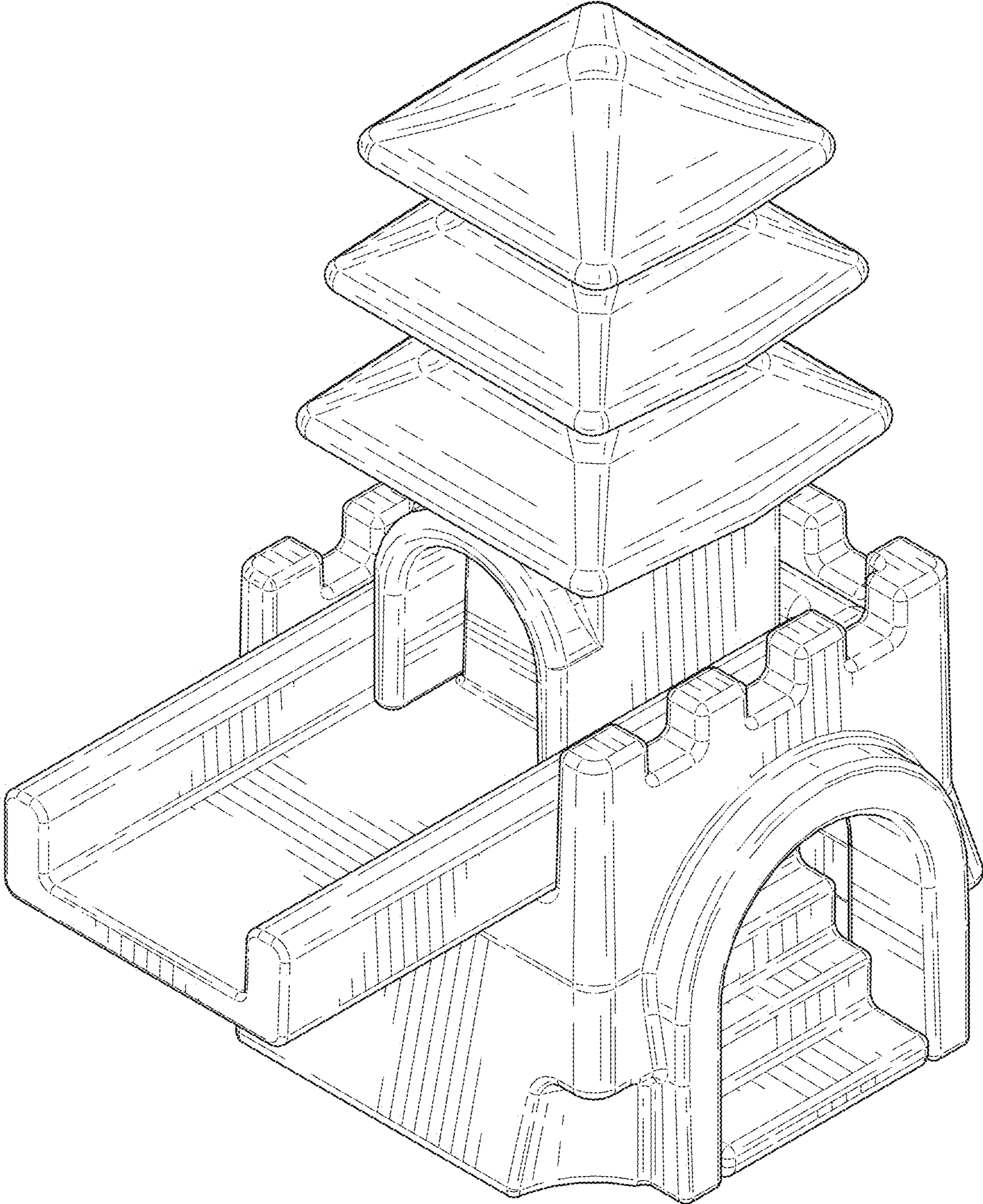

FIG. 64

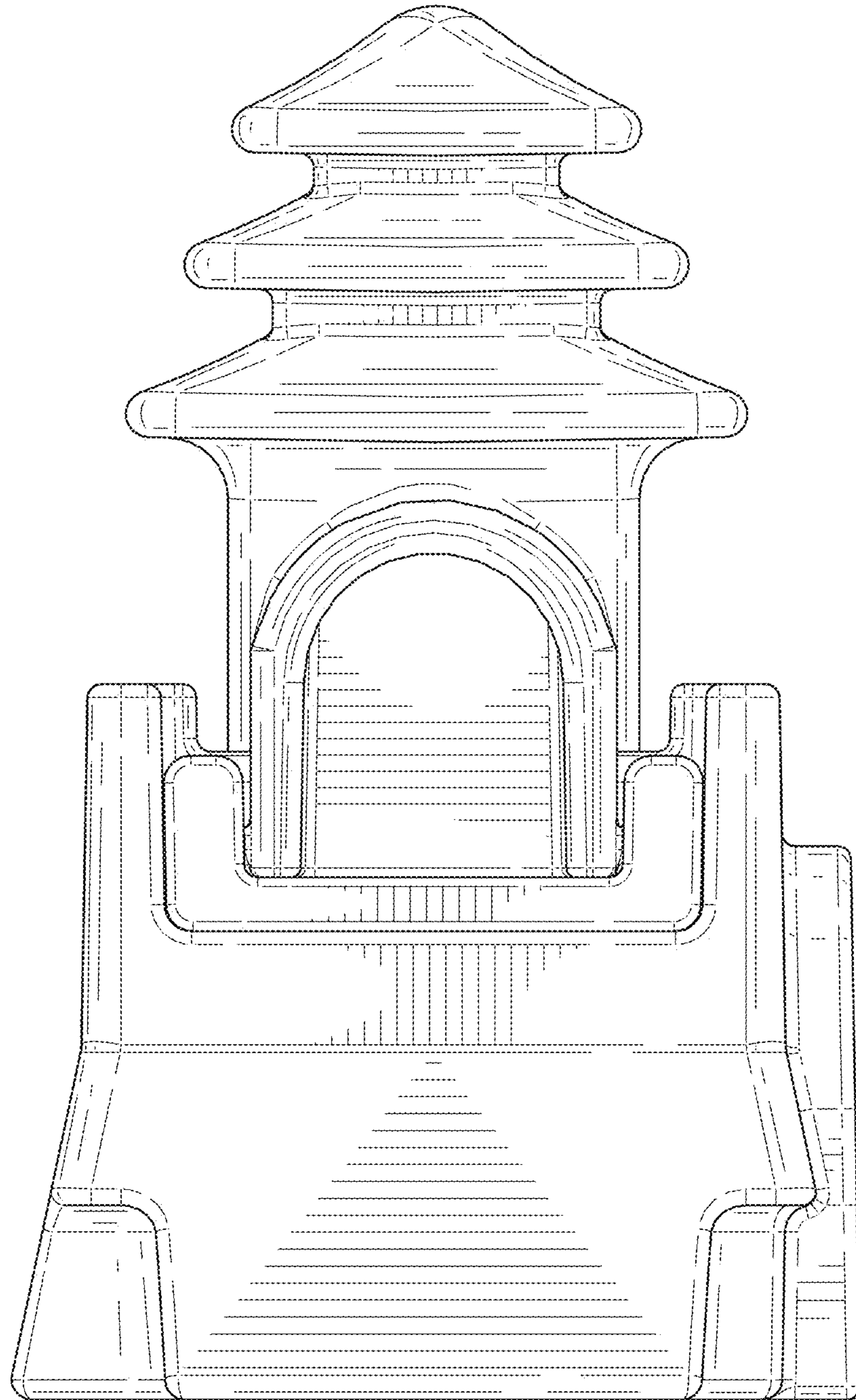

FIG. 65

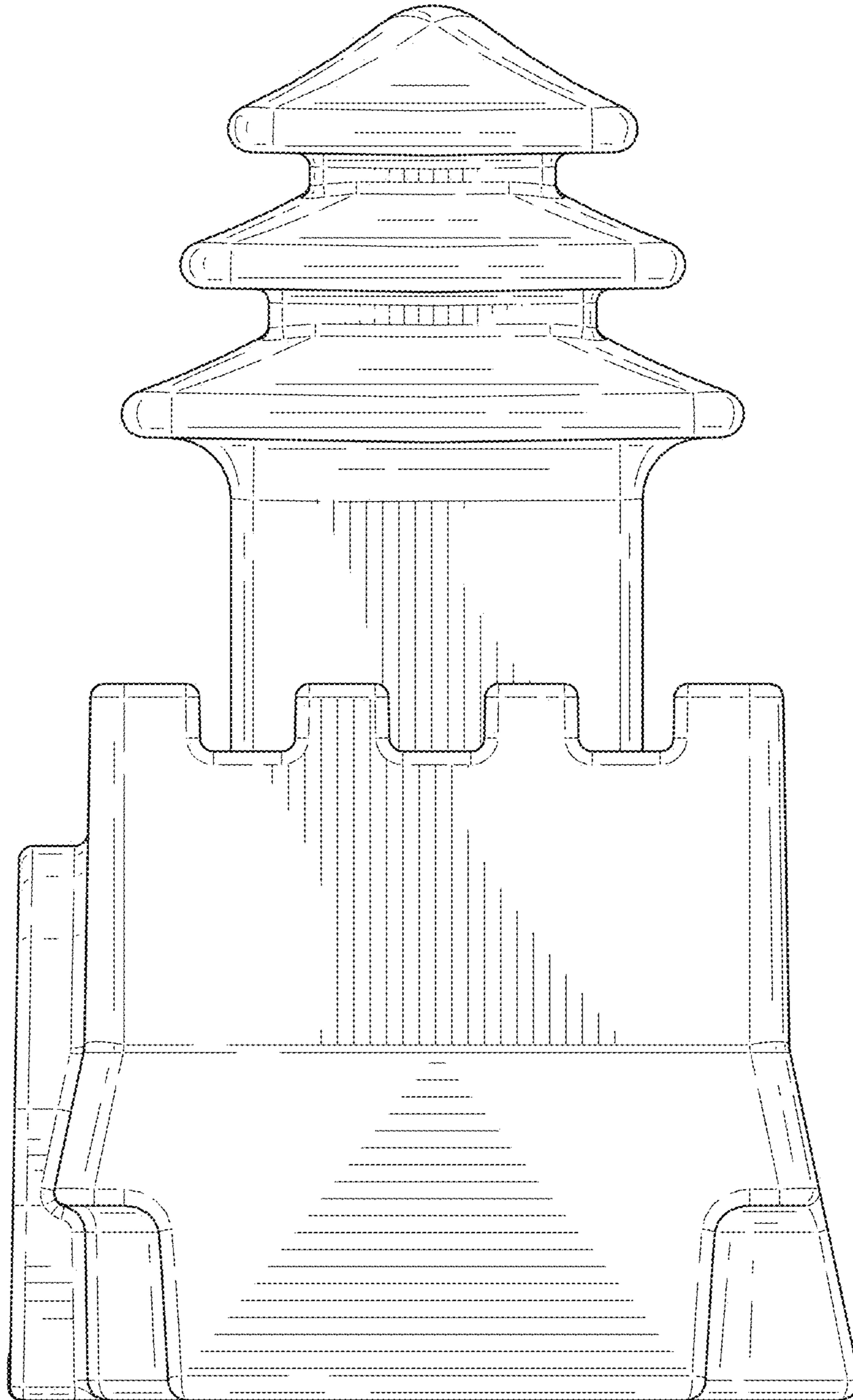

FIG. 66

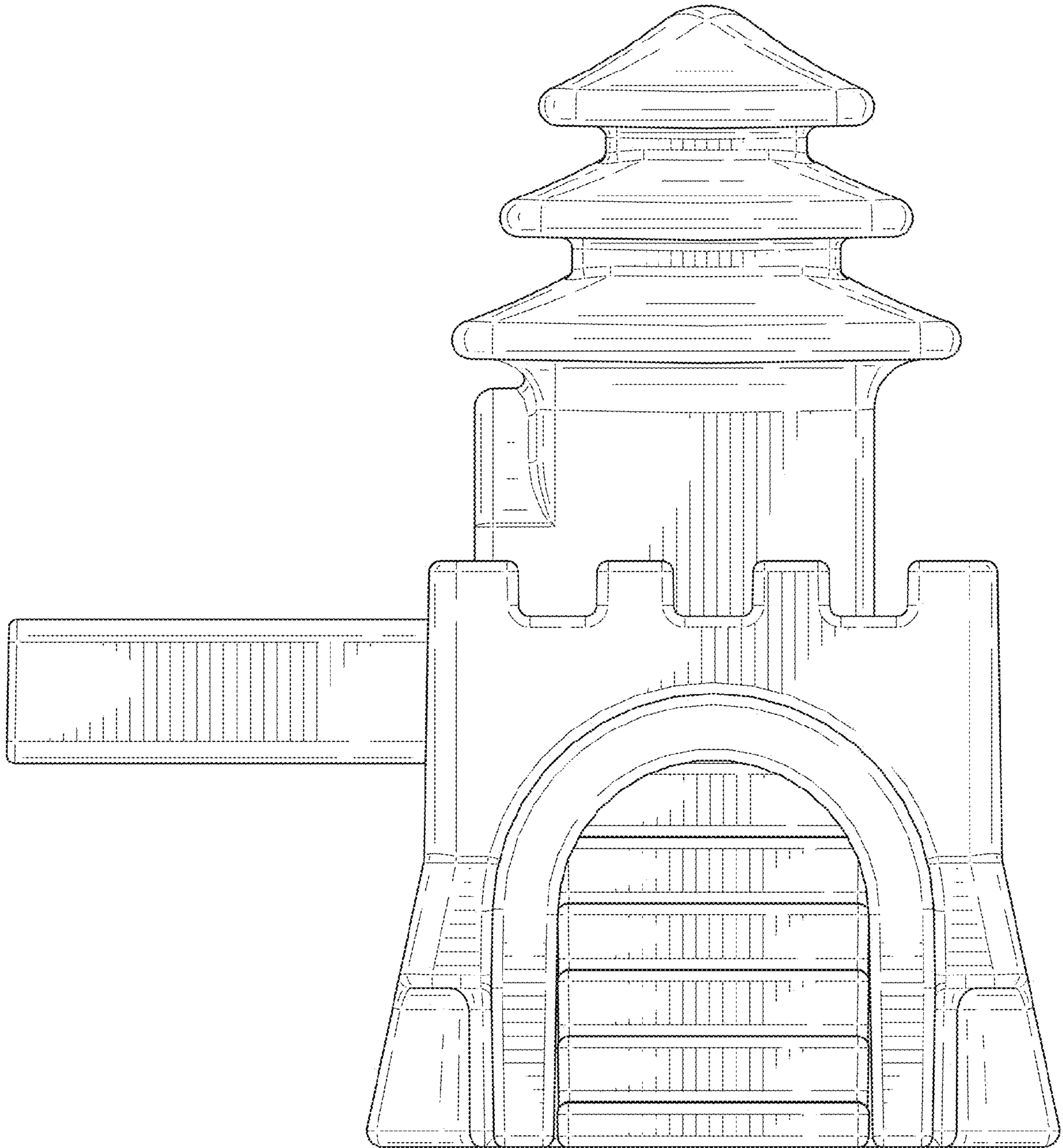

FIG. 67

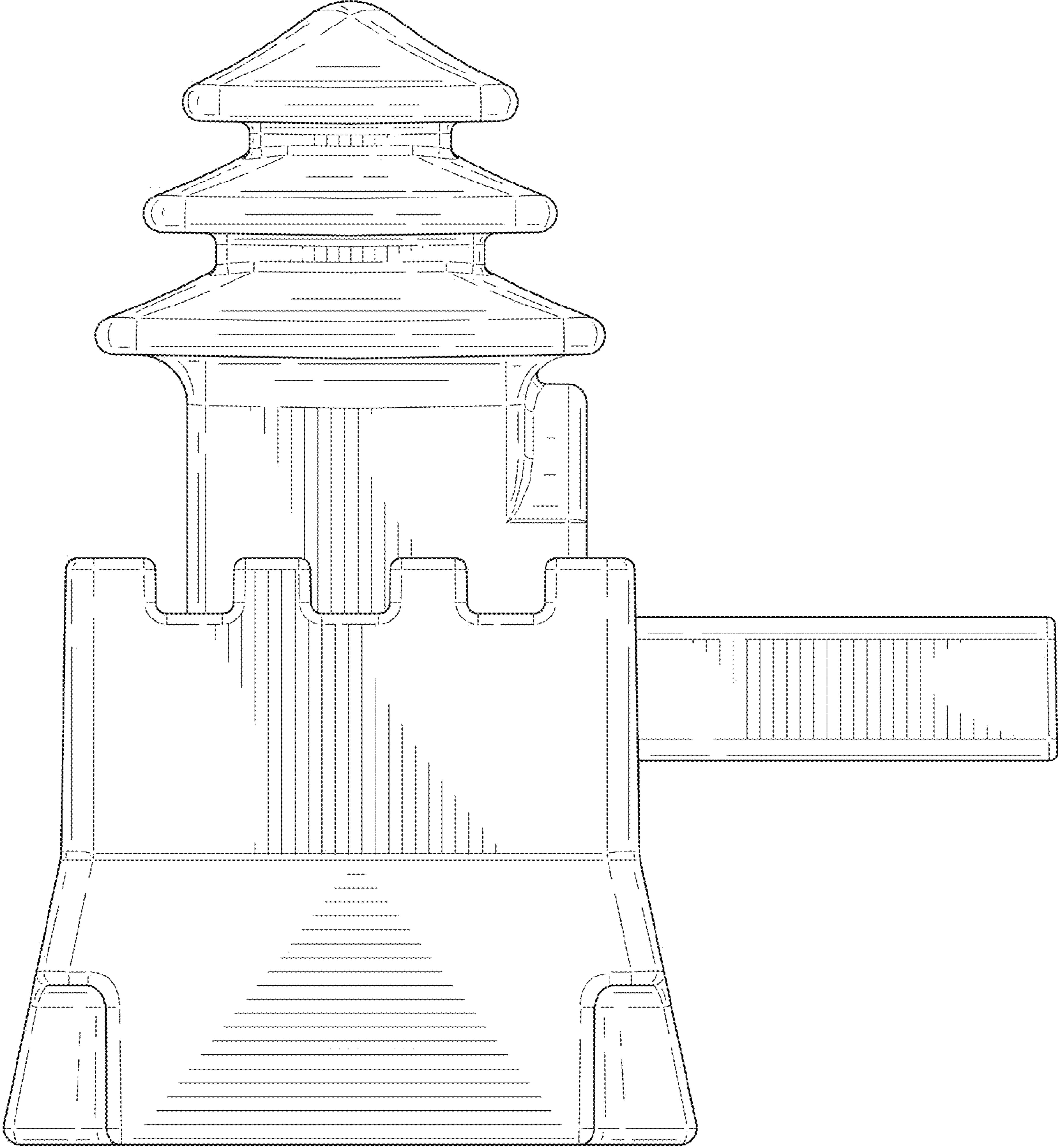

FIG. 68

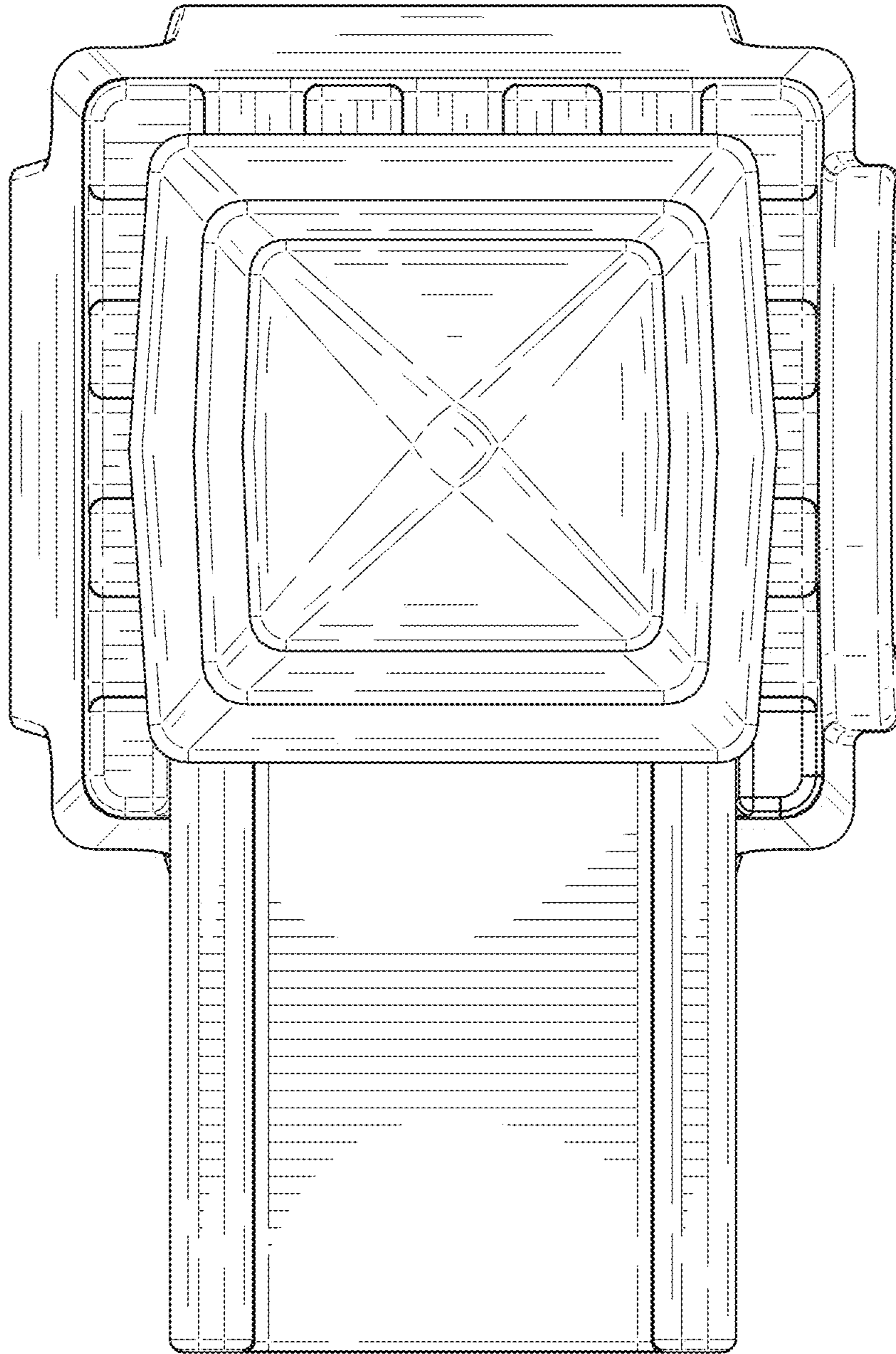

FIG. 69

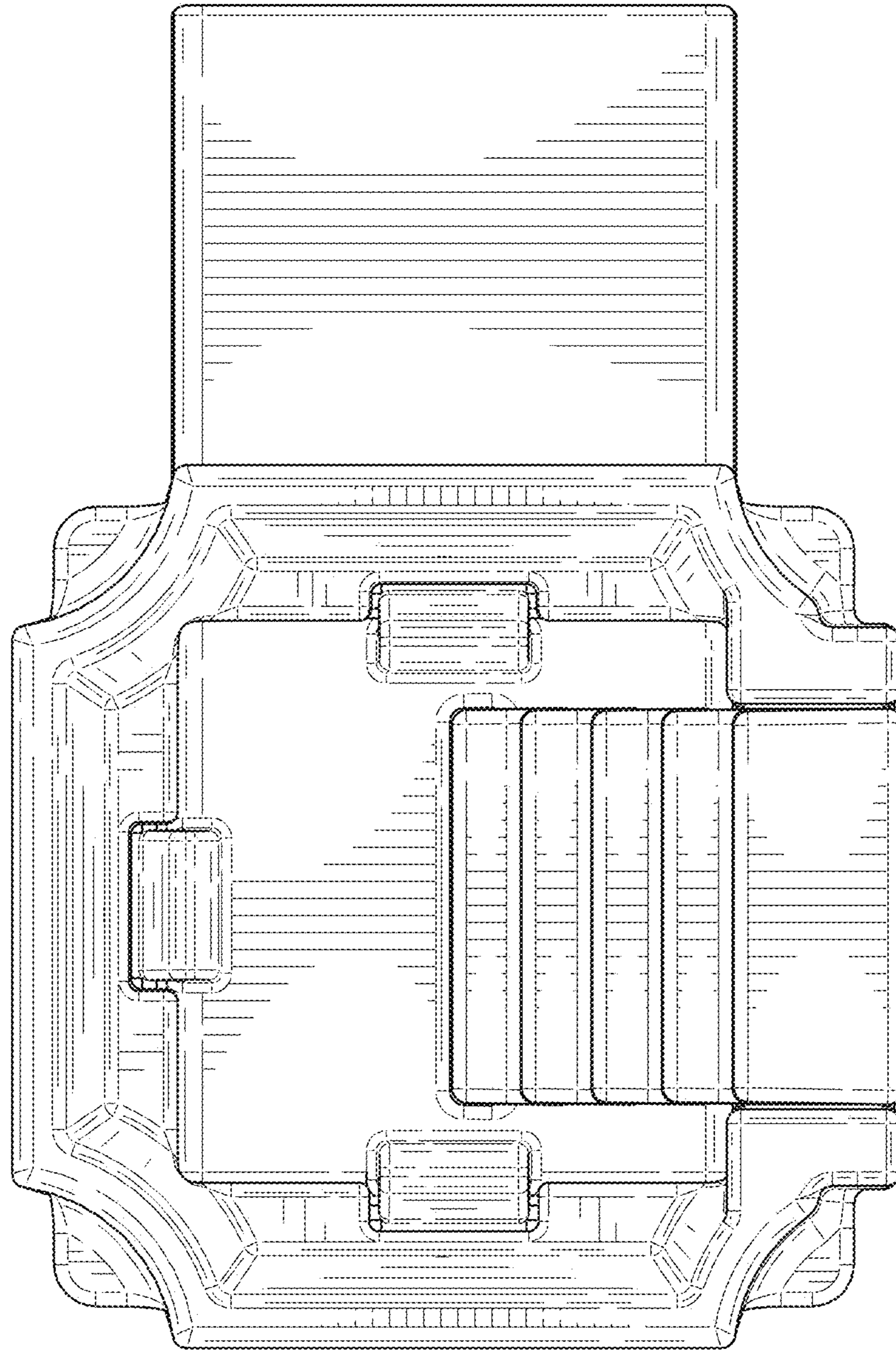

FIG. 70

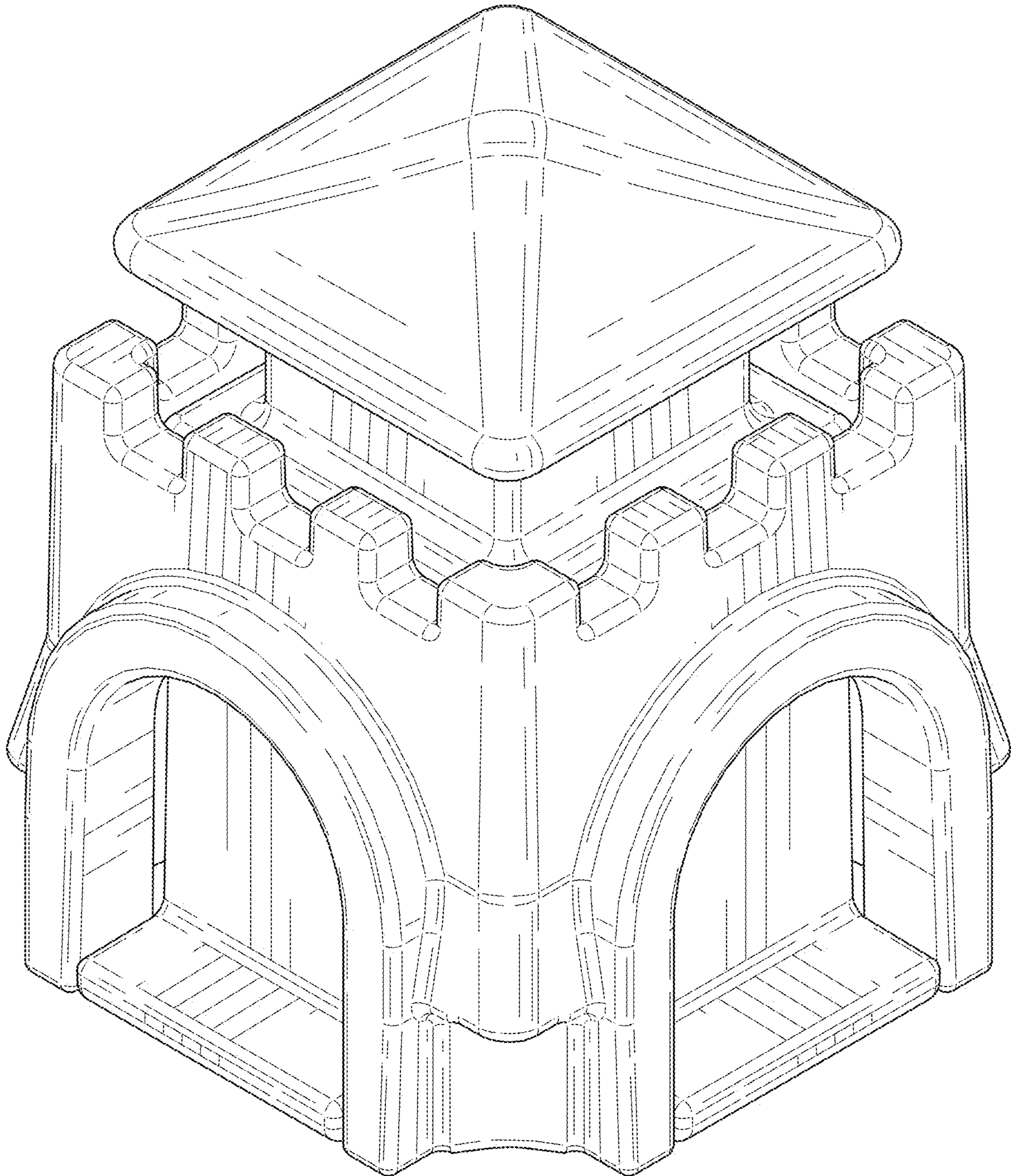

FIG. 71

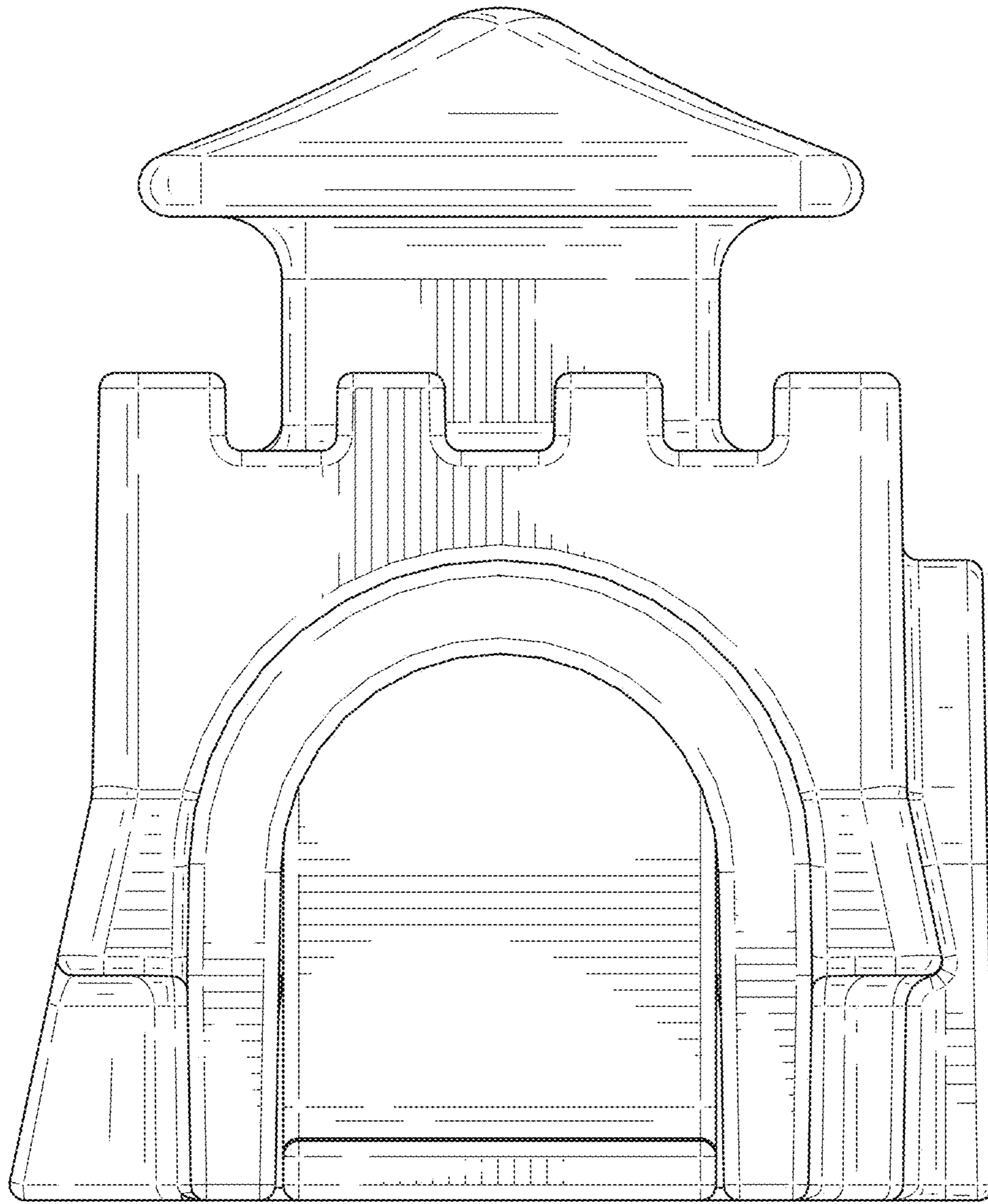

FIG. 72

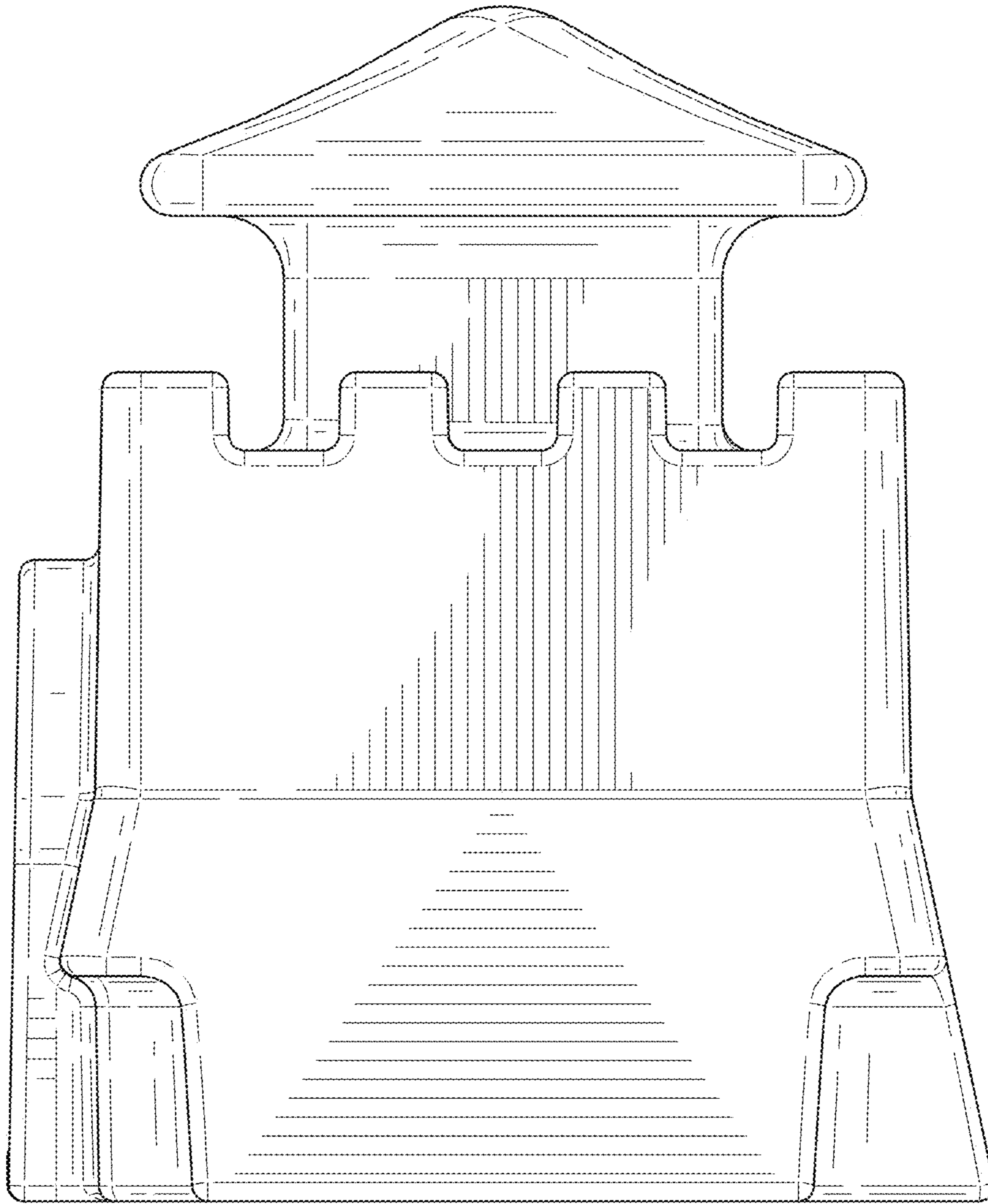

FIG. 73

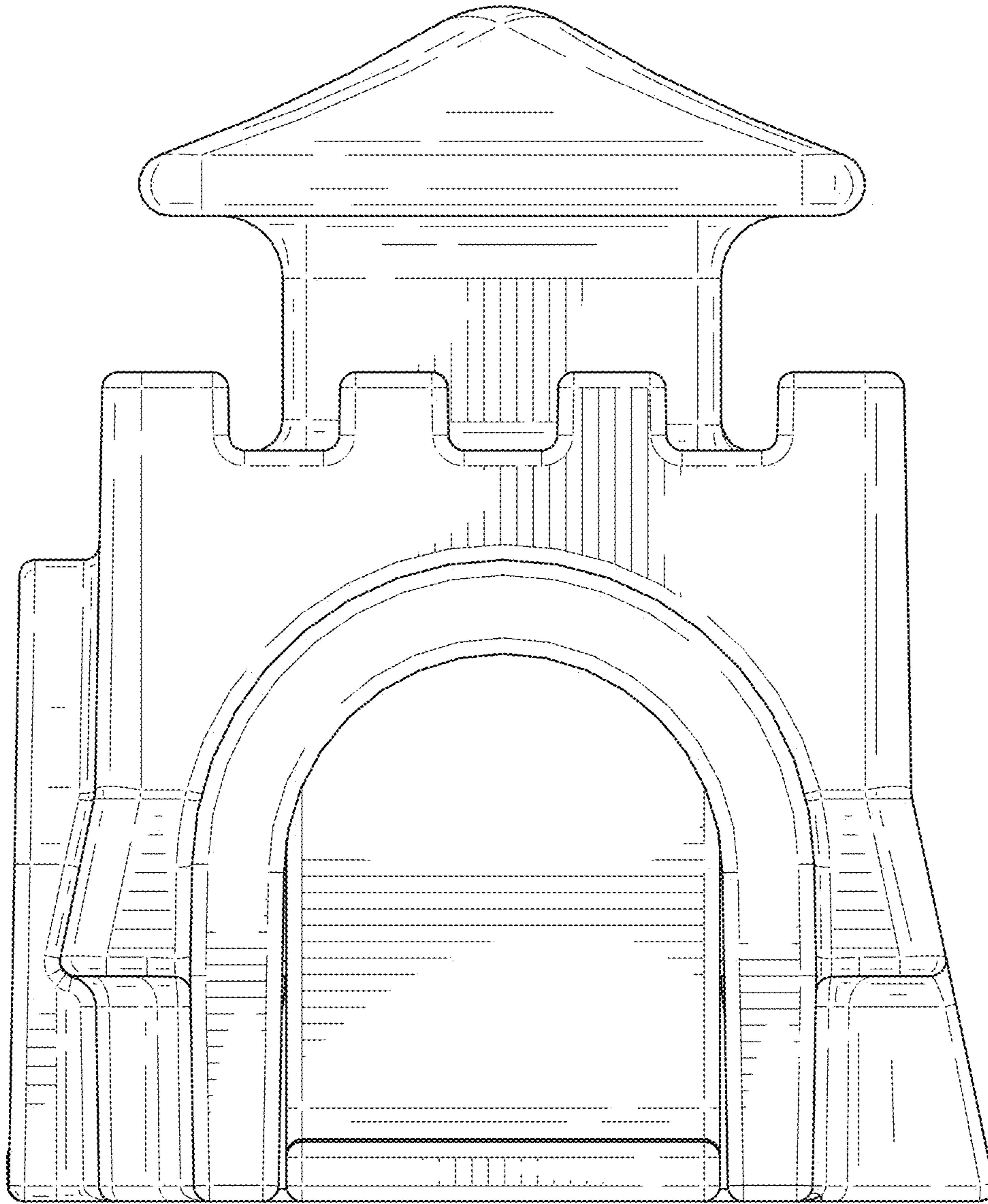

FIG. 74

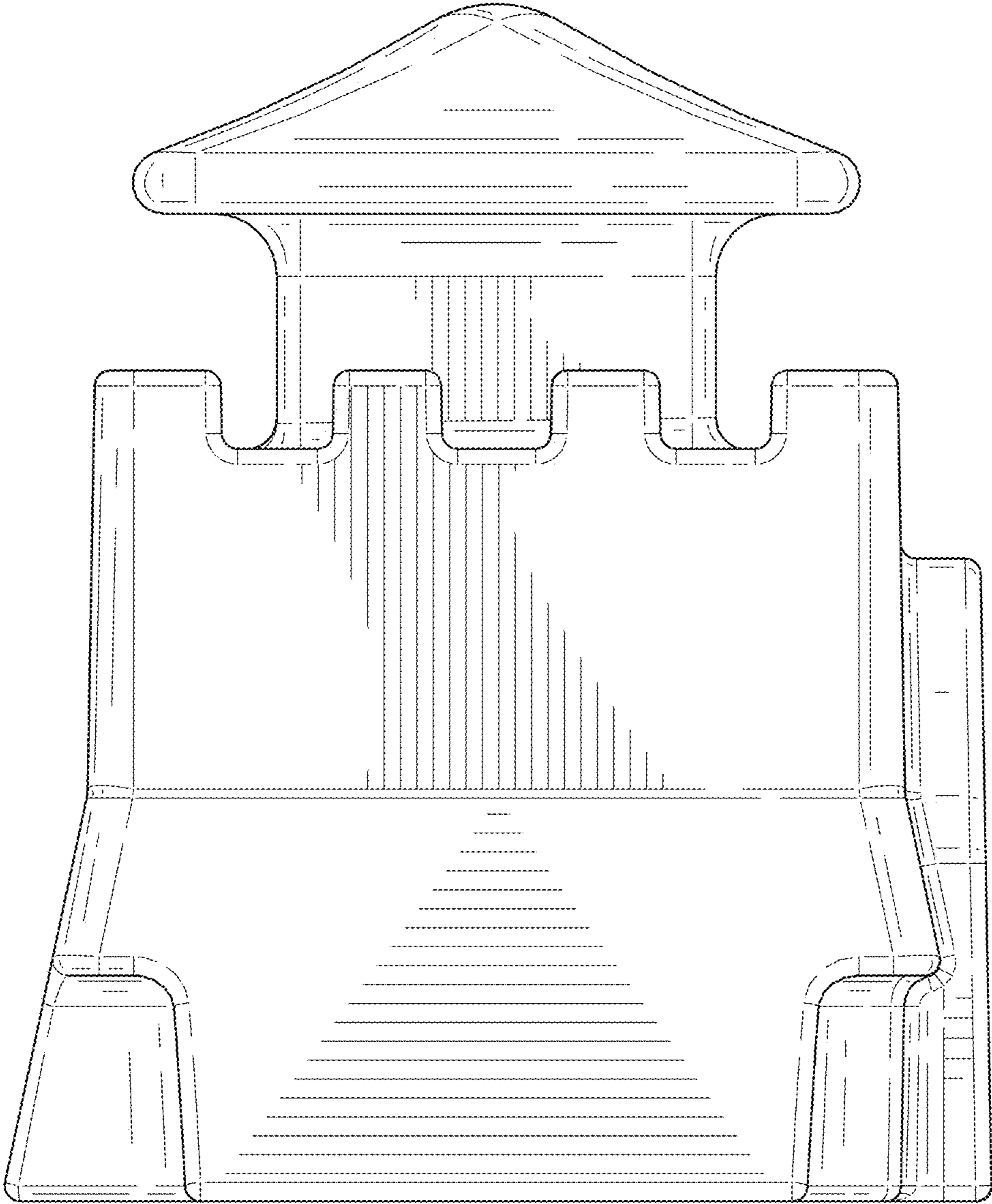

FIG. 75

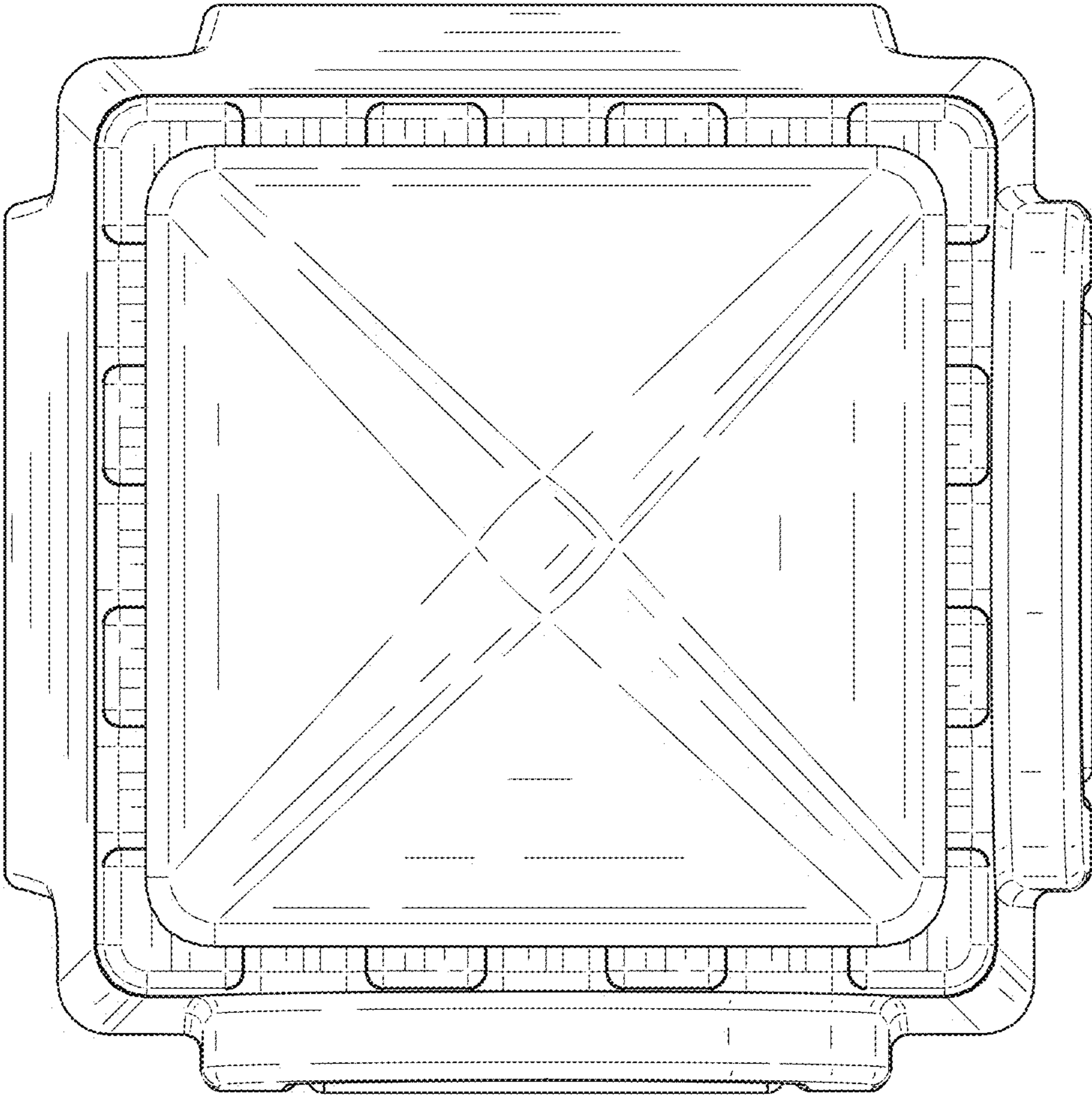

FIG. 76

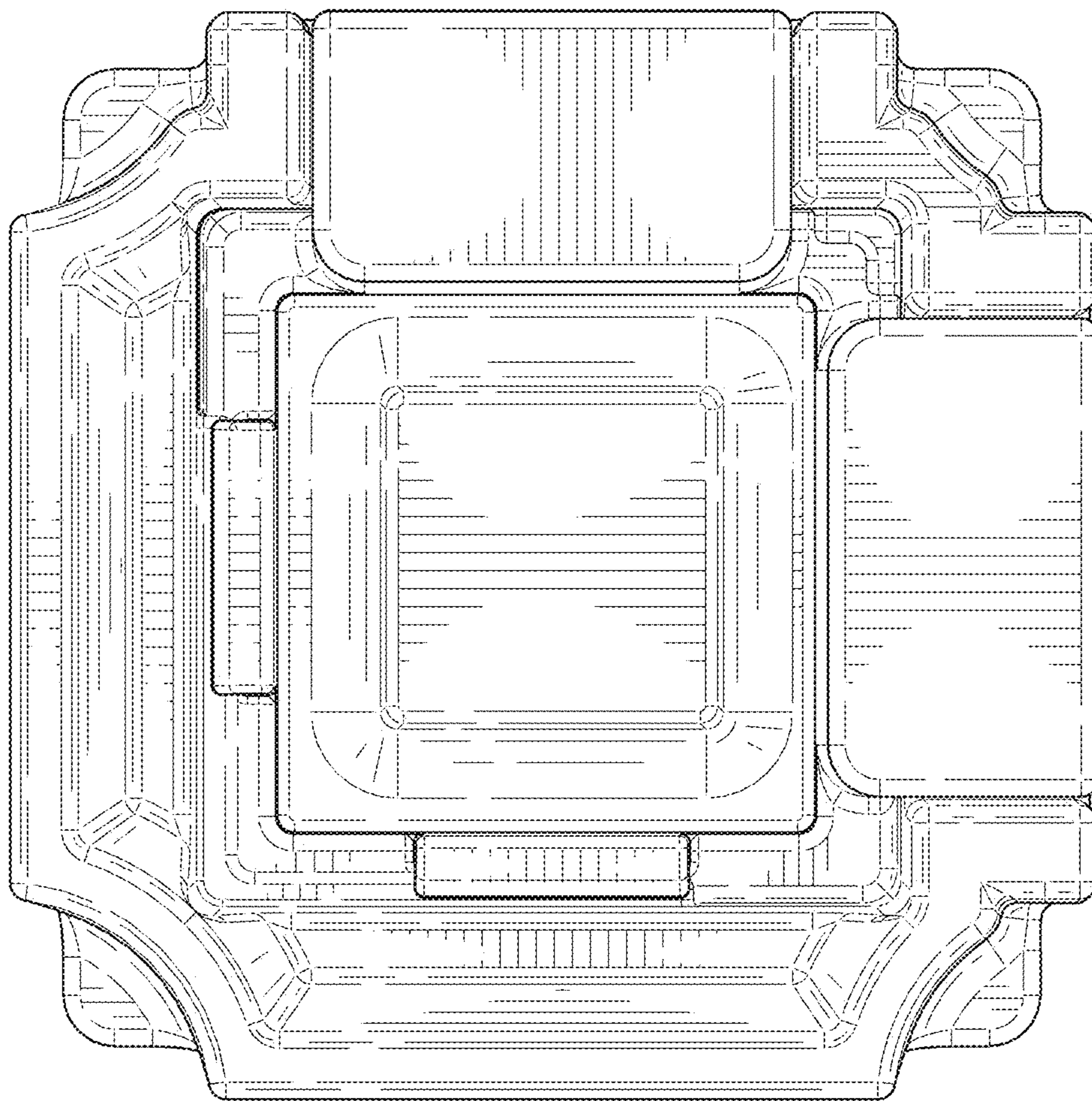

FIG. 77

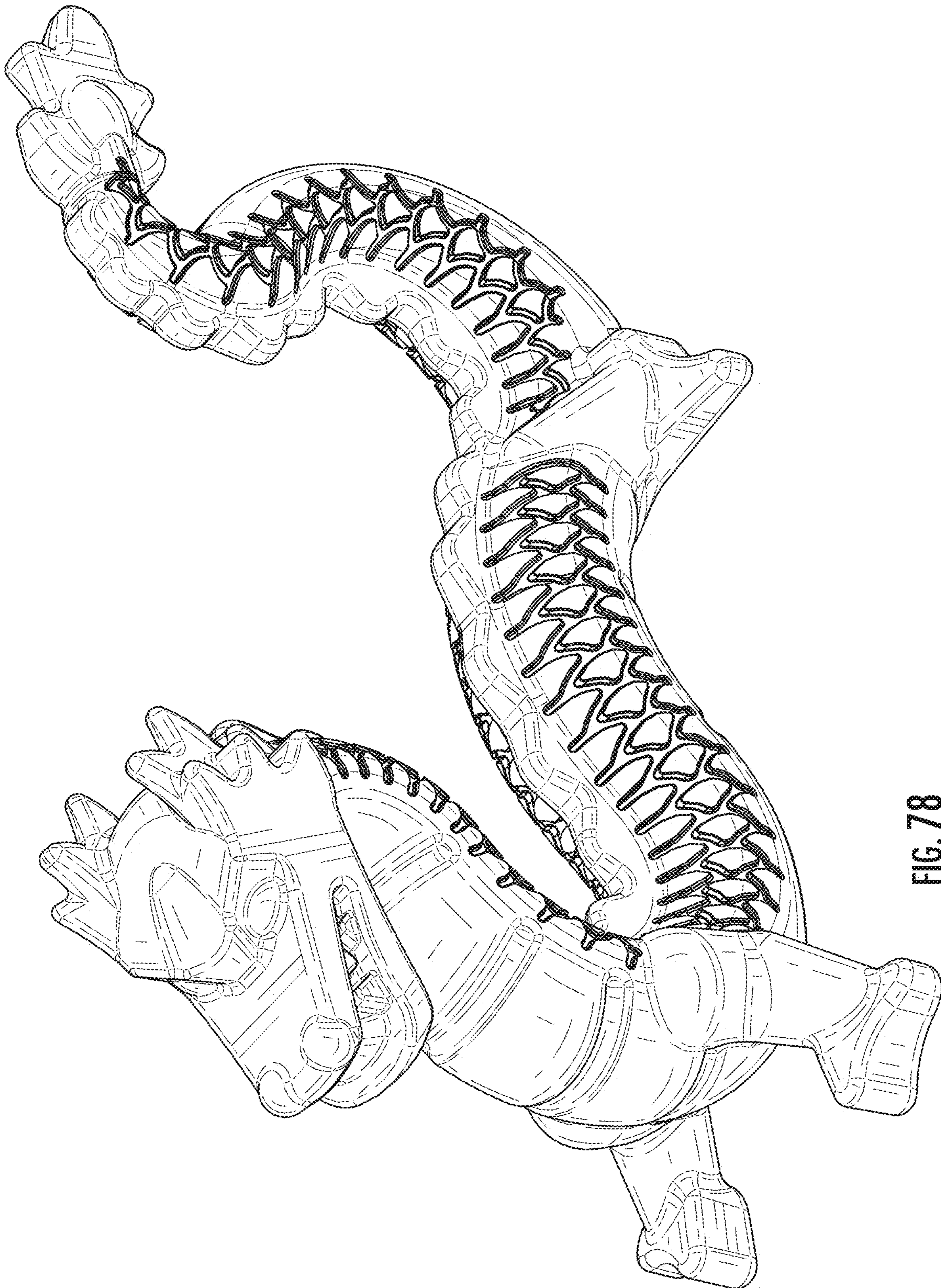

FIG. 78

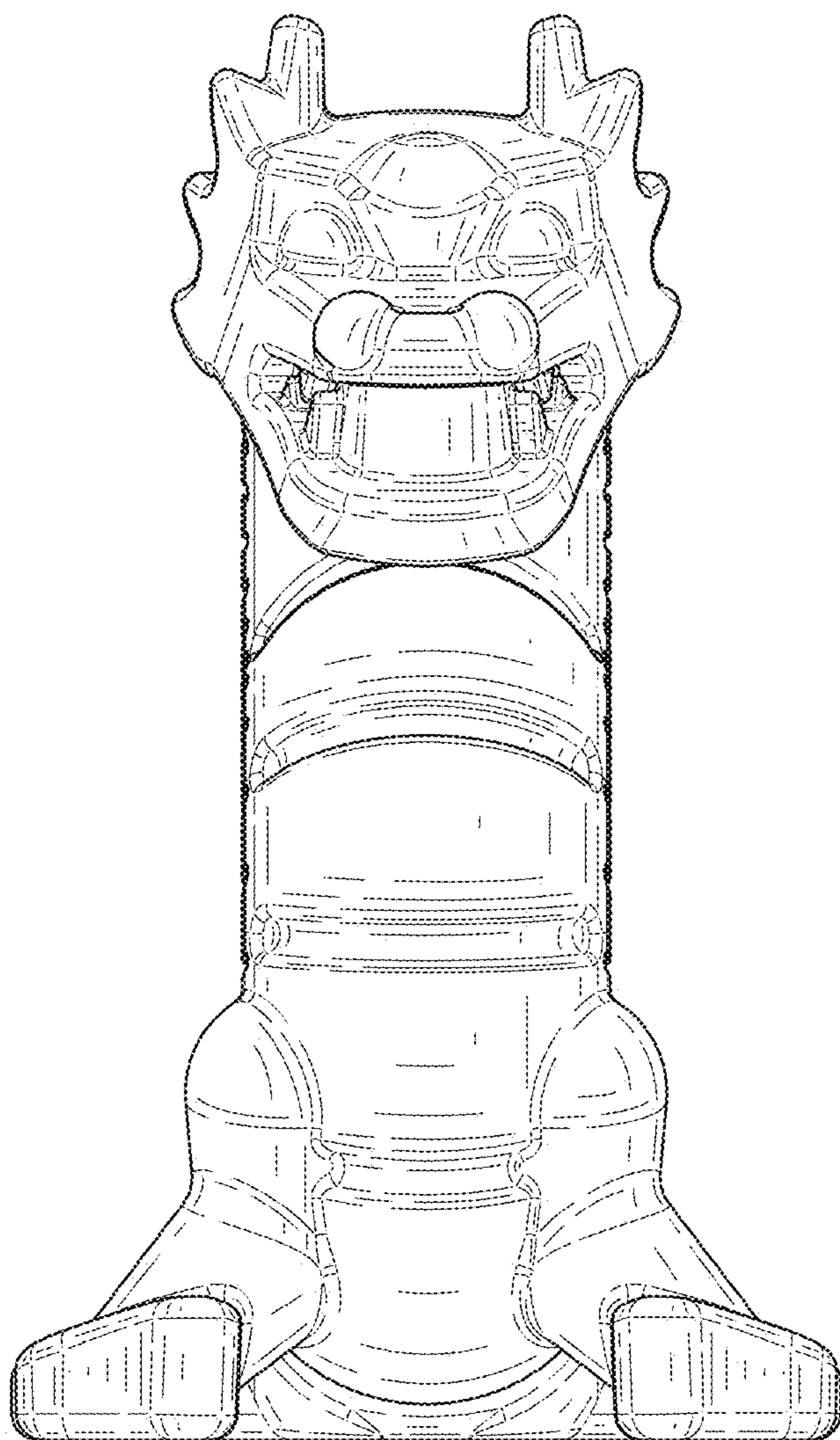

FIG. 79

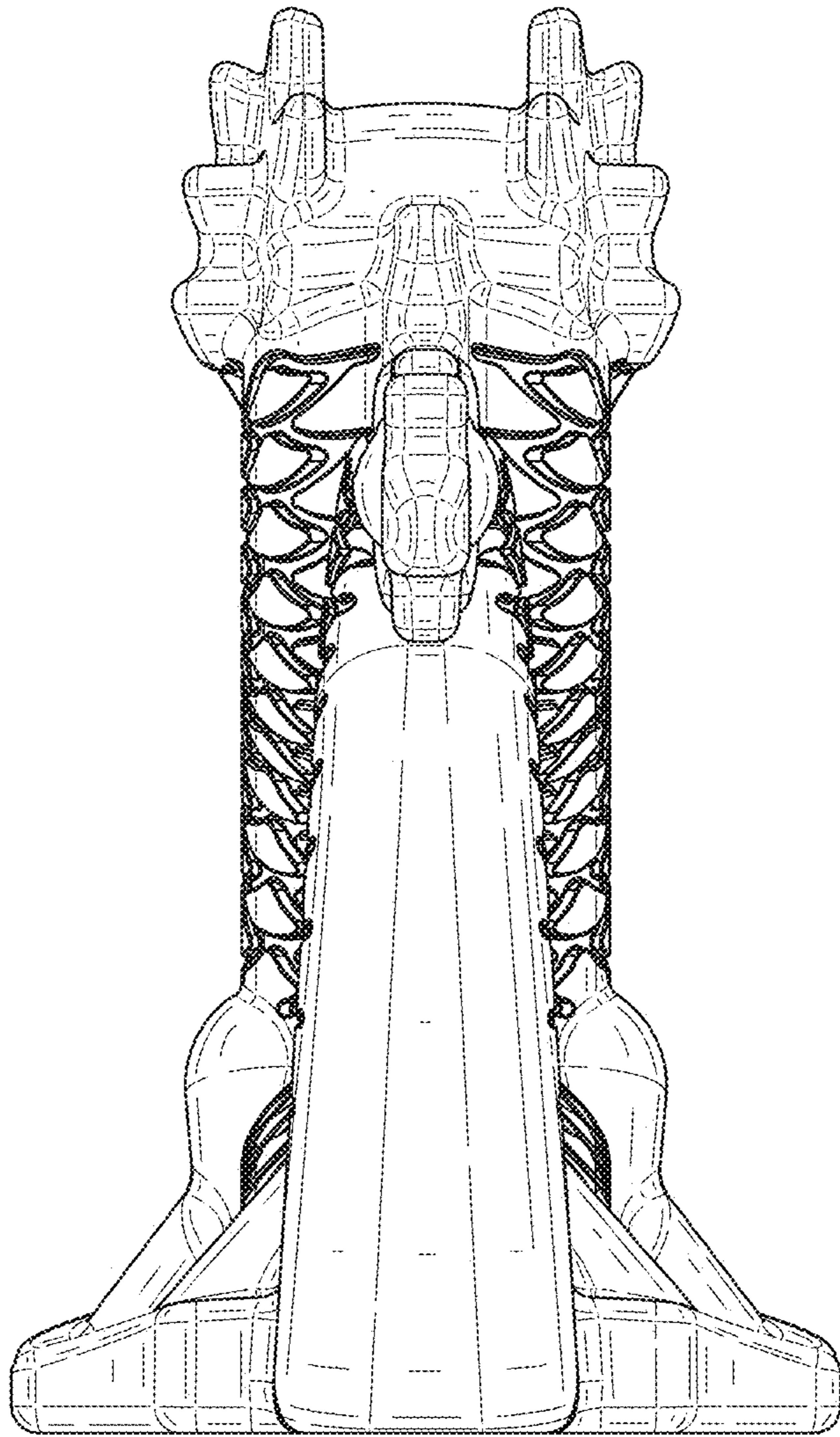

FIG. 80

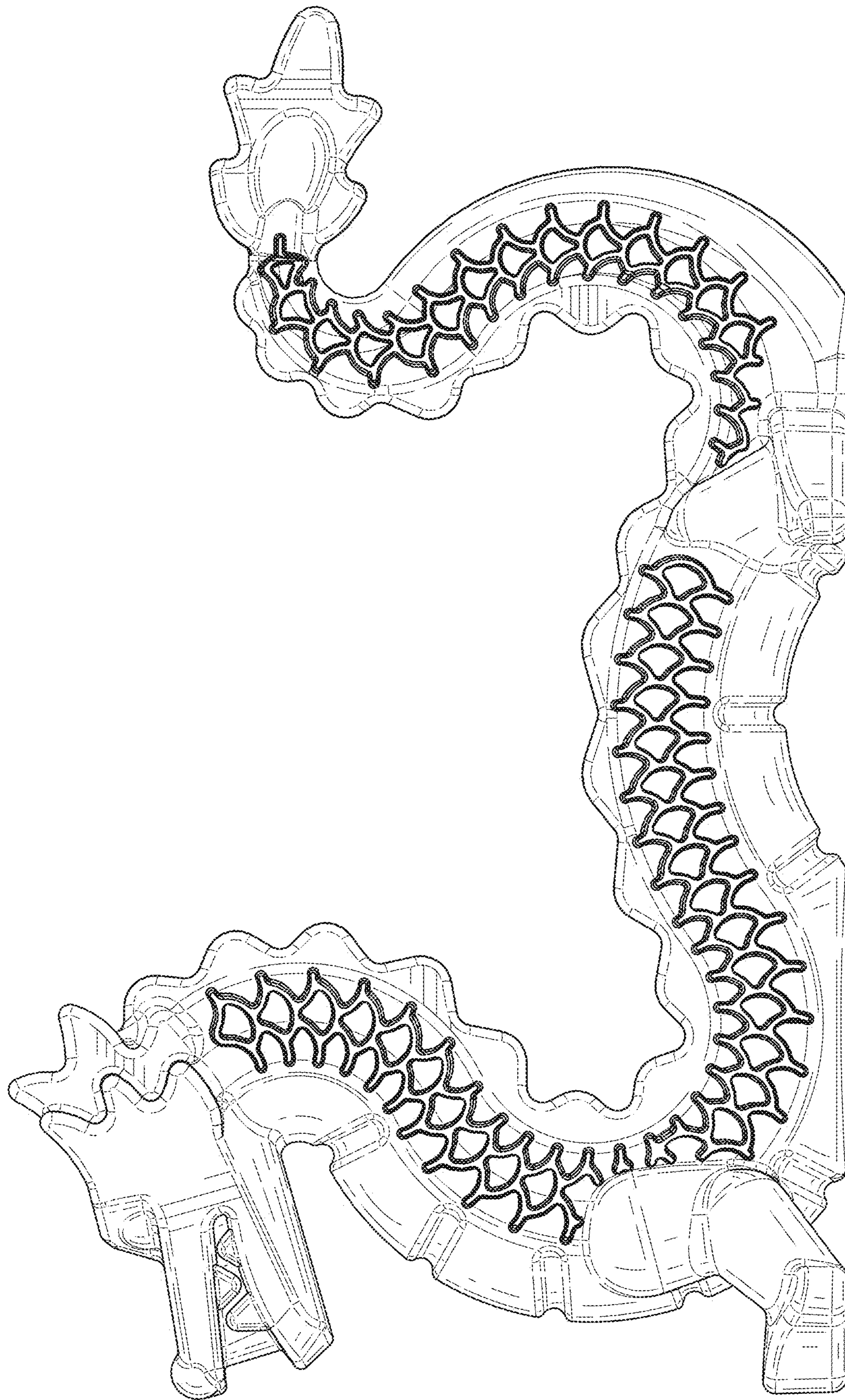

FIG. 81

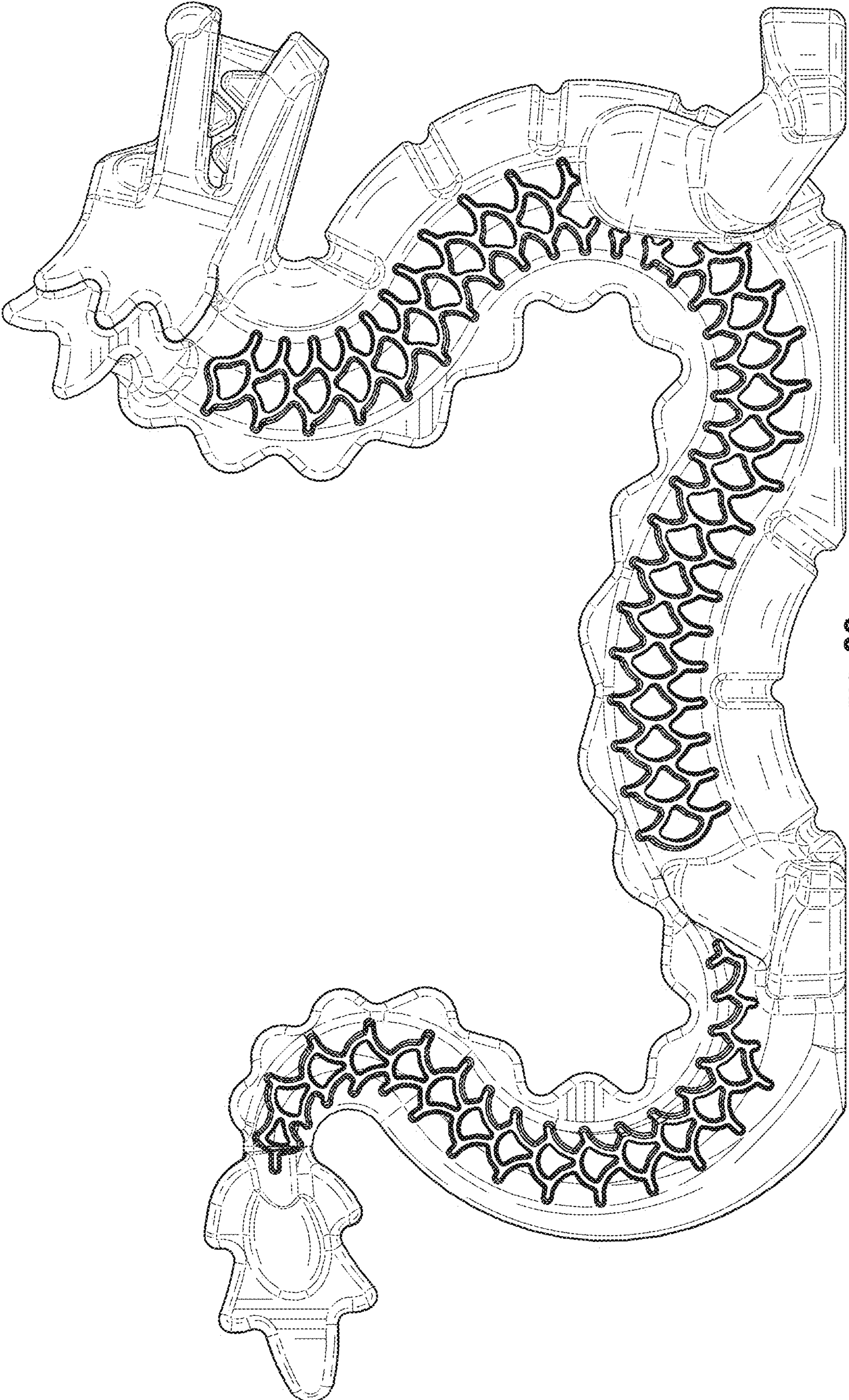

FIG. 82

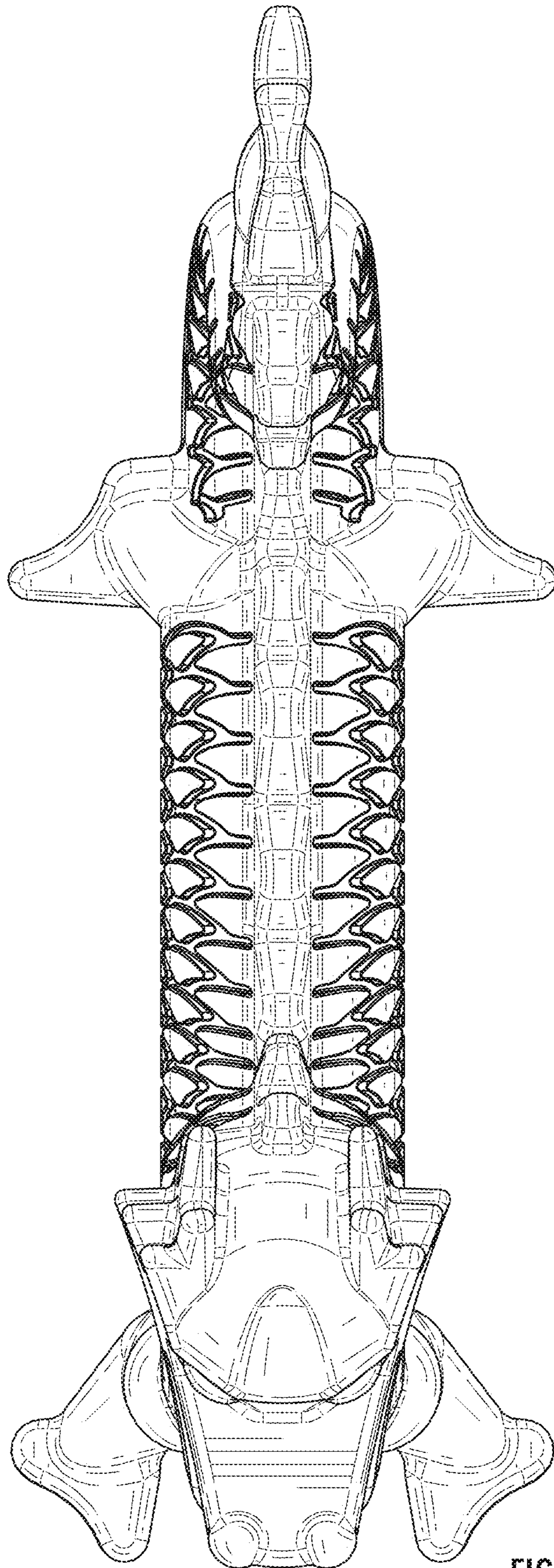

FIG. 83

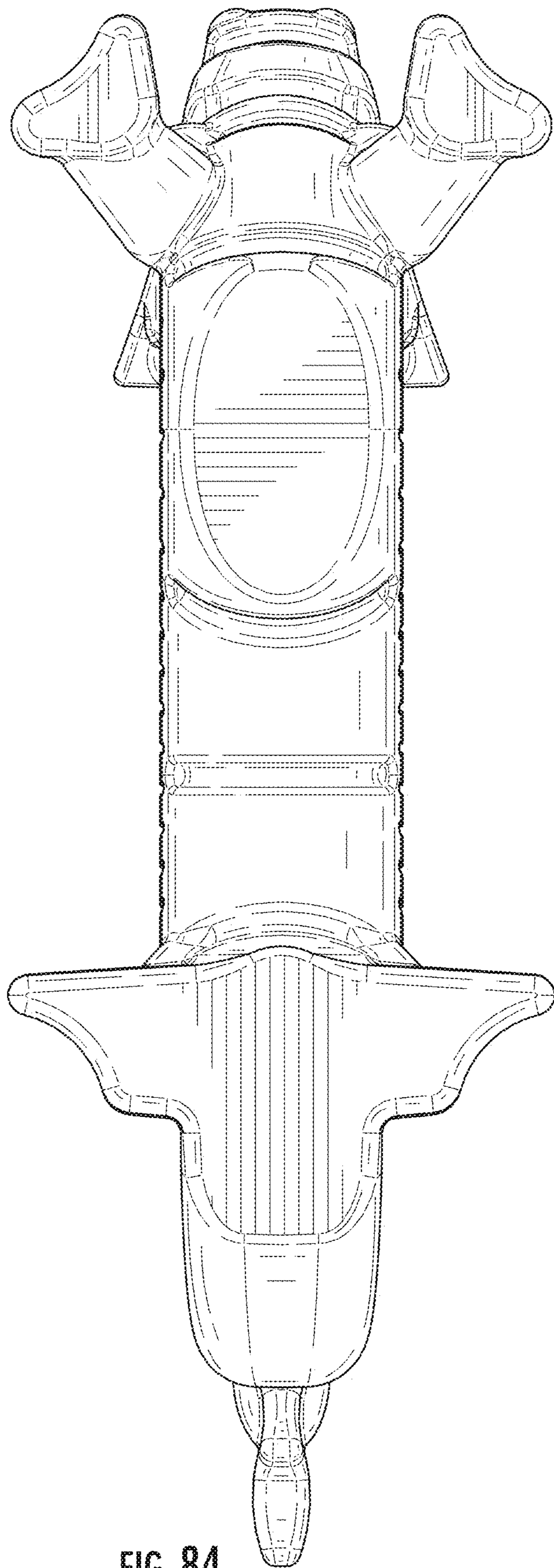

FIG. 84

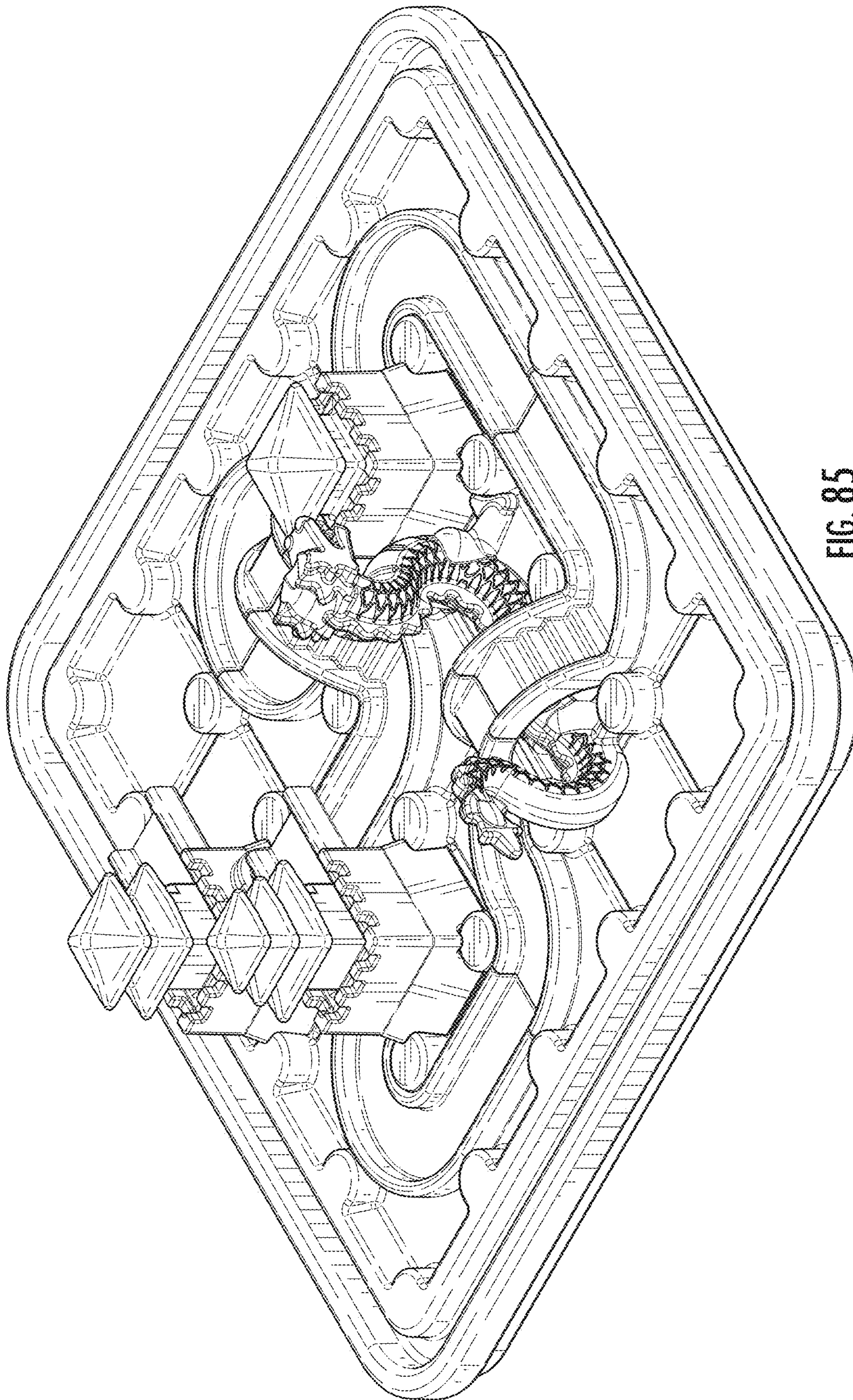

FIG. 85