



US00D915833S

(12) **United States Design Patent** (10) **Patent No.:** **US D915,833 S**
Amatoury et al. (45) **Date of Patent:** **** Apr. 13, 2021**

(54) **EATING UTENSIL**

(71) Applicant: **b.box for kids developments Pty Ltd,**
Mulgrave (AU)

(72) Inventors: **Sylvain Jacques Amatoury,** Mulgrave
(AU); **Lisa Edlund Tjernberg,**
Mulgrave (AU)

(73) Assignee: **b.box for kids developments Pty Ltd,**
Mulgrave (AU)

(**) Term: **15 Years**

(21) Appl. No.: **29/700,514**

(22) Filed: **Aug. 2, 2019**

(51) **LOC (13) Cl.** **07-03**

(52) **U.S. Cl.**
USPC **D7/644; D7/401.2; D7/653**

(58) **Field of Classification Search**

USPC D7/368, 401.2, 642-650, 653-664, 669,
D7/675-677, 683, 686-689, 691;
D8/107, 300-301; D10/46.2; D21/532;
D22/117-118

CPC ... A01D 9/02; A01D 9/04; A01D 9/06; A47G
21/00; A47G 21/004; A47G 21/005;
A47G 21/02; A47G 21/023; A47G 21/04;
A47G 21/06; A47G 21/08; A47J 43/28;
A47J 43/281; A47J 43/282; A61F 13/10;
A61J 7/0023; B25G 1/00; B25G 1/01;
B25G 1/02; B25G 3/00; B65D 75/56;
B65D 75/563; B65D 75/566; B67B 7/00;
B67B 7/724; B67B 7/73

See application file for complete search history.

(56) **References Cited**

U.S. PATENT DOCUMENTS

D284,342 S *	6/1986	Campbell	D10/46.2
D356,349 S *	3/1995	Kino	A63H 33/32
				D21/532
D405,660 S *	2/1999	Hansen	D7/688
D510,506 S *	10/2005	Tranfaglia	D7/656
D631,709 S *	2/2011	Holcomb	D7/686
D696,553 S *	12/2013	Desrochers	D7/401.2
D743,753 S *	11/2015	James	D7/645
D897,787 S *	10/2020	Ferrell	D7/644

* cited by examiner

Primary Examiner — Ricky Pham

(74) *Attorney, Agent, or Firm* — Young Basile Hanlon &
MacFarlane, P.C.

(57) **CLAIM**

The ornamental design for an eating utensil, as shown and
described.

DESCRIPTION

FIG. 1 is a top, front, right perspective view of an eating
utensil showing my new design.

FIG. 2 is a bottom, front, right perspective view of the eating
utensil of FIG. 1.

FIG. 3 is top plan view of the eating utensil of FIG. 1.

FIG. 4 is a bottom plan view of the eating utensil of FIG. 1.

FIG. 5 is front view of the eating utensil of FIG. 1.

FIG. 6 is right side view of the eating utensil of FIG. 1.

FIG. 7 is rear side view of the eating utensil of FIG. 1; and,
FIG. 8 is left side view of the eating utensil of FIG. 1.

The ornamental design which is claimed is shown in solid
lines in the drawings. The broken lines in the drawings
illustrate unclaimed environmental structure of an eating
utensil and form no part of the claimed design.

1 Claim, 4 Drawing Sheets

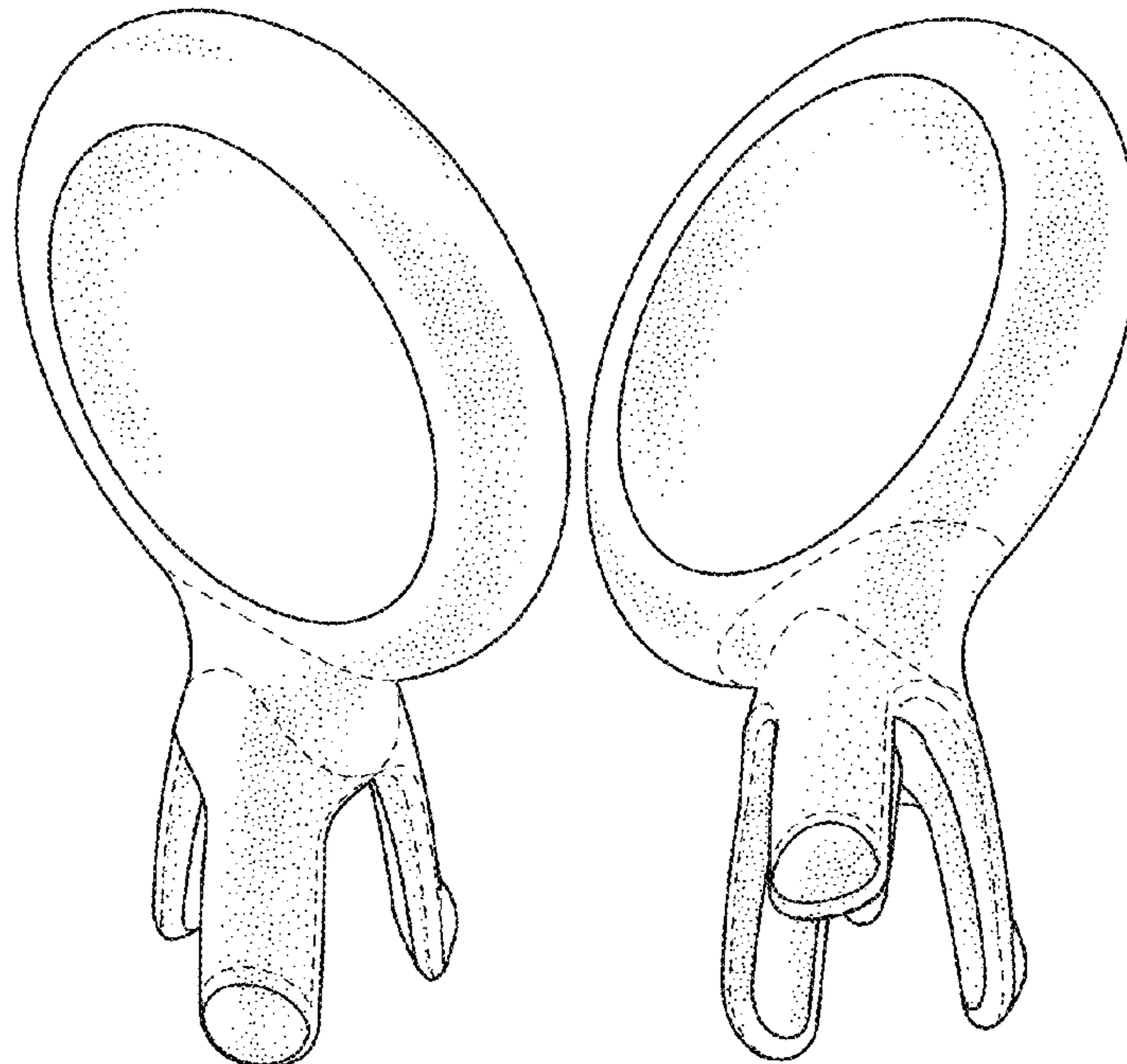

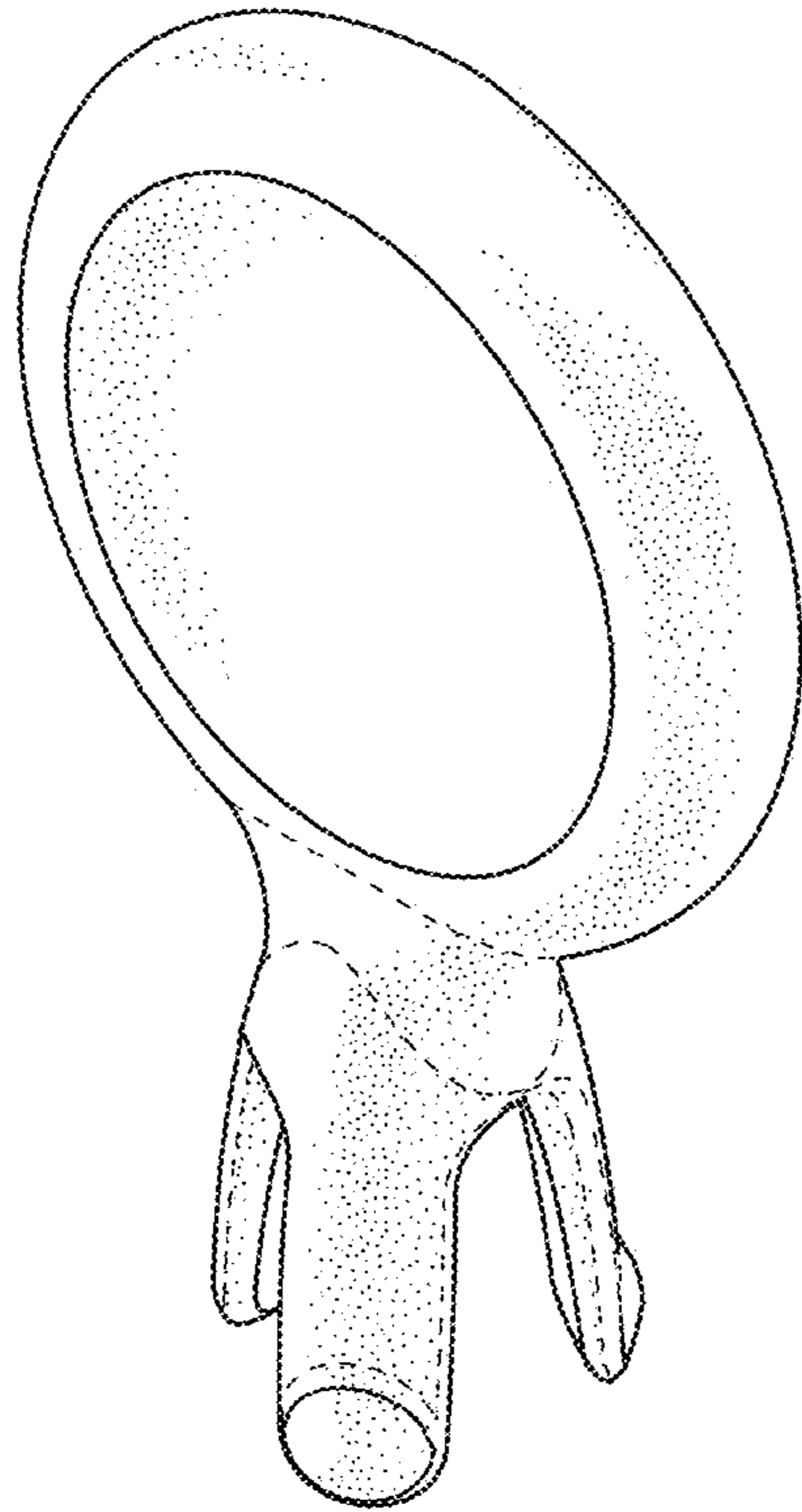

Fig. 1

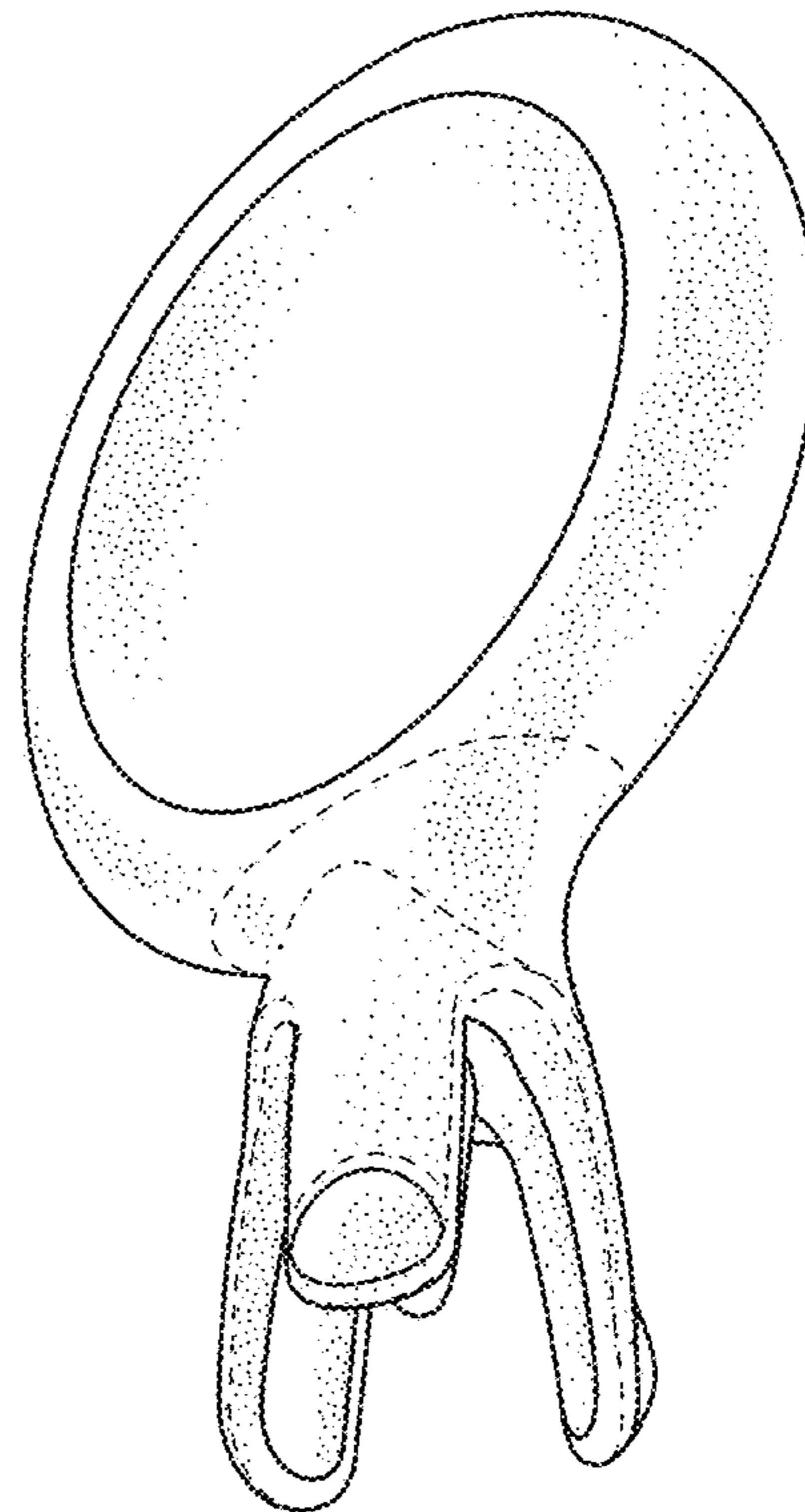

Fig. 2

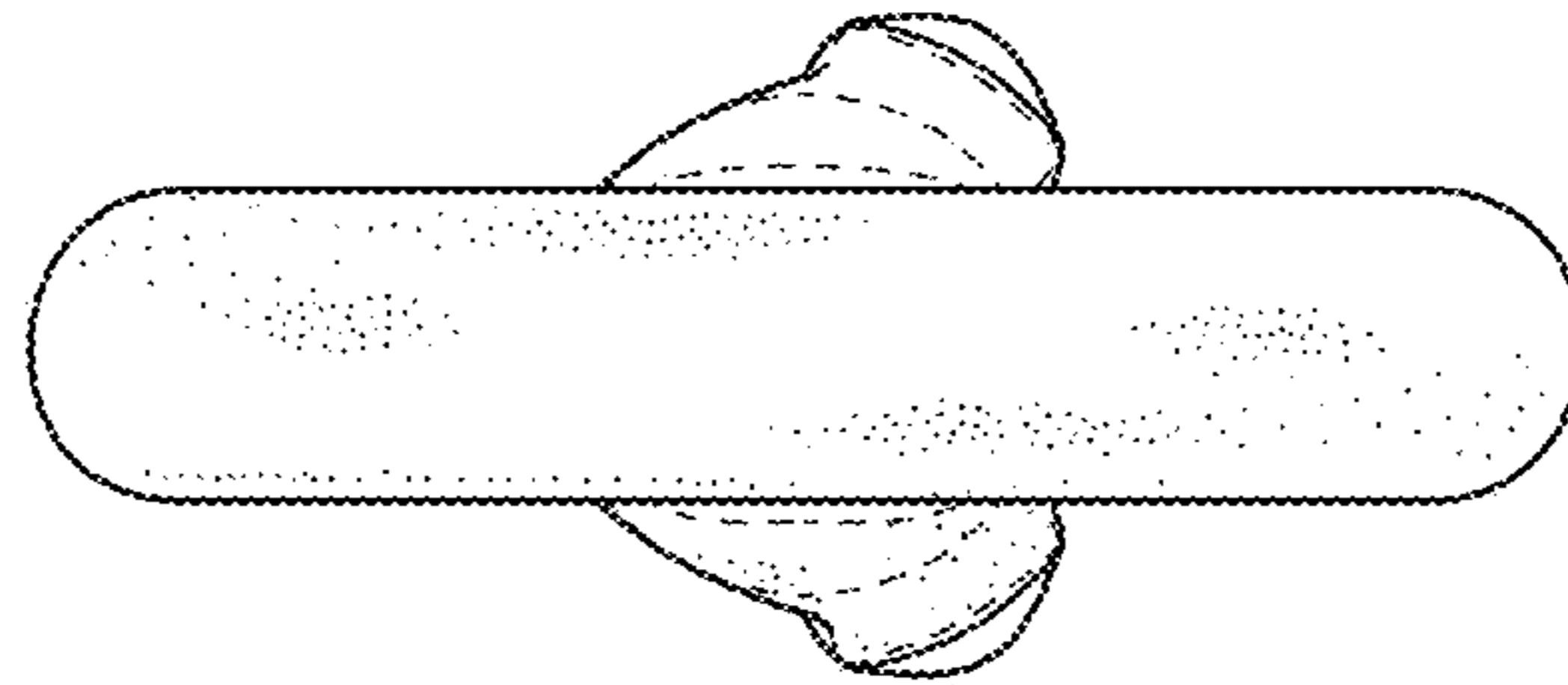

Fig. 3

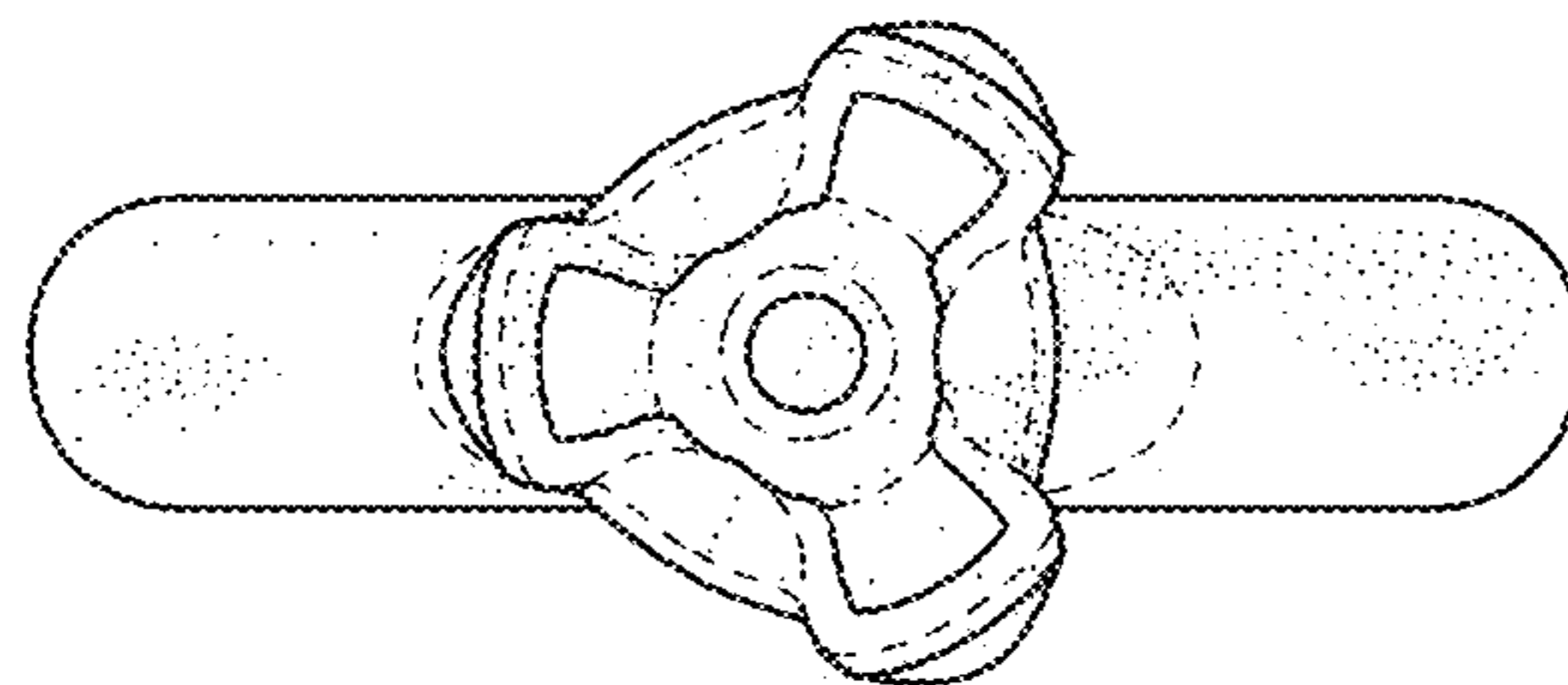

Fig. 4

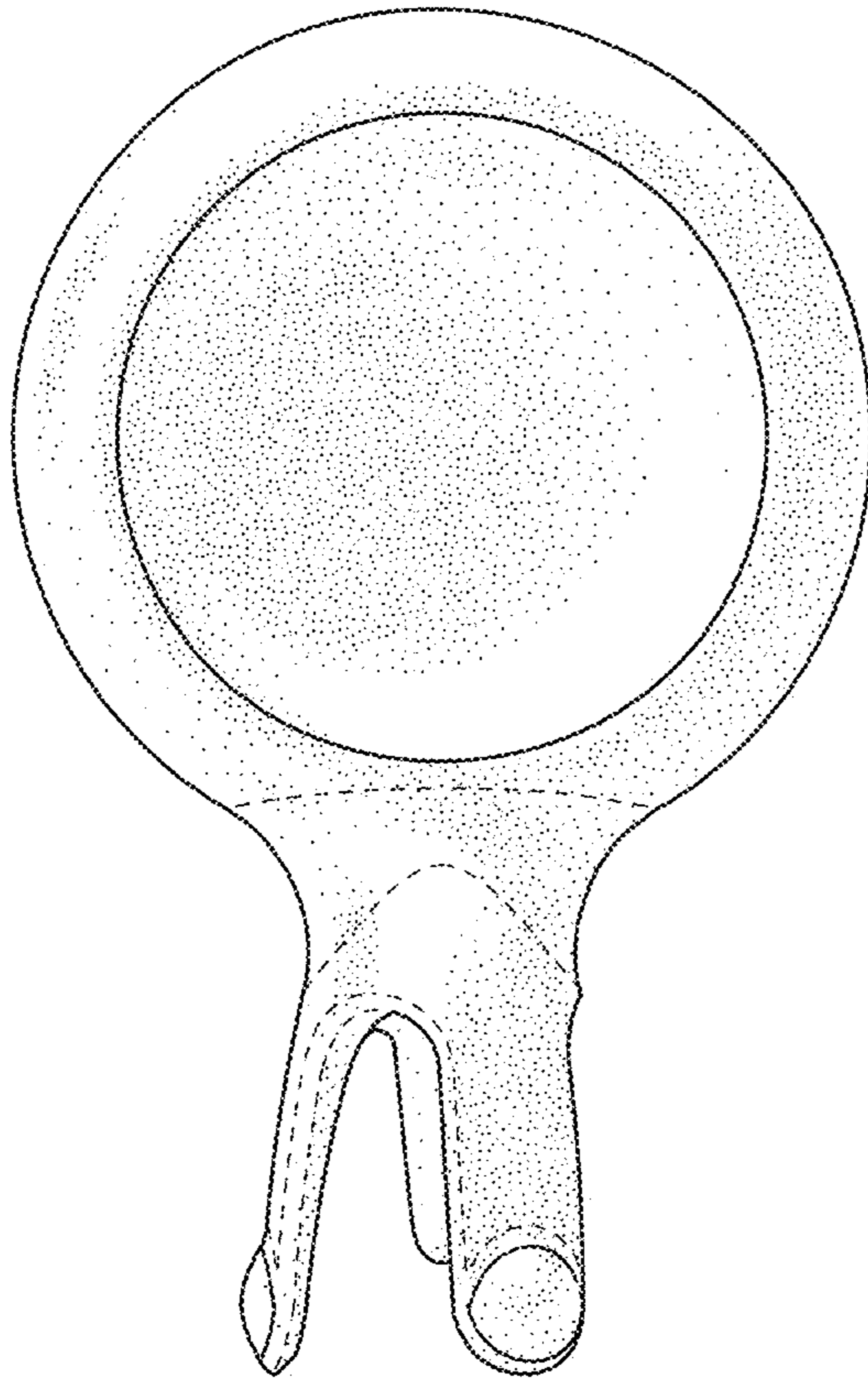

Fig. 5

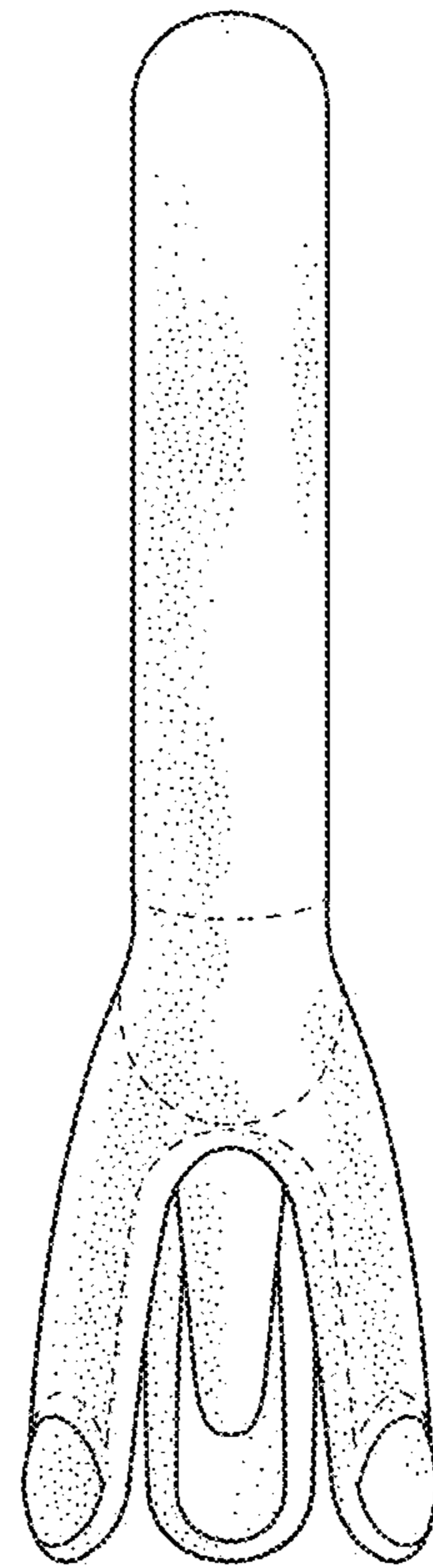

Fig. 6

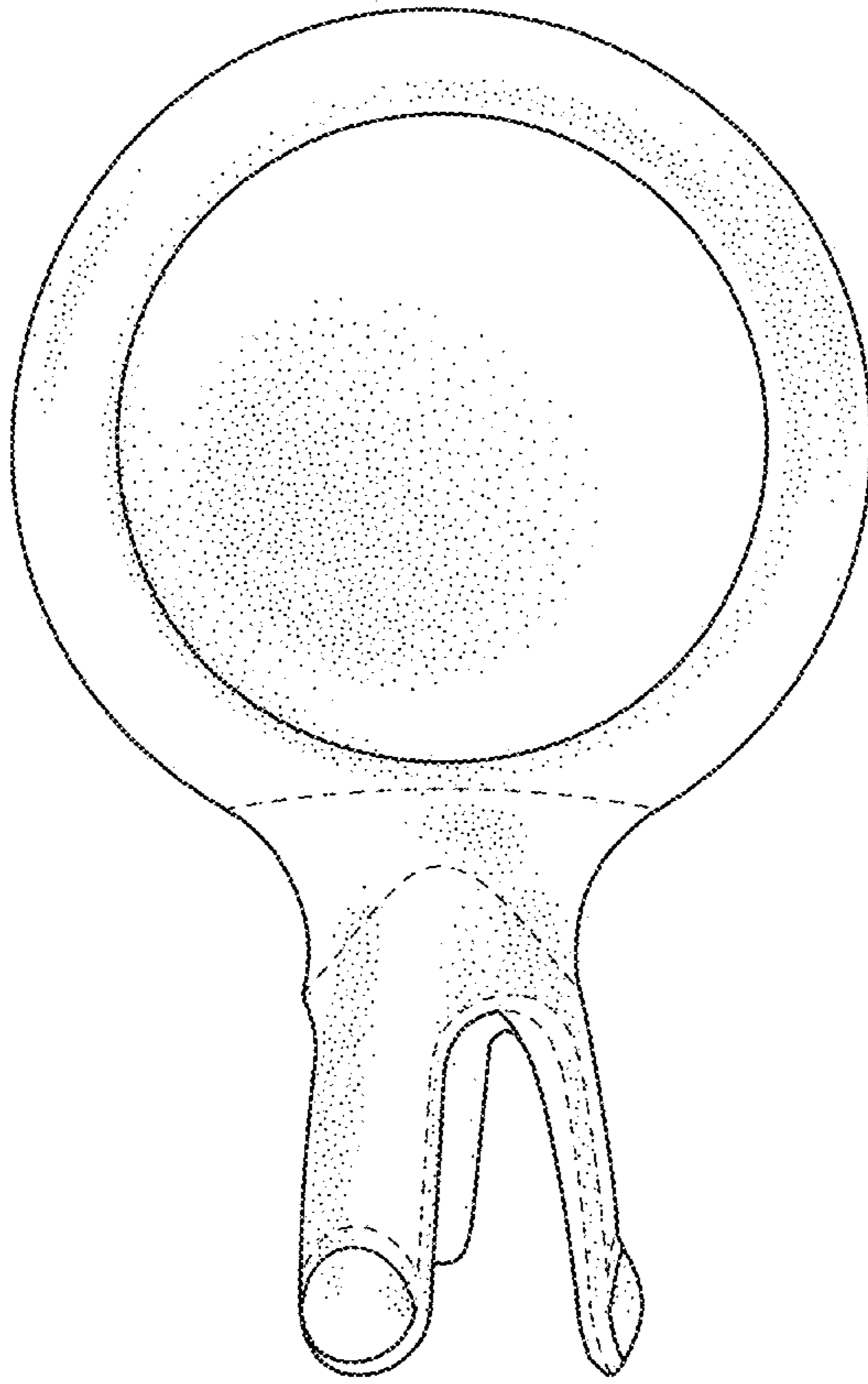

Fig. 7

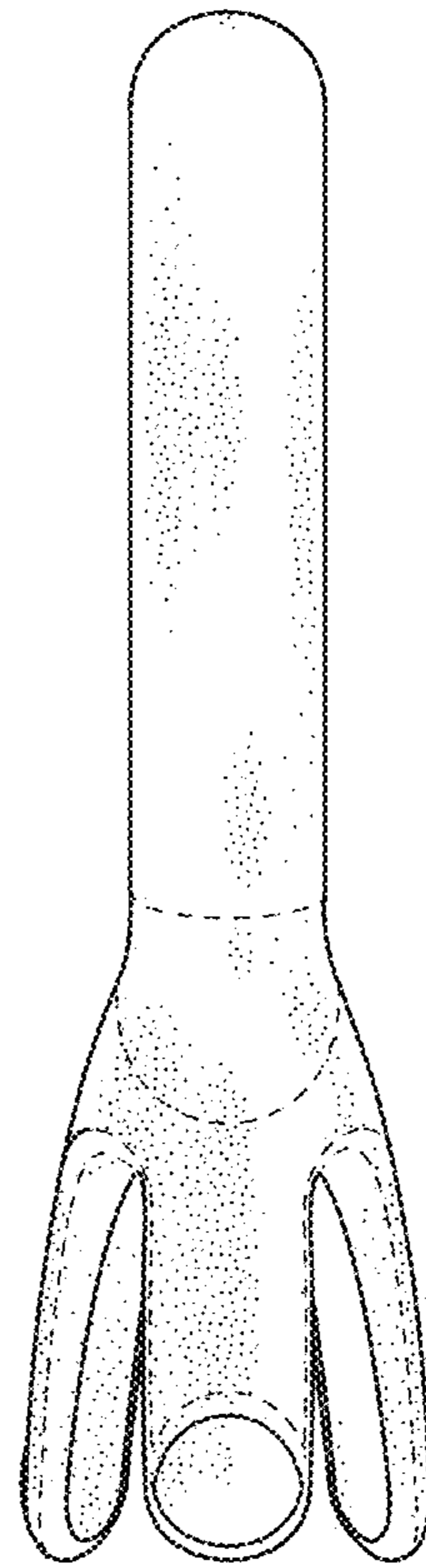

Fig. 8