



US00D915742S

(12) **United States Design Patent**  
**Harvey et al.**

(10) **Patent No.:** **US D915,742 S**

(45) **Date of Patent:** **\*\* Apr. 13, 2021**

- (54) **SHOULDER AND LAP BURP PAD**
- (71) Applicants: **Barbara Elizabeth Harvey**, Atlanta, GA (US); **Patricia Ann Morgan**, Atlanta, GA (US)
- (72) Inventors: **Barbara Elizabeth Harvey**, Atlanta, GA (US); **Patricia Ann Morgan**, Atlanta, GA (US)
- (\*\*) Term: **15 Years**
- (21) Appl. No.: **29/645,602**
- (22) Filed: **Apr. 27, 2018**
- (51) **LOC (13) Cl.** ..... **02-02**
- (52) **U.S. Cl.**  
USPC ..... **D2/860**
- (58) **Field of Classification Search**  
USPC ..... D2/860, 861, 728, 826  
CPC . A41D 1/215; A41D 1/00; A41D 1/02; A41D 1/20  
See application file for complete search history.

- 5,950,888 A \* 9/1999 Nolan-Brown ..... A42B 1/004  
2/209.13
- D465,901 S \* 11/2002 Miller ..... D2/861
- D482,846 S \* 12/2003 Miller ..... D2/861
- D585,631 S \* 2/2009 Barclay ..... D2/861
- D603,142 S \* 11/2009 Wright ..... D2/860
- D603,583 S \* 11/2009 Wood ..... D2/860

(Continued)

**OTHER PUBLICATIONS**

Contoured Burp Cloth Tutorial posted by Slip-Not, posted date Oct. 9, 2013 [site visited Jun. 22, 2020] Available: <<https://slipnotdesigns.wordpress.com/2013/10/09/contoured-burp-cloth-tutorial/>> (Year: 2013).\*

(Continued)

*Primary Examiner* — Kevin K Rudzinski  
(74) *Attorney, Agent, or Firm* — Quickpatents, LLC; Kevin Prince

(57) **CLAIM**

We claim the ornamental design for a shoulder and lap burp pad, as shown and described.

**DESCRIPTION**

FIG. 1 is a perspective view of a shoulder and lap burp pad, showing our new design in a flat configuration; FIG. 2 is a top platy view of FIG. 1, the bottom plan view being a mirror image thereof; FIG. 3 is a right-side elevational view of FIG. 1; FIG. 4 is a left-side elevational view of FIG. 1; FIG. 5 is a rear elevational view of FIG. 1; FIG. 6 is a front elevational view of FIG. 1; and, FIG. 7 is a perspective view thereof, illustrated in a rolled and tied configuration. The broken lines showing a portion of the tie strap in FIGS. 1, 2, and 5-7 depict portions of the shoulder and lap burp pad that form no part of the claimed design.

**1 Claim, 4 Drawing Sheets**

- (56) **References Cited**  
U.S. PATENT DOCUMENTS
- 2,727,239 A \* 12/1955 Simon ..... A41B 13/10  
2/49.2
- 2,831,193 A \* 4/1958 Terry ..... A41B 13/10  
2/46
- D299,282 S \* 1/1989 Winans ..... D2/861
- D303,995 S \* 10/1989 Dameron ..... D2/728
- D309,522 S \* 7/1990 Merritt ..... D2/728
- D341,019 S \* 11/1993 Ostrow ..... D2/862
- 5,440,762 A \* 8/1995 Schill ..... A41D 1/215  
2/104
- 5,479,662 A \* 1/1996 Runco ..... A41D 1/215  
2/104
- 5,652,958 A \* 8/1997 Farrell-Mestas ..... A41D 1/215  
2/48
- D392,440 S \* 3/1998 Garza, Jr. .... D2/860
- 5,802,618 A \* 9/1998 Mustata ..... A41D 23/00  
2/207

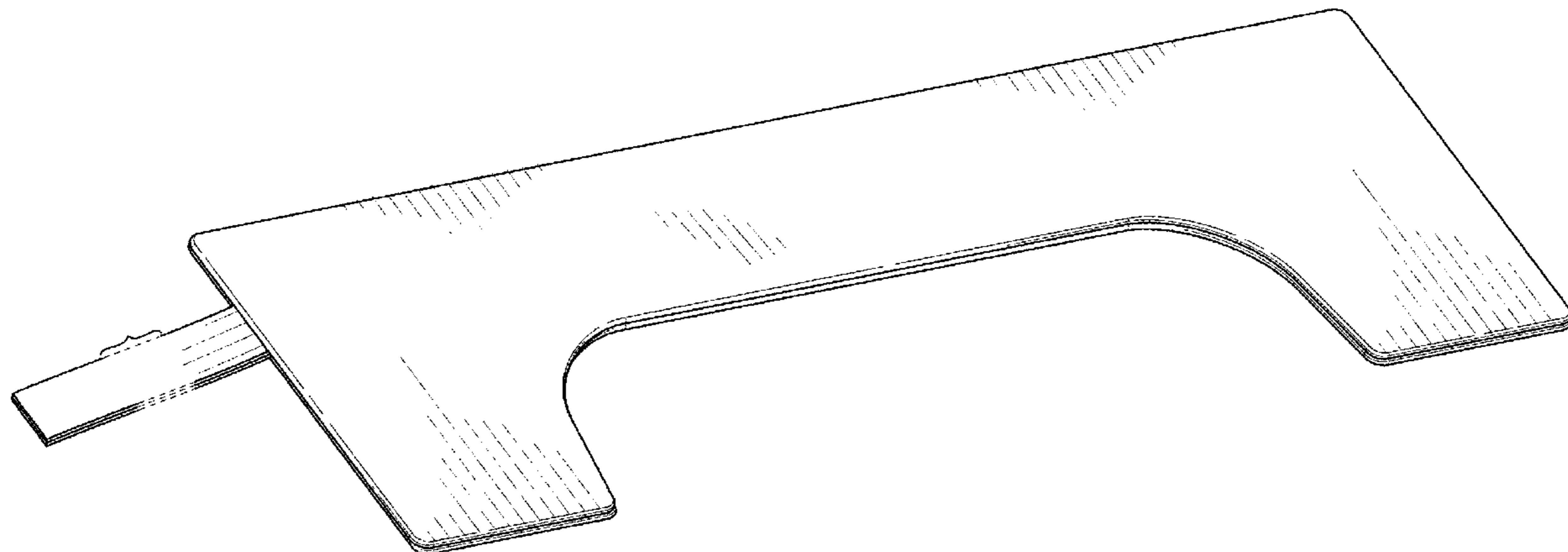

(56)

**References Cited**

U.S. PATENT DOCUMENTS

D650,560 S \* 12/2011 Lupton-Wilkinson ..... D2/860  
D715,519 S \* 10/2014 Dodd ..... D2/860  
D829,414 S \* 10/2018 Dyson ..... D2/860  
10,157,557 B1 \* 12/2018 Martin ..... A47G 9/0223  
2008/0235870 A1 \* 10/2008 Heide ..... A47G 9/068  
5/484  
2016/0066629 A1 \* 3/2016 Marcum ..... A41B 13/10  
2/46

OTHER PUBLICATIONS

Baby Gift Tutorial: Minky Burp Cloth posted by Abbey on  
onlinefabricstore.net. posted date: Feb. 25, 2014 [site visited Jun.  
22, 2020] Available: <<https://www.onlinefabricstore.net/blog/baby-gift-tutorial-minky-burp-cloth/>> (Year: 2014).\*

Tutorial—Contoured Burp Cloths, posted to cloud9fabrics.com.  
Available date: Dec. 8, 2010 [site visited Dec. 7, 2020] Available:  
<<https://cloud9fabrics.com/tutorial-contoured-burp-cloths/>> (Year:  
2010).\*

\* cited by examiner

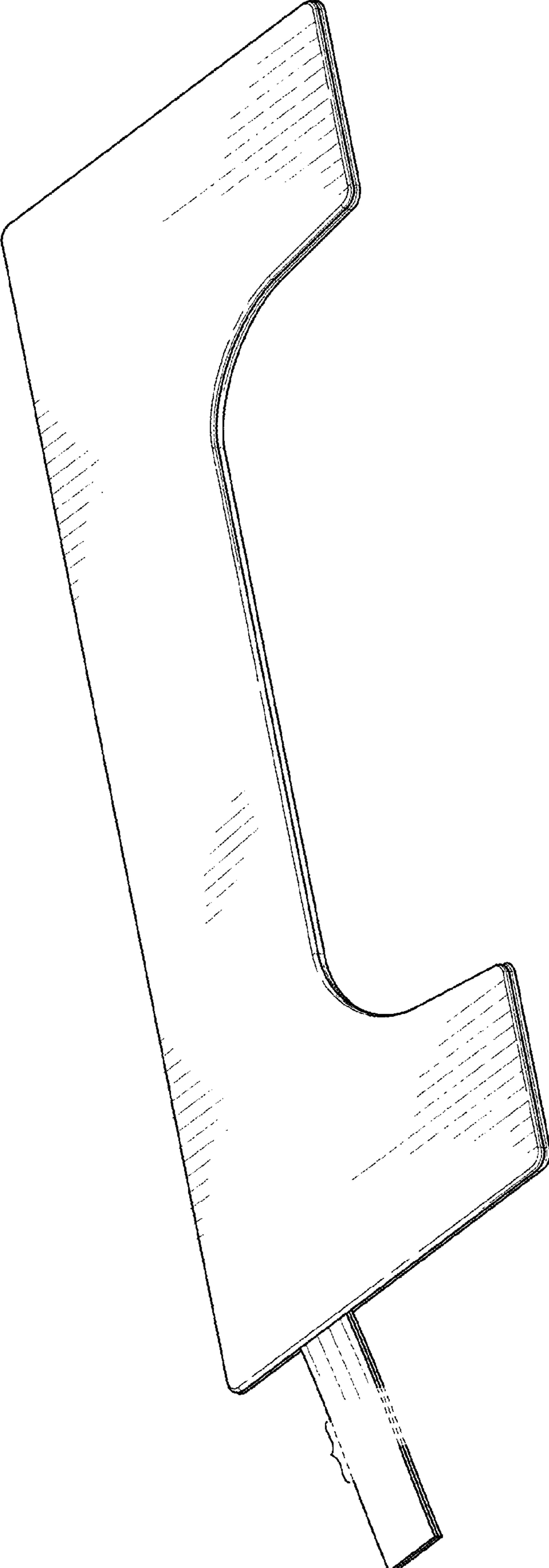

FIG. 1

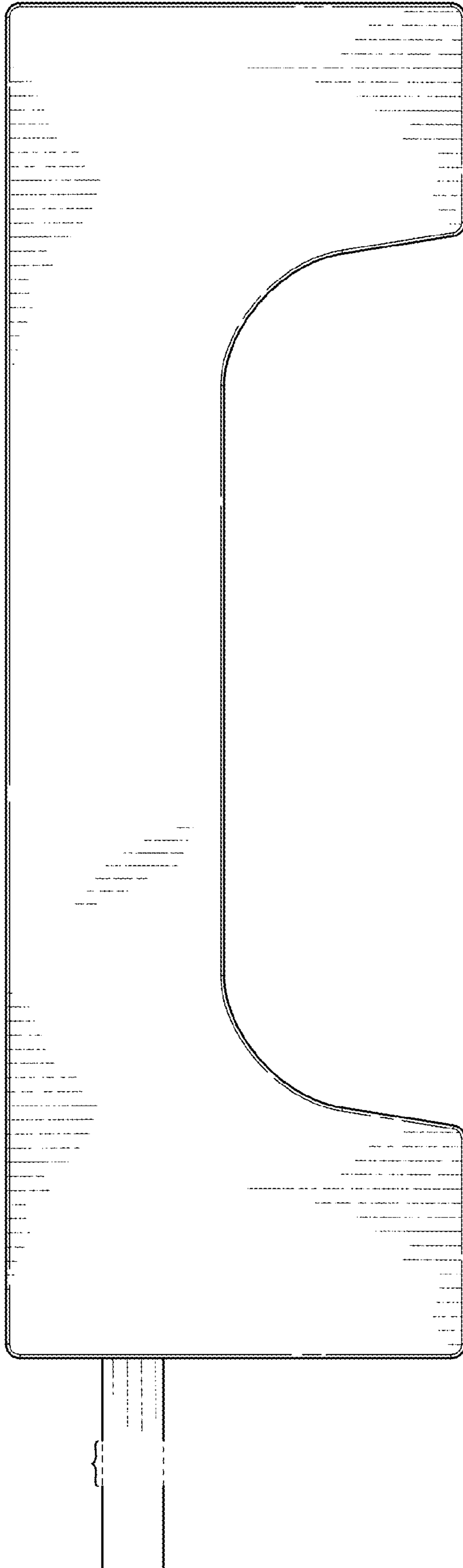

FIG. 2

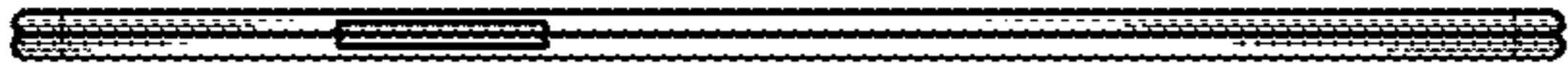

FIG. 4

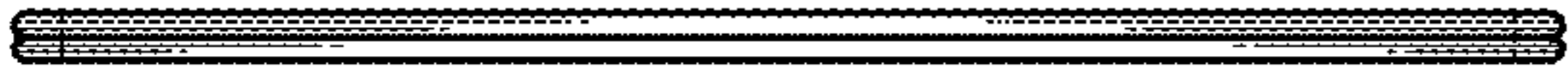

FIG. 3



FIG. 5



FIG. 6

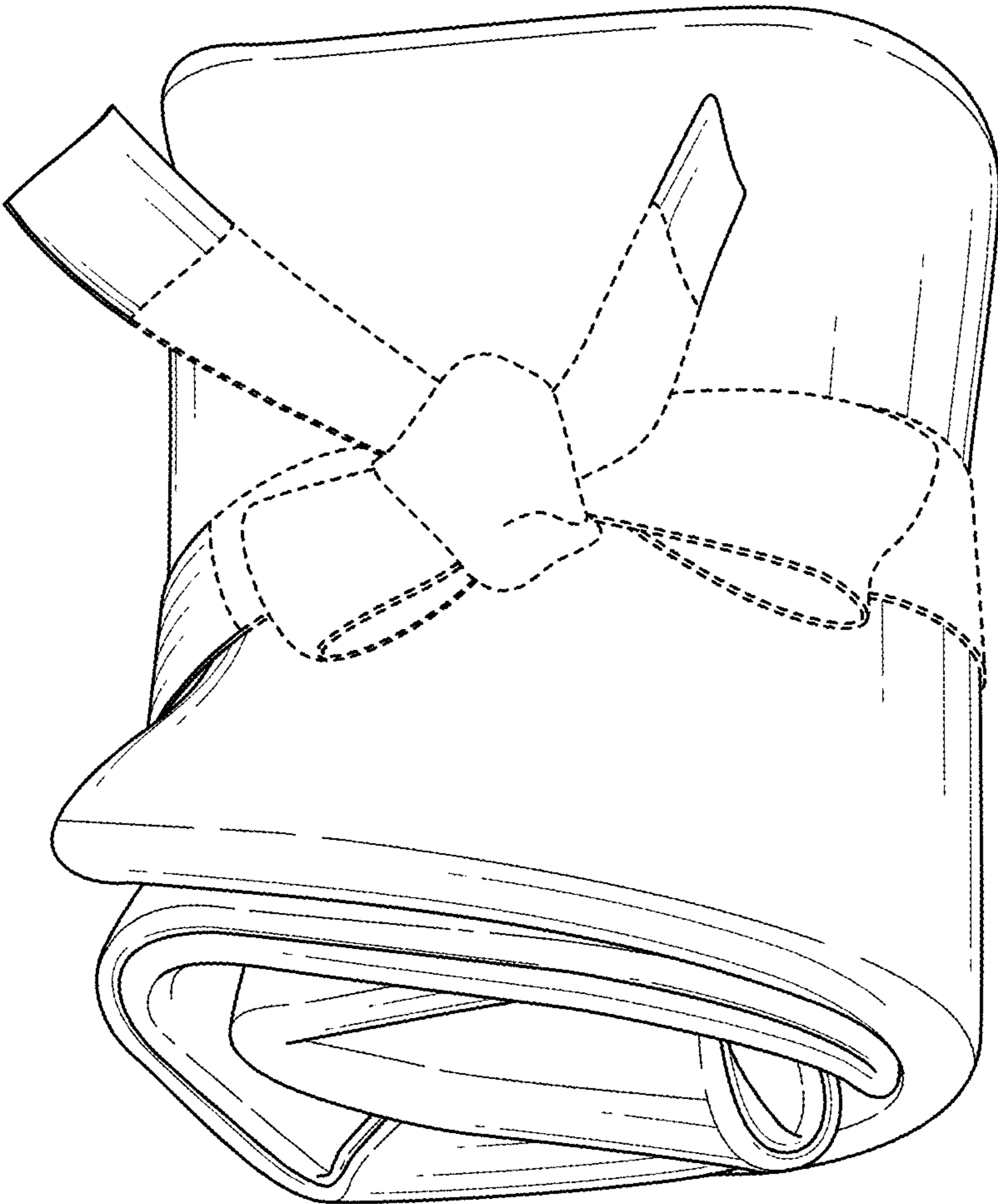

FIG. 7

UNITED STATES PATENT AND TRADEMARK OFFICE  
**CERTIFICATE OF CORRECTION**

PATENT NO. : D915,742 S  
APPLICATION NO. : 29/645602  
DATED : April 13, 2021  
INVENTOR(S) : Harvey et al.

Page 1 of 1

It is certified that error appears in the above-identified patent and that said Letters Patent is hereby corrected as shown below:

On the Title Page

Column 2, under 'Description', Line 3, delete "platy" and insert -- plan --, therefor.

Signed and Sealed this  
Sixteenth Day of August, 2022  
  
Katherine Kelly Vidal  
*Director of the United States Patent and Trademark Office*