



US00D915718S

(12) **United States Design Patent** (10) **Patent No.:** **US D915,718 S**
Li (45) **Date of Patent:** **** Apr. 6, 2021**

(54) **CART WITH SHELF**

(71) Applicant: **Kewen Li**, Nanning (CN)

(72) Inventor: **Kewen Li**, Nanning (CN)

(**) Term: **15 Years**

(21) Appl. No.: **29/752,479**

(22) Filed: **Sep. 28, 2020**

(51) **LOC (13) Cl.** **12-02**

(52) **U.S. Cl.**
USPC **D34/21**

(58) **Field of Classification Search**
USPC D34/12-27

CPC B62B 1/112; B62B 1/006; B62B 1/262;
B62B 1/264; B62B 1/14; B62B 1/125;
B62B 3/002; B62B 3/005; B62B 3/027;
B62B 3/1408; B62B 3/146; B62B 3/142;
B62B 3/02; B62B 3/10; B62B 3/12;
B62B 3/14; B62B 3/1492; B62B 3/165;
B62B 5/06; B62B 5/067

See application file for complete search history.

(56) **References Cited**

U.S. PATENT DOCUMENTS

D303,444 S * 9/1989 Yoshikawa D34/21
D436,239 S * 1/2001 Walsh D34/17
6,460,950 B2 10/2002 Spitzer
D485,107 S 1/2004 Sung
D608,970 S * 1/2010 Cordeiro D34/16
D636,550 S * 4/2011 Molayem D34/21

D703,412 S * 4/2014 Snider D34/21
D752,906 S * 4/2016 Gunderson D6/675.1
D831,292 S * 10/2018 Thuma D34/12
D846,824 S * 4/2019 Cao D34/21
D901,123 S * 11/2020 Liu D34/21
D901,817 S * 11/2020 Li D34/21

* cited by examiner

Primary Examiner — Cynthia Ramirez

(57) **CLAIM**

The ornamental design for a cart with shelf, as shown and described.

DESCRIPTION

FIG. 1 is a perspective view of a cart with shelf showing my new design;
FIG. 2 is another perspective view thereof;
FIG. 3 is a front elevational view thereof;
FIG. 4 is a rear elevational view thereof;
FIG. 5 is a left side elevational view thereof;
FIG. 6 is a right side elevational view thereof;
FIG. 7 is a top plan view thereof;
FIG. 8 is a bottom plan view thereof; and,
FIG. 9 is an enlarged view of portion 9 shown in FIG. 1.
The broken lines in the figures shown portions of the cart with shelf which form no part of the claimed design. The dash-dot broken lines are to show enlarged areas.

1 Claim, 9 Drawing Sheets

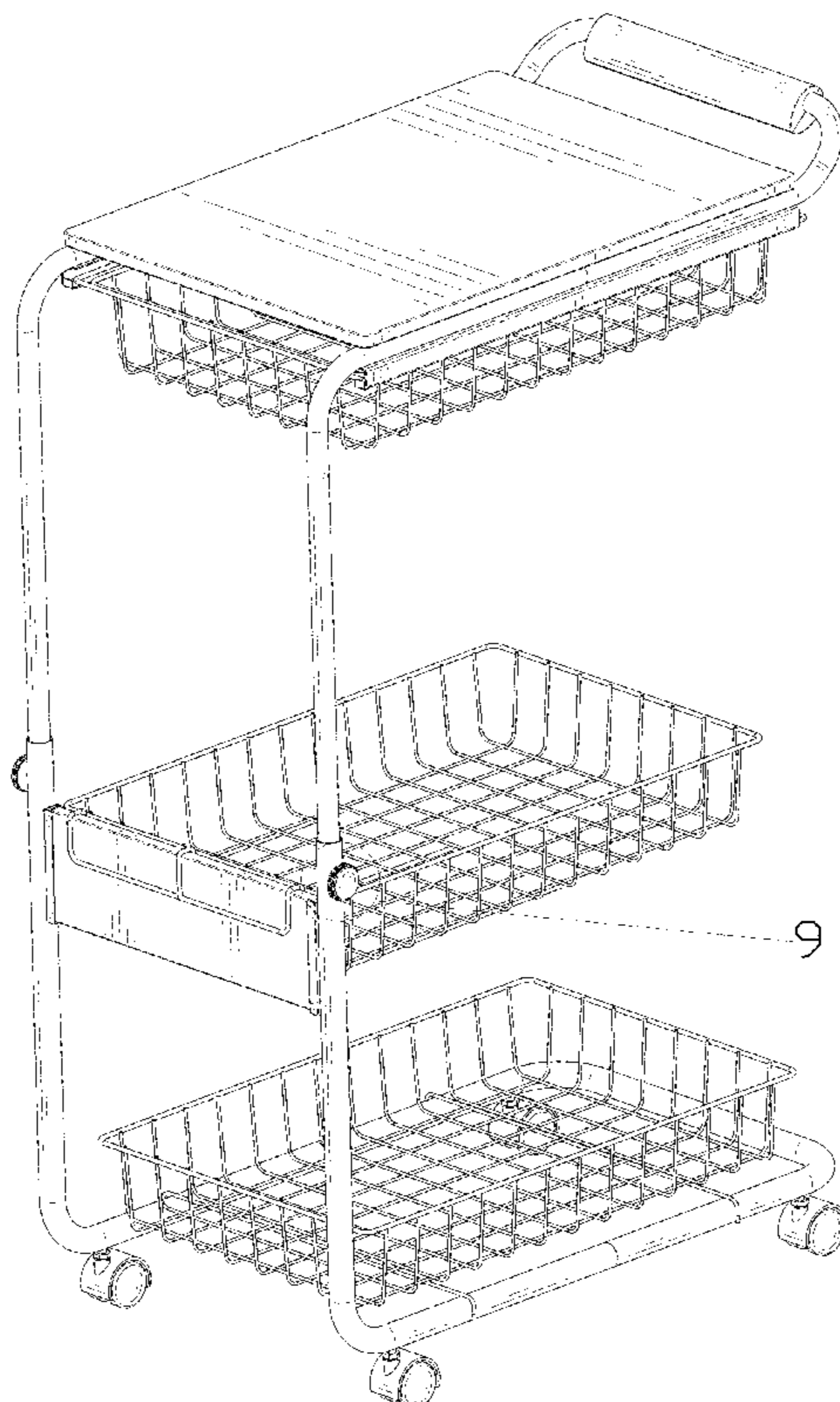

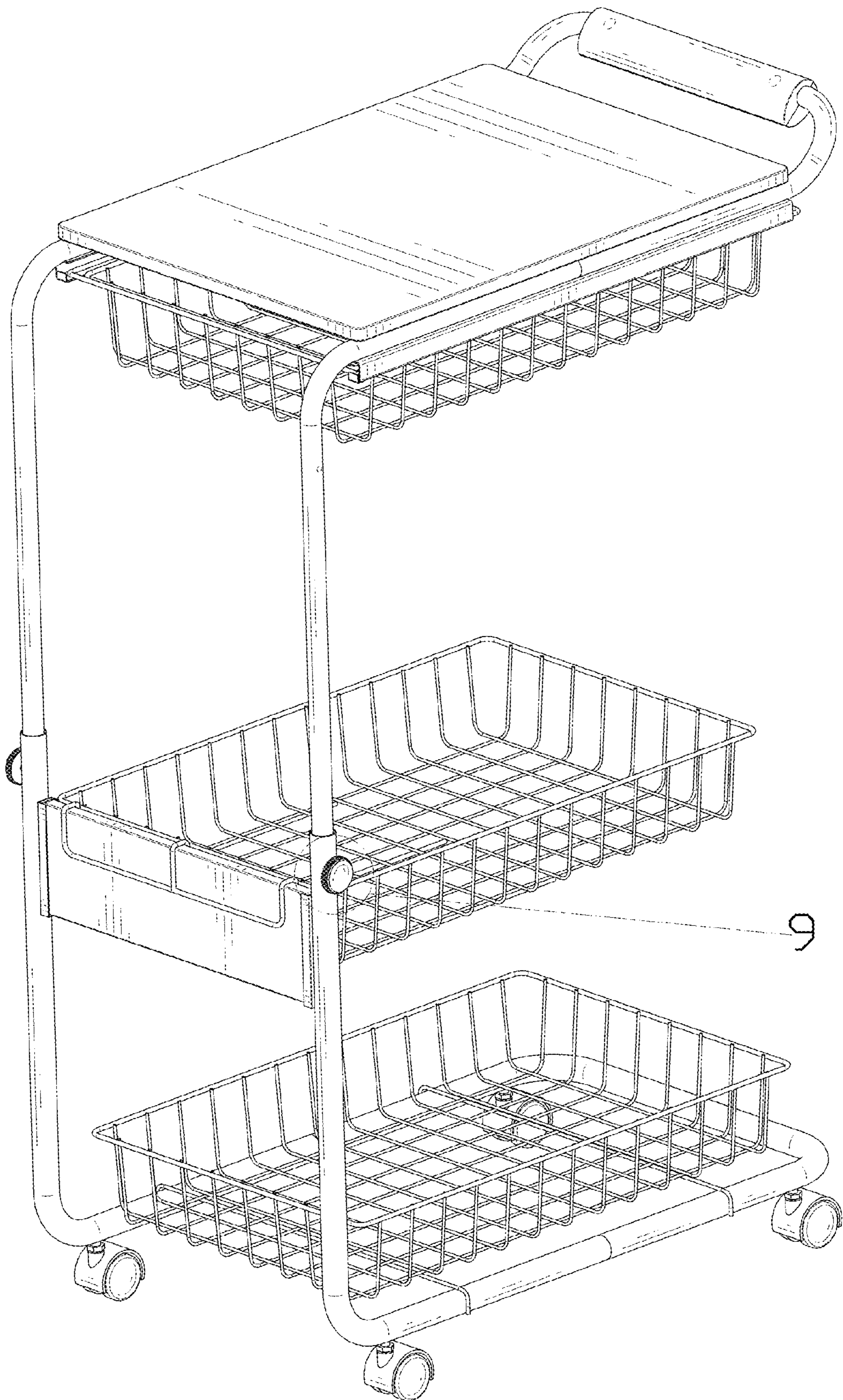

FIG. 1

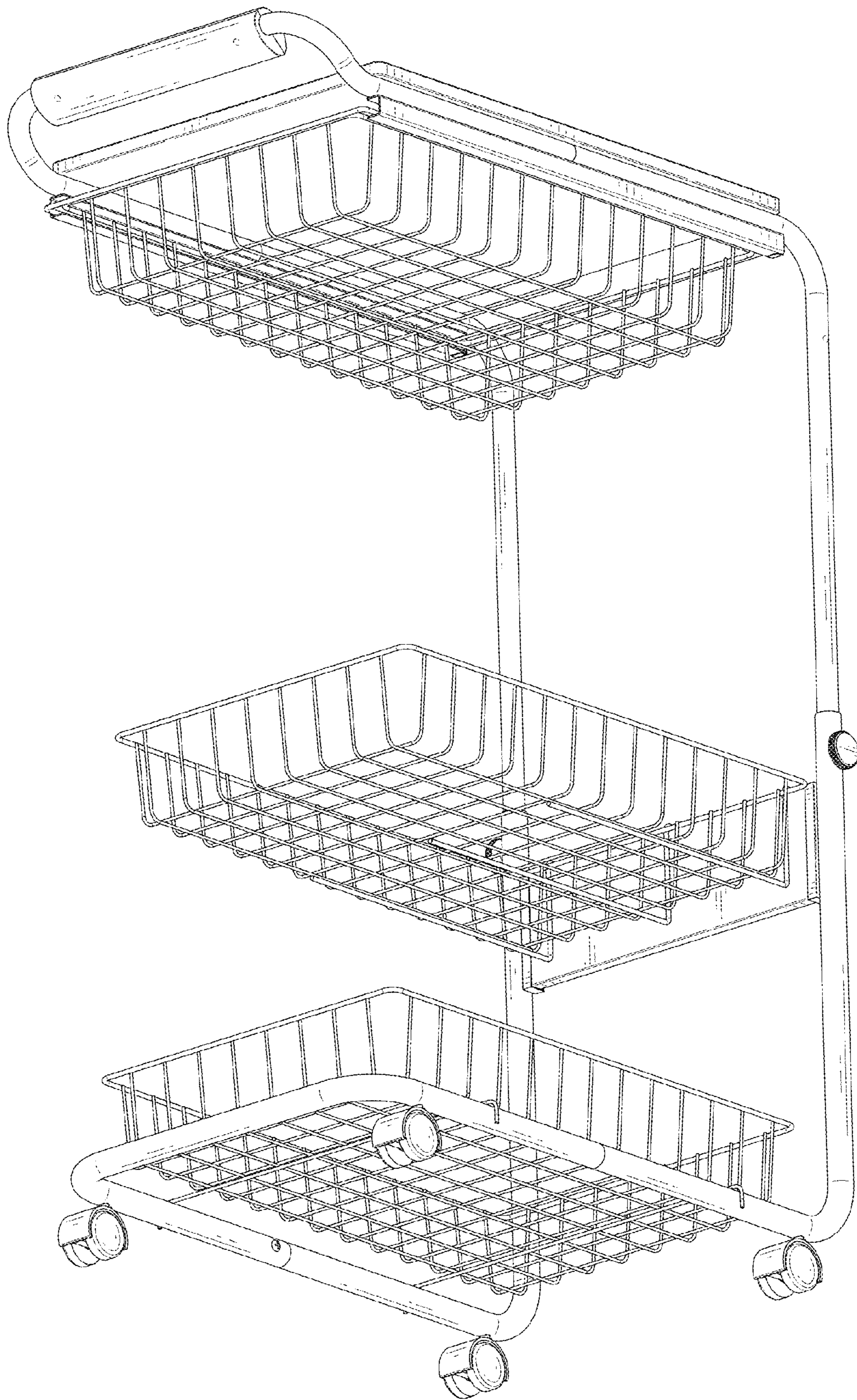

FIG. 2

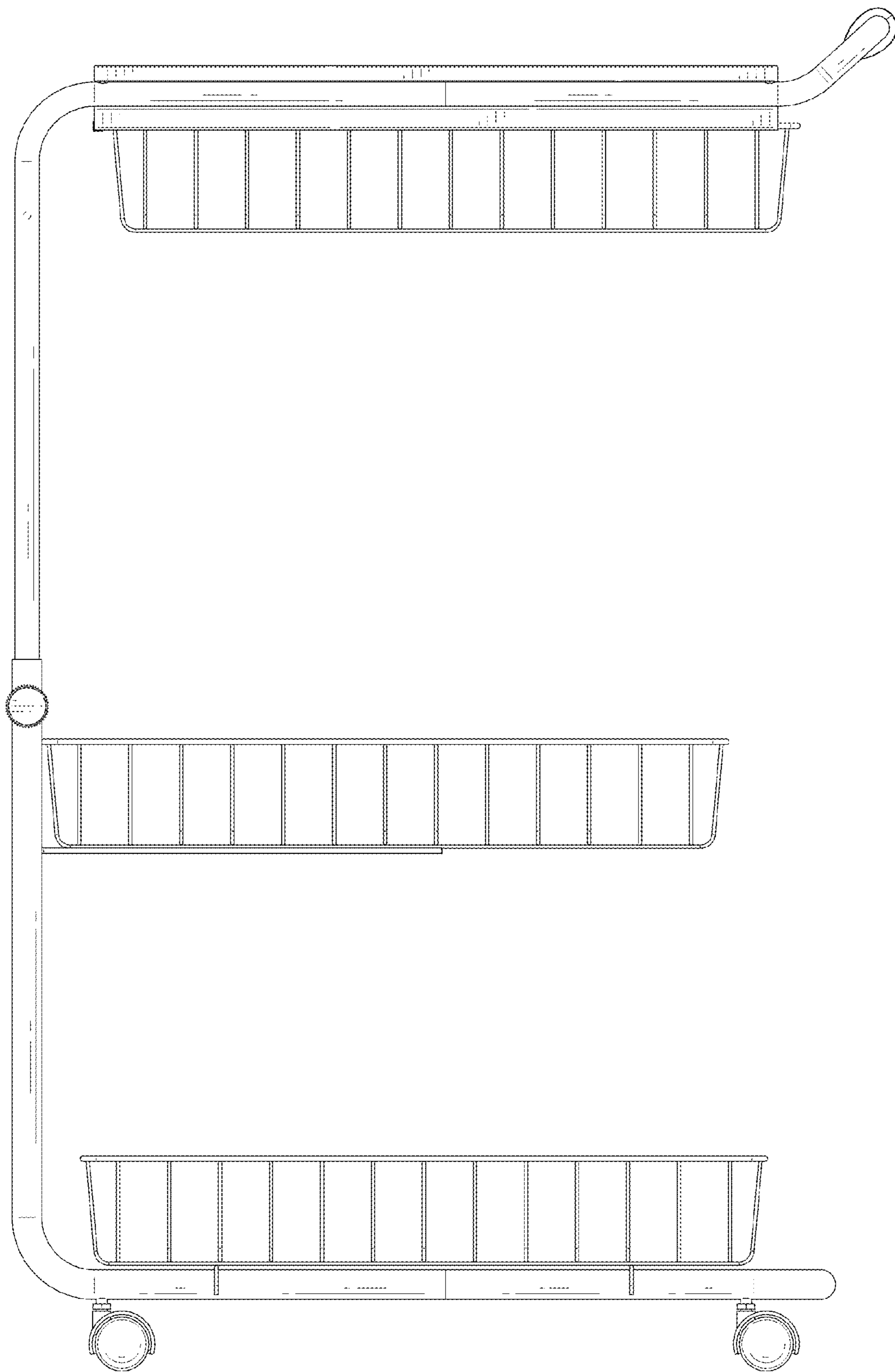

FIG. 3

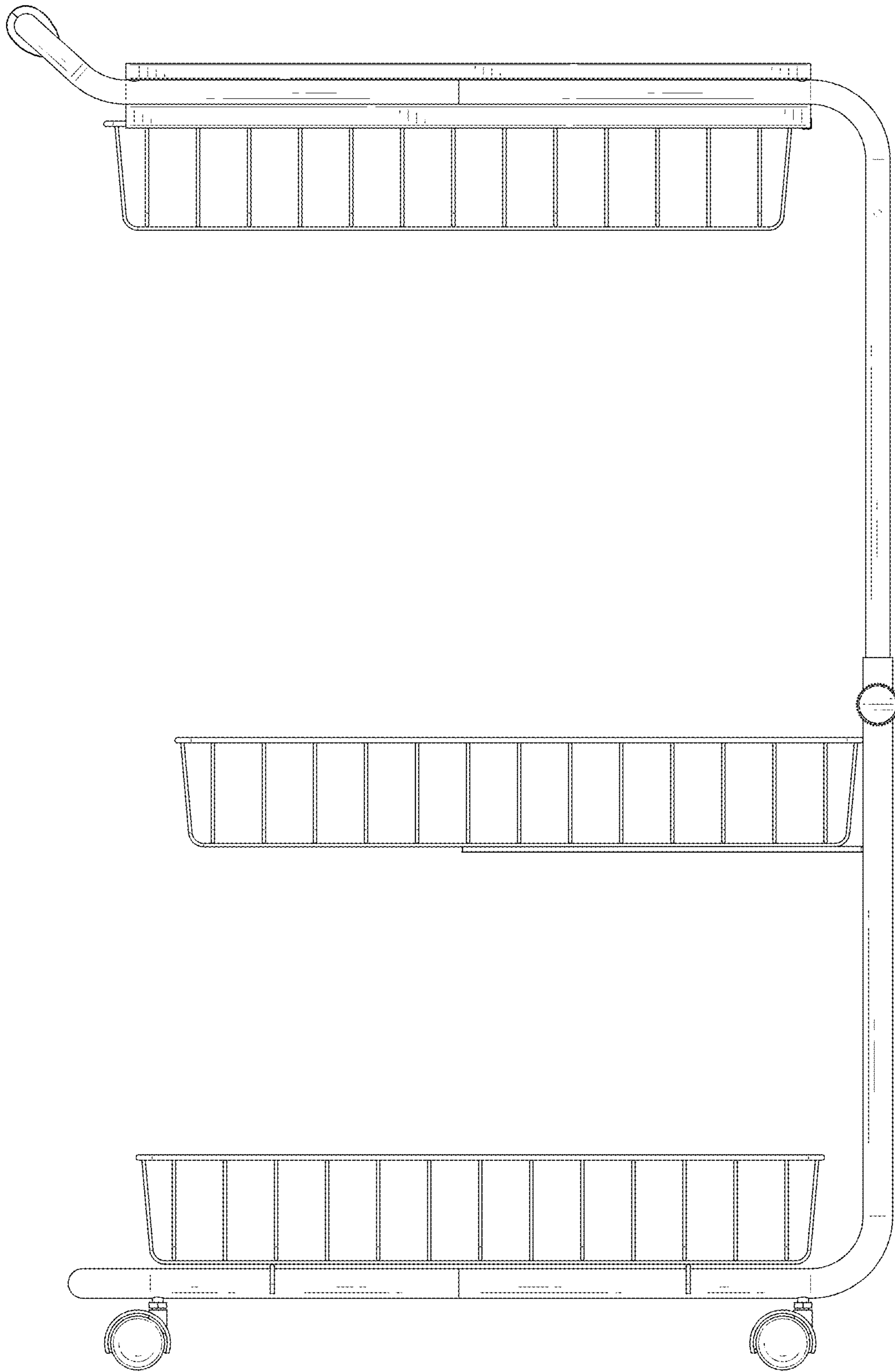

FIG. 4

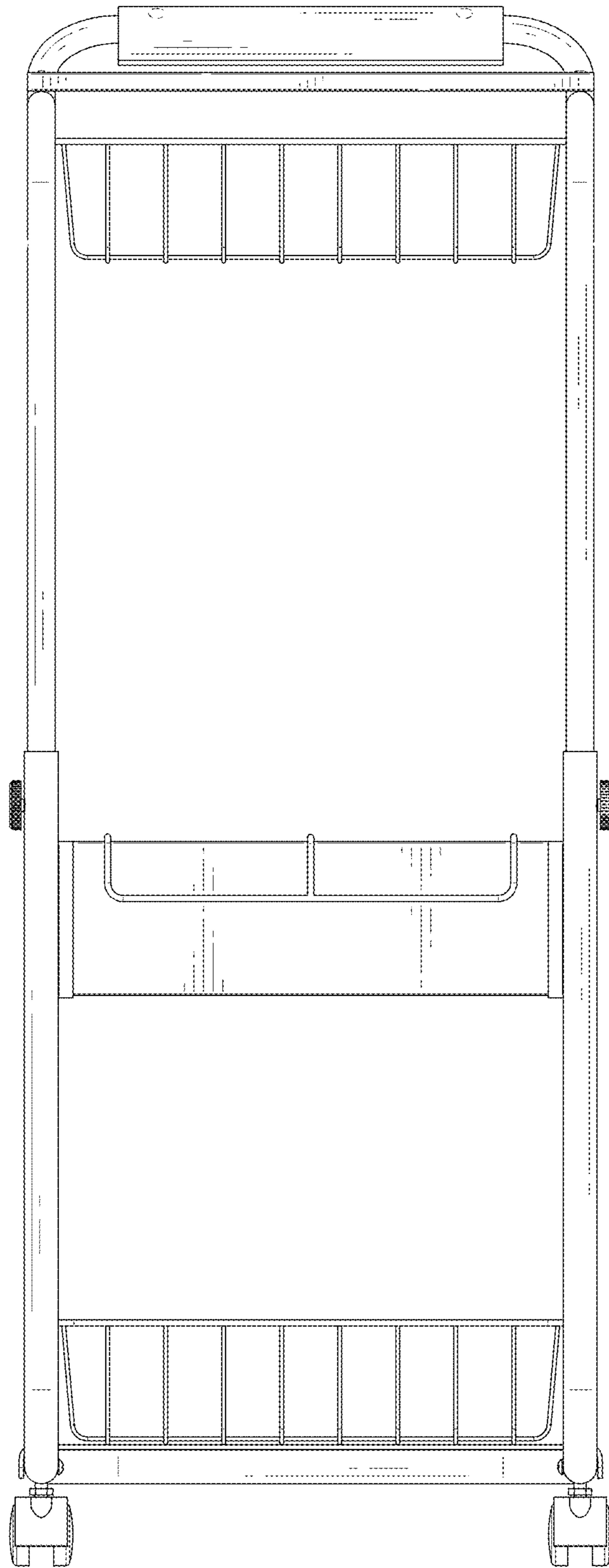

FIG. 5

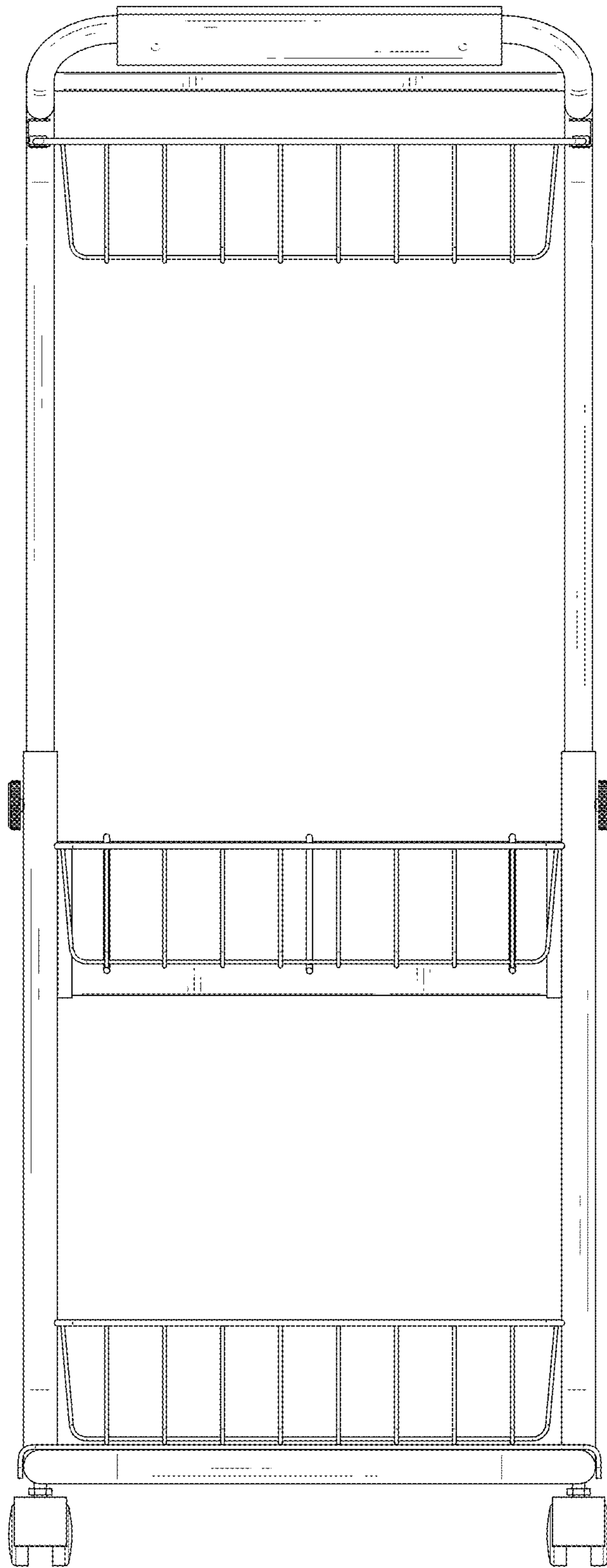

FIG. 6

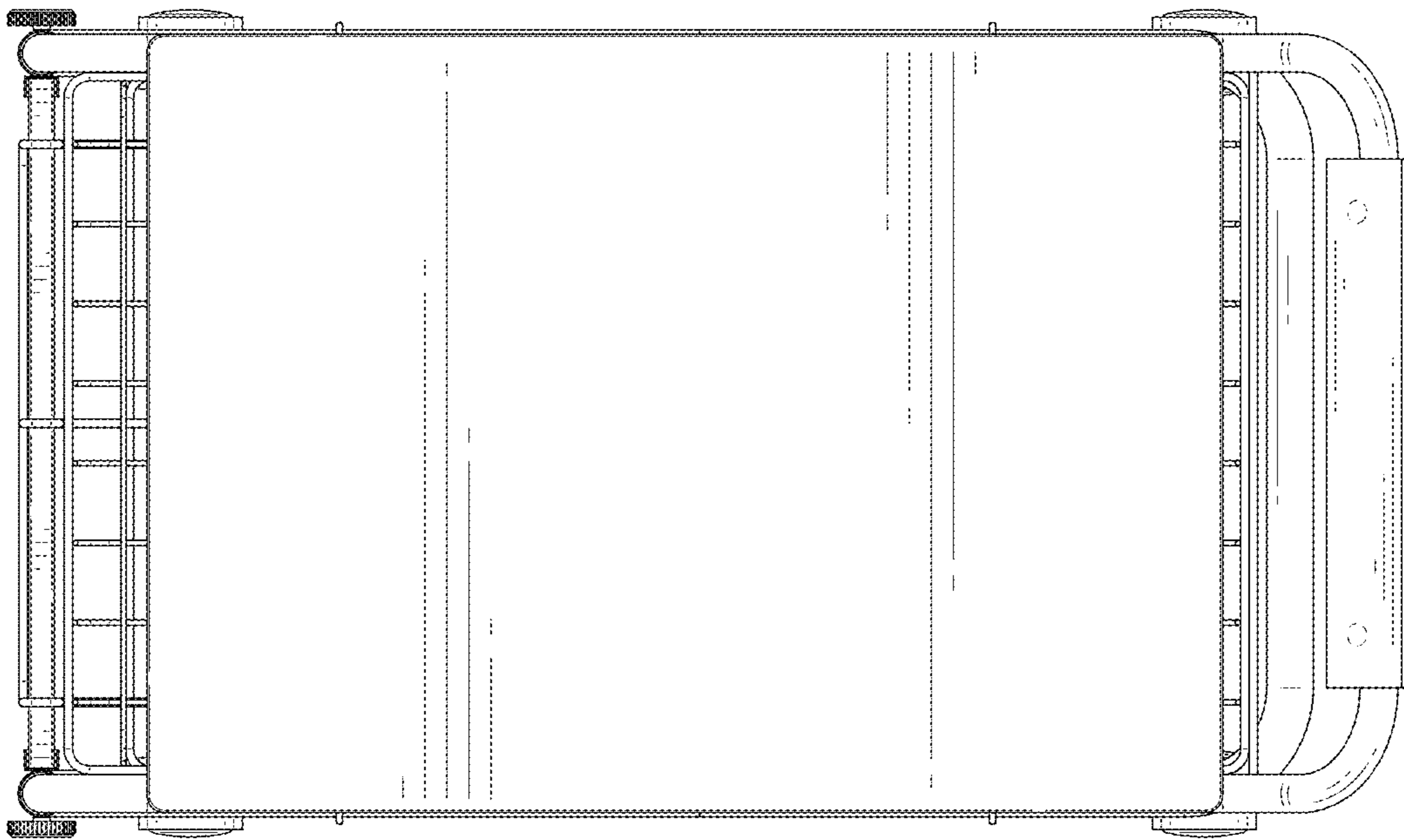

FIG. 7

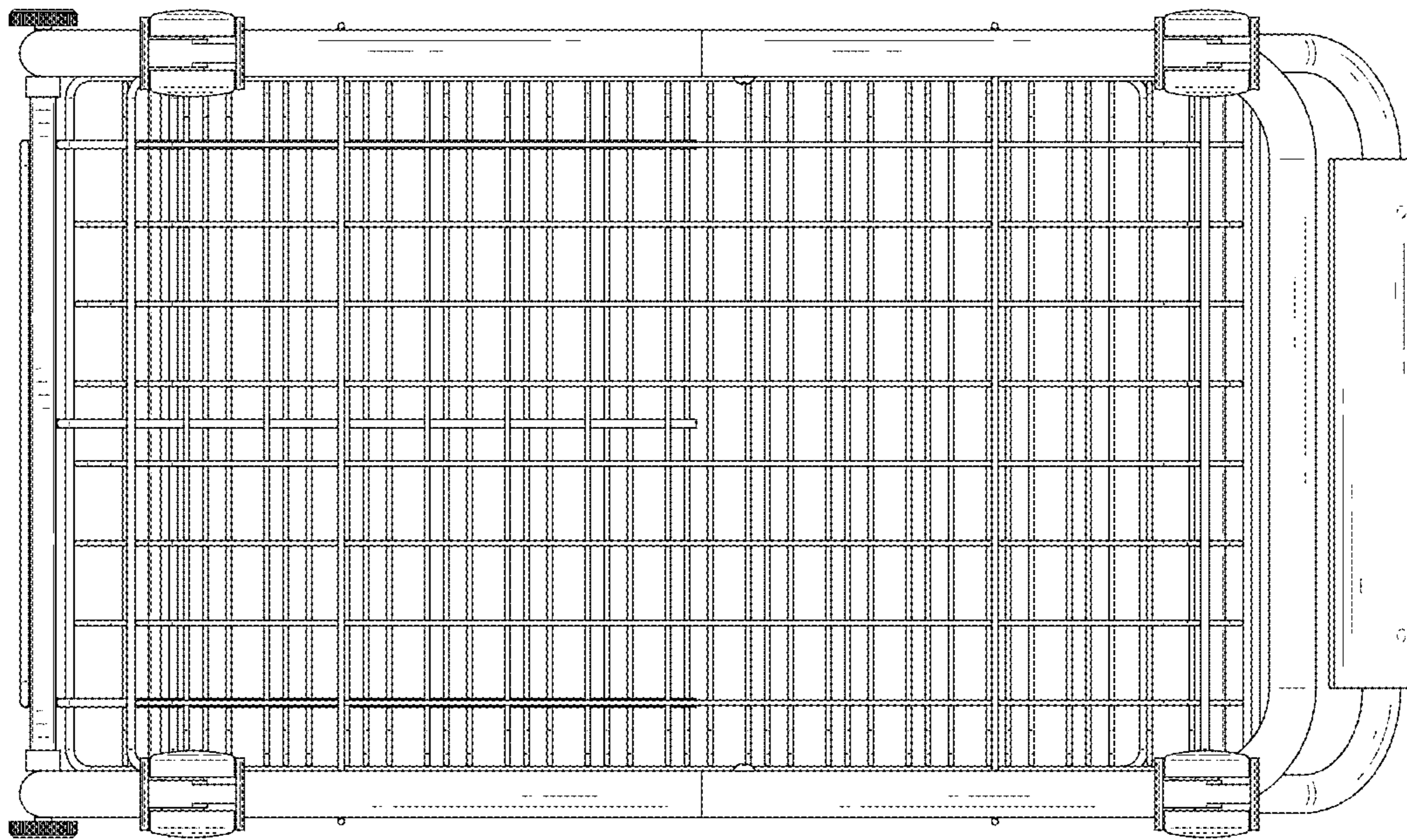

FIG. 8

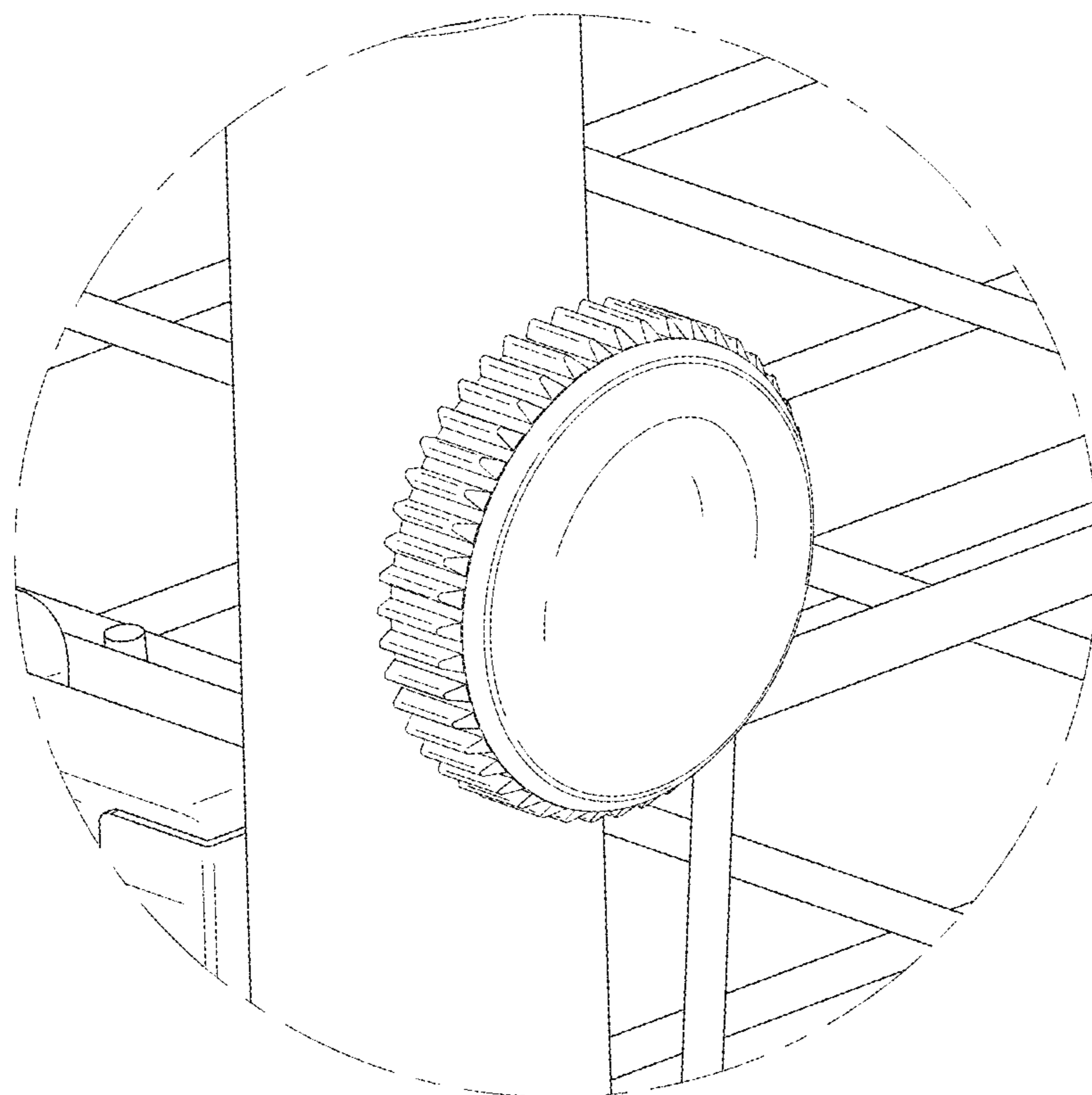

FIG. 9