

US00D915712S

(12) **United States Design Patent** (10) **Patent No.:** **US D915,712 S**  
**Liu** (45) **Date of Patent:** **\*\* Apr. 6, 2021**

(54) **DUSTBIN**  
(71) Applicant: **Guangzhou Homfel Ltd.**, Guangdong (CN)  
(72) Inventor: **Martin Liu**, Guangdong (CN)  
(73) Assignee: **GUANGZHOU HOMFEL LTD.**, Guangdong (CN)  
(\*\*) Term: **15 Years**  
(21) Appl. No.: **29/711,768**  
(22) Filed: **Nov. 1, 2019**  
(30) **Foreign Application Priority Data**

Sep. 9, 2019 (CN) ..... 201930493701.7  
(51) **LOC (13) Cl.** ..... **09-09**  
(52) **U.S. Cl.**  
USPC ..... **D34/9**  
(58) **Field of Classification Search**  
USPC ..... D34/1, 7, 8, 9, 10, 11  
CPC ..... B65F 1/06; B65F 1/067; B65F 1/1607;  
B65F 1/163; B65F 1/062; B65F 1/1623  
See application file for complete search history.

(56) **References Cited**  
U.S. PATENT DOCUMENTS  
D841,275 S \* 2/2019 Chen ..... D34/9  
D842,573 S \* 3/2019 Smeets ..... D34/9

D853,067 S \* 7/2019 Chen ..... D34/9  
D905,367 S \* 12/2020 Smeets ..... D34/9  
D906,620 S \* 12/2020 Tan ..... D34/8  
2013/0105486 A1 \* 5/2013 Mashburn ..... B65F 1/08  
220/495.06  
2019/0152696 A1 \* 5/2019 Wegner ..... B65F 1/1646

\* cited by examiner

*Primary Examiner* — Cynthia Ramirez  
(74) *Attorney, Agent, or Firm* — D'Ambrosio & Menon, PLLC; Usha Menon

(57) **CLAIM**

The ornamental design for a dustbin, as shown and described.

**DESCRIPTION**

FIG. 1 is a front view of a dustbin showing my new design; FIG. 2 is a rear view thereof; FIG. 3 is a left-side view thereof; FIG. 4 is a right-side view thereof; FIG. 5 is a top view thereof; FIG. 6 is a bottom view thereof; FIG. 7 is a front perspective view thereof; and, FIG. 8 is a front perspective view of the dustbin in an open configuration. The broken lines shown in the drawings are for the purpose of illustrating portions of the dustbin that form no part of the claimed design.

**1 Claim, 8 Drawing Sheets**

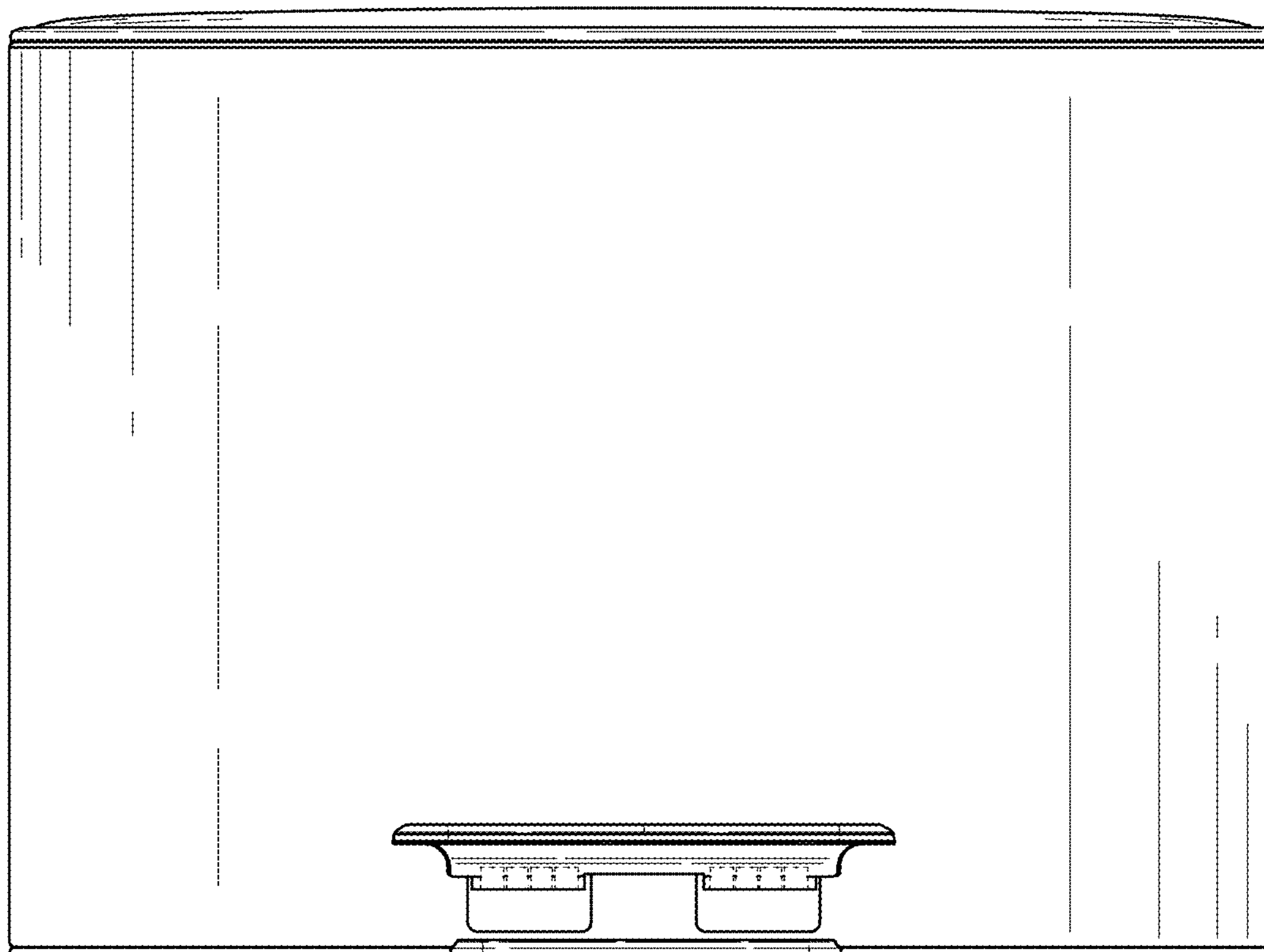

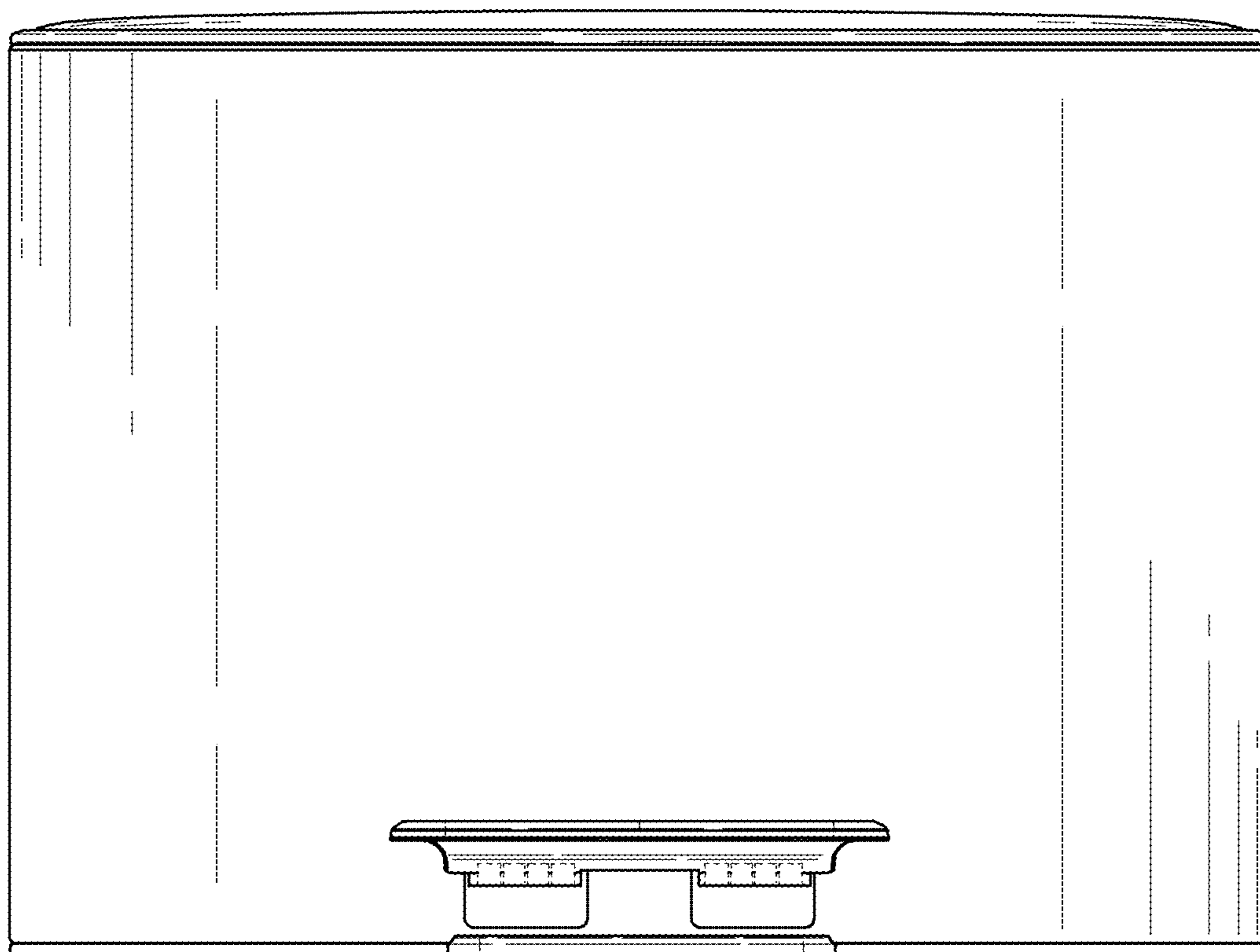

FIG. 1

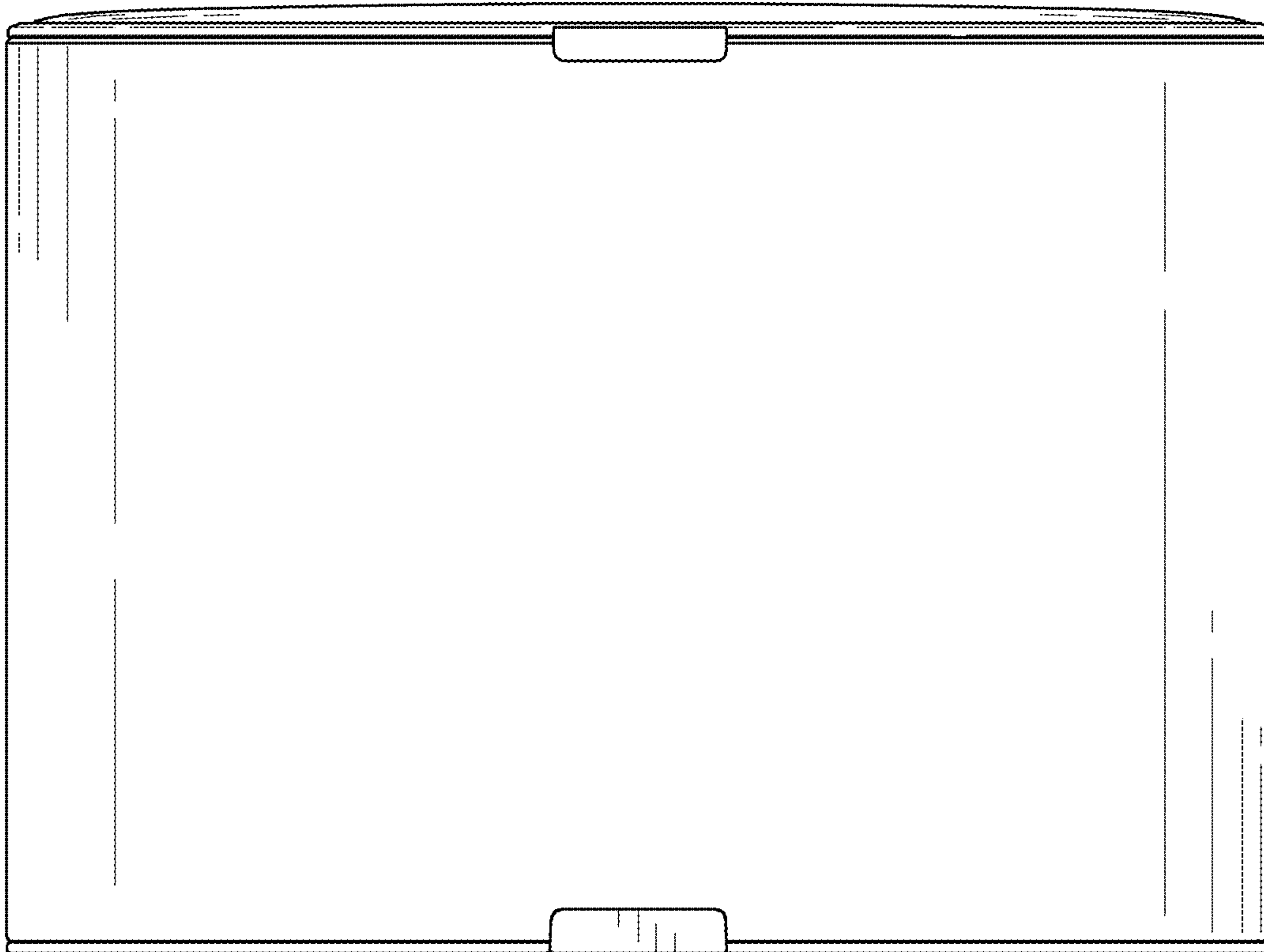

FIG. 2

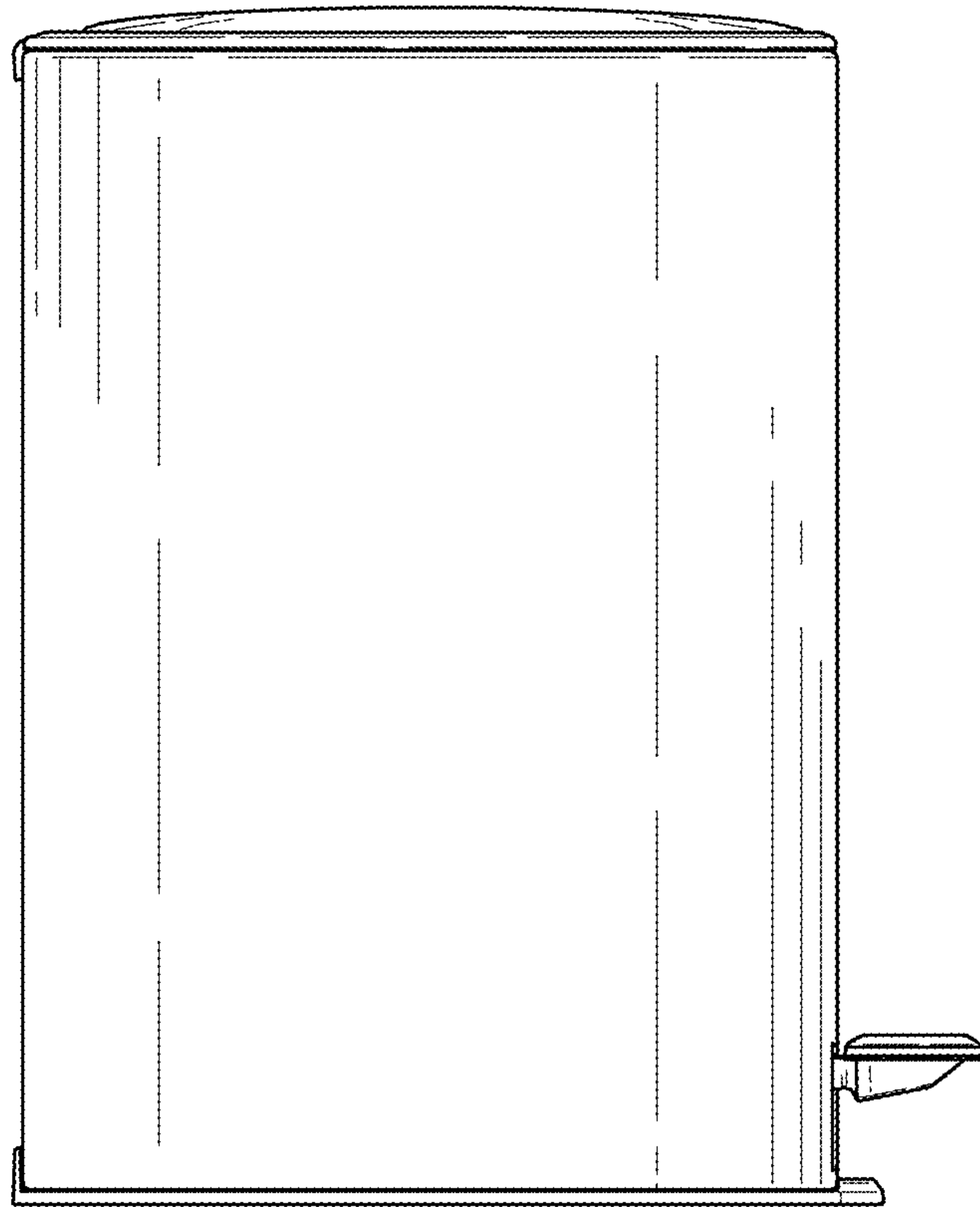

FIG. 3

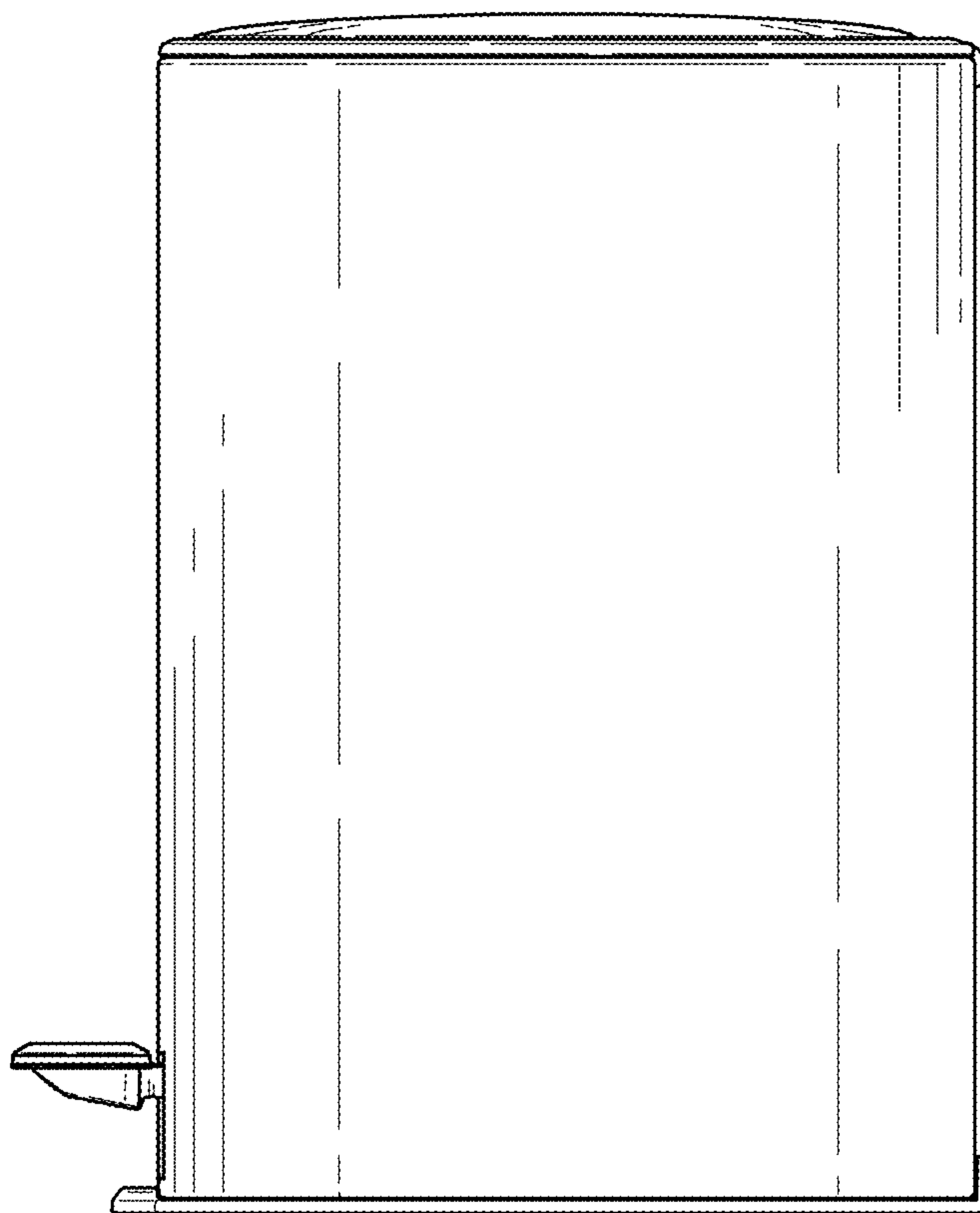

FIG. 4

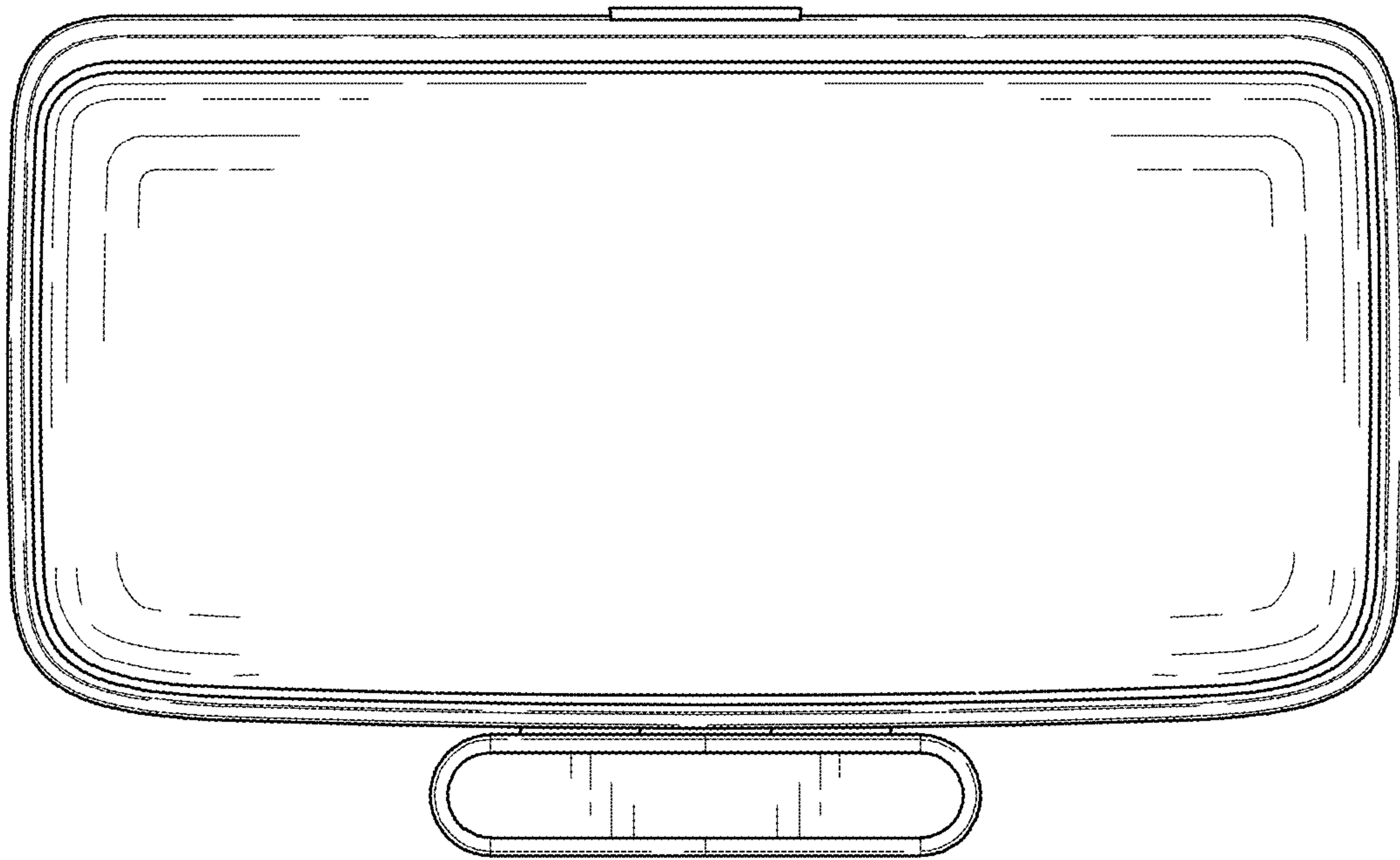

FIG. 5

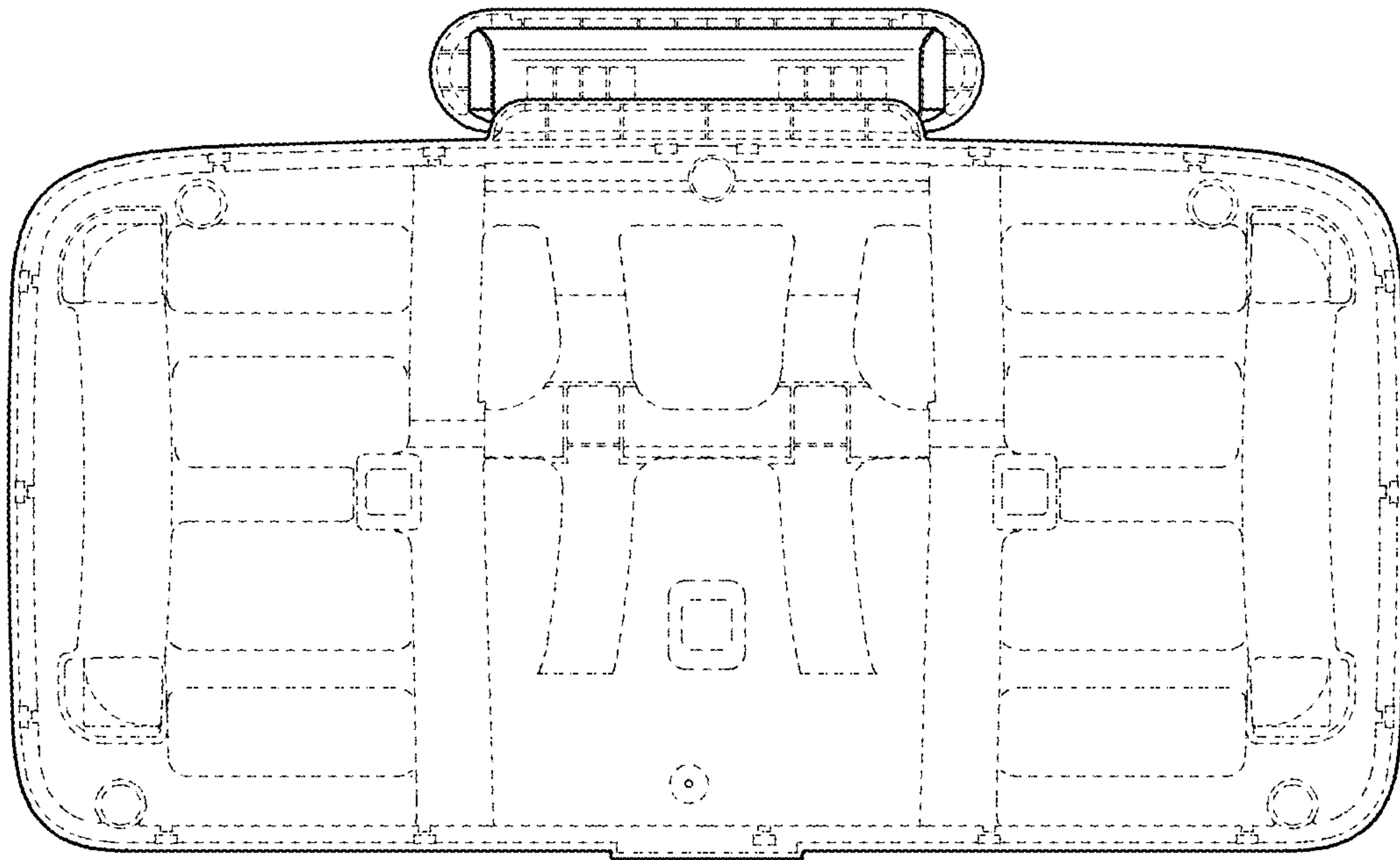

FIG. 6



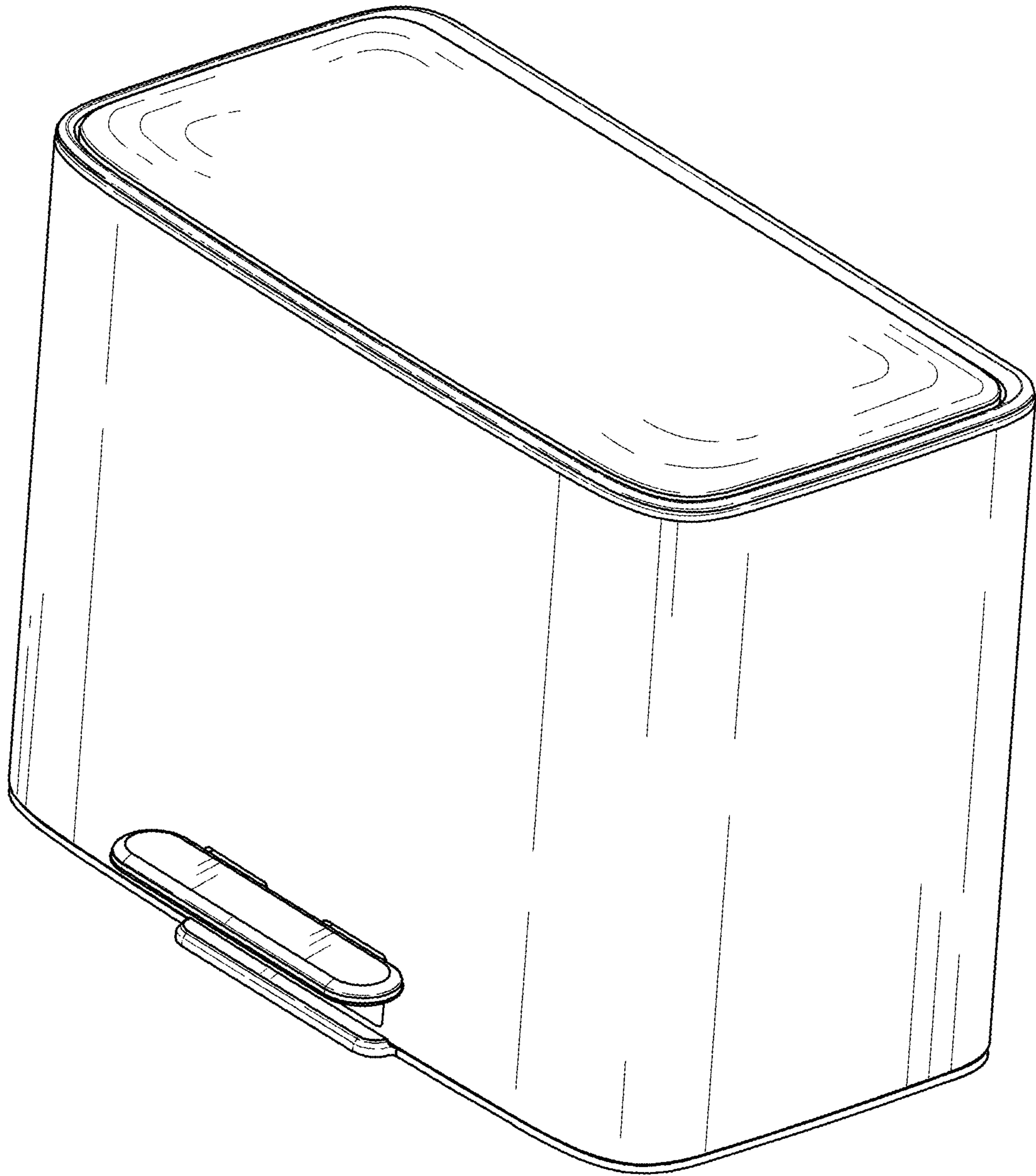

FIG. 7



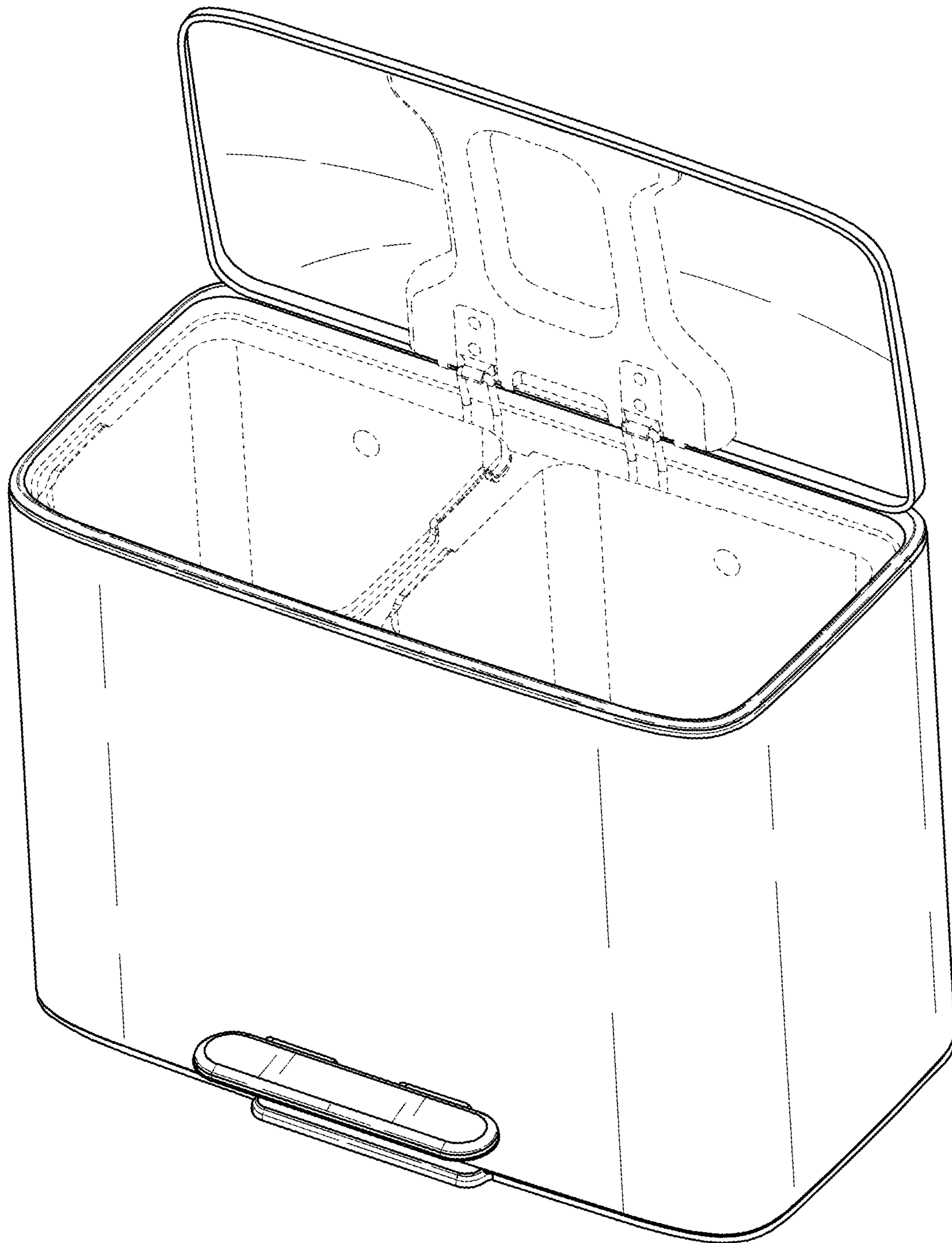

FIG. 8