



US00D915615S

(12) **United States Design Patent** (10) **Patent No.:** **US D915,615 S**  
**Chen** (45) **Date of Patent:** **\*\* Apr. 6, 2021**

(54) **MESSAGE ROLLER**  
(71) Applicant: **Guijun Chen**, Guangdong (CN)  
(72) Inventor: **Guijun Chen**, Guangdong (CN)  
(\*\*) Term: **15 Years**  
(21) Appl. No.: **29/755,386**  
(22) Filed: **Oct. 20, 2020**  
(51) **LOC (13) Cl.** ..... **28-03**  
(52) **U.S. Cl.**  
USPC ..... **D24/211**  
(58) **Field of Classification Search**  
USPC ..... D24/200, 211, 213, 214, 215; D8/14.1  
CPC ..... A61H 2015/0014; A61H 15/00; A61H  
2015/0042  
See application file for complete search history.

(56) **References Cited**

U.S. PATENT DOCUMENTS

D228,967 S *	10/1973	Holladay	.....	D24/212
D243,557 S *	3/1977	Kientz	.....	D24/212
D287,405 S *	12/1986	Nakao	.....	D24/211
D308,098 S *	5/1990	Lievonen	.....	D24/211
D346,450 S *	4/1994	Bruno	.....	D24/211
D452,572 S *	12/2001	Nakamura	.....	D24/200
D491,271 S *	6/2004	Siegfried	.....	D24/211
D491,671 S *	6/2004	Kim	.....	D24/211
D527,830 S *	9/2006	Chien	.....	D24/211
D545,975 S *	7/2007	Bell	.....	D24/211
D688,380 S *	8/2013	Nelson	.....	D24/211
D763,459 S *	8/2016	Vitko	.....	D24/211
D802,155 S *	11/2017	Cross	.....	D24/211
D855,820 S *	8/2019	Harashima	.....	D24/215
D870,907 S *	12/2019	Cheng	.....	D24/211
D891,631 S *	7/2020	Liu	.....	D24/211
D899,617 S *	10/2020	Soutelo Gomes	.....	D24/215
D902,422 S *	11/2020	Schaefer	.....	D24/211
2004/0254508 A1 *	12/2004	Lee	.....	A61H 7/003 601/119
2011/0257569 A1 *	10/2011	Robins	.....	A61H 15/00 601/137
2019/0099323 A1 *	4/2019	Nelson	.....	A61H 15/0092

2019/0216680 A1 *	7/2019	Lee	.....	A61F 7/007
2019/0274915 A1 *	9/2019	Cross	.....	A61H 15/0092
2020/0246214 A1 *	8/2020	Nelson	.....	A61H 1/00
2020/0390642 A1 *	12/2020	Kim	.....	A61H 15/0092

OTHER PUBLICATIONS

Amazon, "Odoland\_Trigger Point Muscle Roller", Oct. 23, 2020. [https://www.amazon.com/Odoland-Trigger-Fasciitis-Handheld-Myofascial/dp/B087BGDWT4/ref=cm\\_cr\\_arp\\_d\\_product\\_top?ie=UTF8](https://www.amazon.com/Odoland-Trigger-Fasciitis-Handheld-Myofascial/dp/B087BGDWT4/ref=cm_cr_arp_d_product_top?ie=UTF8). Shown on p. 1. (Year: 2020).\*  
Yogiloka, "Massage Roller", May 3, 2020. [https://yogiloka.com/products/trigger-point-massage-roller-quality-build?variant=36959349670053&currency=USD&utm\\_medium=product\\_sync&utm\\_source=google&utm\\_content=sag\\_organic&utm\\_campaign=sag\\_organic&gclid=CjwKCAiA8ov\\_BRAoEiwAOZogwaYs8gQDFEY\\_VawJg](https://yogiloka.com/products/trigger-point-massage-roller-quality-build?variant=36959349670053&currency=USD&utm_medium=product_sync&utm_source=google&utm_content=sag_organic&utm_campaign=sag_organic&gclid=CjwKCAiA8ov_BRAoEiwAOZogwaYs8gQDFEY_VawJg). (Year: 2020).\*  
Amazon, "JUNLIS\_Foam Roller Massage Stick", Dec. 23, 2020. [https://www.amazon.com/JUNLIS-Massage-Relieve-Exercise-Massager/dp/B08GFJ1JQN/ref=sr\\_1\\_57?dchild=1&keywords=refa+trigger+massage+roller&qid=1608743585&sr=8-57](https://www.amazon.com/JUNLIS-Massage-Relieve-Exercise-Massager/dp/B08GFJ1JQN/ref=sr_1_57?dchild=1&keywords=refa+trigger+massage+roller&qid=1608743585&sr=8-57). Shown on p. 1. (Year: 2020).\*

\* cited by examiner

*Primary Examiner* — Cynthia Ramirez  
*Assistant Examiner* — Michael A Maharajh  
(74) *Attorney, Agent, or Firm* — ScienBiziP, P.C.

(57) **CLAIM**

The ornamental design for a massage roller, as shown and described.

**DESCRIPTION**

FIG. 1 is a perspective view of a massage roller, showing my design.  
FIG. 2 is a front elevation view thereof.  
FIG. 3 is a rear elevation view thereof.  
FIG. 4 is a left side elevation thereof.  
FIG. 5 is a right side elevation thereof.  
FIG. 6 is a top plan view thereof; and,  
FIG. 7 is a bottom plan view thereof.

**1 Claim, 7 Drawing Sheets**

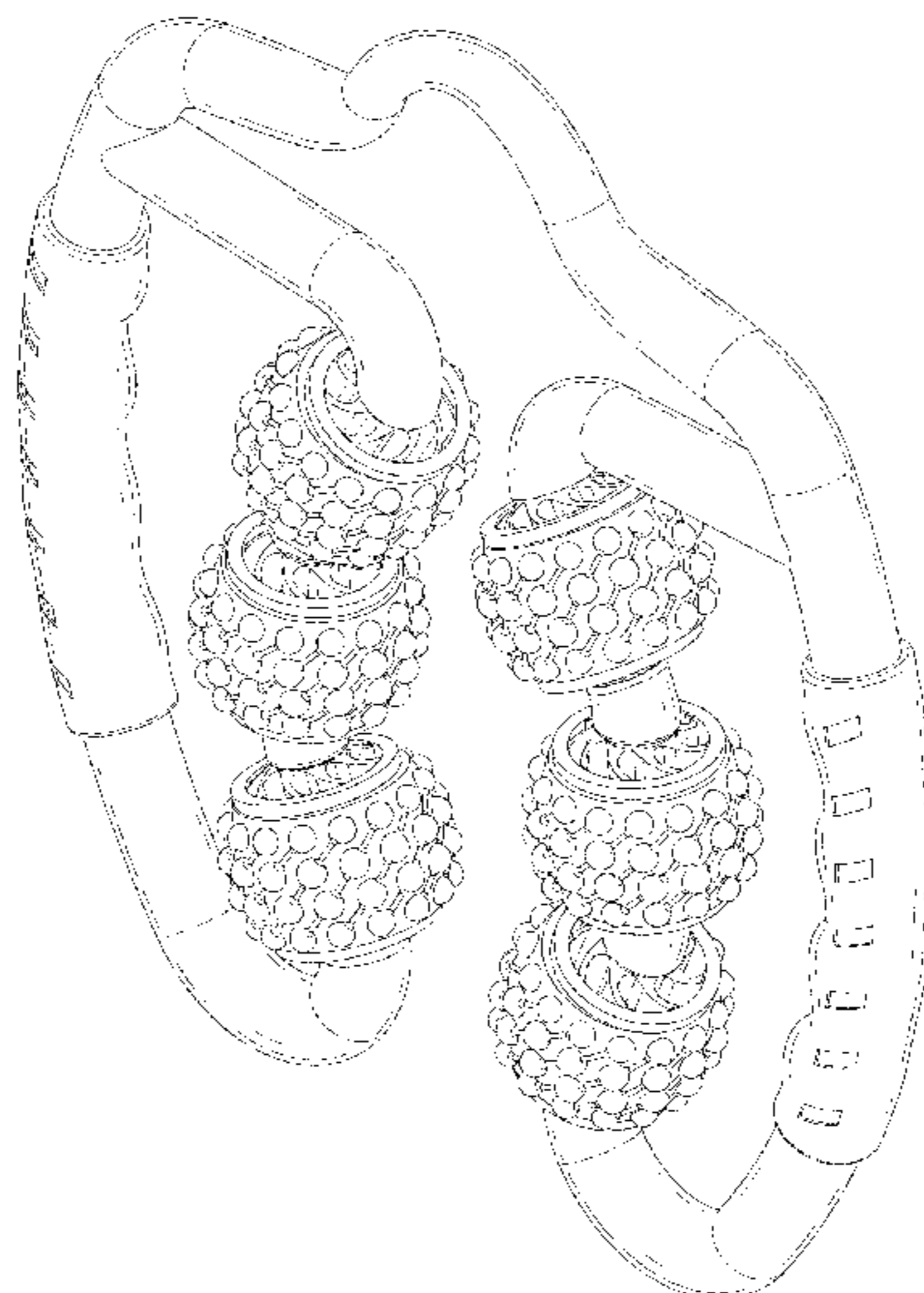

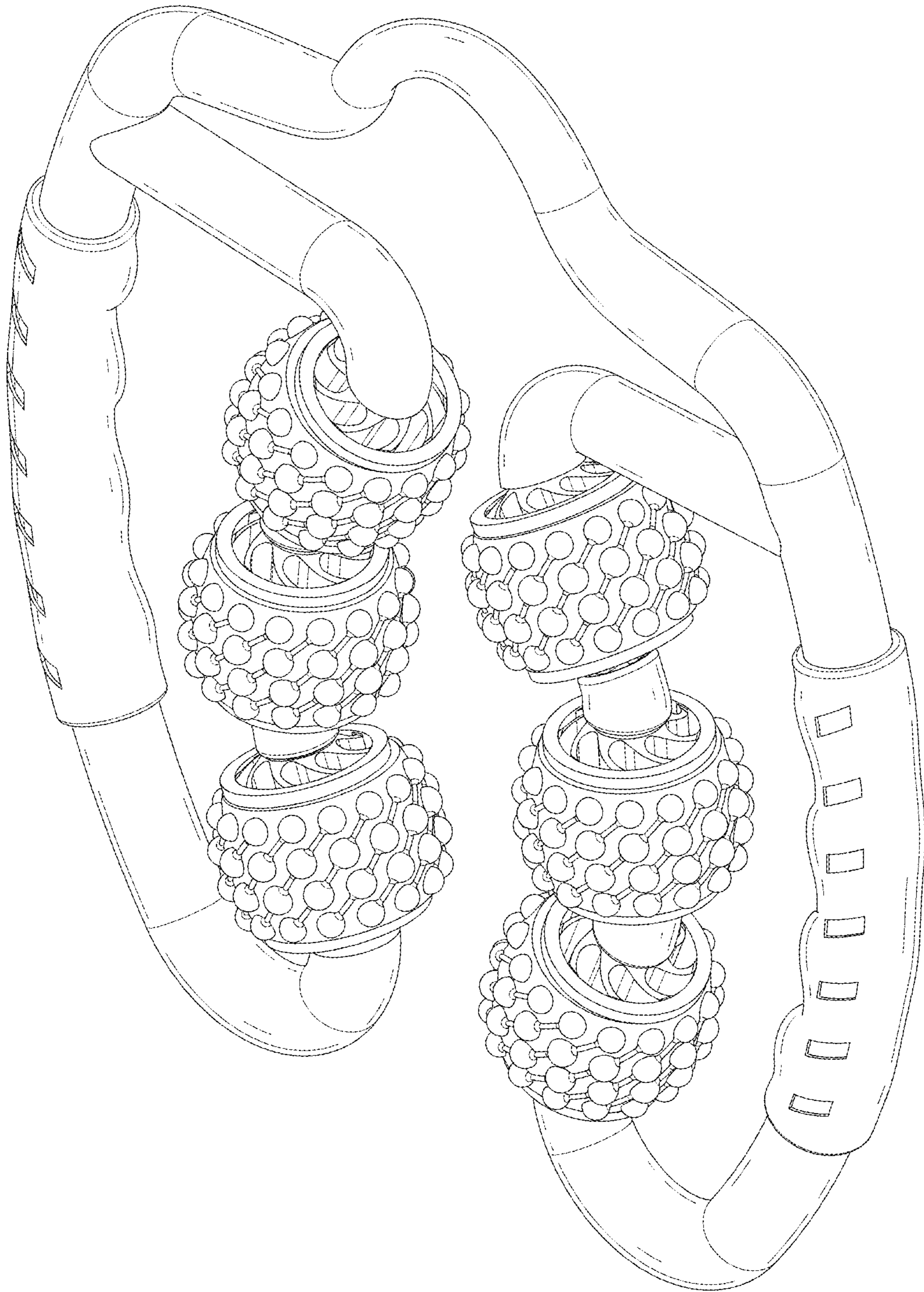

FIG.1

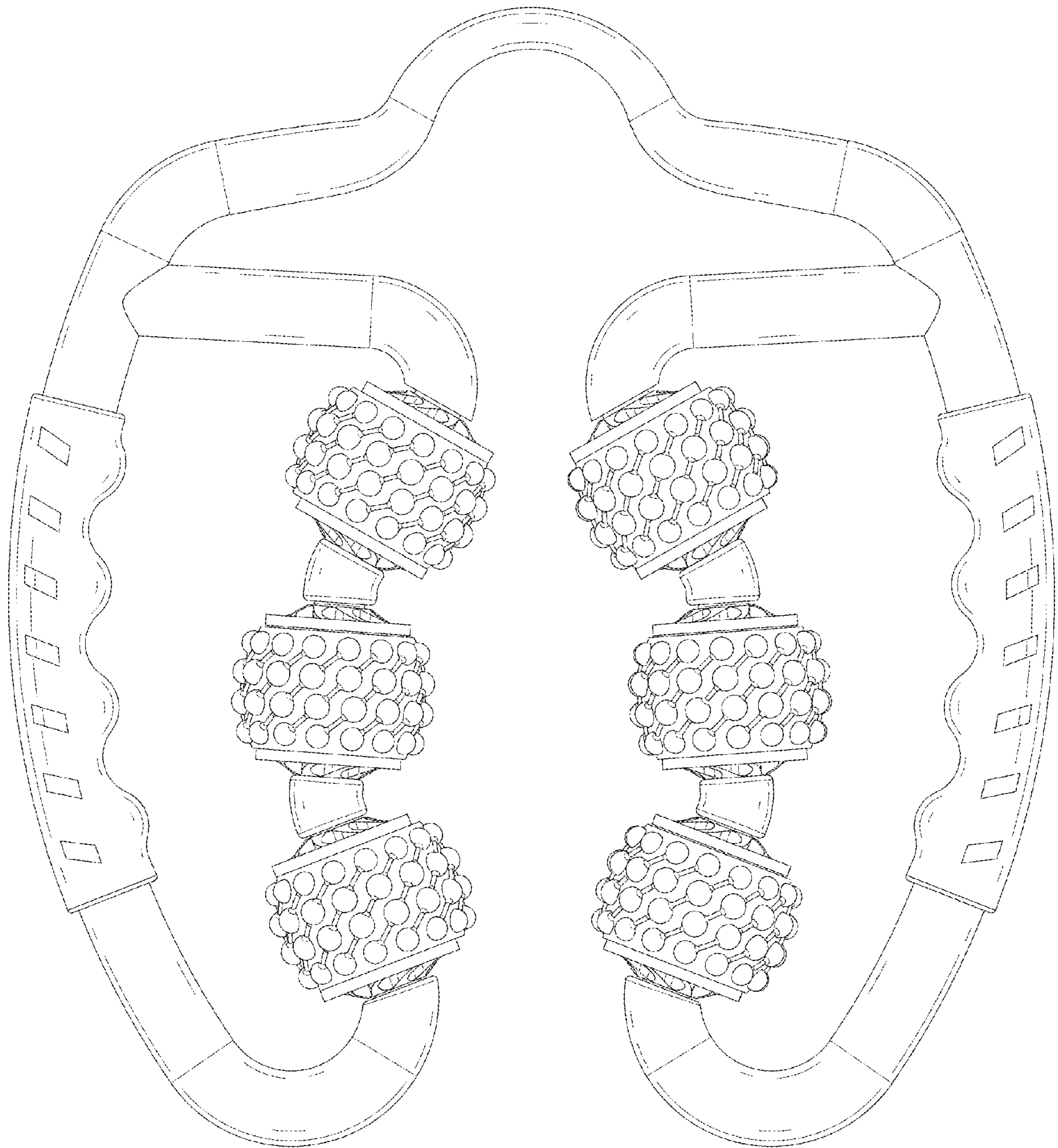

FIG.2

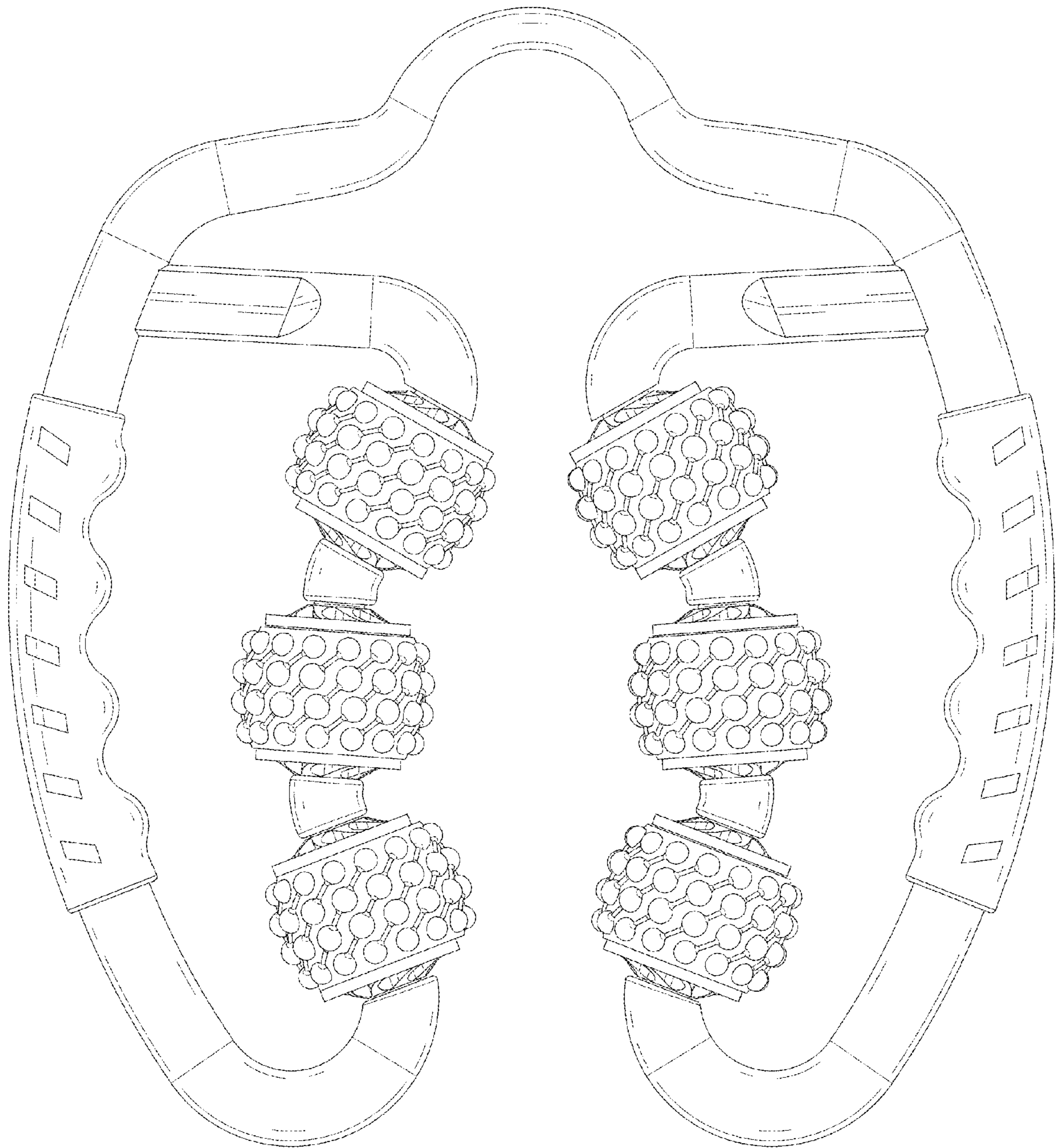

FIG.3

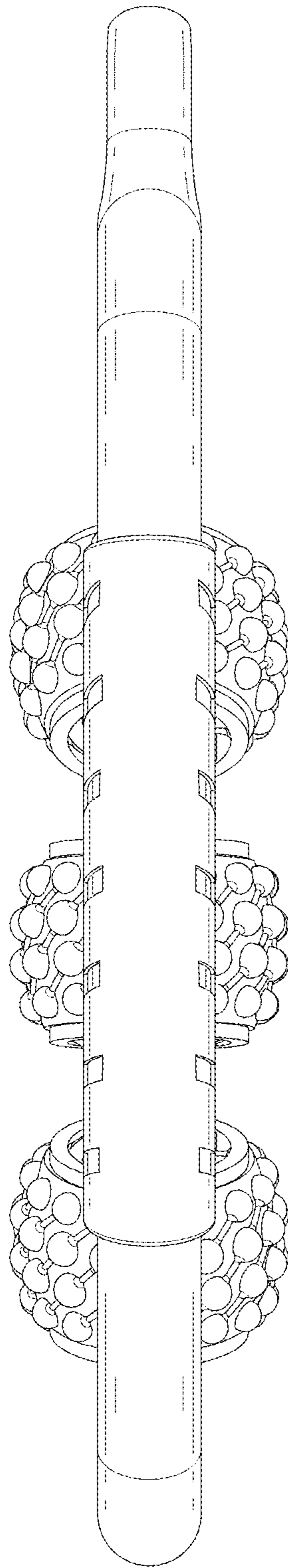

FIG. 4

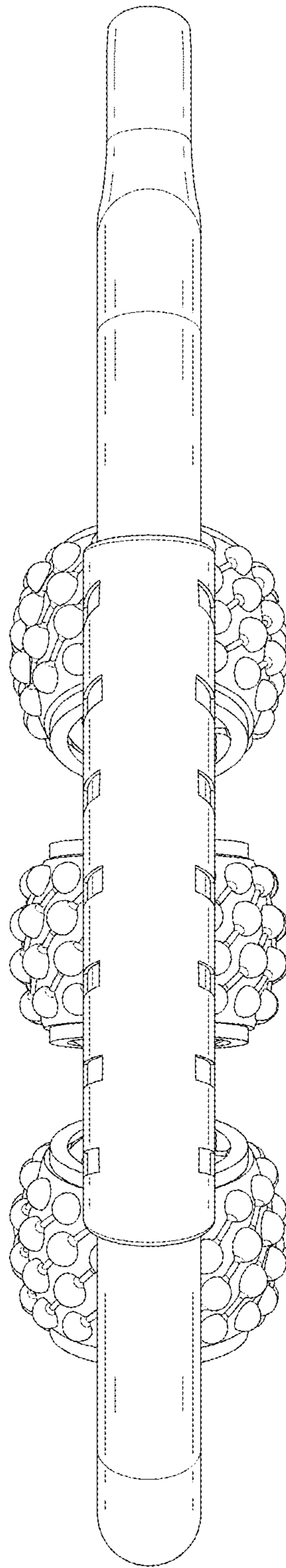

FIG. 5

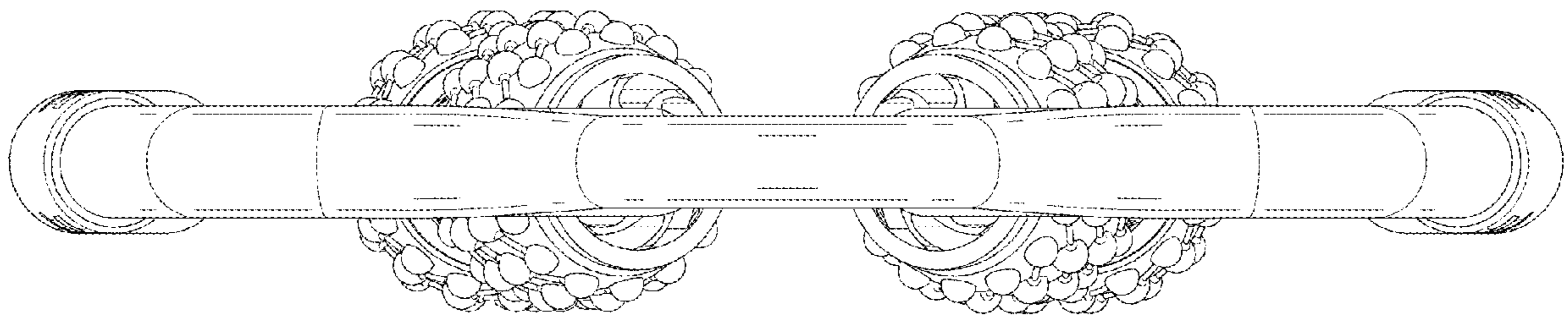

FIG. 6

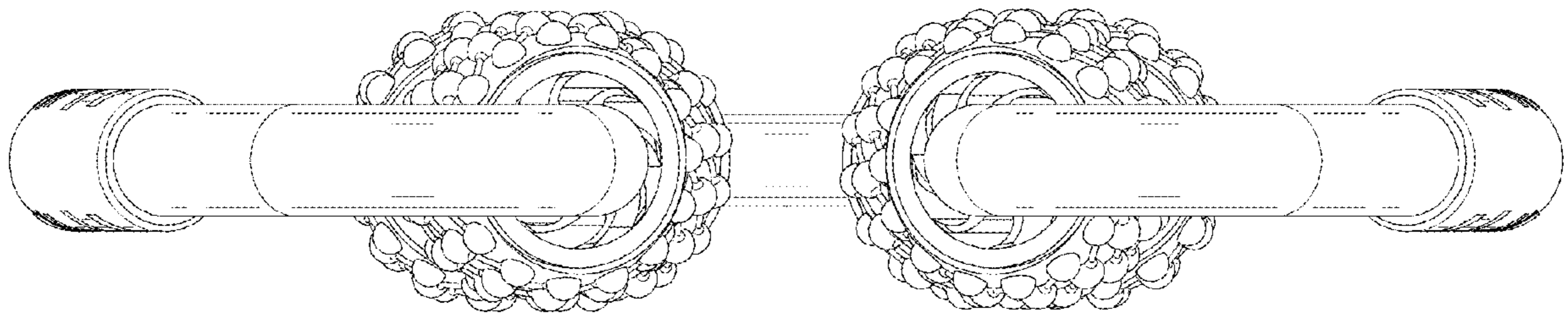

FIG.7