



US00D915572S

(12) **United States Design Patent**  
**Fujioka et al.**

(10) **Patent No.:** **US D915,572 S**

(45) **Date of Patent:** **\*\* Apr. 6, 2021**

(54) **AIR CONDITIONER**

(71) Applicant: **FUJITSU GENERAL LIMITED,**  
Kawasaki (JP)

(72) Inventors: **Mitsuo Fujioka,** Kawasaki (JP);  
**Takayuki Kudo,** Kawasaki (JP)

(73) Assignee: **FUJITSU GENERAL LIMITED,**  
Kawasaki (JP)

(\*\*) Term: **15 Years**

(21) Appl. No.: **29/707,199**

(22) Filed: **Sep. 26, 2019**

(30) **Foreign Application Priority Data**

Apr. 1, 2019 (JP) ..... 2019-007044

Apr. 1, 2019 (JP) ..... 2019-007045

Apr. 1, 2019 (JP) ..... 2019-007046

(51) **LOC (13) Cl.** ..... **23-04**

(52) **U.S. Cl.**  
USPC ..... **D23/351**

(58) **Field of Classification Search**  
USPC ..... D23/333, 351-354, 388  
CPC .... F24F 1/00; F24F 1/0007; F24F 1/02; F24F  
1/08; F24F 1/42; F24F 1/56; F24F 1/60;  
F24F 3/044; F24F 3/048; F24F 3/16;  
G05D 23/1905; G05D 23/1932; G05D  
23/1902; G05D 23/1931; G05B 19/0426;  
G05B 19/409; G05B 15/02  
See application file for complete search history.

(56) **References Cited**

**U.S. PATENT DOCUMENTS**

D426,626 S \* 6/2000 Nonaka ..... D23/351

D454,188 S \* 3/2002 Nonaka ..... D23/351

D553,726 S \* 10/2007 Niki ..... D23/351

D565,712 S \* 4/2008 Nagahori ..... D23/351

(Continued)

*Primary Examiner* — Natasha Vujcic

(74) *Attorney, Agent, or Firm* — Sughrue Mion, PLLC

(57) **CLAIM**

The ornamental design for an air conditioner, as shown and described.

**DESCRIPTION**

FIG. 1 is a perspective view of an air conditioner according to a first embodiment showing our new design;

FIG. 2 is a front view thereof;

FIG. 3 is a rear view thereof;

FIG. 4 is a left side view thereof;

FIG. 5 is a right side view thereof;

FIG. 6 is a top view thereof; and

FIG. 7 is a bottom view thereof;

FIG. 8 is a perspective view showing an operating state thereof;

FIG. 9 is a perspective view of an air conditioner according to a second embodiment showing our new design;

FIG. 10 is a front view thereof;

FIG. 11 is a rear view thereof;

FIG. 12 is a left side view thereof;

FIG. 13 is a right side view thereof;

FIG. 14 is a top view thereof;

FIG. 15 is a bottom view thereof;

FIG. 16 is a perspective view showing an operating state thereof;

FIG. 17 is a perspective view of an air conditioner according to a third embodiment showing our new design;

FIG. 18 is a front view thereof;

FIG. 19 is a rear view thereof;

FIG. 20 is a left side view thereof;

FIG. 21 is a right side view thereof;

FIG. 22 is a top view thereof;

FIG. 23 is a bottom view thereof; and,

FIG. 24 is a perspective view showing an operating state thereof.

**1 Claim, 18 Drawing Sheets**

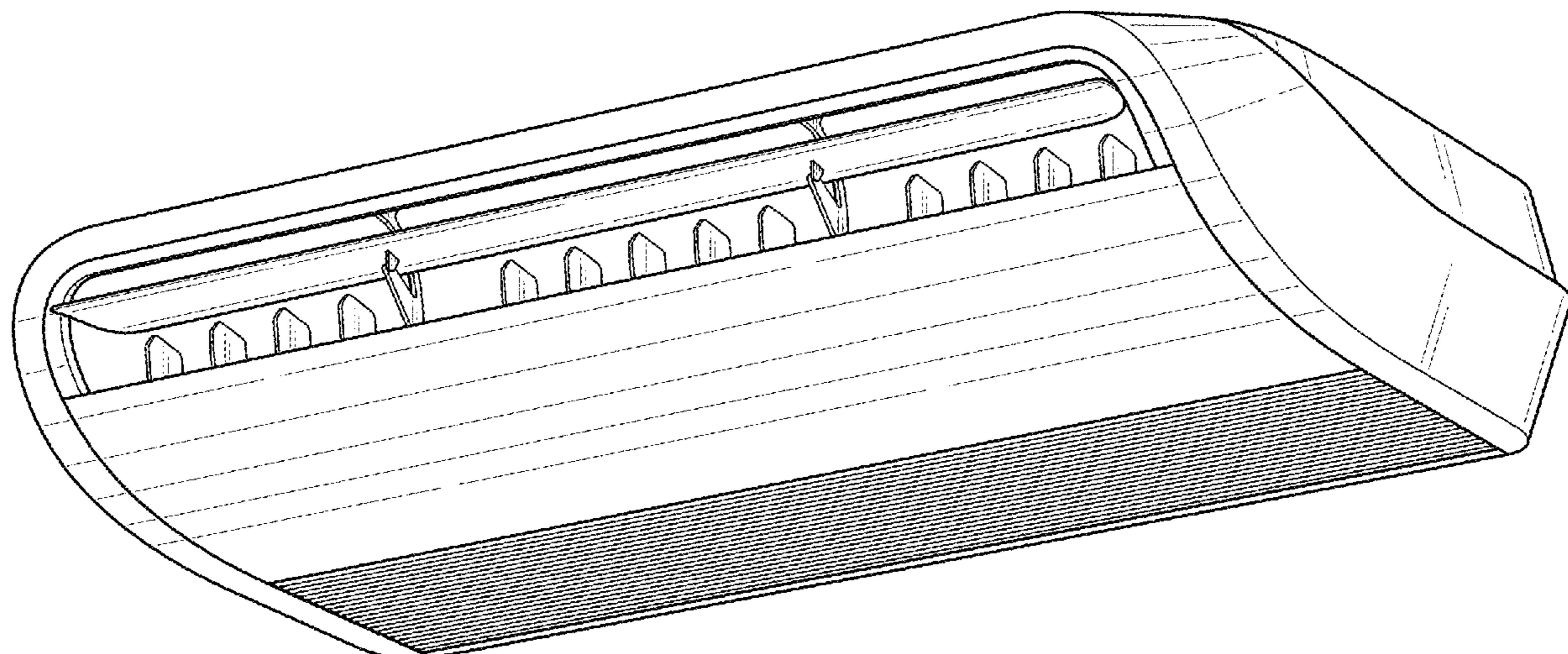

(56)

**References Cited**

U.S. PATENT DOCUMENTS

D580,036 S	*	11/2008	Nakamura .....	D23/351
D580,037 S	*	11/2008	Seki .....	D23/351
D580,038 S	*	11/2008	Seki .....	D23/351
D581,504 S	*	11/2008	Nakamura .....	D23/351
D593,664 S	*	6/2009	Chouji .....	D23/351
D593,665 S	*	6/2009	Chouji .....	D23/351
D678,995 S	*	3/2013	Hoshino .....	D23/388
D685,072 S	*	6/2013	Li .....	D23/351
D700,305 S	*	2/2014	Seki .....	D23/351
D772,386 S	*	11/2016	Kim .....	D23/351
D858,734 S	*	9/2019	Puffer .....	D23/372

\* cited by examiner

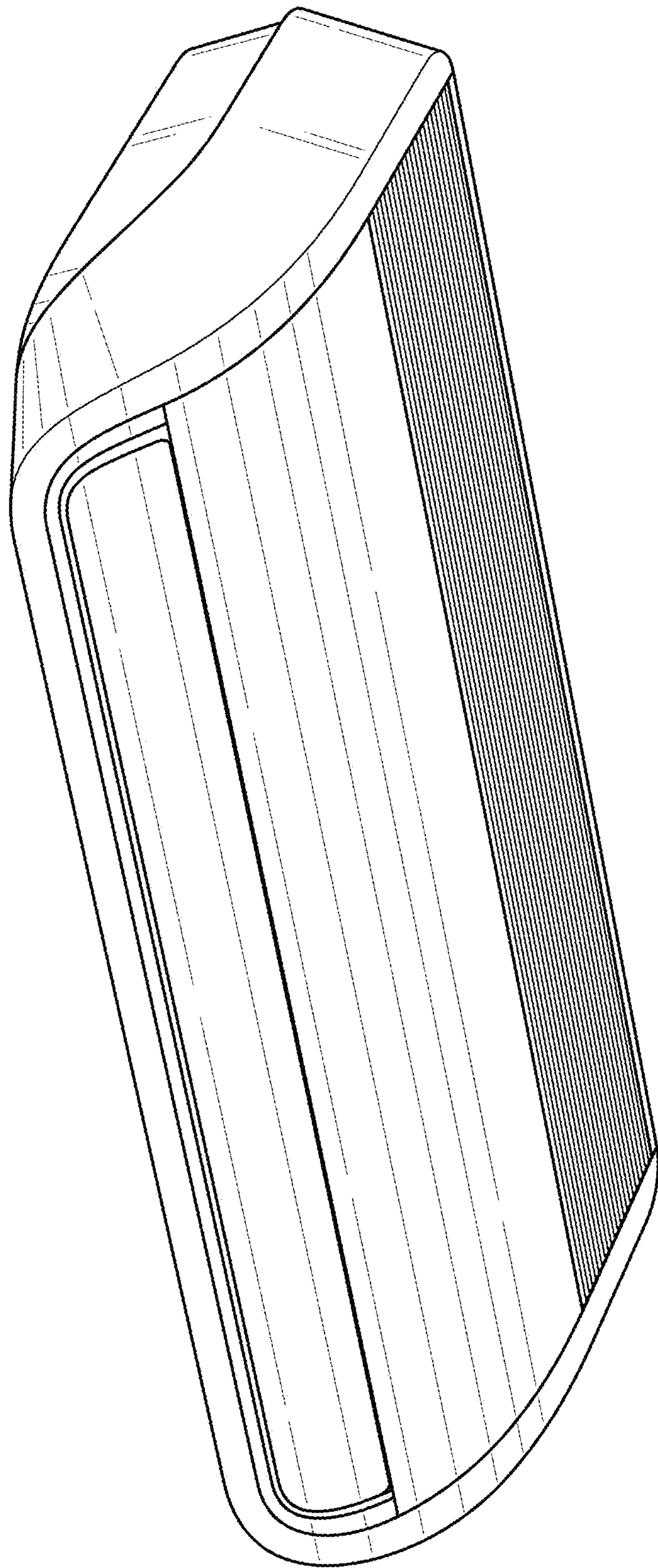

FIG. 1

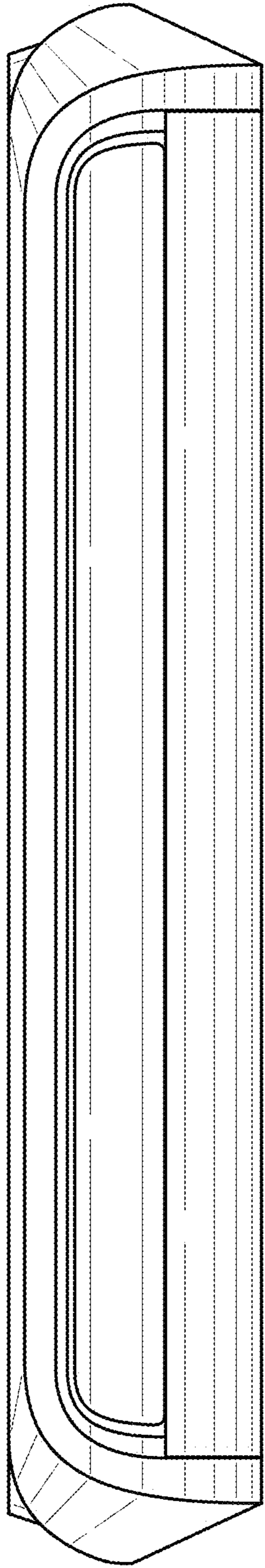

FIG. 2

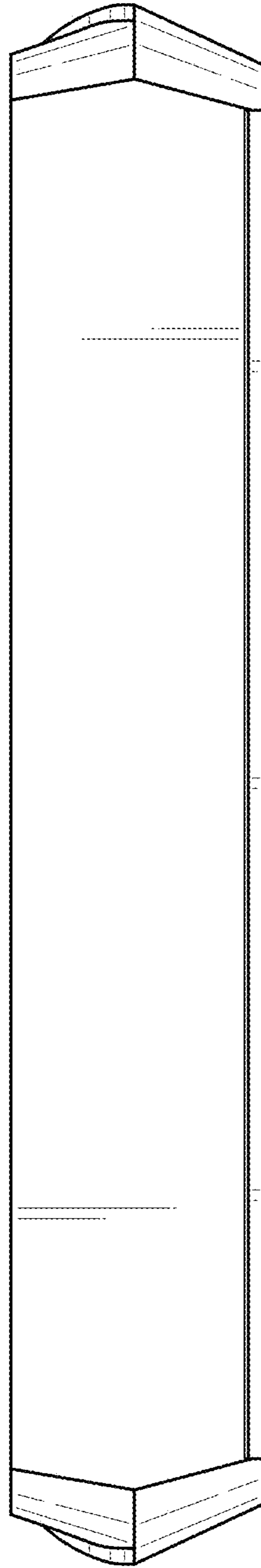

FIG. 3

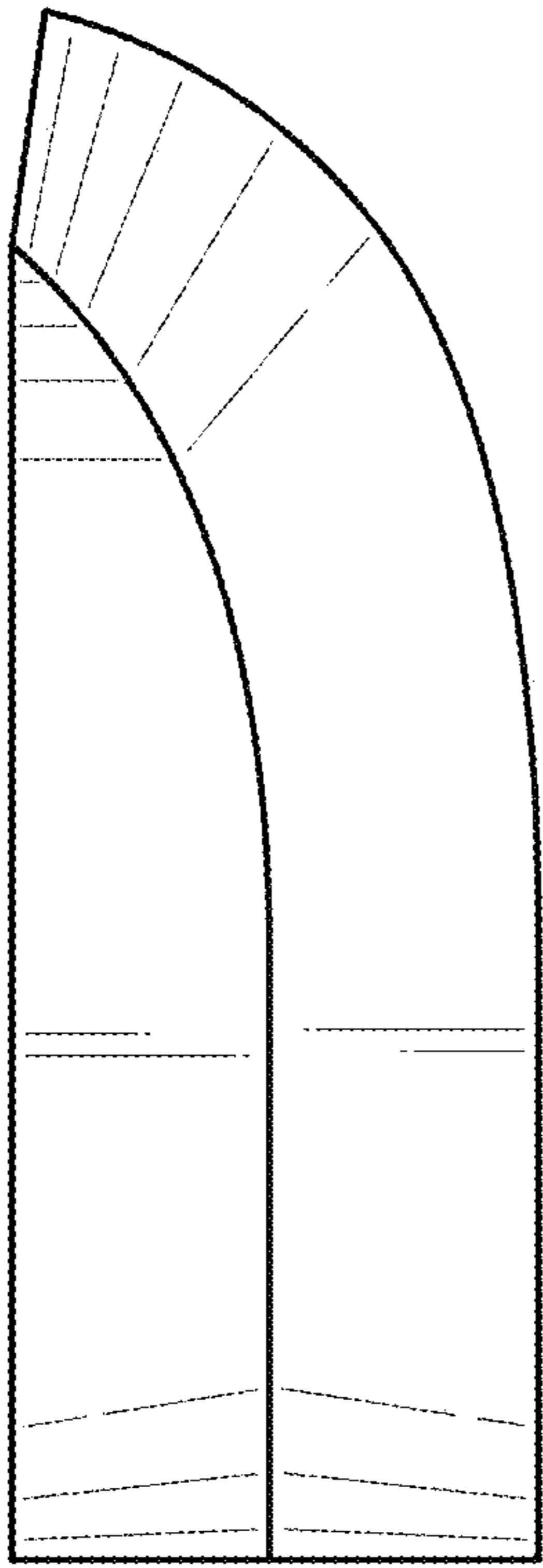

FIG. 4

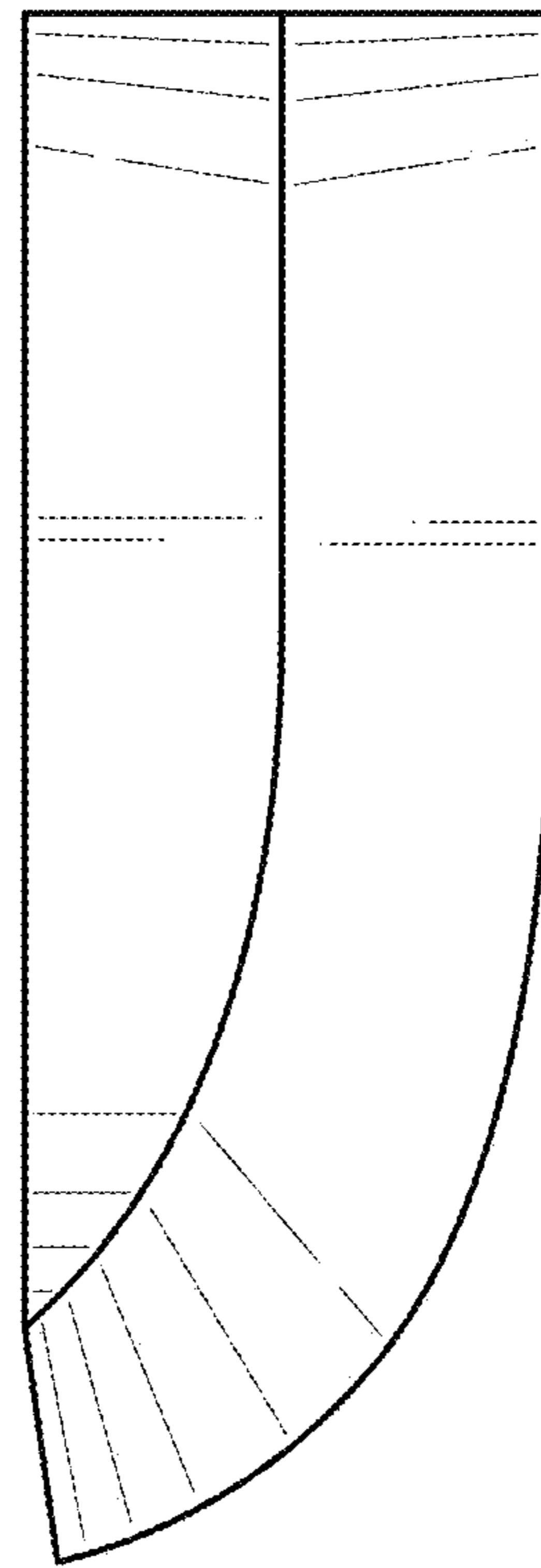

FIG. 5

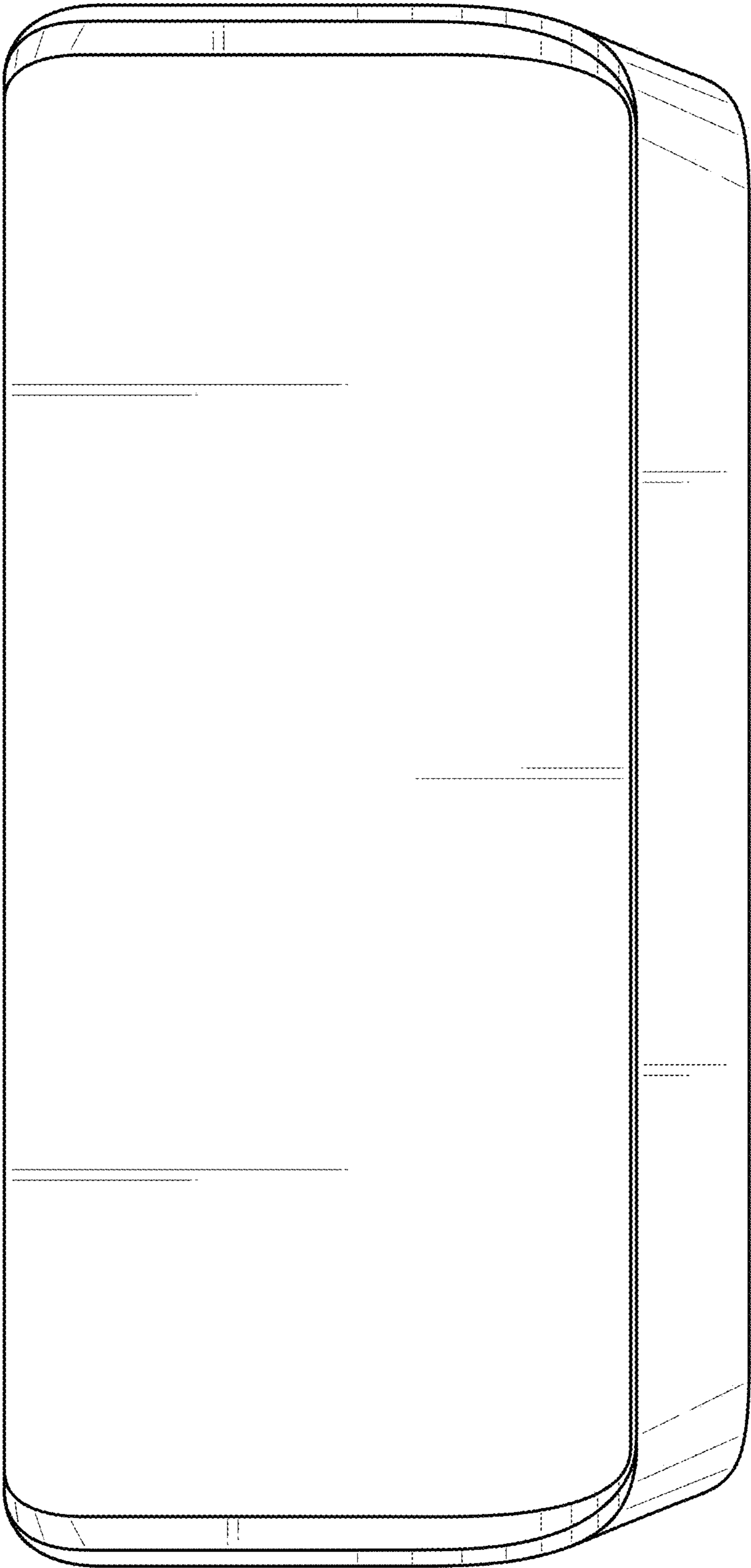

FIG. 6

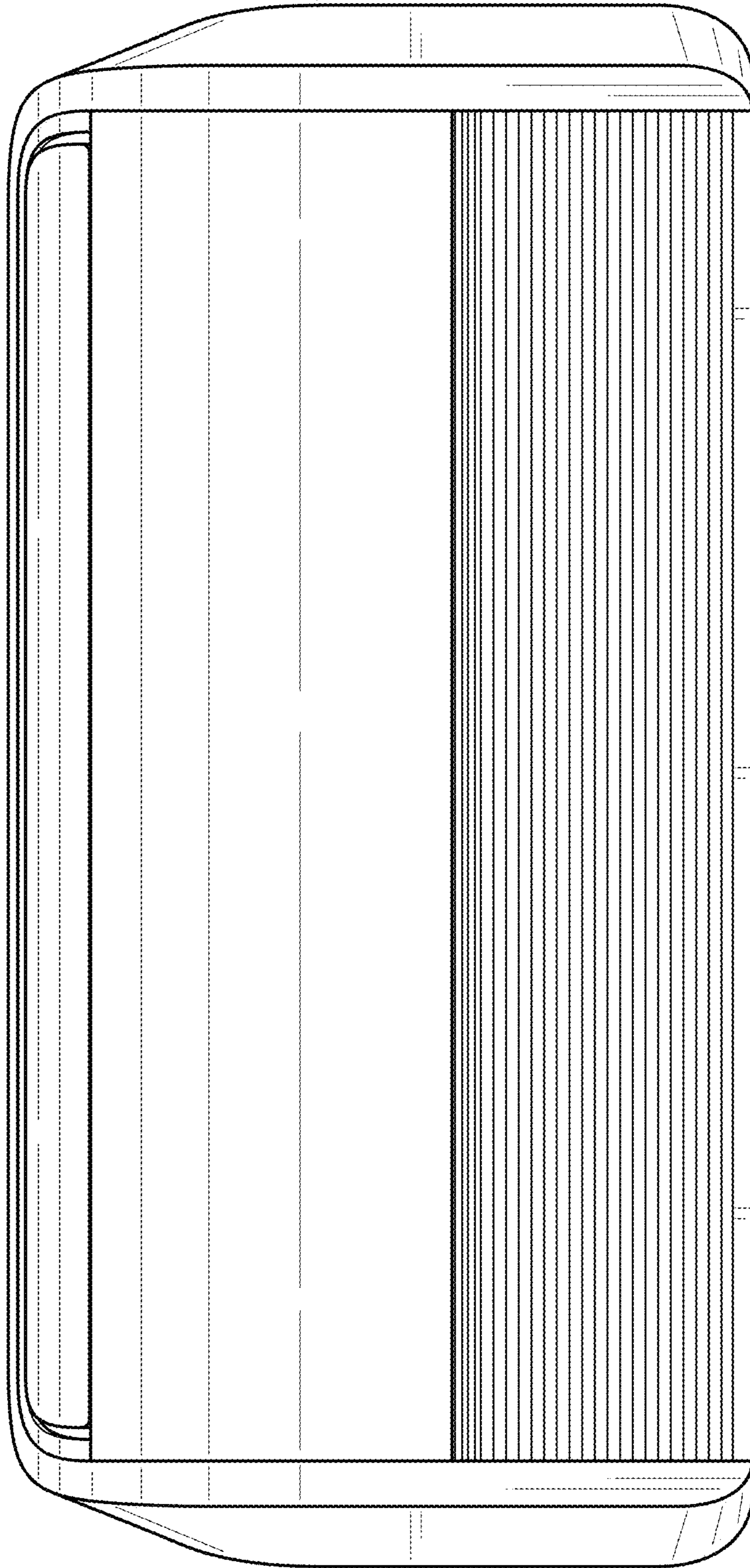

FIG. 7

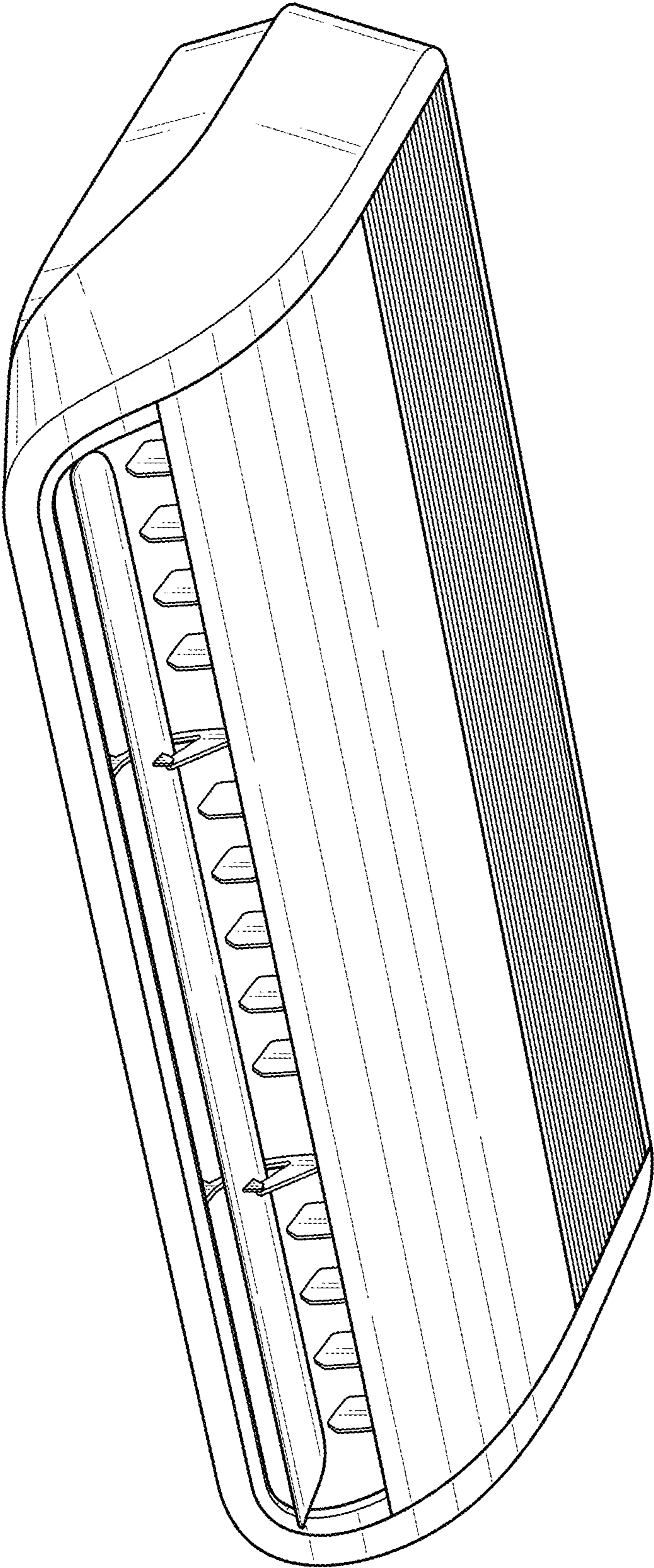

FIG. 8



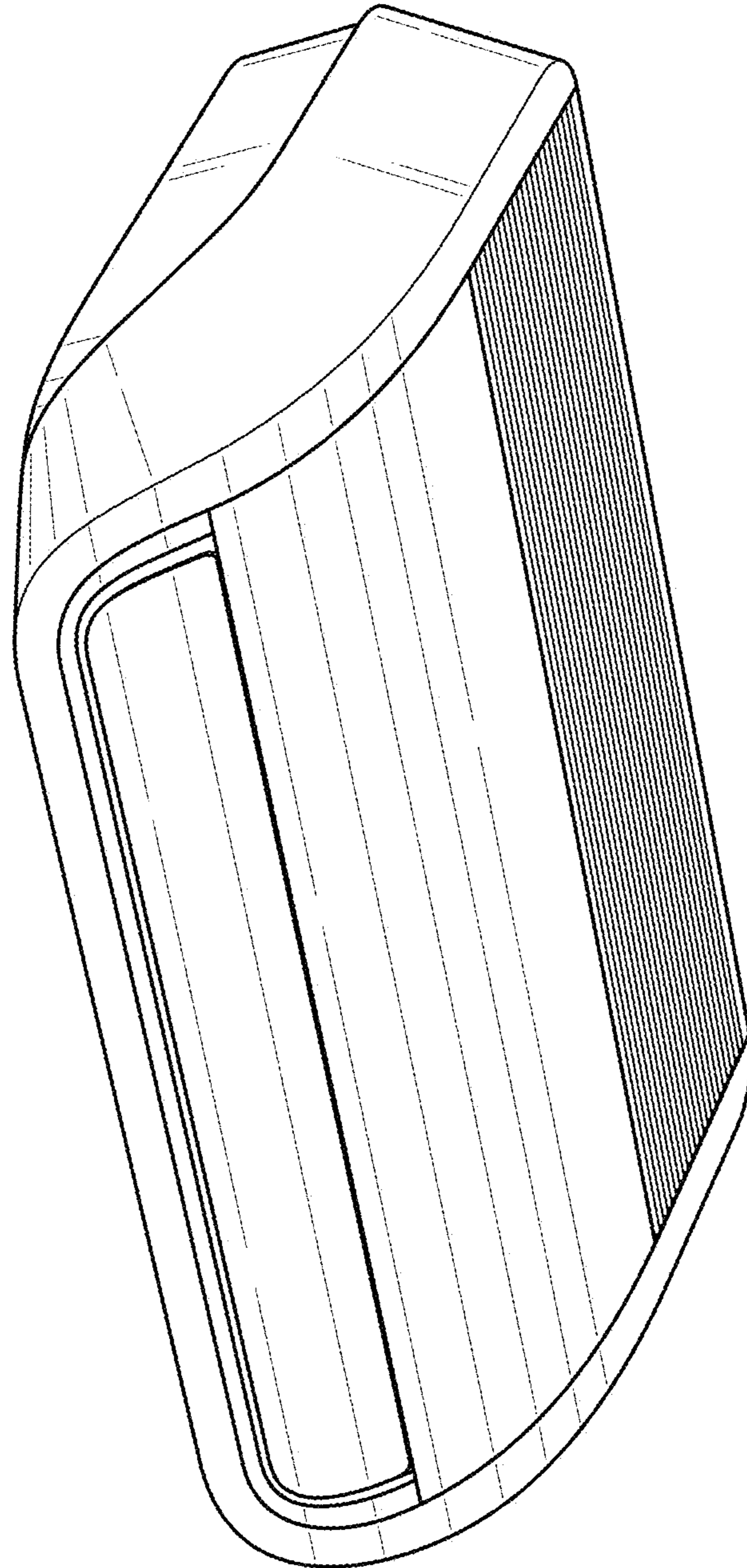

FIG. 9

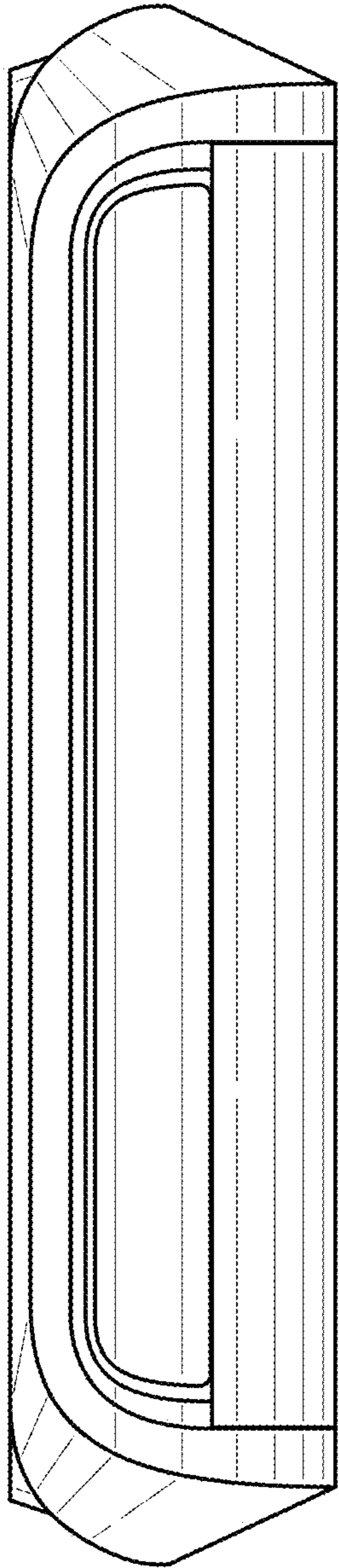

FIG. 10

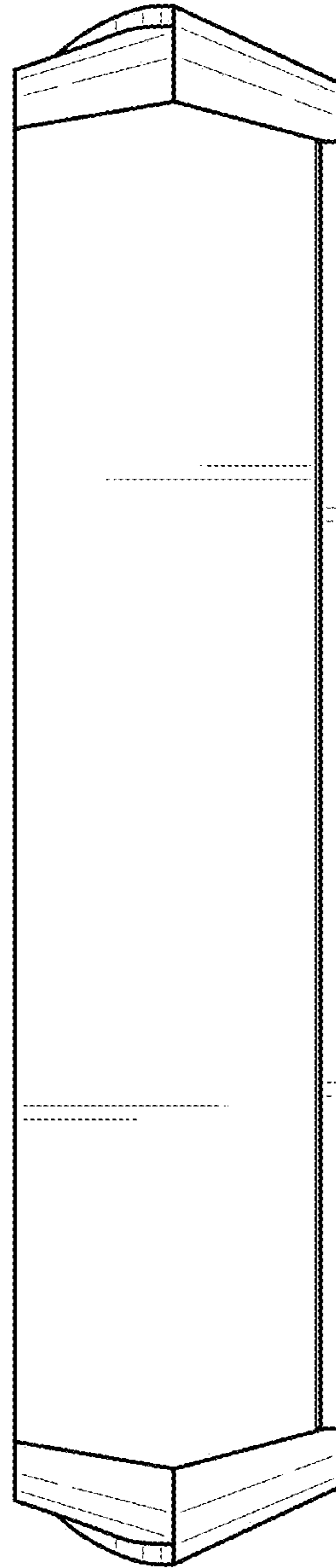

FIG. 11

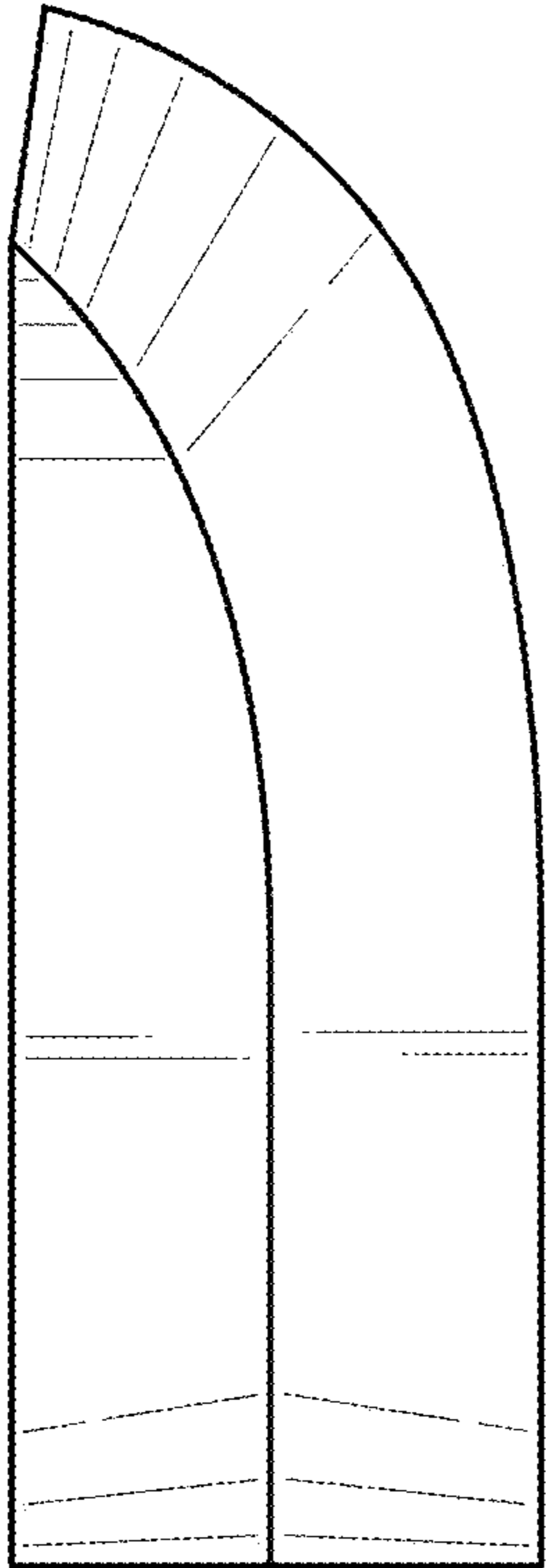

FIG. 12

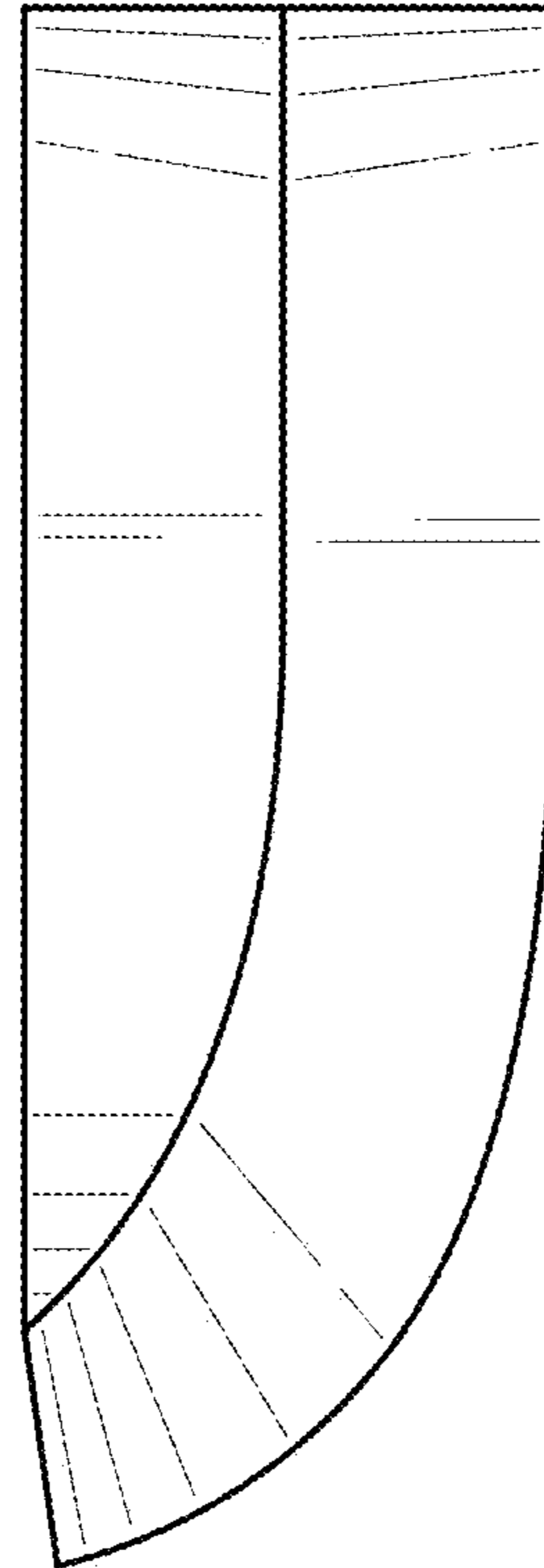

FIG. 13

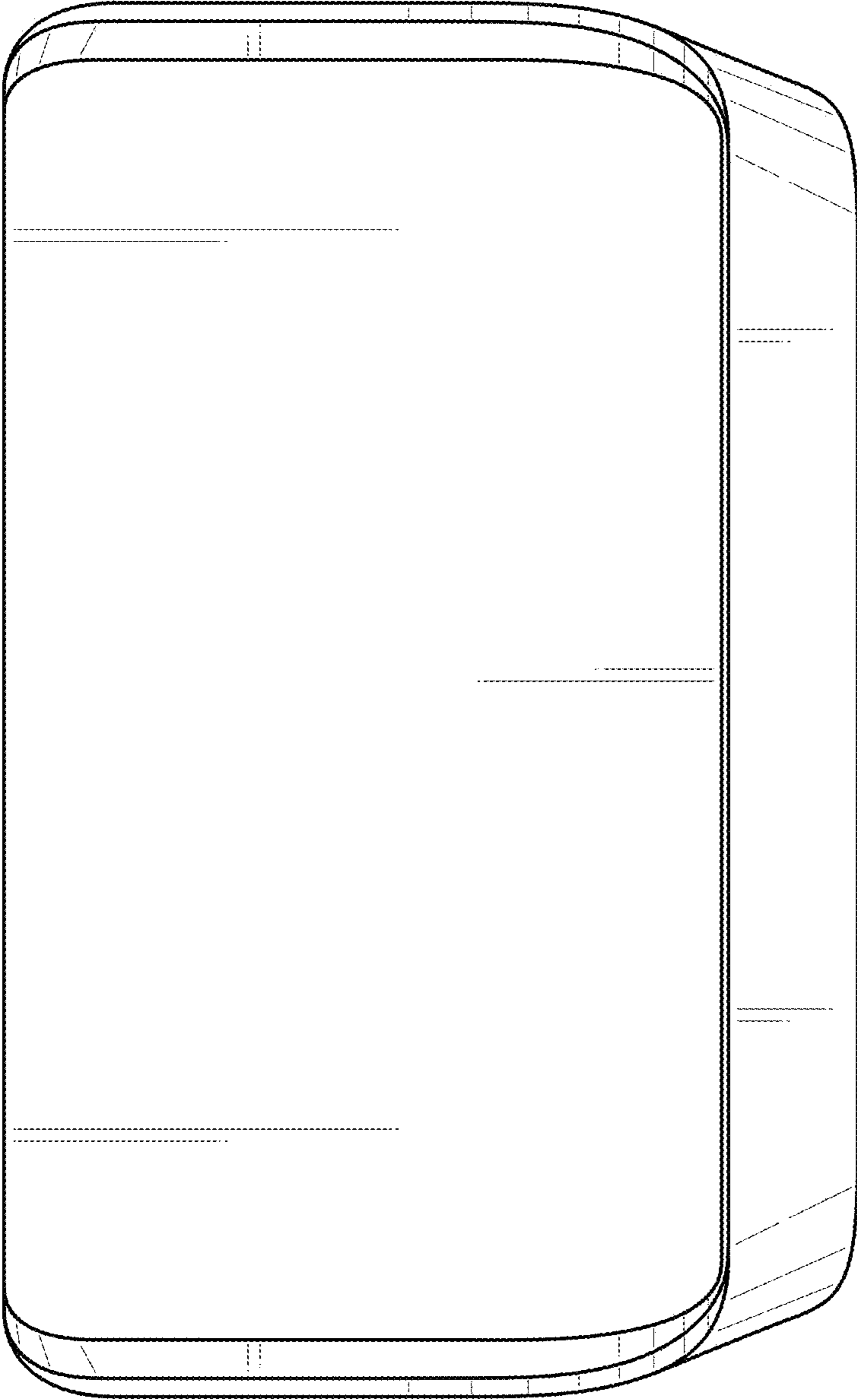

FIG. 14

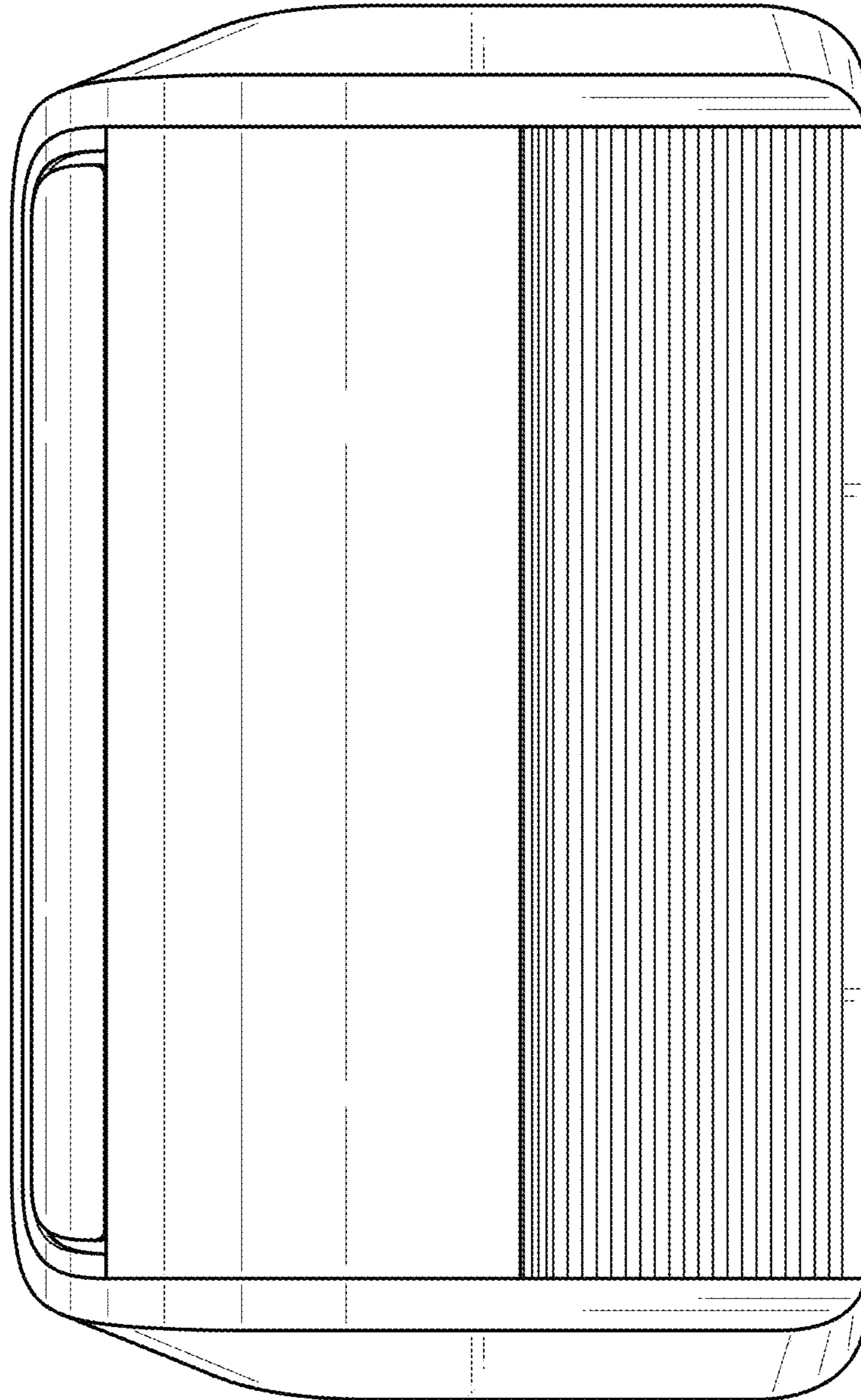

FIG. 15

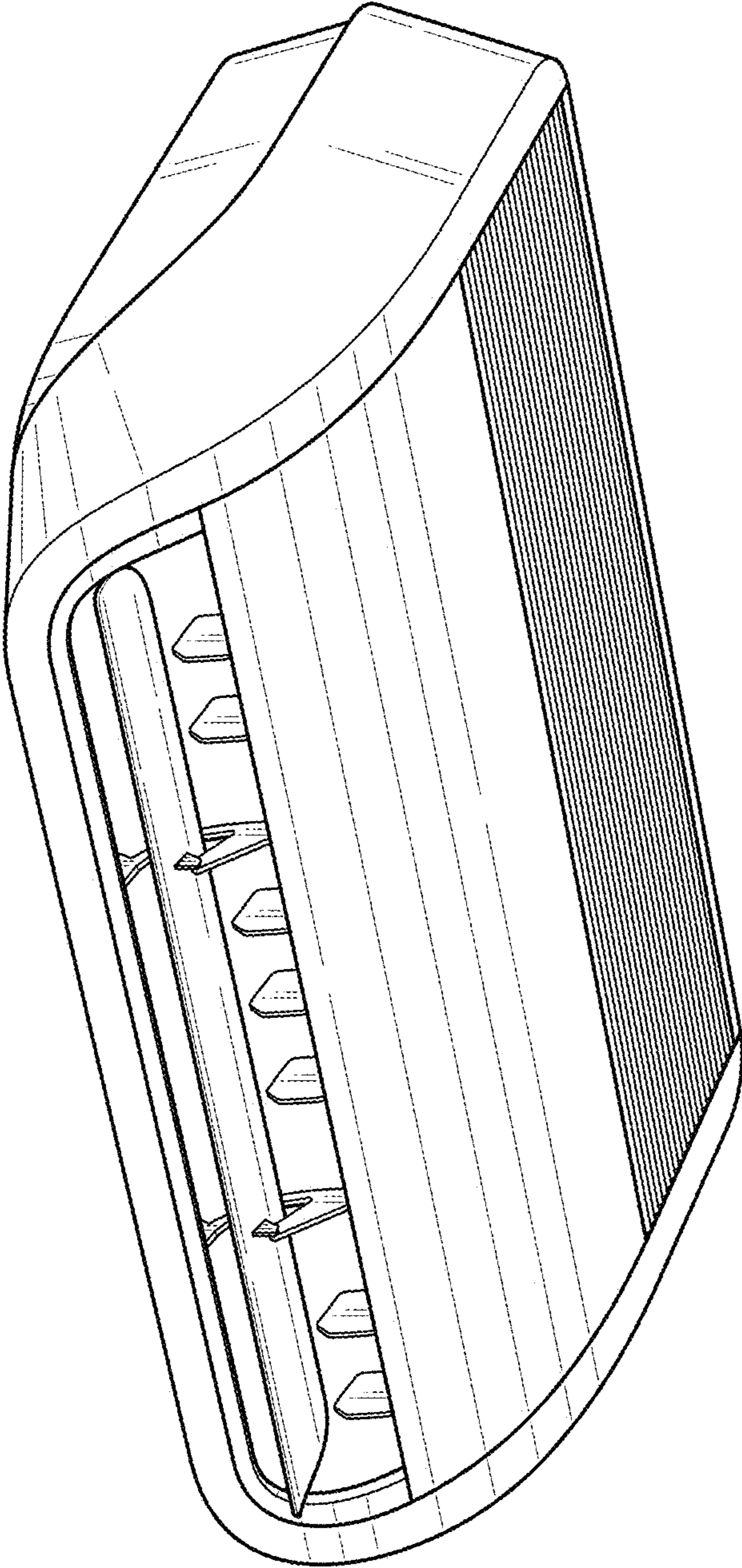

FIG. 16

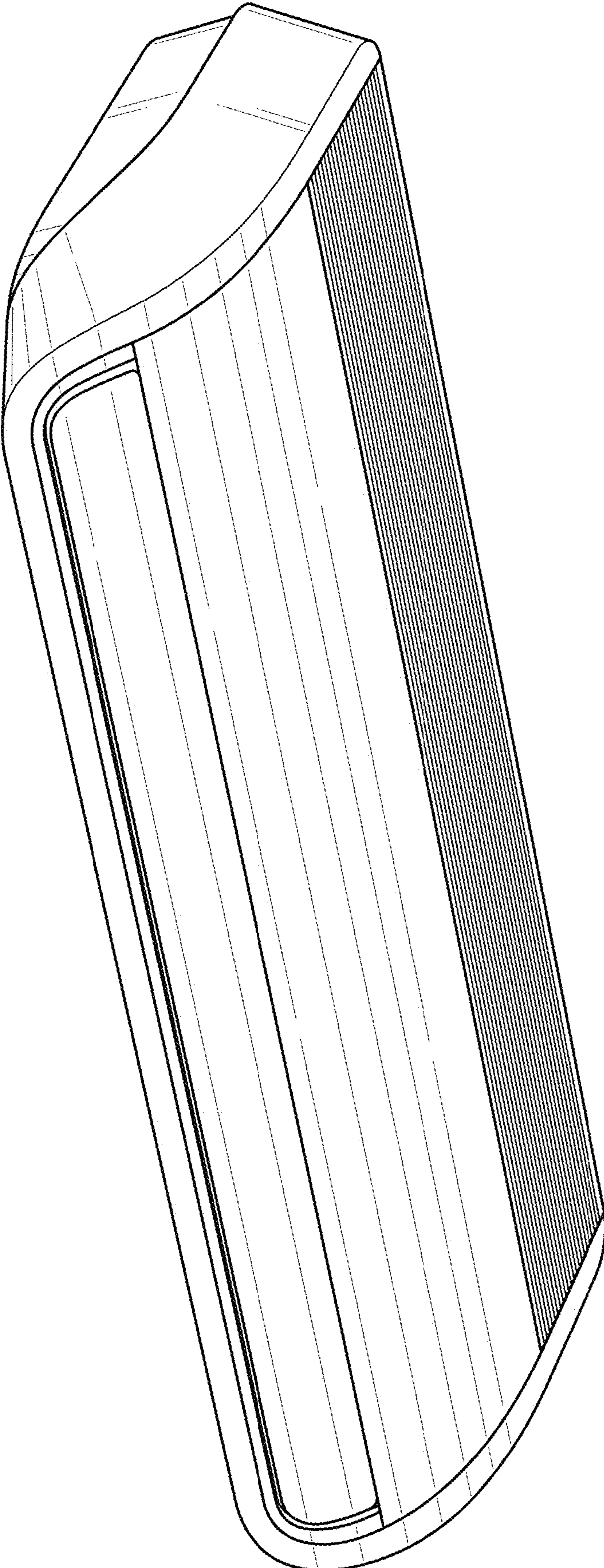

FIG. 17

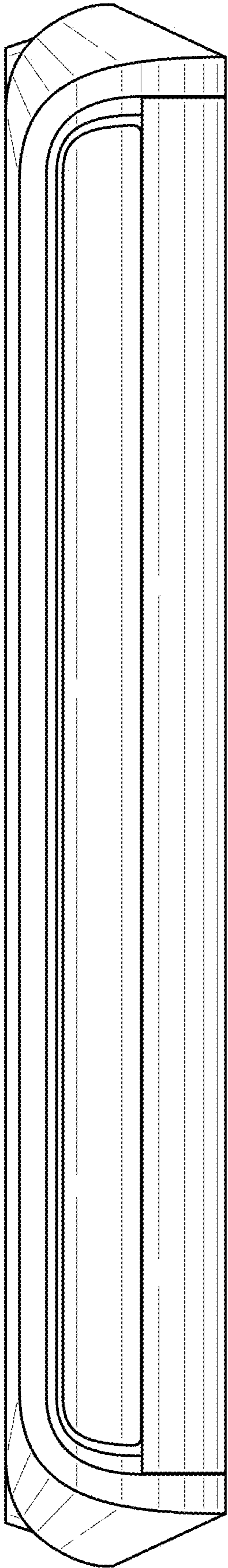

FIG. 18

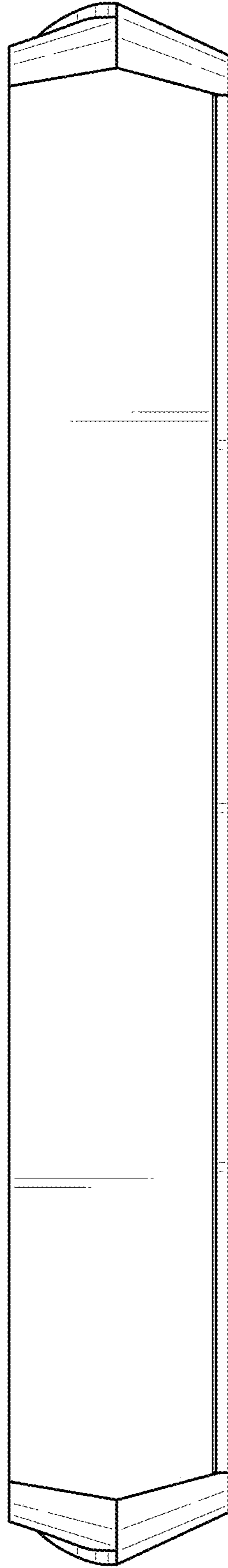

FIG. 19



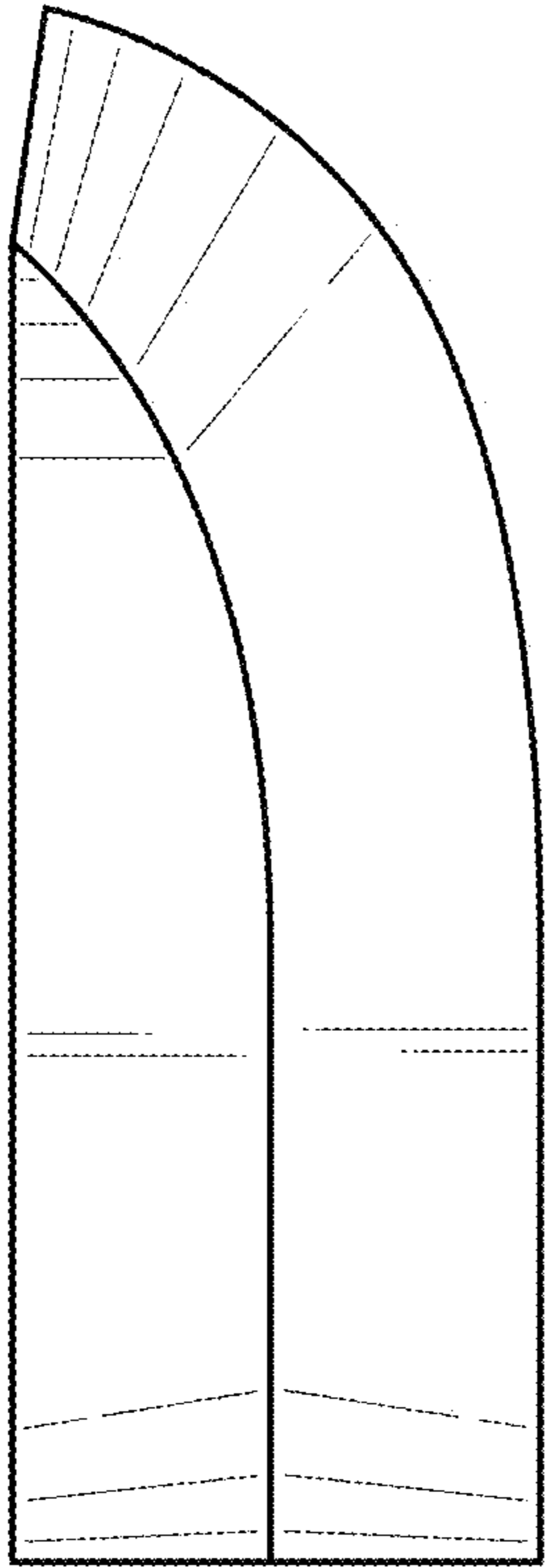

FIG. 20

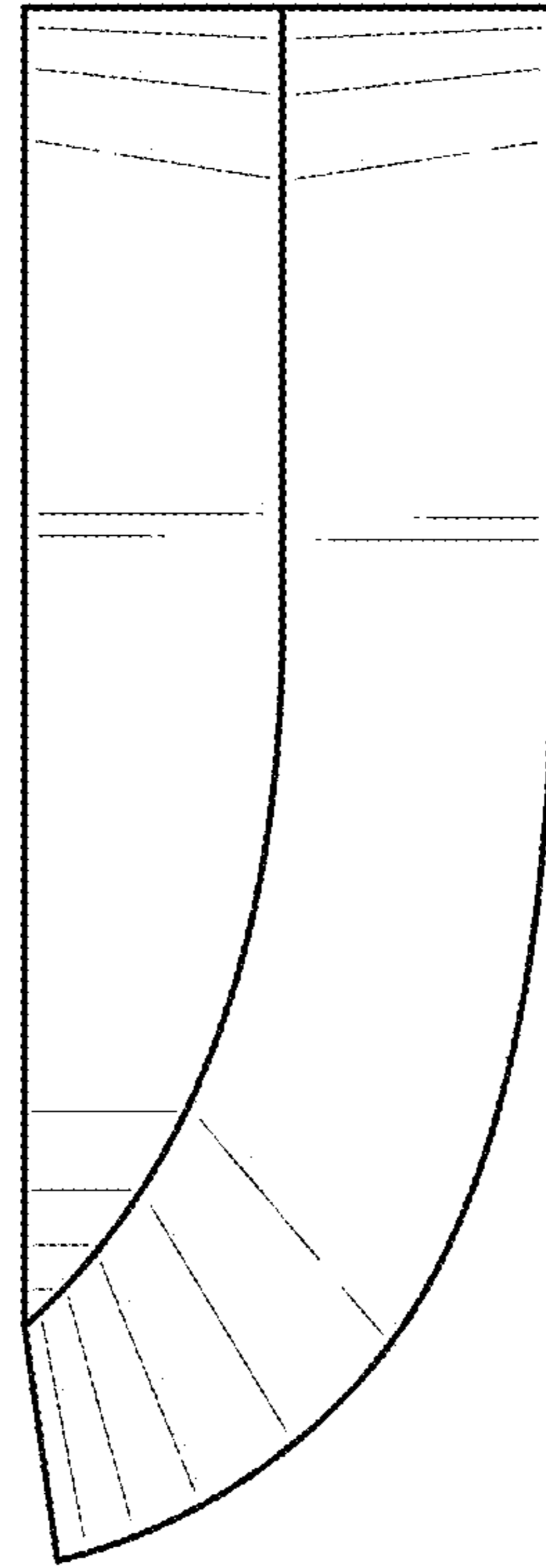

FIG. 21

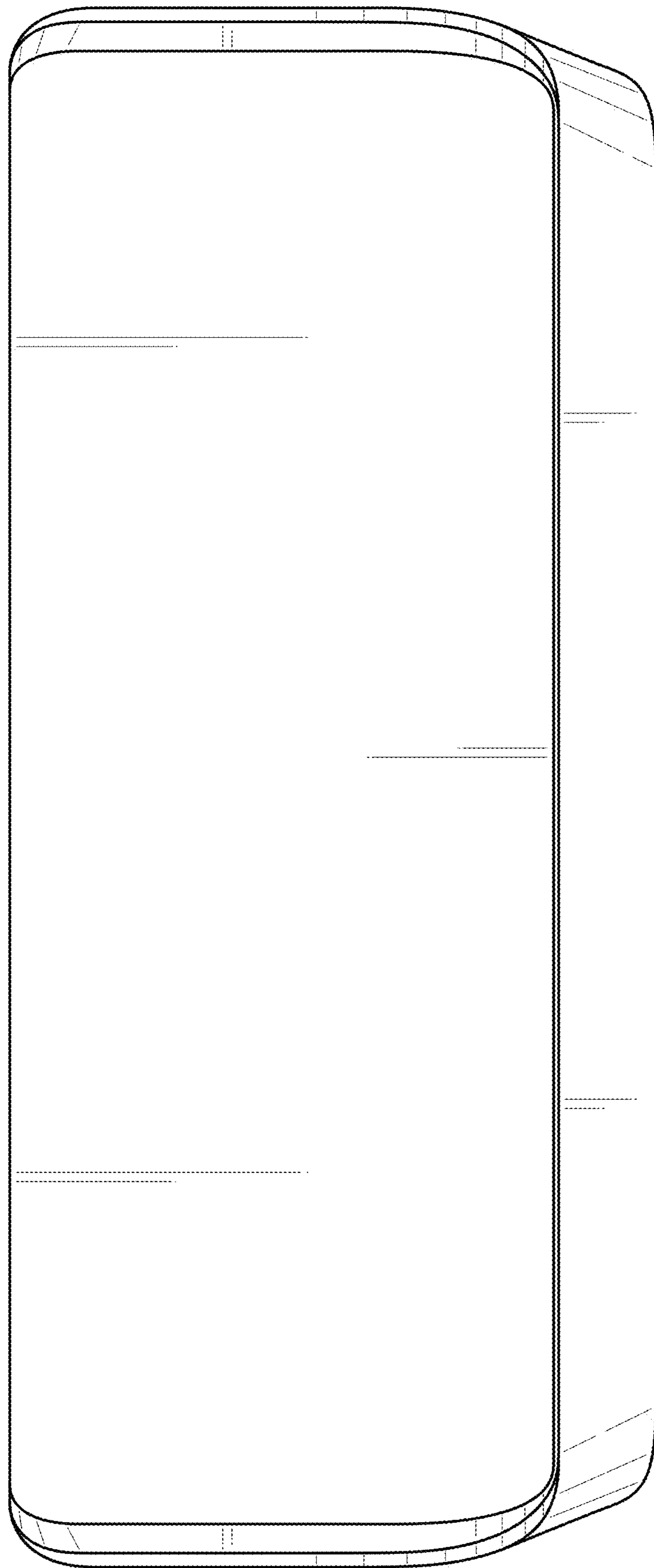

FIG. 22

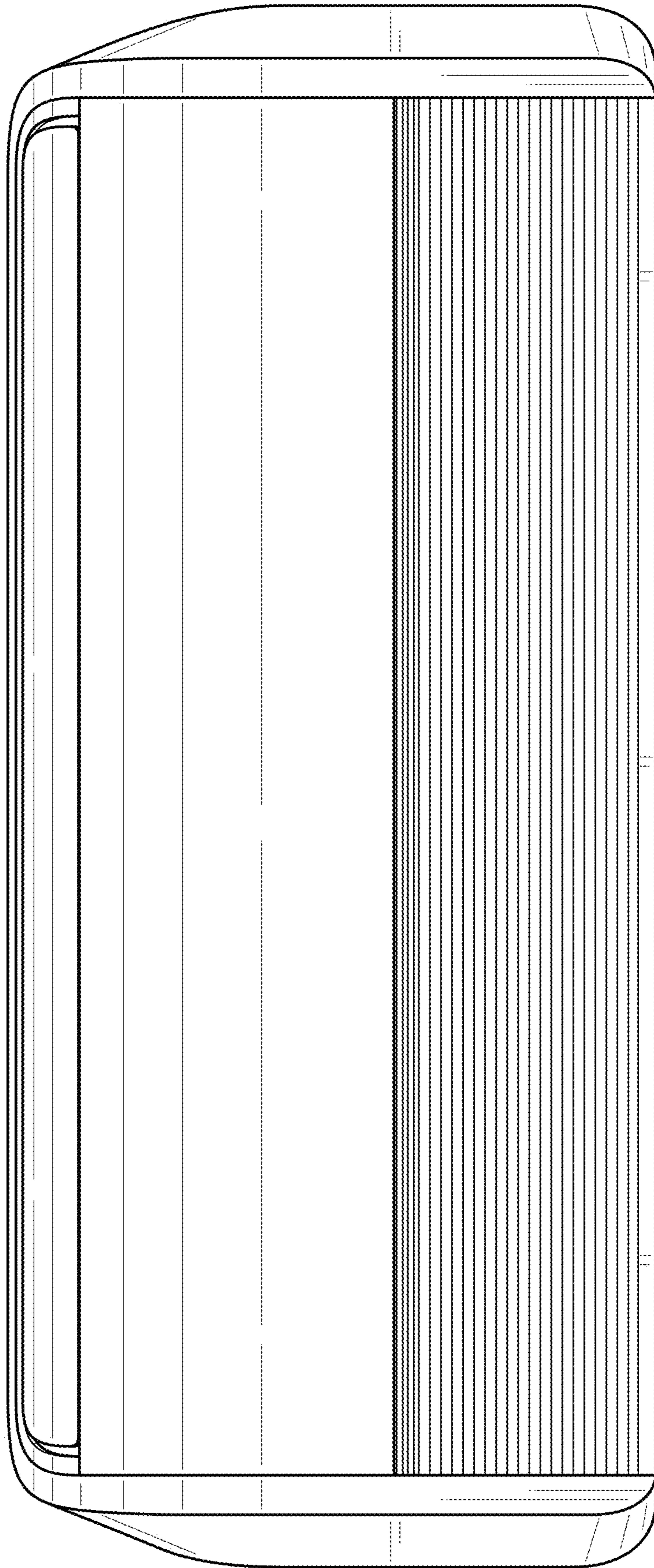

FIG. 23

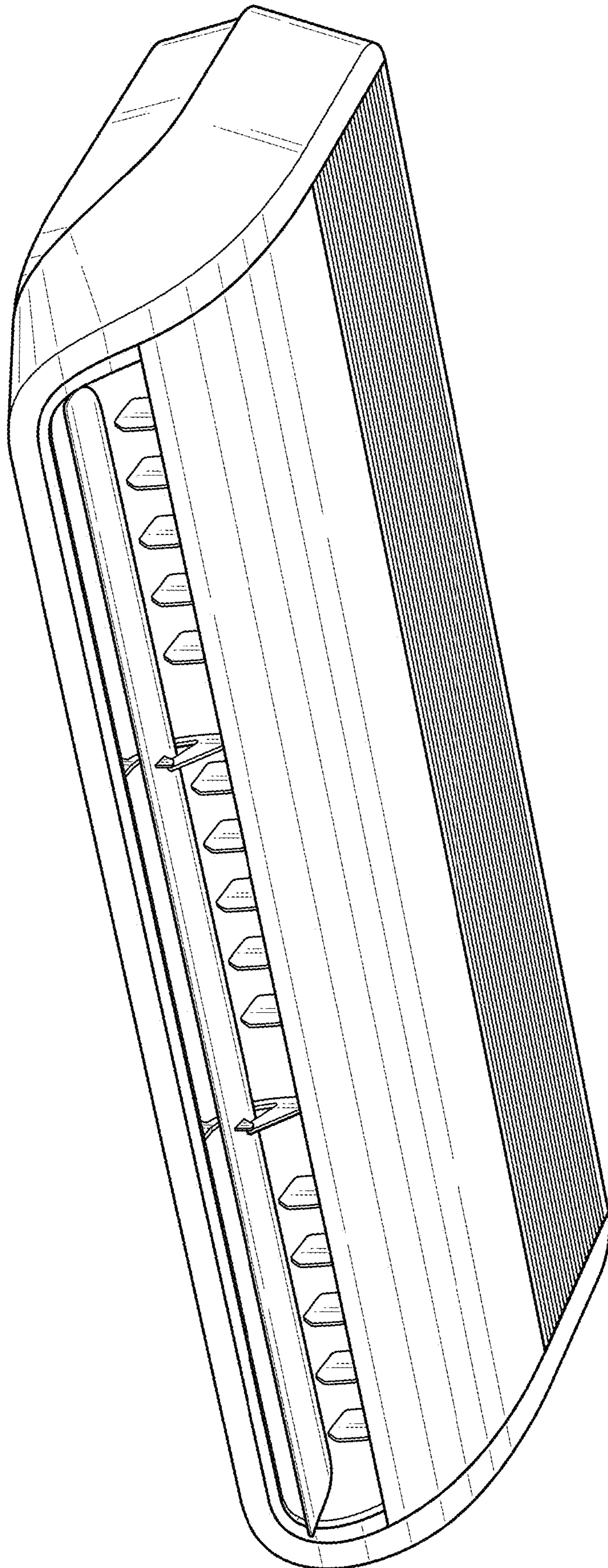

FIG. 24