



US00D915503S

(12) **United States Design Patent** (10) **Patent No.:** **US D915,503 S**  
**Umeda** (45) **Date of Patent:** **\*\* Apr. 6, 2021**

(54) **COIN DEPOSITING AND DISPENSING APPARATUS**

(71) Applicant: **ASAHI SEIKO CO., LTD.**, Tokyo (JP)

(72) Inventor: **Masayoshi Umeda**, Saitama (JP)

(73) Assignee: **ASAHI SEIKO CO., LTD.**, Tokyo (JP)

(\*\*) Term: **15 Years**

(21) Appl. No.: **29/704,218**

(22) Filed: **Sep. 3, 2019**

(30) **Foreign Application Priority Data**

Mar. 4, 2019 (JP) ..... 2019-004444 U

(51) **LOC (13) Cl.** ..... **18-01**

(52) **U.S. Cl.**  
USPC ..... **D18/3.1; D99/34**

(58) **Field of Classification Search**  
USPC ... D18/3.1, 3.2, 3.3, 4.1, 4.4, 12, 12.1, 12.2, D18/12.3, 46, 47, 56, 59, 2, 4.5, 4.6; D14/300, 301, 302, 303, 307, 308, 348, D14/349, 432, 439, 441, 448, 449, 462, D14/469, 471, 900, 901, 902; D10/96, D10/97; D99/28, 34, 35, 43, 99; D19/64, 65, 86, 95, 99, 100; D20/1, 8, 9; D15/122

CPC .. G07D 11/00; G07D 11/009; G07D 11/0093; G07D 11/50; G07D 11/0003; G07D 11/0021; G07D 11/0042; G07D 11/0081; G07D 11/0084; G07D 11/0006; G07D 11/0009; G07D 2207/00; G07D 2211/00; G07D 7/00; G07D 7/04; G07D 9/008; G07G 1/00; G07G 1/0009; G07G 1/0036; G07G 1/10; G07G 1/12; G07F 19/20; G07F 19/205

See application file for complete search history.

(56) **References Cited**

U.S. PATENT DOCUMENTS

D101,388 S \* 9/1936 Moninger ..... D20/1  
D157,583 S \* 3/1950 Frick ..... D20/1  
D158,814 S \* 5/1950 Sundberg et al. .... D14/359  
2,588,190 A \* 3/1952 Wockenfuss ..... 101/93.45  
D189,549 S \* 1/1961 Koci ..... D10/97  
D199,692 S \* 12/1964 Stolarz ..... D10/97  
D207,791 S \* 5/1967 Stein ..... D20/1  
D222,704 S \* 12/1971 Winsett ..... D20/1  
D235,921 S \* 7/1975 Alger et al. .... D18/47  
D235,922 S \* 7/1975 Alger et al. .... D18/47

(Continued)

*Primary Examiner* — Marie D. Fast Horse

(74) *Attorney, Agent, or Firm* — Sughrue Mion, PLLC

(57) **CLAIM**

The ornamental design for a coin depositing and dispensing apparatus, as shown and described.

**DESCRIPTION**

FIG. 1 is a perspective view 1 of a coin depositing and dispensing apparatus showing my new design;  
FIG. 2 is a perspective view 2 thereof;  
FIG. 3 is a perspective view 3 thereof;  
FIG. 4 is a perspective view 4 thereof;  
FIG. 5 is a front view thereof;  
FIG. 6 is a rear view thereof;  
FIG. 7 is a left side view thereof;  
FIG. 8 is a right side view thereof;  
FIG. 9 is a top plan view thereof; and,  
FIG. 10 is a bottom view thereof.

The broken lines depict portions of the coin depositing and dispensing apparatus that form no part of the claimed design.

(Continued)

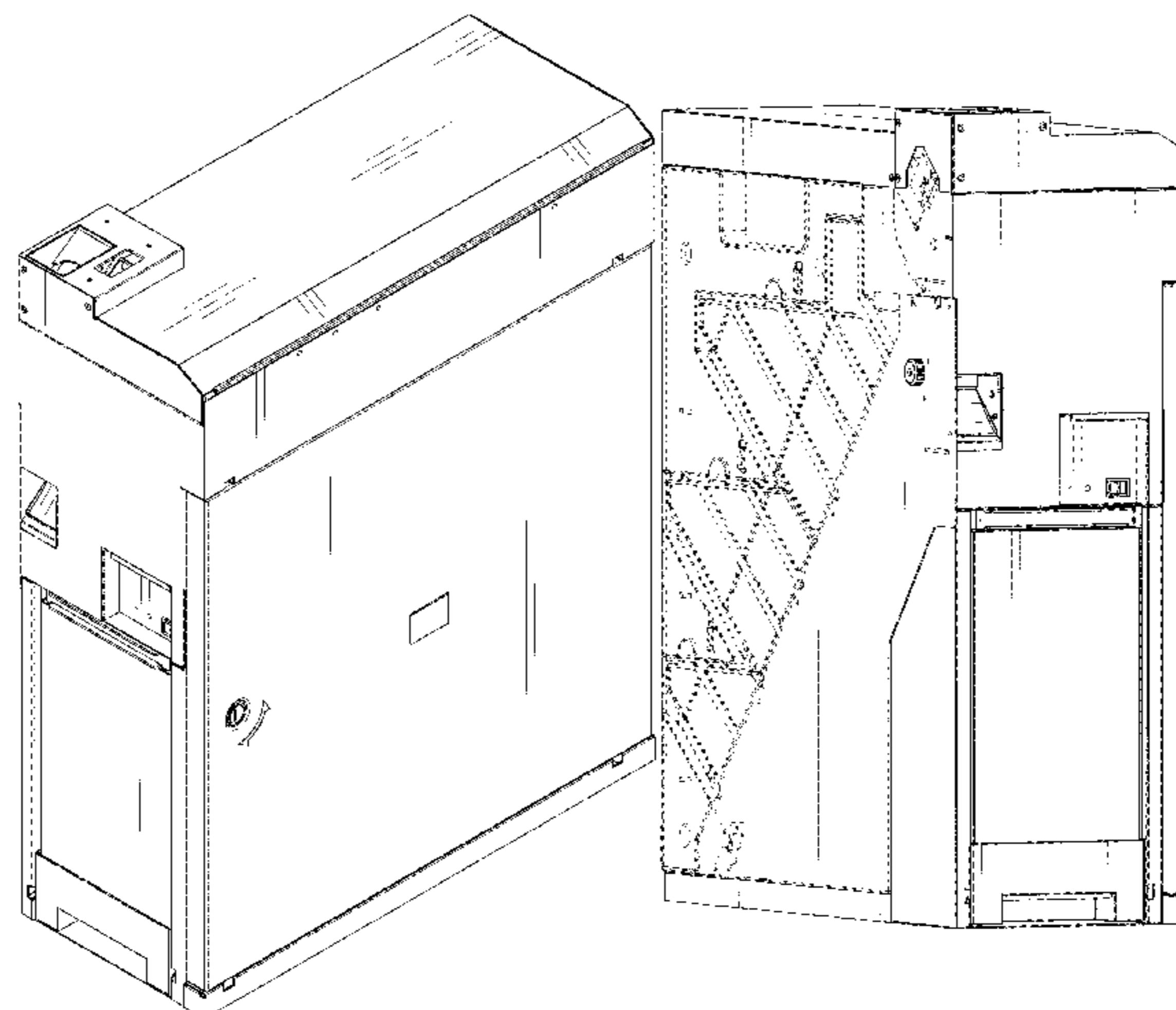

The different shading techniques used depict a contrast of appearance only and does not represent a particular color, material, or texture.

**1 Claim, 10 Drawing Sheets**

(56)

**References Cited**

U.S. PATENT DOCUMENTS

D268,840 S \* 5/1983 Reed ..... D15/82  
 D275,738 S \* 10/1984 Willette ..... D10/97  
 D280,742 S \* 9/1985 Johnson ..... D20/9  
 D282,307 S \* 1/1986 Nishida ..... D18/3.3  
 D292,420 S \* 10/1987 DelPercio ..... D20/1  
 D296,908 S \* 7/1988 Trimble ..... D20/1  
 D321,013 S \* 10/1991 Yukimoto ..... D20/9  
 5,062,598 A \* 11/1991 Winkler ..... G07D 11/26  
 271/6  
 D335,149 S \* 4/1993 Dabrowski ..... D20/1  
 D382,859 S \* 8/1997 Alfonso ..... D14/349  
 D428,045 S \* 7/2000 Stettes ..... D18/3.1  
 D436,120 S \* 1/2001 Nottingham ..... D18/3.1  
 D448,040 S \* 9/2001 Forslund ..... D18/3.1  
 D452,873 S \* 1/2002 Nakao ..... D18/3.1  
 6,460,705 B1 \* 10/2002 Hallowell ..... G07D 11/10  
 209/534  
 6,601,687 B1 \* 8/2003 Jenrick ..... G07D 11/13  
 194/206  
 6,860,375 B2 \* 3/2005 Hallowell ..... G07D 7/00  
 194/328  
 D523,468 S \* 6/2006 Umeda ..... D18/3.1  
 D533,870 S \* 12/2006 Kumano ..... D14/349  
 D537,442 S \* 2/2007 Lauffer ..... D14/349  
 D540,391 S \* 4/2007 Irie ..... D20/9  
 D541,870 S \* 5/2007 Tandberg ..... D20/1  
 D547,380 S \* 7/2007 Pfeiffer ..... D20/1  
 D574,420 S \* 8/2008 Gaze ..... D14/308  
 D574,421 S \* 8/2008 Gaze ..... D14/308  
 D608,779 S \* 1/2010 Chen ..... D14/349  
 D618,875 S \* 6/2010 Tougo ..... D99/28  
 D624,066 S \* 9/2010 Samsonsen ..... D14/308  
 D626,171 S \* 10/2010 Von Heifner ..... D18/3.1  
 D650,007 S \* 12/2011 Inage ..... D18/3.3  
 D652,444 S \* 1/2012 Inage ..... D18/3.3  
 8,210,429 B1 \* 7/2012 Bohlen ..... G07F 19/209  
 235/385  
 D669,525 S \* 10/2012 Bleck ..... D18/3.3  
 D671,164 S \* 11/2012 Bleck ..... D18/3.3  
 D674,020 S \* 1/2013 Hecht ..... D20/1  
 D686,663 S \* 7/2013 Bruck ..... D20/1  
 D690,330 S \* 9/2013 Tsuchiyama ..... D15/122  
 D724,813 S \* 3/2015 Umeda ..... D99/34  
 D725,865 S \* 3/2015 Cho ..... D99/28  
 8,973,817 B1 \* 3/2015 Daniel, III ..... B65H 1/022  
 235/379

D744,996 S \* 12/2015 Keisling ..... D14/308  
 D766,540 S \* 9/2016 Lee ..... D99/28  
 D767,239 S \* 9/2016 Umeda ..... D99/34  
 D774,722 S \* 12/2016 Yeon ..... D99/28  
 D776,399 S \* 1/2017 Yeon ..... D99/28  
 D782,148 S \* 3/2017 Rohan ..... D99/28  
 D803,507 S \* 11/2017 Park ..... D99/28  
 D810,189 S \* 2/2018 Enomoto ..... D18/3.1  
 D844,045 S \* 3/2019 Umeda ..... D18/3.1  
 D844,048 S \* 3/2019 Abe ..... D18/12.1  
 D850,524 S \* 6/2019 Oba ..... D18/3.3  
 D871,499 S \* 12/2019 Kuroda ..... D18/3.3  
 D874,569 S \* 2/2020 Tumblety ..... D20/1  
 D879,873 S \* 3/2020 Takahashi ..... D18/3.3  
 D879,878 S \* 3/2020 Mao ..... D20/1  
 D883,604 S \* 5/2020 Block ..... D99/28  
 D892,217 S \* 8/2020 Tumblety ..... D20/1  
 2003/0201146 A1 \* 10/2003 Abe ..... G07D 1/02  
 194/302  
 2003/0221933 A1 \* 12/2003 Morikawa ..... G07D 5/00  
 194/302  
 2007/0149102 A1 \* 6/2007 Umeda ..... G07D 9/008  
 453/56  
 2008/0047801 A1 \* 2/2008 Nakatsuka ..... G07D 11/26  
 194/206  
 2008/0053786 A1 \* 3/2008 Oie ..... G06Q 20/203  
 194/206  
 2009/0071793 A1 \* 3/2009 Nagase ..... G07D 9/02  
 194/215  
 2009/0120760 A1 \* 5/2009 Sjostrom ..... G07D 9/008  
 194/302  
 2010/0303332 A1 \* 12/2010 Miki ..... G07D 11/50  
 382/135  
 2012/0005073 A1 \* 1/2012 Gnorski ..... G06Q 20/10  
 705/39  
 2012/0012436 A1 \* 1/2012 Nakamoto ..... B65H 29/006  
 194/215  
 2013/0035024 A1 \* 2/2013 Okawa ..... 453/18  
 2013/0256987 A1 \* 10/2013 Miki ..... G07D 11/50  
 271/264  
 2014/0030972 A1 \* 1/2014 Bengtsson ..... G07D 9/008  
 453/3  
 2014/0030973 A1 \* 1/2014 Bengtsson ..... G07D 1/00  
 453/18  
 2014/0031974 A1 \* 1/2014 Ingvarsson ..... G07D 1/00  
 700/232  
 2016/0300399 A1 \* 10/2016 Matsuno ..... G07F 9/04  
 2017/0270737 A1 \* 9/2017 Sakamoto ..... G07F 7/04  
 2018/0300990 A1 \* 10/2018 Kim ..... G07D 11/18  
 2019/0073851 A1 \* 3/2019 Umeda ..... G07D 1/00  
 2019/0122478 A1 \* 4/2019 Sanda ..... G07D 7/17  
 2019/0139350 A1 \* 5/2019 Kuroda ..... G07D 11/34  
 2019/0325711 A1 \* 10/2019 Clauser ..... G06F 13/4282  
 2020/0035055 A1 \* 1/2020 Razzaboni ..... G07D 3/00  
 2020/0372745 A1 \* 11/2020 Onishi ..... G07F 19/202

\* cited by examiner

FIG. 1

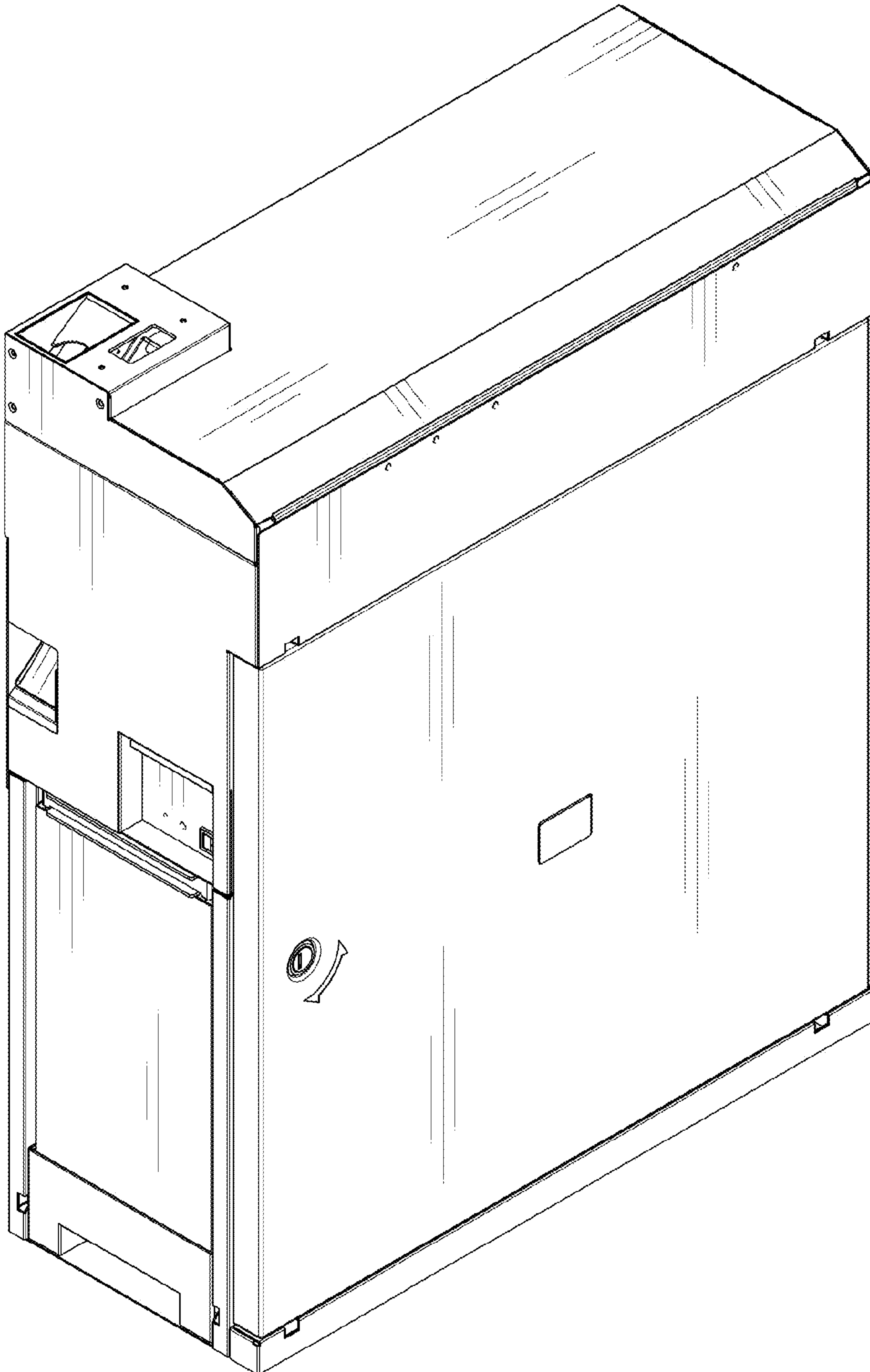

FIG. 2

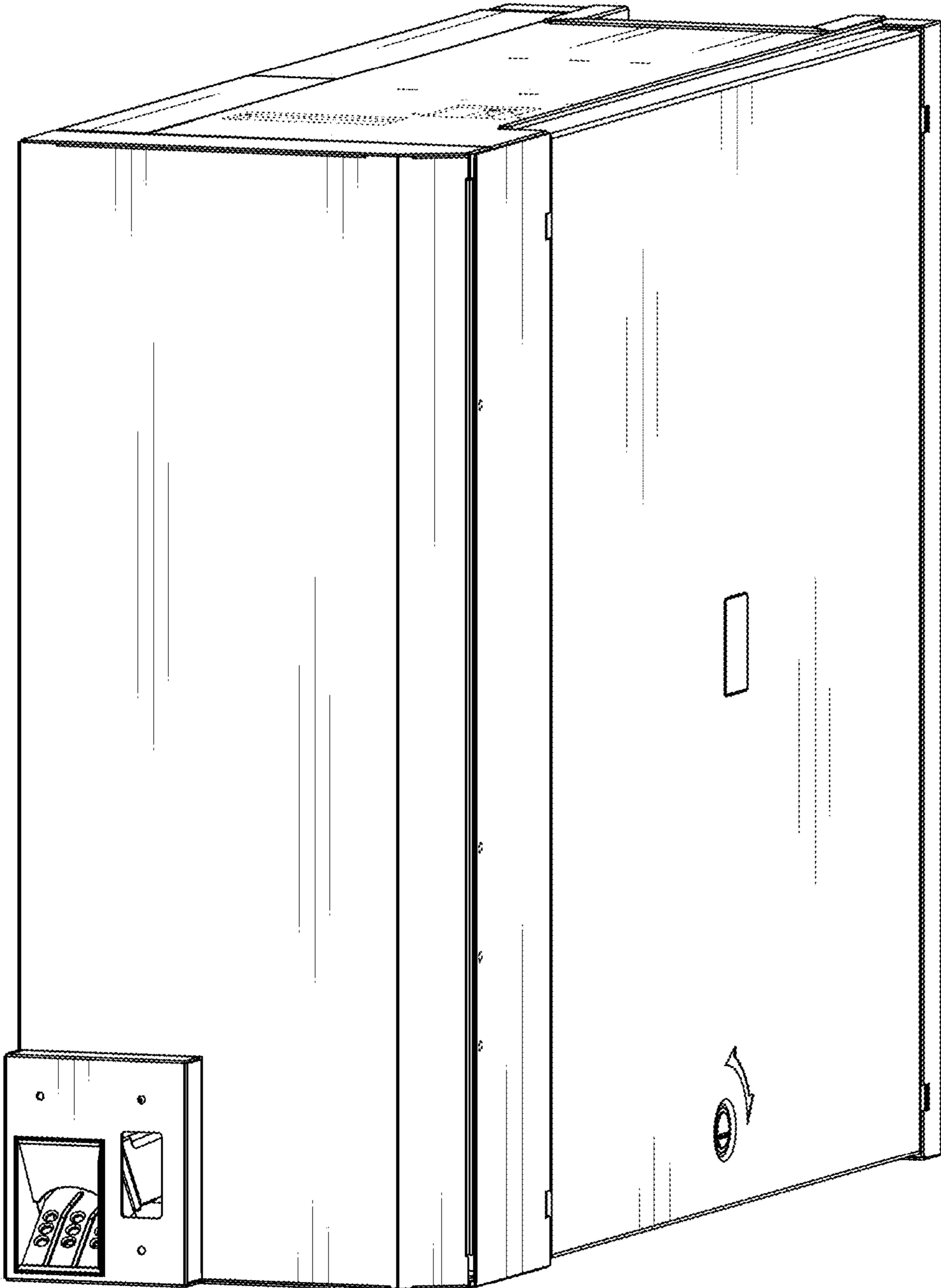

FIG. 3

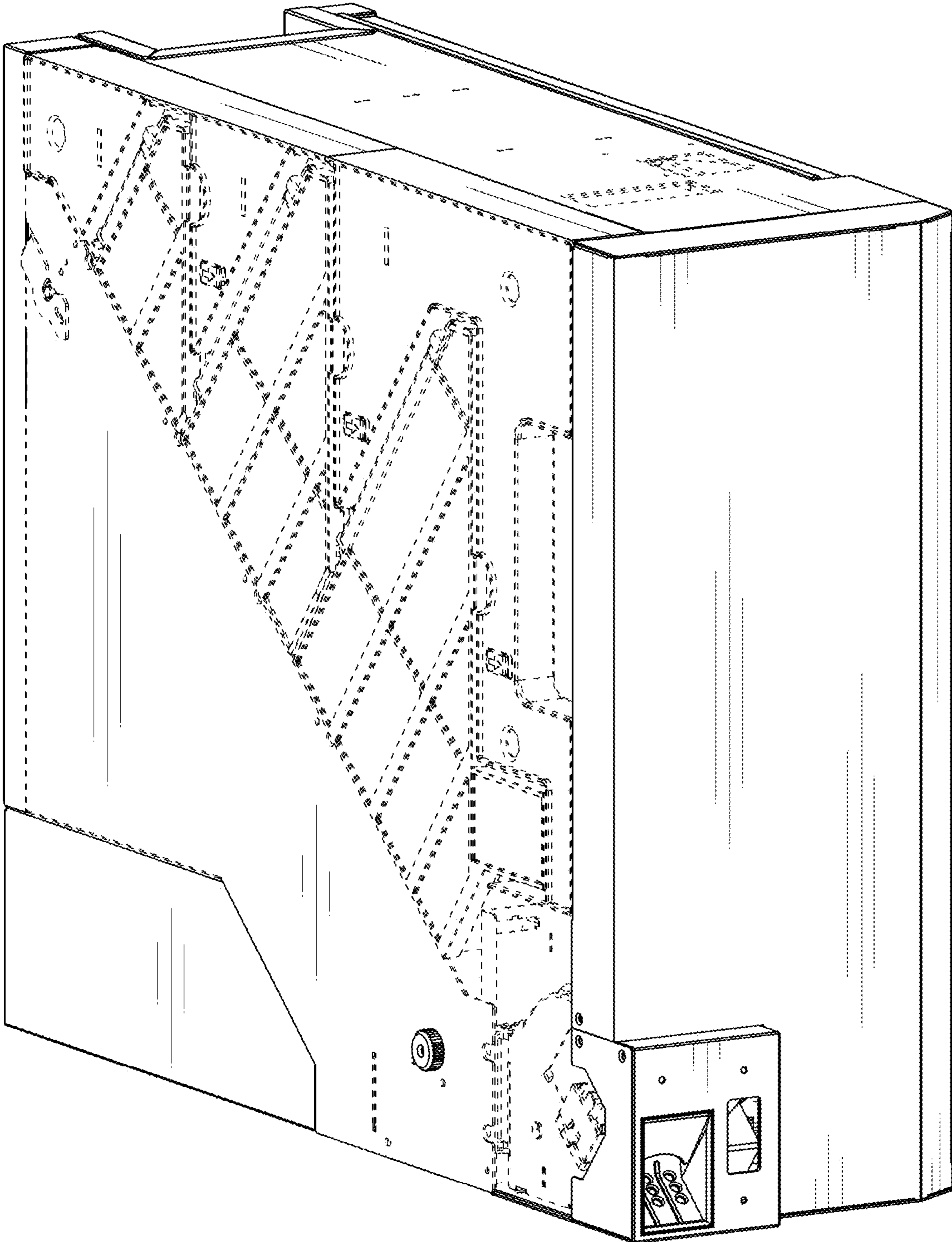

FIG. 4

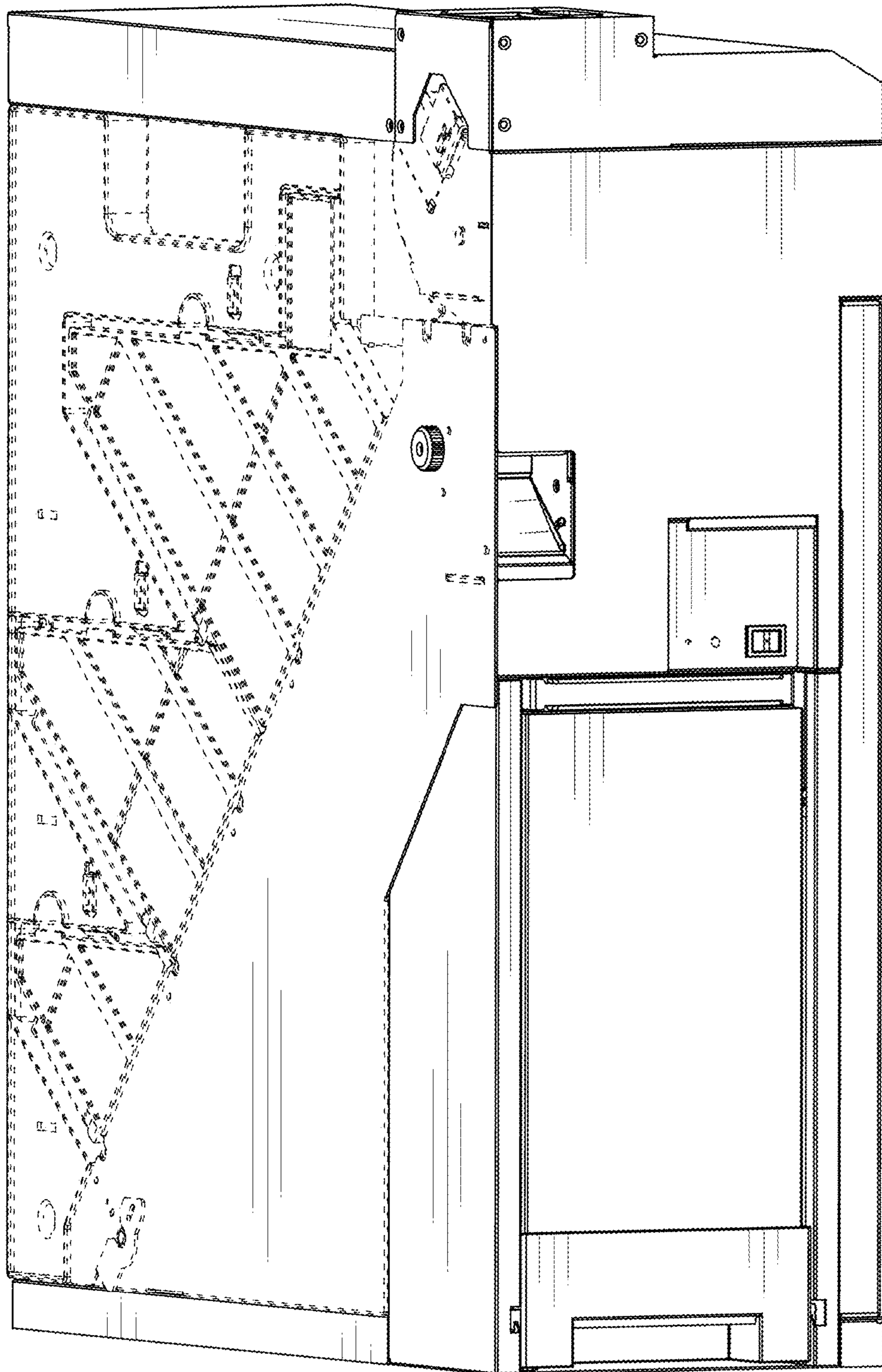

FIG. 5

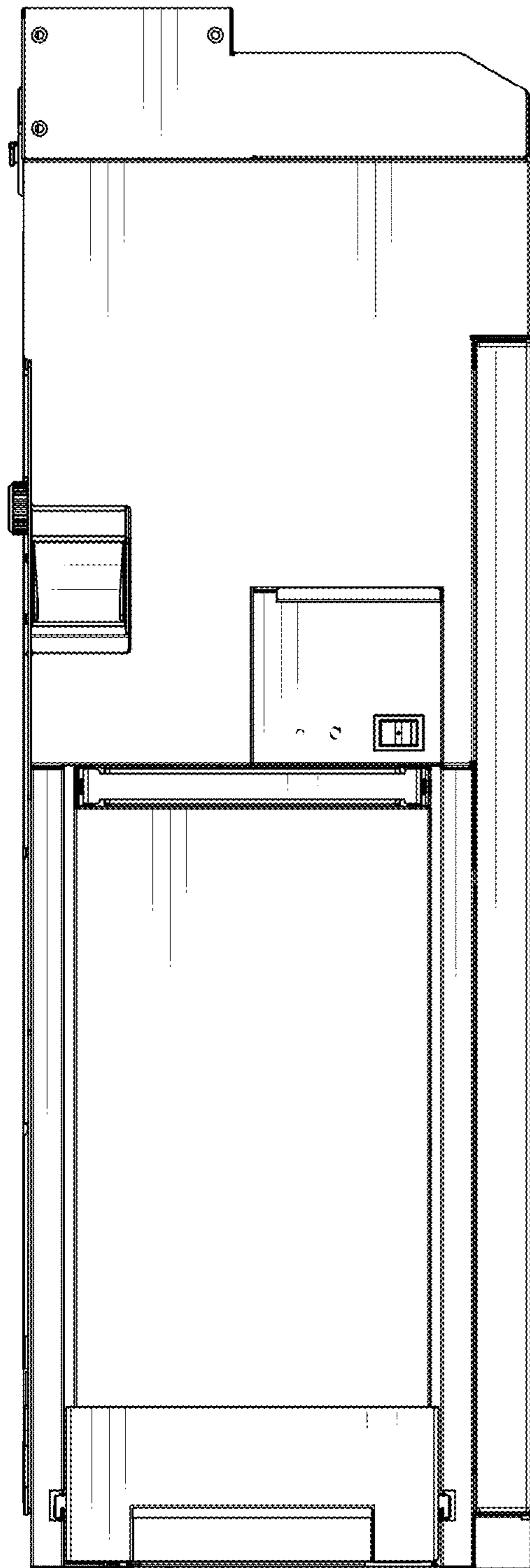

FIG. 6

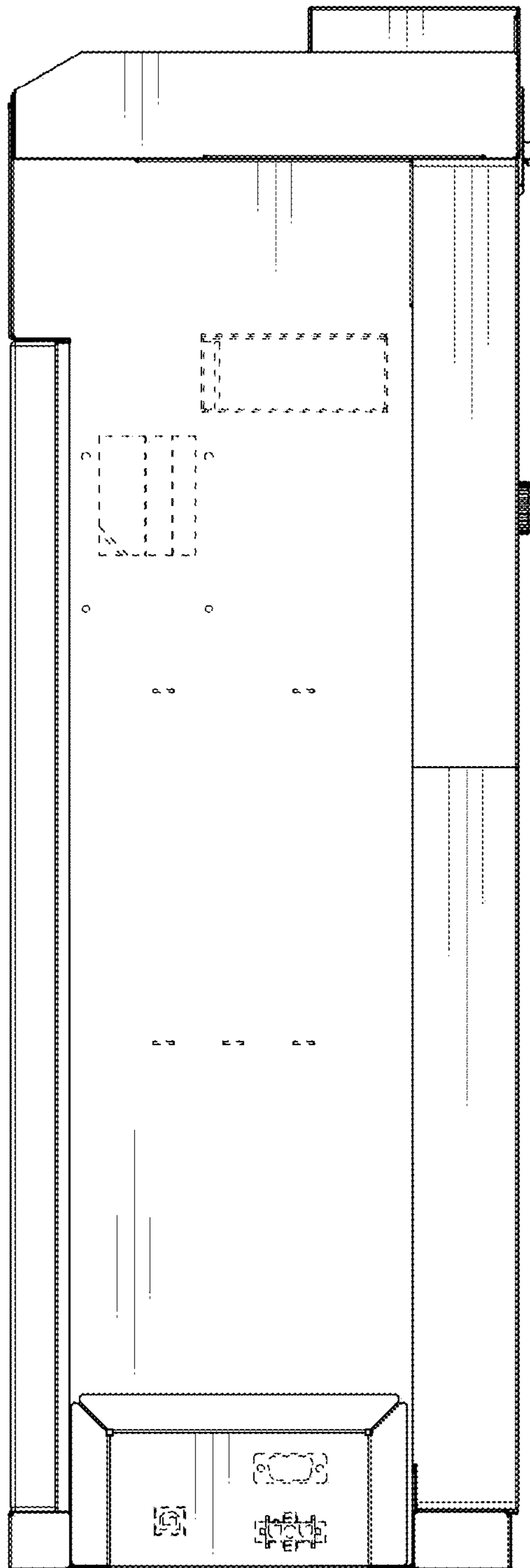



FIG. 7

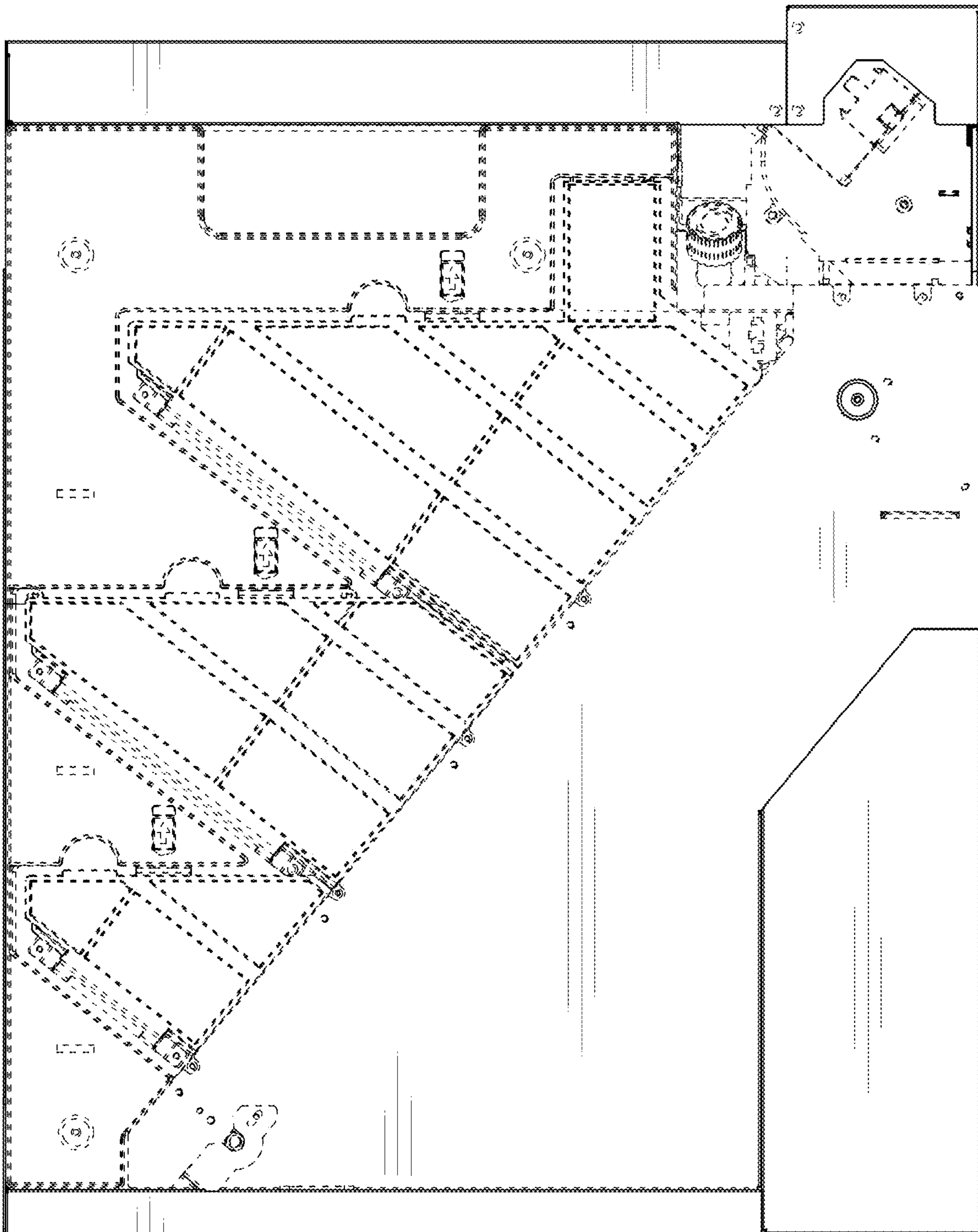

FIG. 8

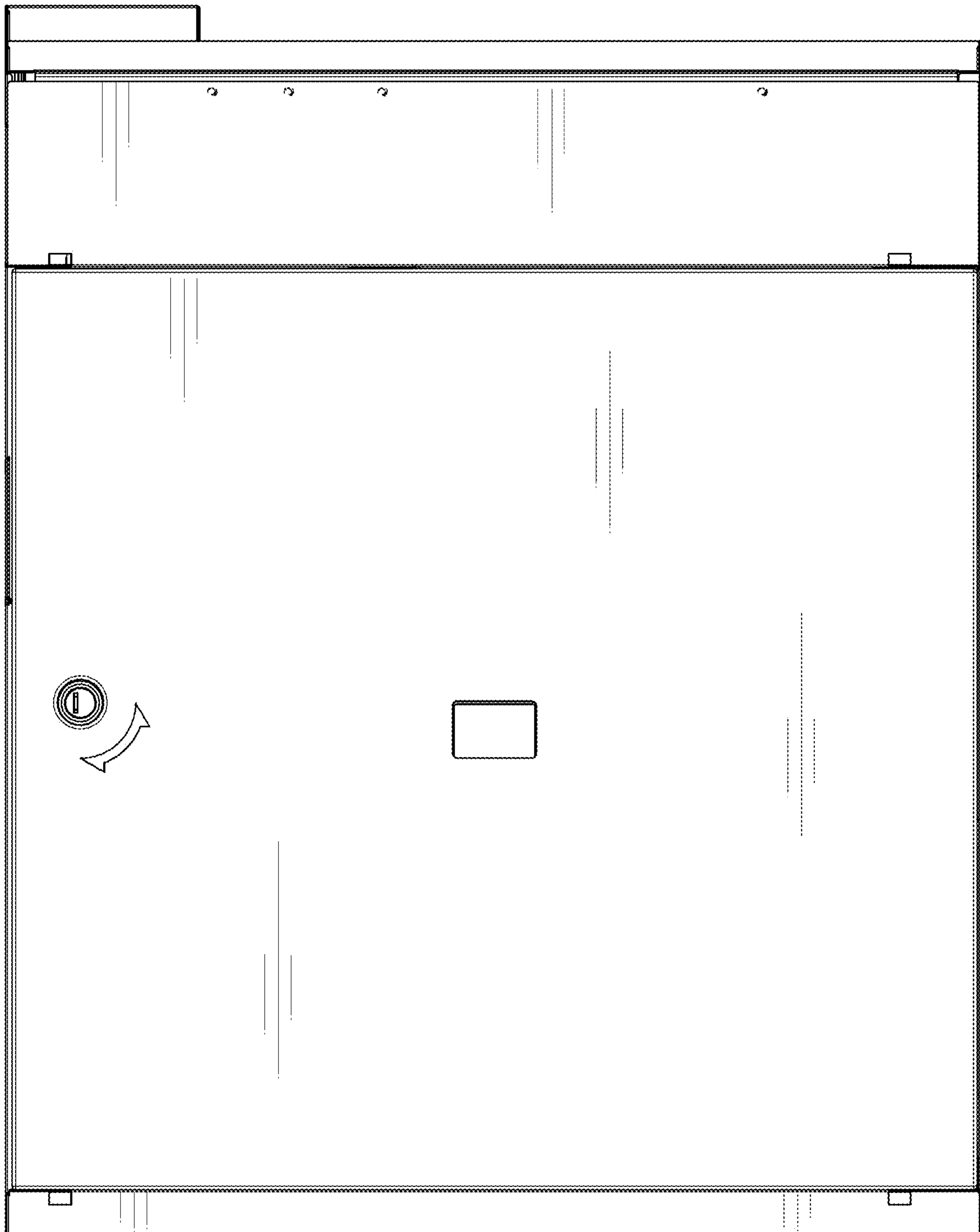

FIG. 9

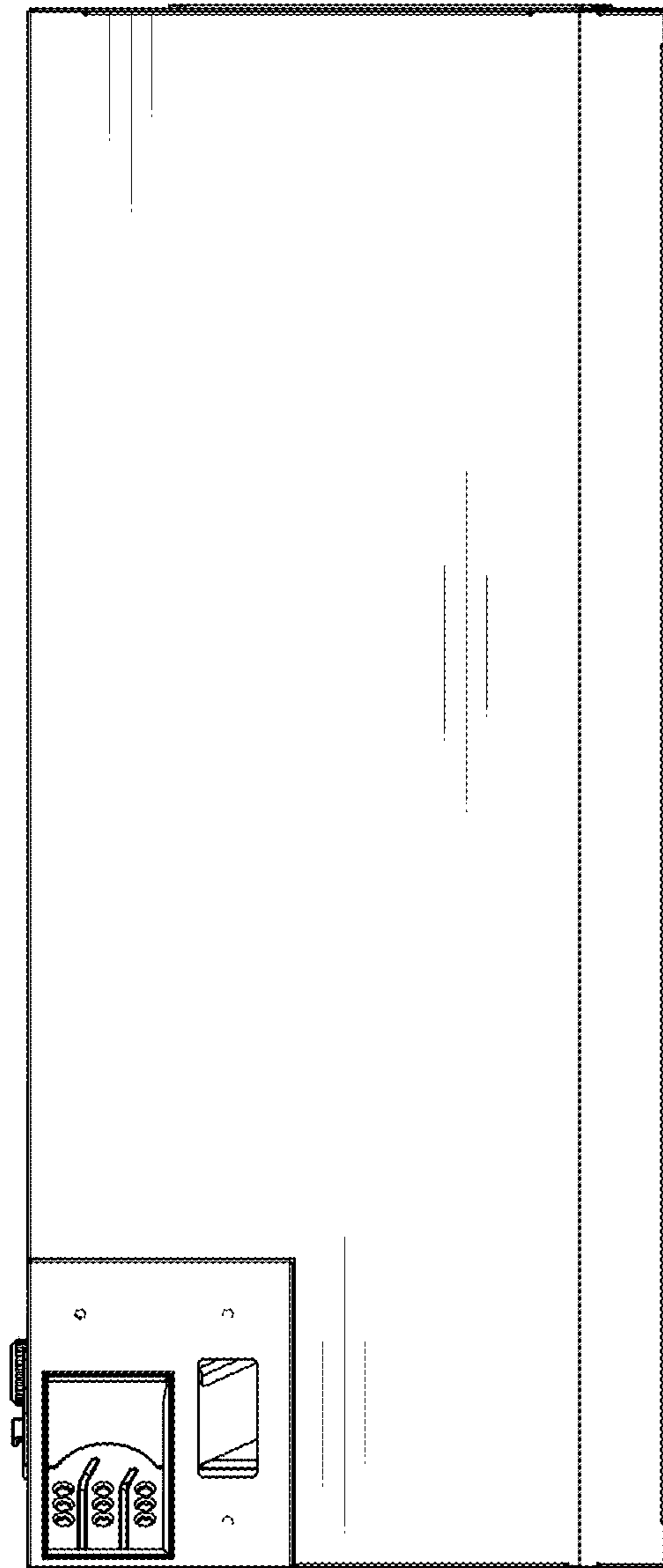

FIG. 10

