



US00D915413S

(12) **United States Design Patent** (10) **Patent No.:** **US D915,413 S**
Lou (45) **Date of Patent:** **** Apr. 6, 2021**

(54) **SUPPORT FOR MOBILE PHONE**
(71) Applicant: **Ningbo Lede Computer Technology Co., Ltd., Zhejiang (CN)**
(72) Inventor: **Yuman Lou, Zhejiang (CN)**
(73) Assignee: **Ningbo Lede Computer Technology Co., Ltd., Zhejiang (CN)**
(**) Term: **15 Years**
(21) Appl. No.: **29/719,543**
(22) Filed: **Jan. 6, 2020**
(51) **LOC (13) Cl.** **08-07**
(52) **U.S. Cl.**
USPC **D14/447**
(58) **Field of Classification Search**
USPC D14/447, 432, 434, 439, 440, 451, 452, D14/457, 239, 253; D8/363, 373, 380; D6/406.3, 406.4, 406.5, 406.6; D12/415
CPC A47B 21/04; A47B 2097/006; A47B 2097/005; A47B 2023/049; A45C 2011/002; A45C 2011/003; F16M 2200/00; F16M 13/00
See application file for complete search history.

D884,711 S * 5/2020 Zhang D14/447
D888,065 S * 6/2020 Ahn D14/447
D896,234 S * 9/2020 Garrity, III D14/447
D898,017 S * 10/2020 Zhang D14/253

* cited by examiner

Primary Examiner — Angela J Lee
(74) *Attorney, Agent, or Firm* — Greensfelder, Hemker & Gale, P.C.; Richard C. Himelhoch

(57) **CLAIM**

I claim the ornamental design for a support for mobile phone, as shown and described.

DESCRIPTION

FIG. 1 is a front side perspective view of a support for mobile phone in accordance with the present design; FIG. 2 is a back side perspective view of the support for mobile phone of FIG. 1; FIG. 3 is a front side plan view of the support for mobile phone of FIG. 1; FIG. 4 is a back side plan view of the support for mobile phone of FIG. 1; FIG. 5 is a left side plan view of the support for mobile phone of FIG. 1; FIG. 6 is a right side plan view of the support for mobile phone of FIG. 1; FIG. 7 is a top plan view of the support for mobile phone of FIG. 1; and, FIG. 8 is a bottom plan view of the support for mobile phone of FIG. 1.
Directional terms (such as top, bottom, etc.) are made with regard to the support for mobile phone as shown and positioned in the drawings and are not intended to limit the scope of the invention.

1 Claim, 8 Drawing Sheets

(56) **References Cited**
U.S. PATENT DOCUMENTS
D672,782 S * 12/2012 Gross D14/447
D690,306 S * 9/2013 Malisse D14/447
D692,899 S * 11/2013 Bremenkamp D14/447
D748,099 S * 1/2016 Heid D14/447
D769,235 S * 10/2016 Li D14/253
D857,704 S * 8/2019 Verschoor D14/447
D861,002 S * 9/2019 Bergeron-Mirsky D14/447
D861,701 S * 10/2019 Benoni D14/447
D881,201 S * 4/2020 Lou D14/447

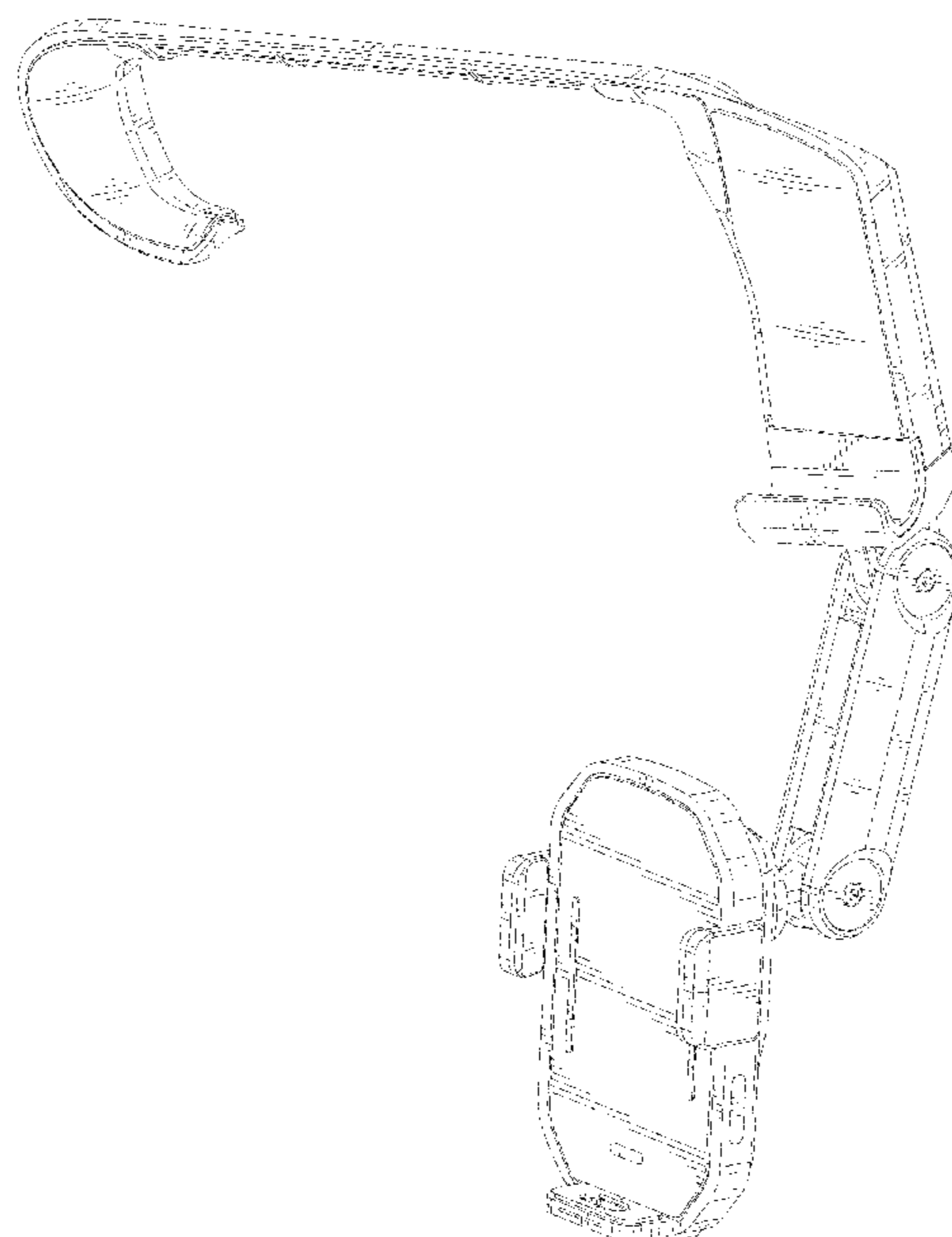

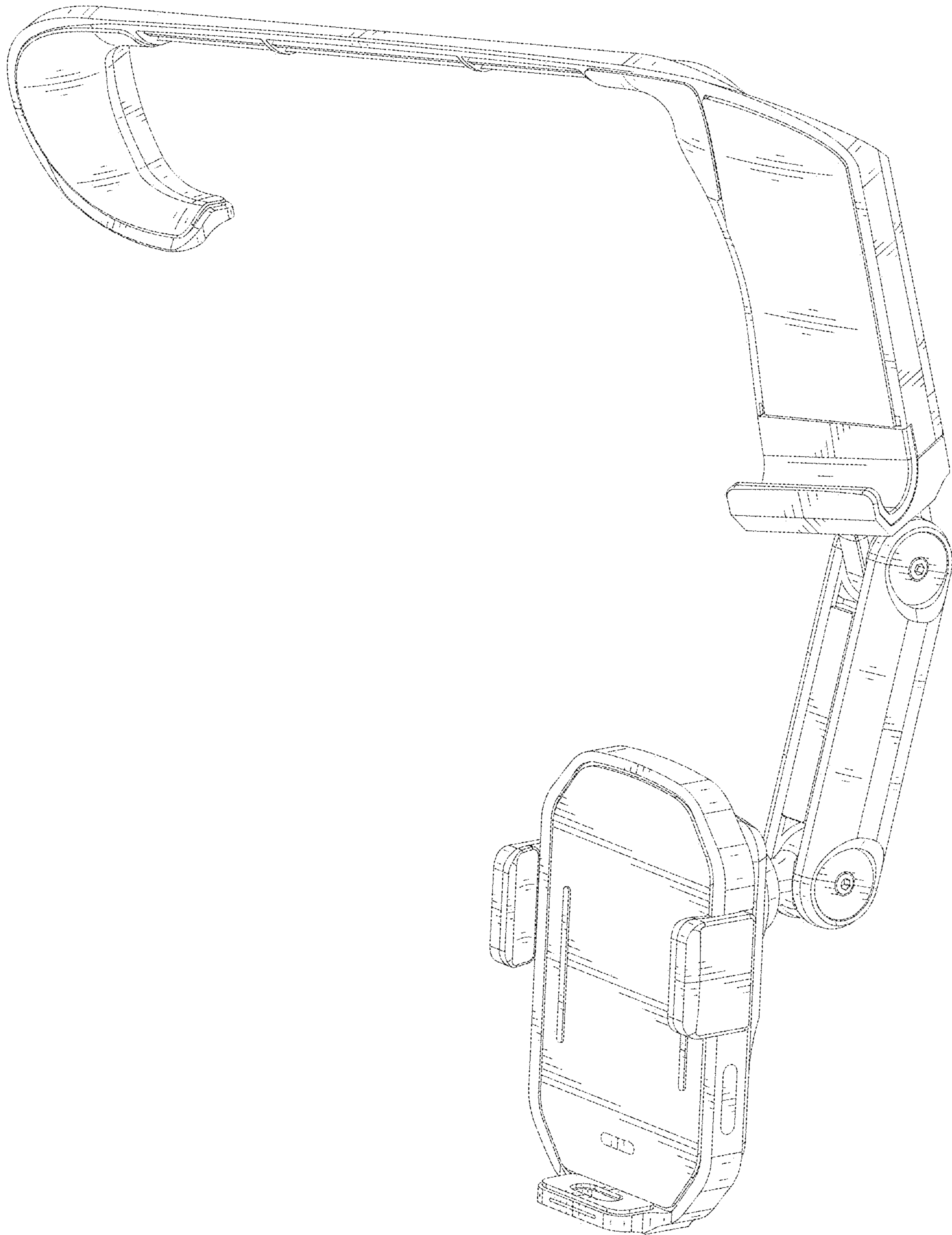

FIG. 1

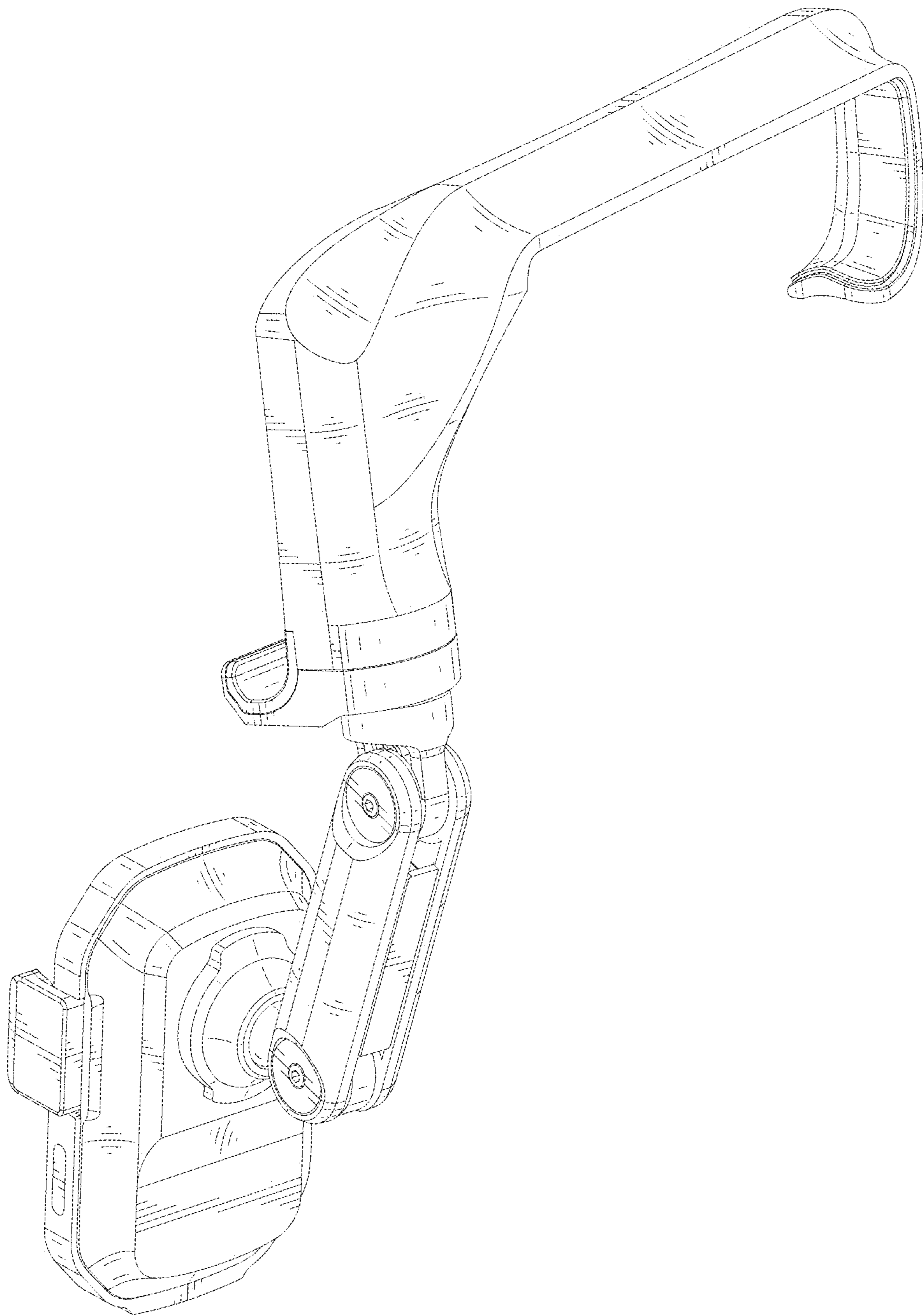

FIG. 2

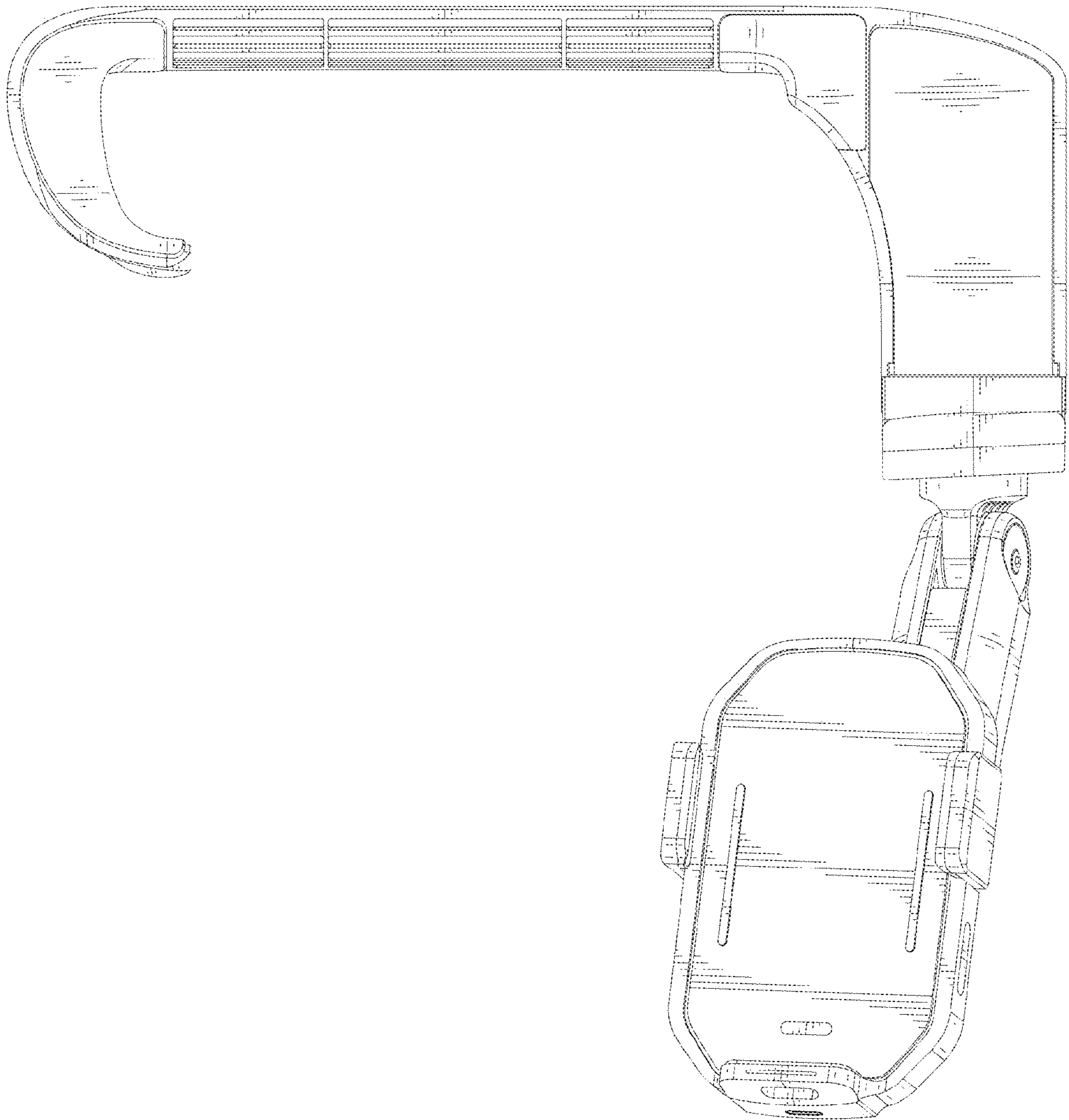

FIG. 3

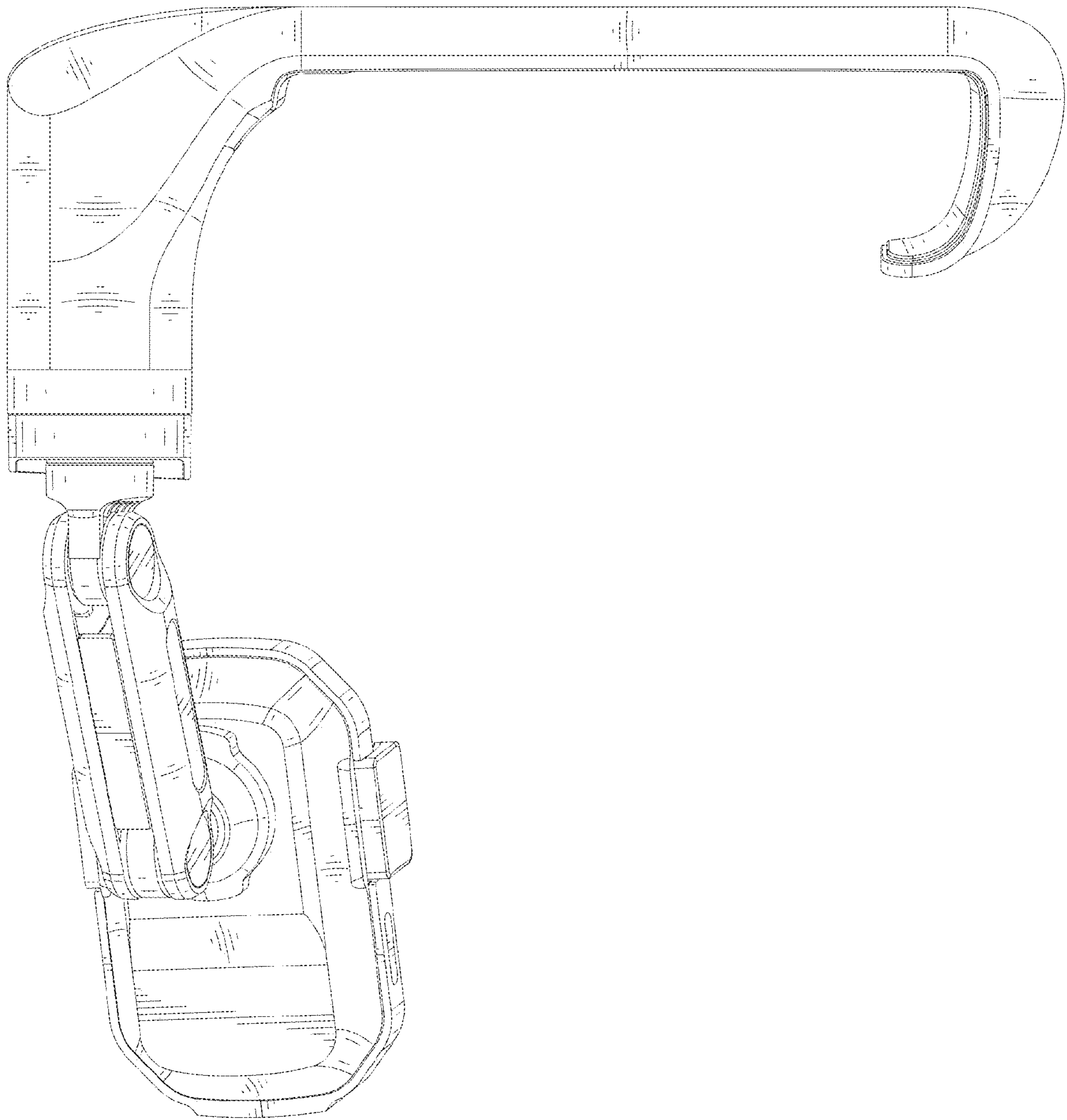

FIG. 4

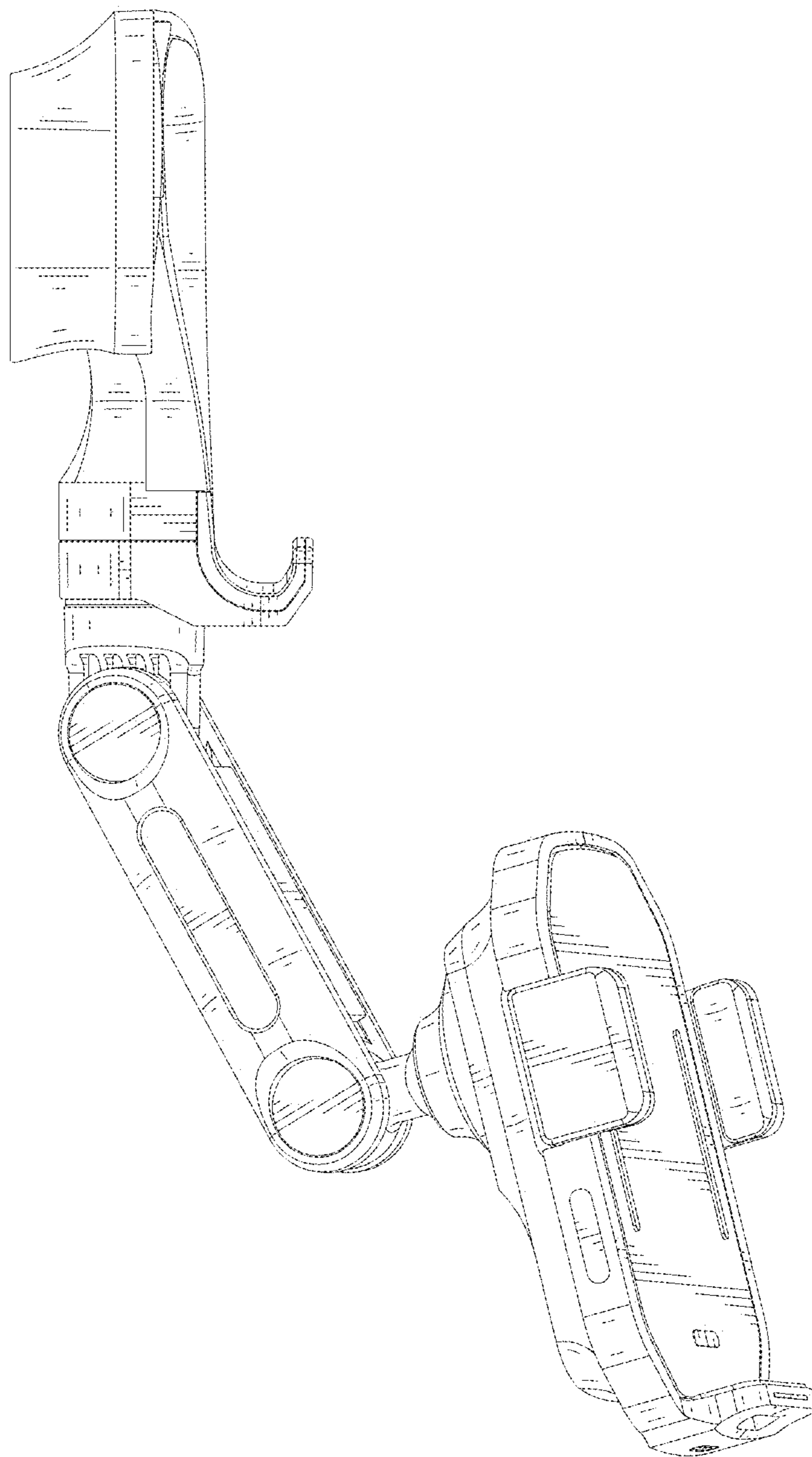

FIG. 5

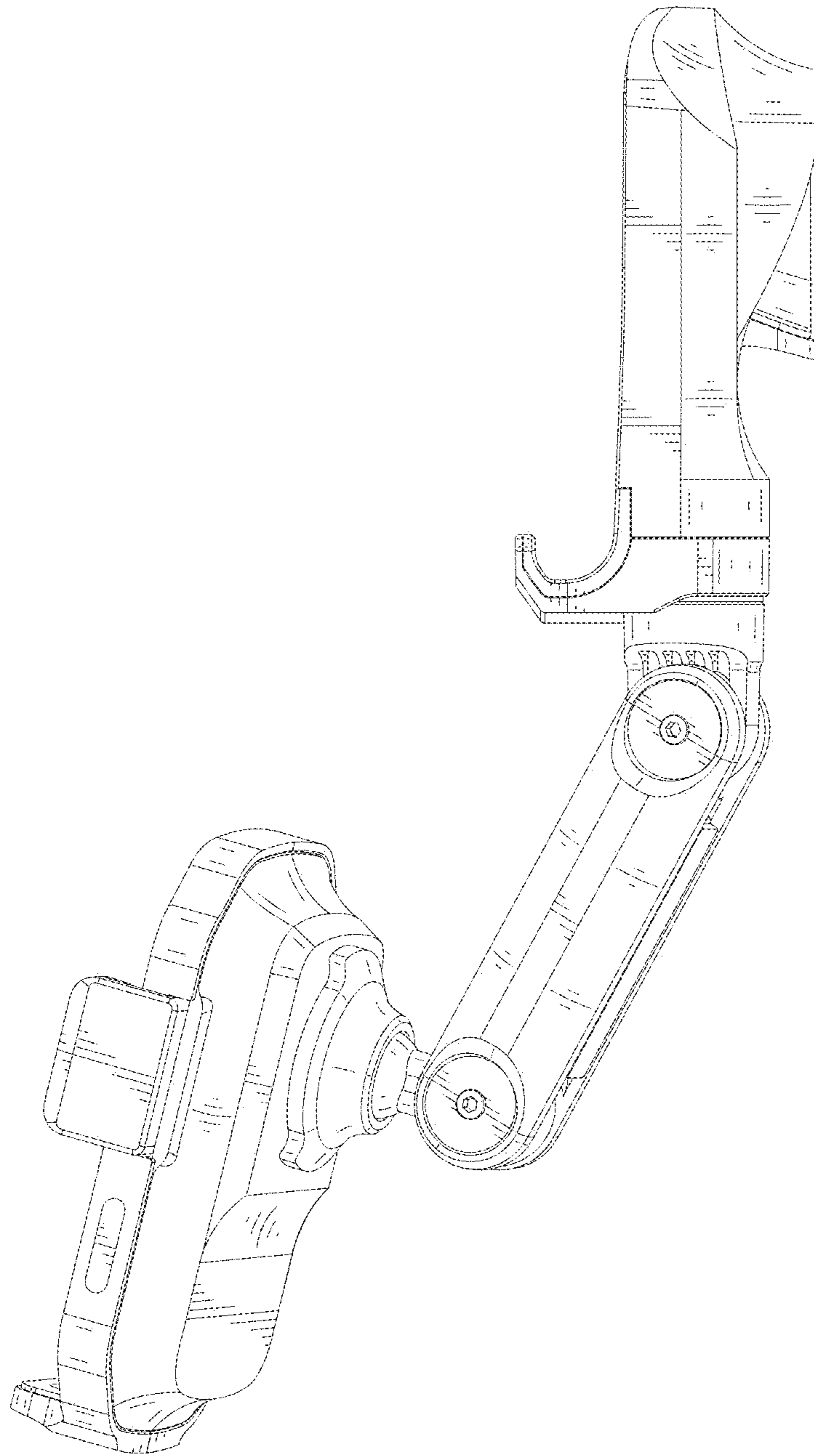

FIG. 6

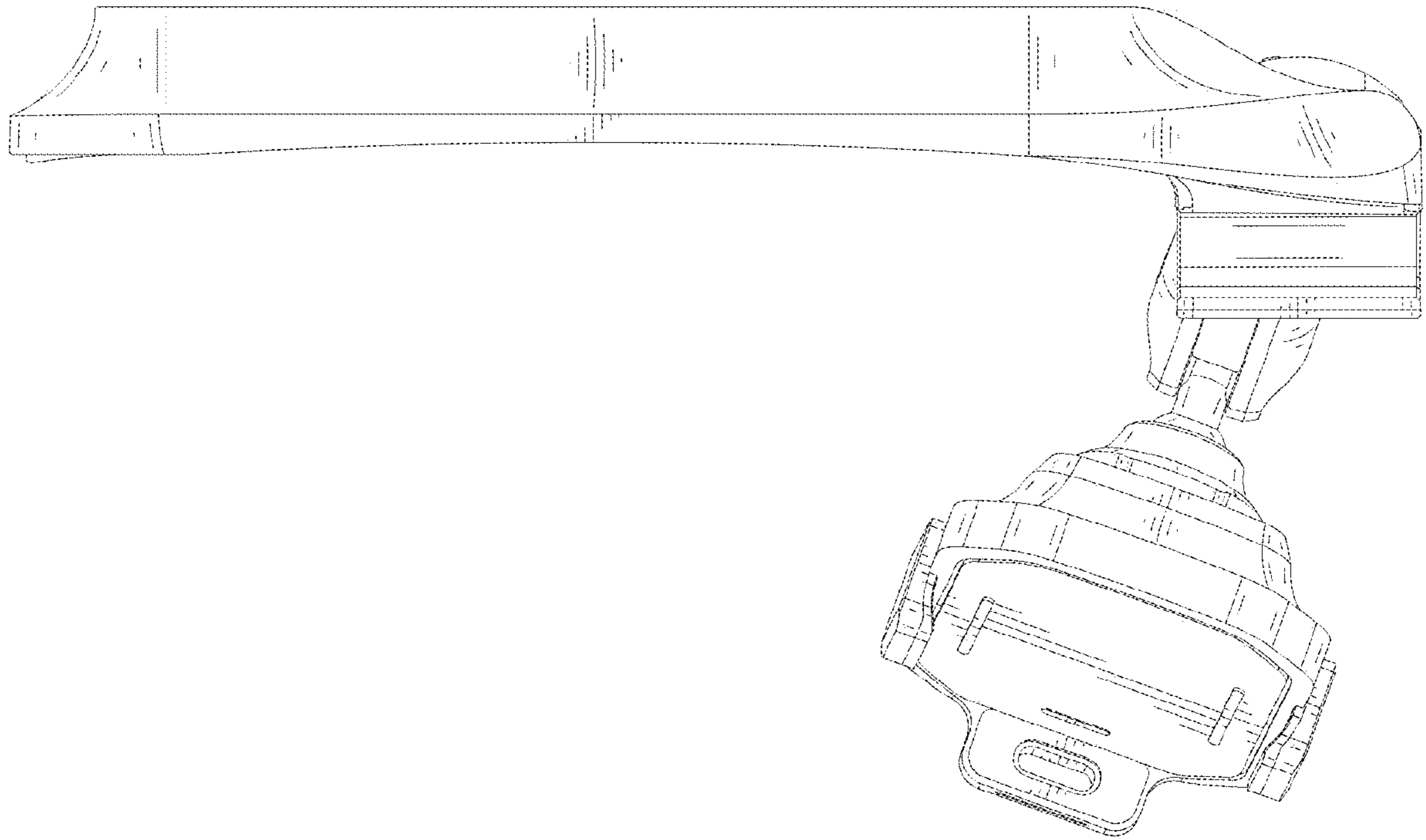

FIG. 7

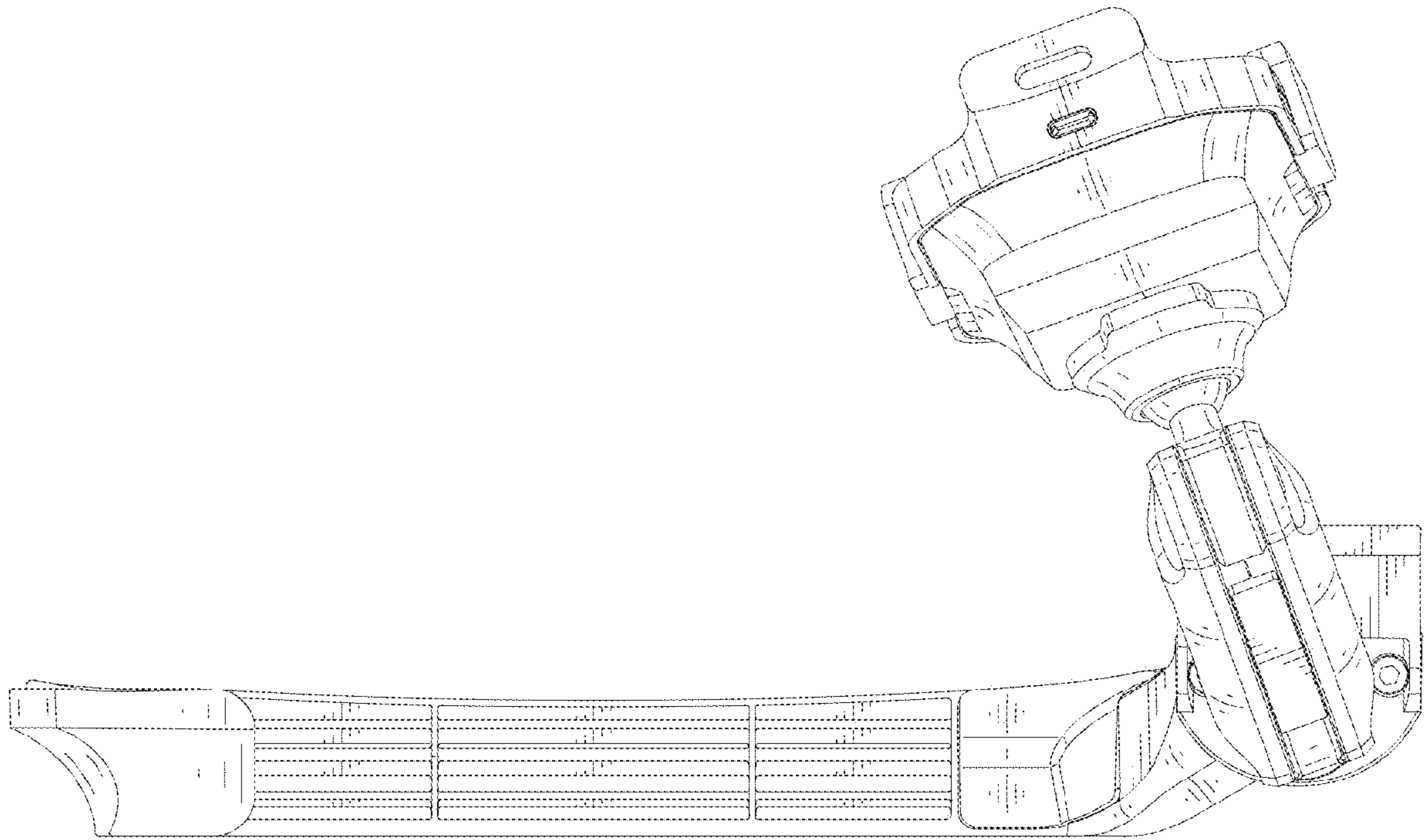

FIG. 8