



US00D915402S

(12) **United States Design Patent** (10) **Patent No.:** **US D915,402 S**
Gilbertson et al. (45) **Date of Patent:** **** Apr. 6, 2021**

(54) **ELECTRONIC KEY CONTROL UNIT**

(56) **References Cited**

(71) Applicant: **3-East, LLC**, Coatesville, PA (US)

U.S. PATENT DOCUMENTS

(72) Inventors: **Matthew R. Gilbertson**, Downingtown, PA (US); **Jeffrey Gilbertson**, Honey Brook, PA (US); **Timothy A. Freese**, Coatesville, PA (US)

D480,725 S *	10/2003	Funato	D14/383
D616,439 S	5/2010	Mugica	
D668,251 S *	10/2012	Morrell	D14/383
D673,952 S *	1/2013	Toda	D14/383
D712,407 S *	9/2014	Chang	D14/389
D716,815 S	11/2014	Van Hees	
D718,282 S *	11/2014	Bennett	D13/163
D720,393 S *	12/2014	Held	D18/4.4
D727,901 S *	4/2015	Nishimura	D14/383
D741,298 S *	10/2015	Lintz	D14/217
D770,451 S *	11/2016	Gilbertson	D14/383
D792,858 S *	7/2017	Tehranchi	D13/164
D812,616 S *	3/2018	Potash	D14/383
2008/0170049 A1 *	7/2008	Larson	G06F 3/03545 345/179

(73) Assignee: **3-East, LLC**, Coatesville, PA (US)

(**) Term: **15 Years**

(21) Appl. No.: **29/607,729**

(22) Filed: **Jun. 15, 2017**

* cited by examiner

Related U.S. Application Data

Primary Examiner — Austin Murphy

(63) Continuation of application No. 15/178,352, filed on Jun. 9, 2016, now Pat. No. 10,109,124.

(74) *Attorney, Agent, or Firm* — Bonini IP Law, LLC; Frank J. Bonini, Jr.

(51) **LOC (13) Cl.** **14-02**

(57) **CLAIM**

(52) **U.S. Cl.**

The ornamental design for an electronic key control unit, as shown and described.

USPC **D14/383**

DESCRIPTION

(58) **Field of Classification Search**

USPC D14/356–358, 383–385, 420, 426, 427, D14/432–439, 447, 453, 454, 217, 253, D14/299, 307; D13/107, 108, 133, 146, D13/147, 152, 154, 156, 158, 162, 162.1, D13/168, 173, 177, 102; 235/441, 451, 235/492, 380, 439, 375; 361/679.31, 600, 361/679.01, 679.02

FIG. 1 is a perspective view of an electronic key control unit according to our new design, as viewed from the front, above and to the left of the device;
FIG. 2 is a front elevation view thereof;
FIG. 3 is a rear elevation view thereof;
FIG. 4 is a right side elevation view thereof;
FIG. 5 is a left side elevation view thereof; and
FIG. 6 is a top plan view thereof.

CPC G07C 9/00103; G07C 9/00039; G07C 9/00904; G06K 5/00; G06K 7/01

The broken lines in FIGS. 1-6 are for illustrative purposes and form no part of the claimed invention.

See application file for complete search history.

1 Claim, 6 Drawing Sheets

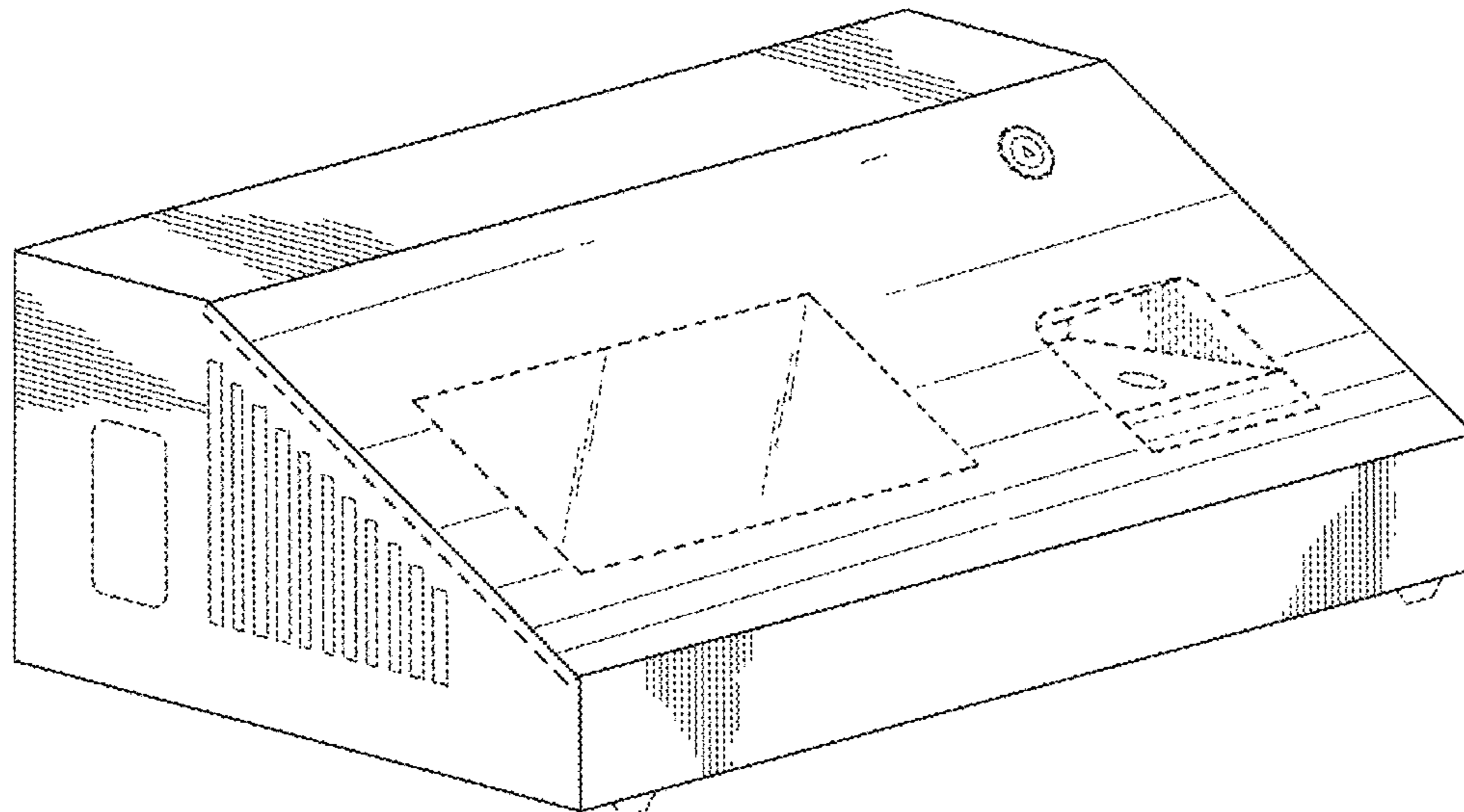

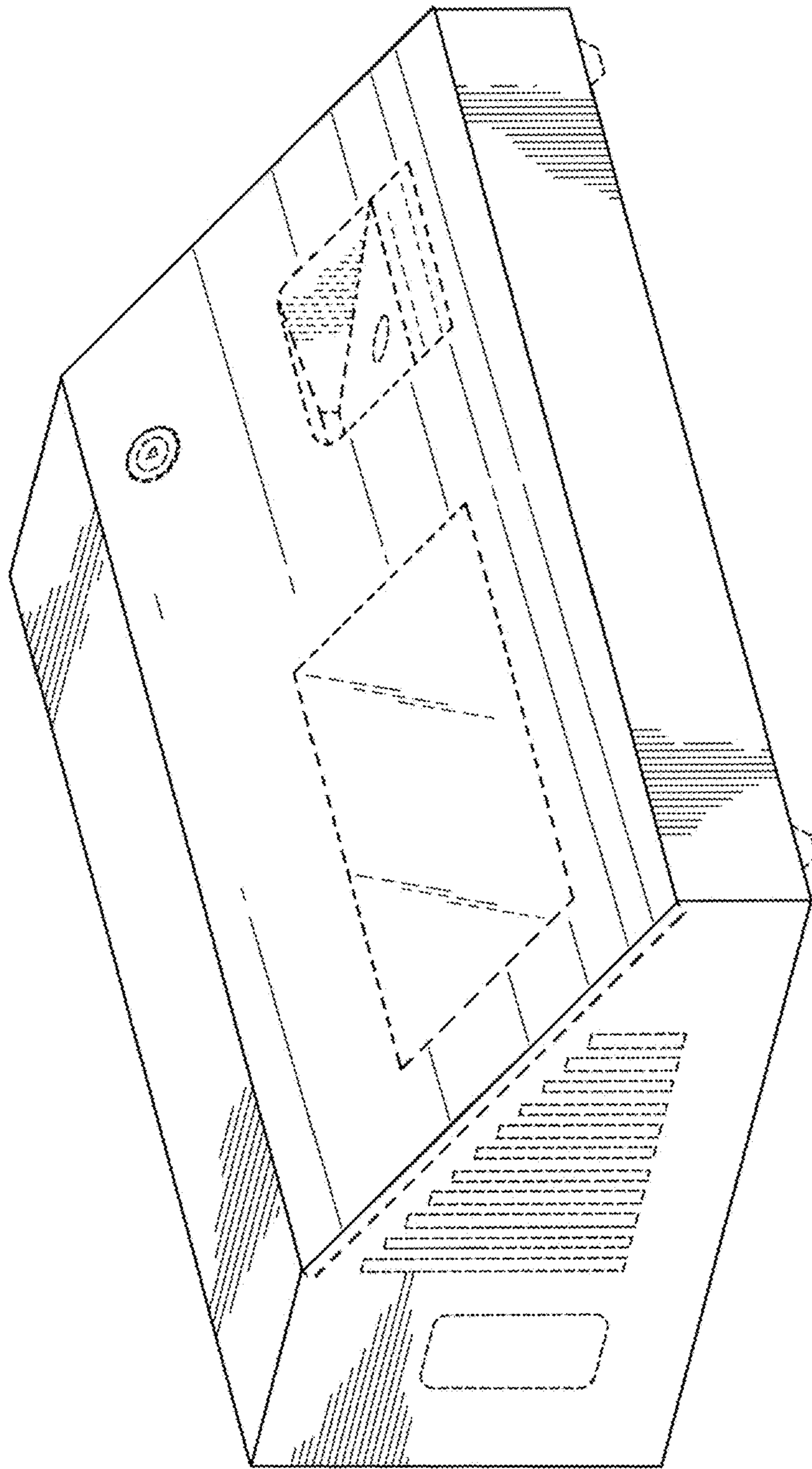

FIG. 1

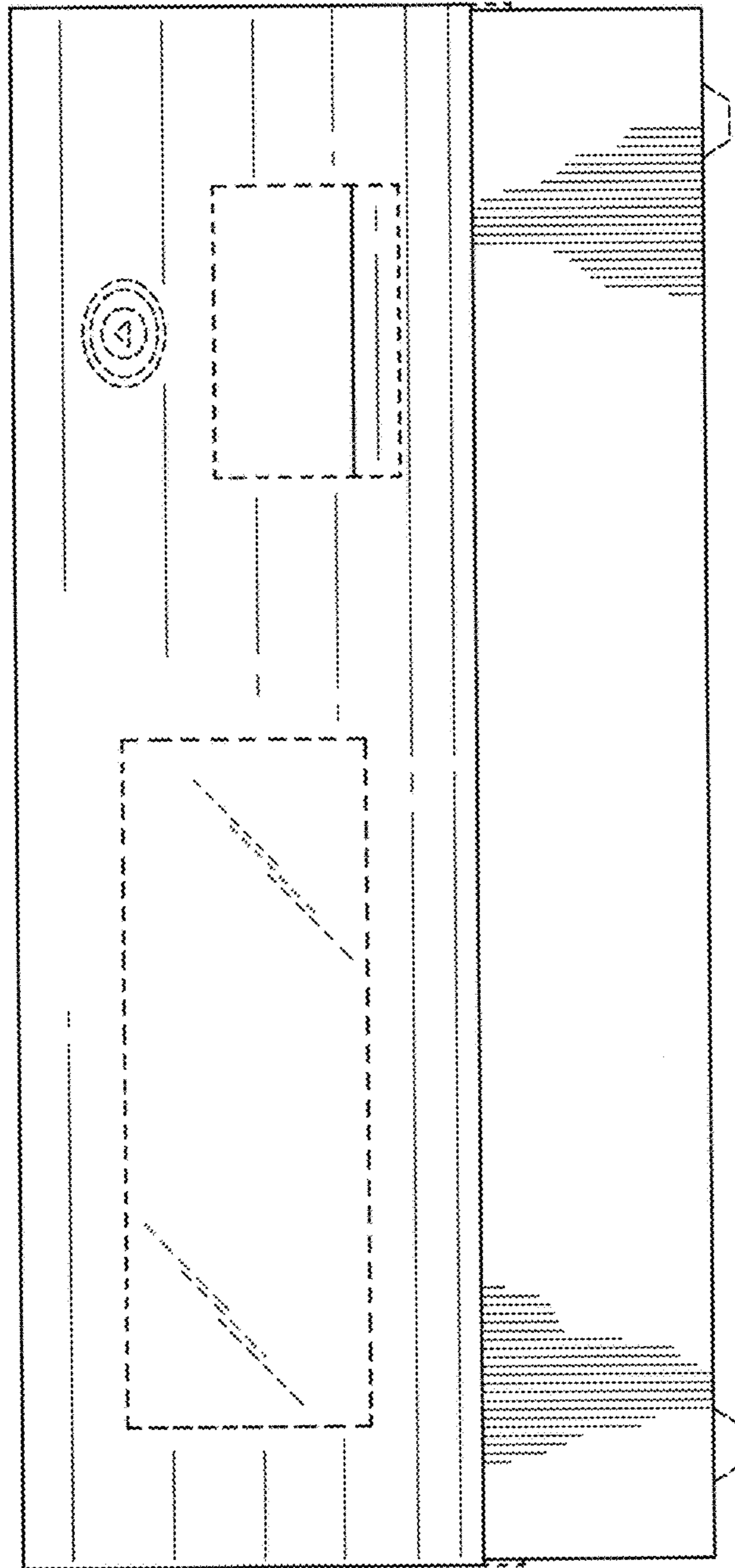

FIG. 2

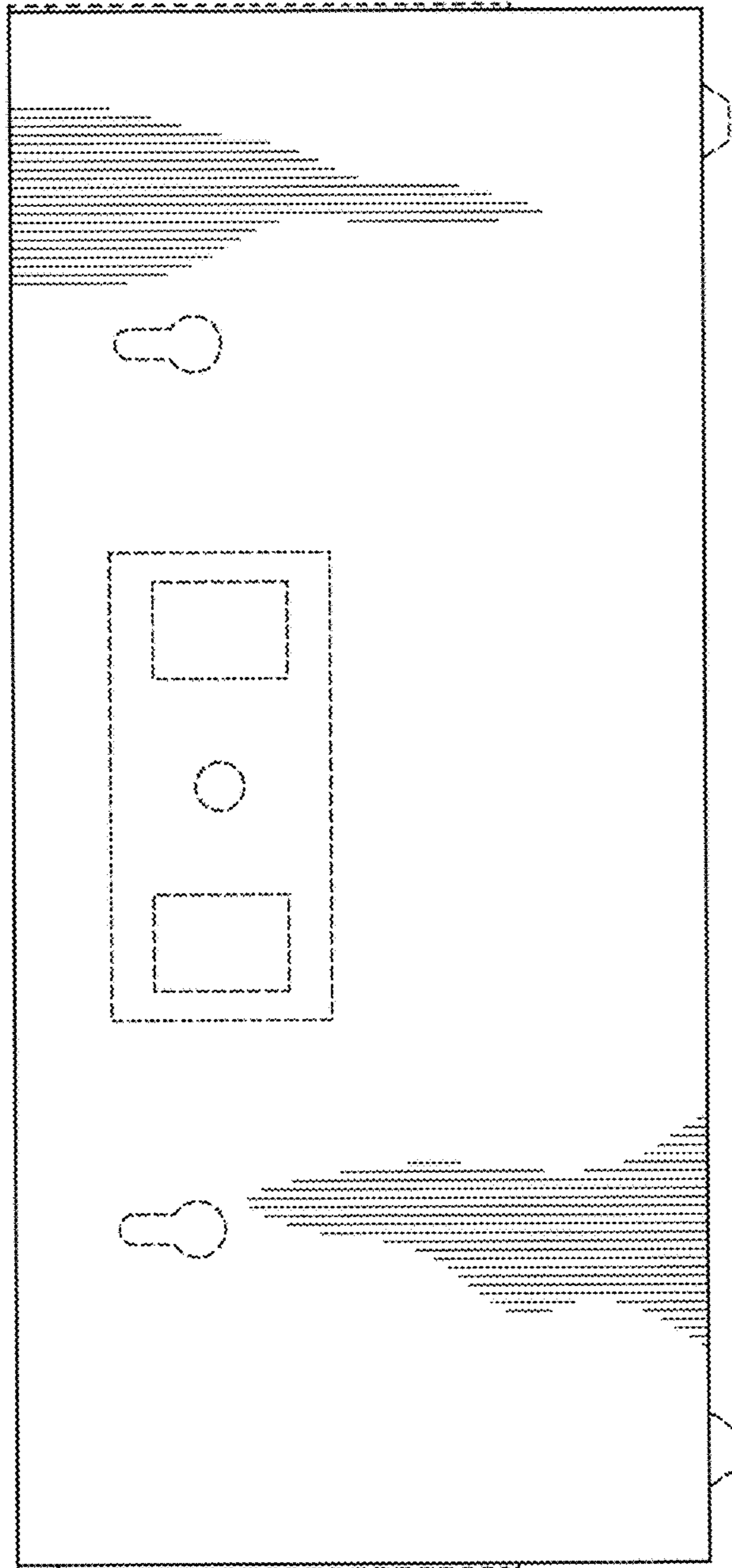

FIG. 3

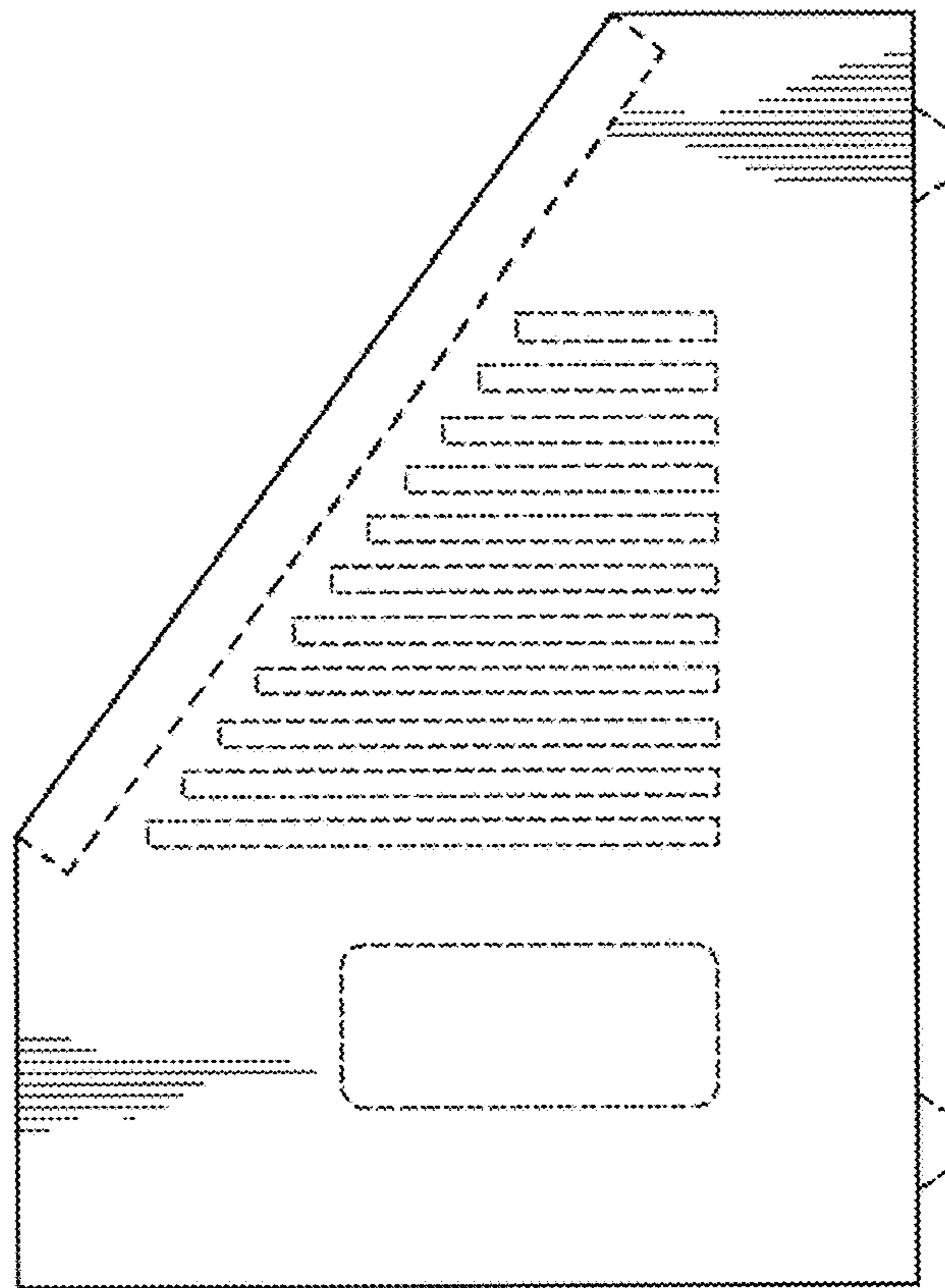

FIG. 4

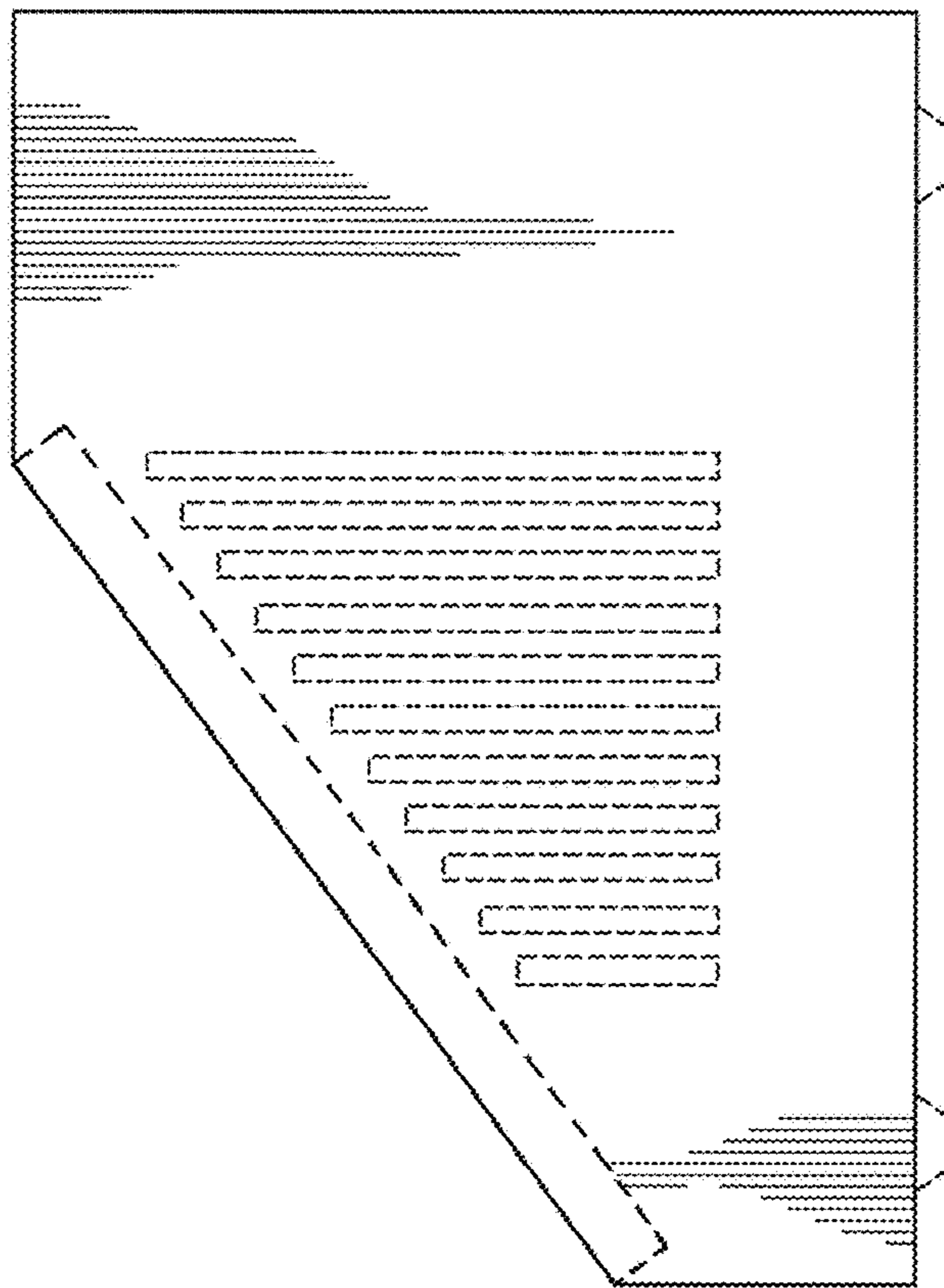

FIG. 5

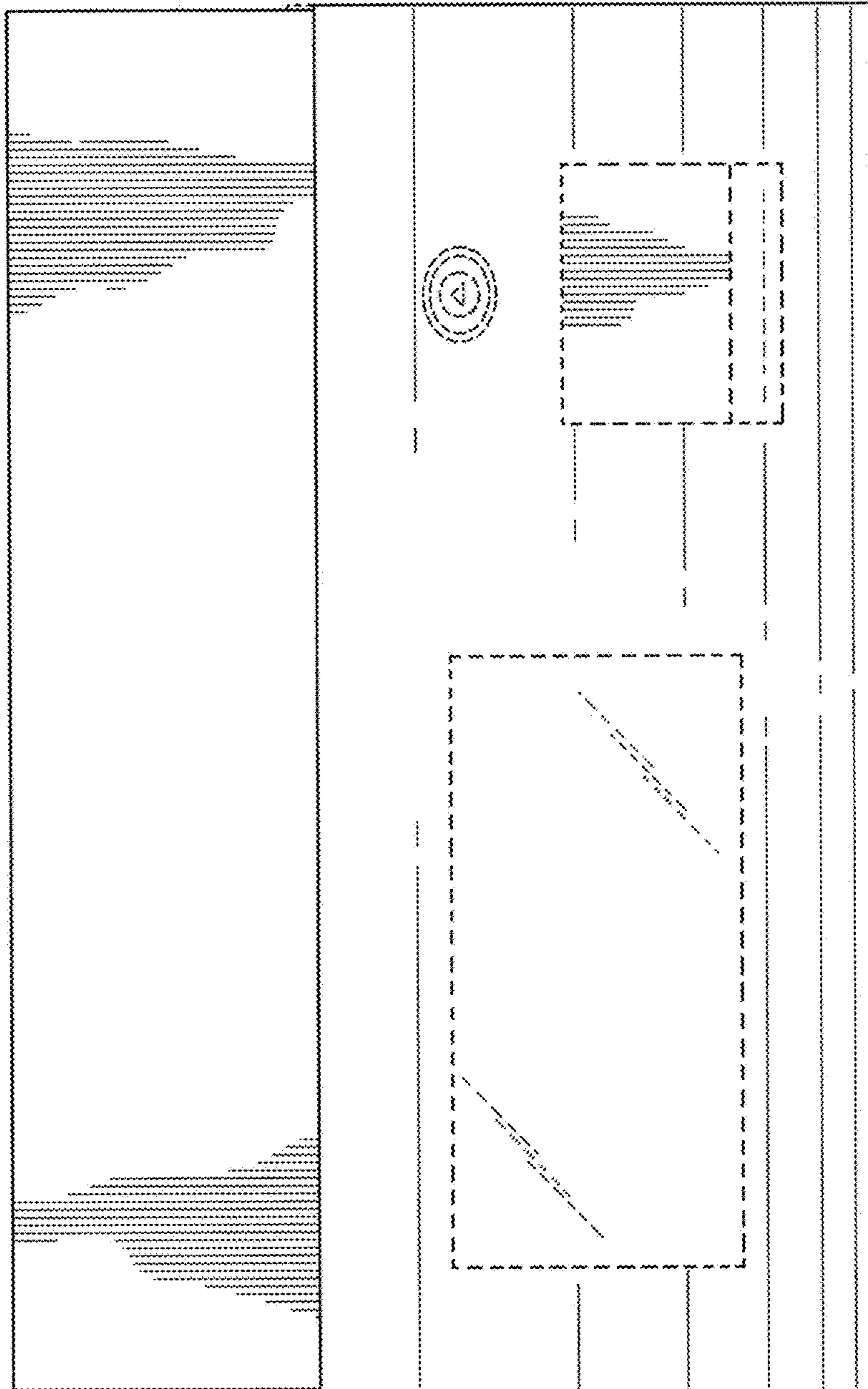

FIG. 6