



US00D915393S

(12) **United States Design Patent** (10) **Patent No.:** **US D915,393 S**
Lee et al. (45) **Date of Patent:** **** Apr. 6, 2021**

(54) **LAPTOP COMPUTER**

(71) Applicant: **LG ELECTRONICS INC.**, Seoul (KR)
(72) Inventors: **Taejin Lee**, Seoul (KR); **Daihyung Ryu**, Seoul (KR); **Gangho Woo**, Seoul (KR)
(73) Assignee: **LG ELECTRONICS INC.**, Seoul (KR)
(**) Term: **15 Years**

(21) Appl. No.: **35/507,097**

(22) Filed: **Jan. 16, 2019**

(80) **Hague Agreement Data**

Int. Filing Date: **Jan. 16, 2019**
Int. Reg. No.: **DM/201054**
Int. Reg. Date: **Jan. 16, 2019**
Int. Reg. Pub. Date: **Jul. 19, 2019**

(30) **Foreign Application Priority Data**

Jul. 20, 2018 (KR) 30-2018-0033625

(51) **LOC (13) Cl.** **14-02**

(52) **U.S. Cl.**
USPC **D14/316**; D14/318; D14/322

(58) **Field of Classification Search**
USPC D14/203.4, 316, 317, 319-327, 341, 345, D14/346, 501, 502, 507; D21/330
(Continued)

(56) **References Cited**

U.S. PATENT DOCUMENTS

D506,752 S * 6/2005 Huh D14/316
D593,091 S * 5/2009 Behar D14/371
(Continued)

OTHER PUBLICATIONS

LG Gram 14 2-in-1 review, publication date Apr. 4, 2020, [online][site visited Apr. 8, 2020] URL: <https://www.cnet.com/reviews/lg-gram-14-2-in-1-review/> (Year: 2020).*

(Continued)

Primary Examiner — L. A. Grabenstetter
(74) *Attorney, Agent, or Firm* — Birch, Stewart, Kolasch & Birch, LLP

(57) **CLAIM**

The ornamental design for a laptop computer, as shown and described.

DESCRIPTION

- 1. Laptop computer
- 1.1 : Perspective View, shown in closed configuration
- 1.2 : Front View thereof
- 1.3 : Back View thereof
- 1.4 : Left View thereof
- 1.5 : Right View thereof
- 1.6 : Top View thereof
- 1.7 : Bottom View thereof
- 1.9 : Perspective View, shown in open configuration
- 1.10 : Front View thereof
- 1.11 : Back View thereof
- 1.12 : Left View thereof
- 1.13 : Right View thereof
- 1.14 : Top View thereof
- 1.15 : Bottom View thereof
- 1.17 : Perspective View, shown in fully pivoted configuration
- 1.18 : Front View thereof
- 1.19 : Back View thereof
- 1.20 : Left View thereof
- 1.21 : Right View thereof
- 1.22 : Top View thereof
- 1.23 : Bottom View thereof

The broken lines indicate portions of the article that form no part of the claimed design.

1 Claim, 21 Drawing Sheets

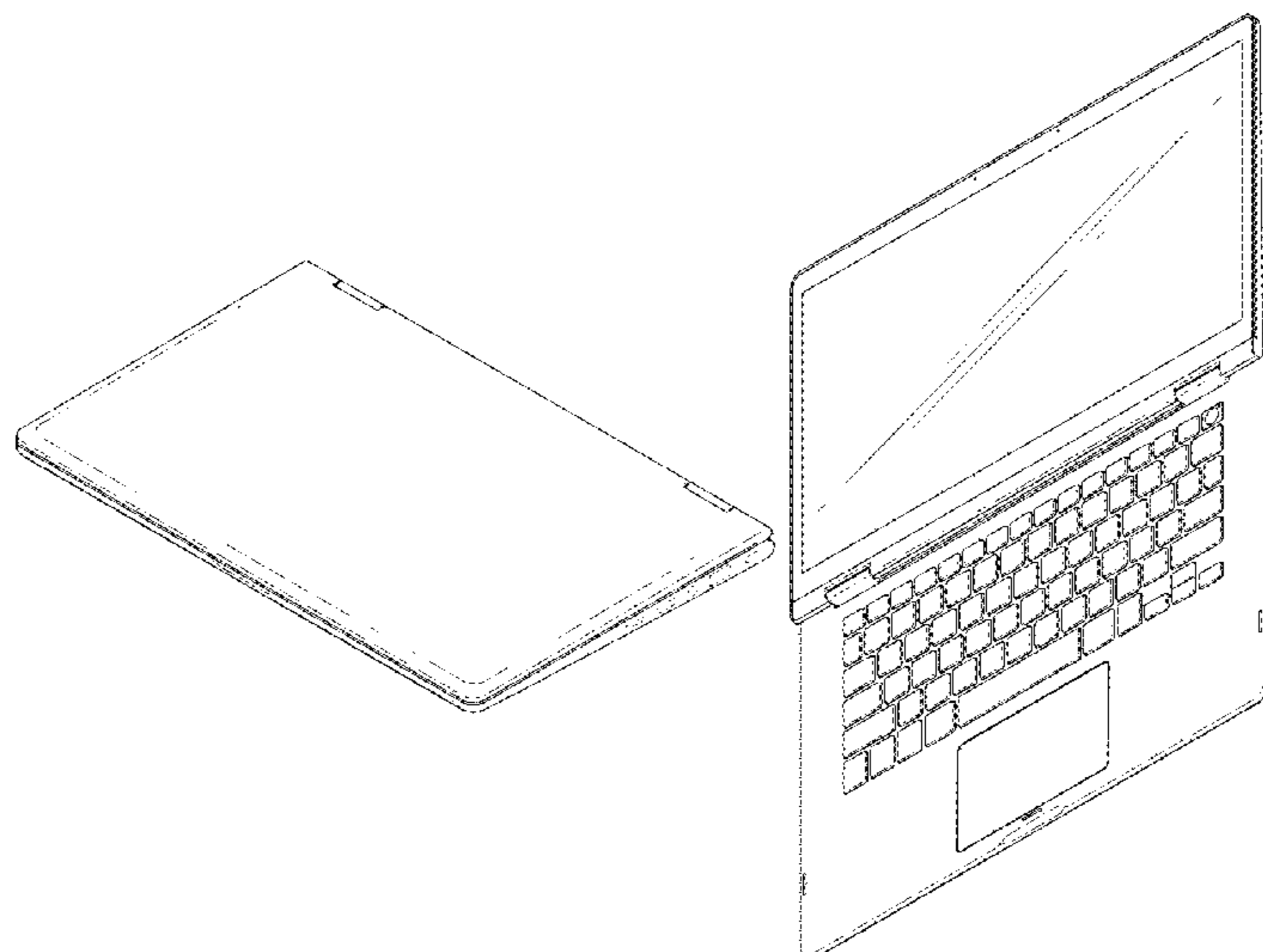

1.1

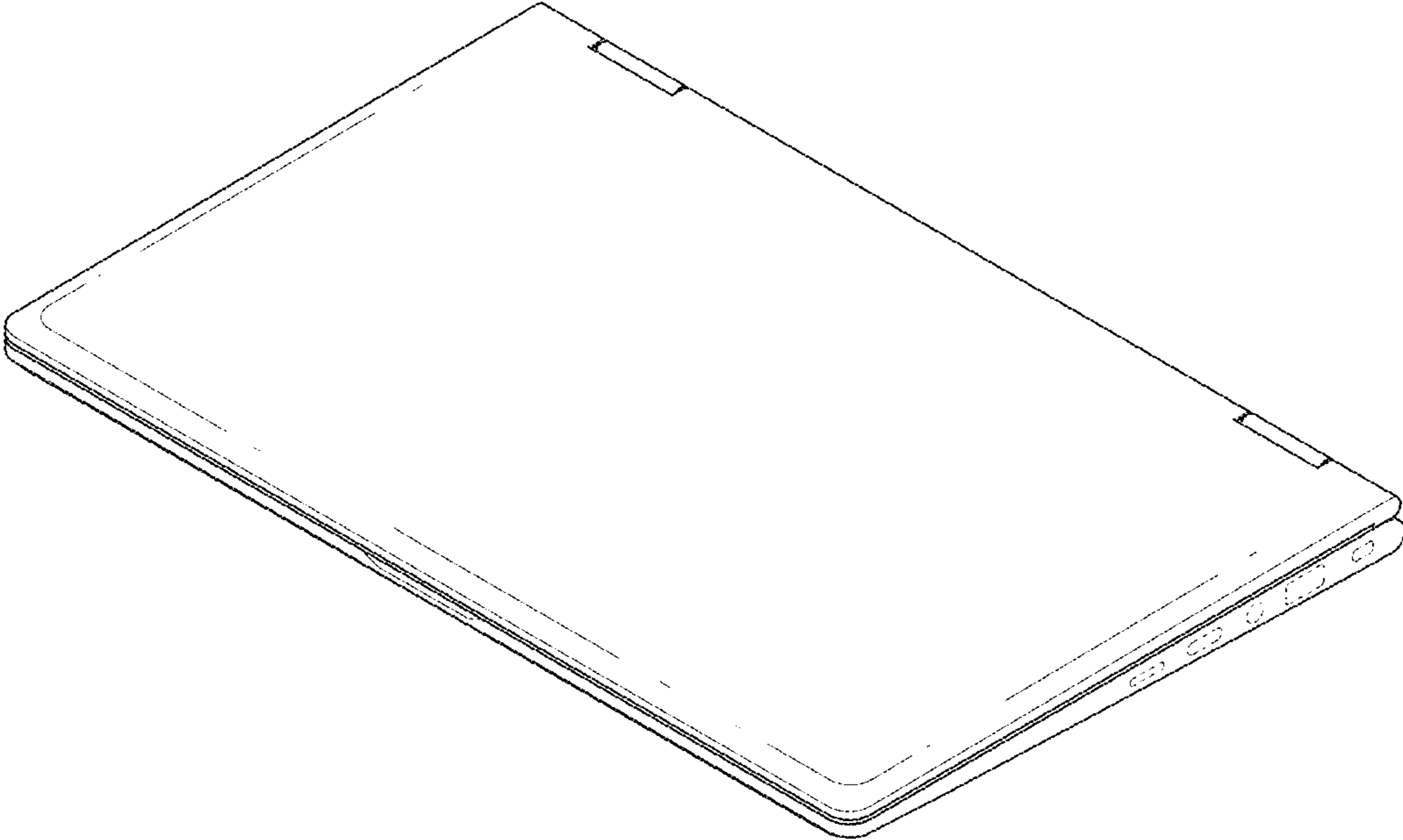

1.2

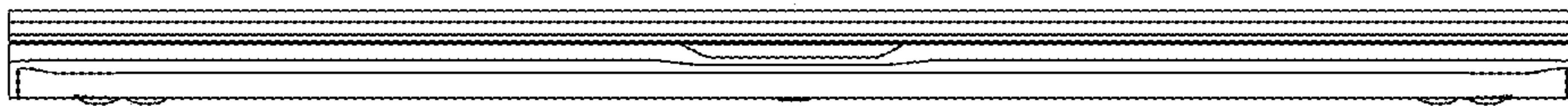

1.3

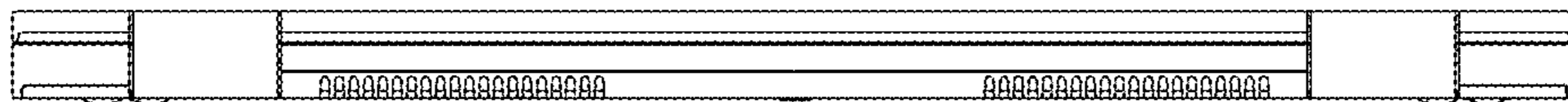

1.4

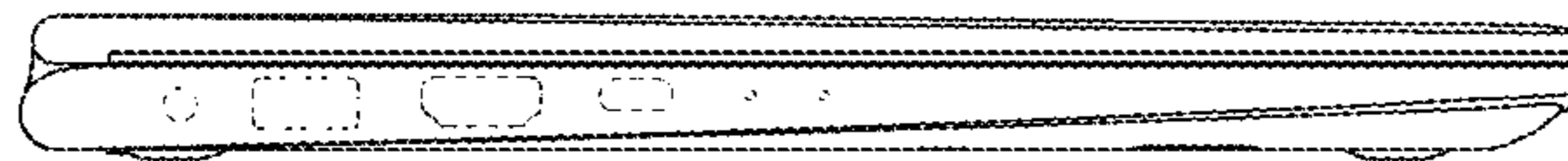

1.5

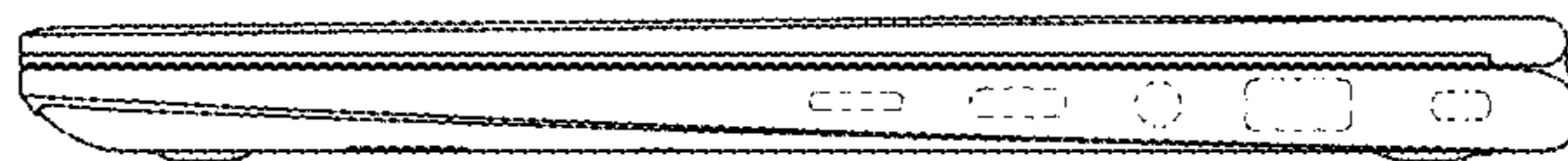

1.6

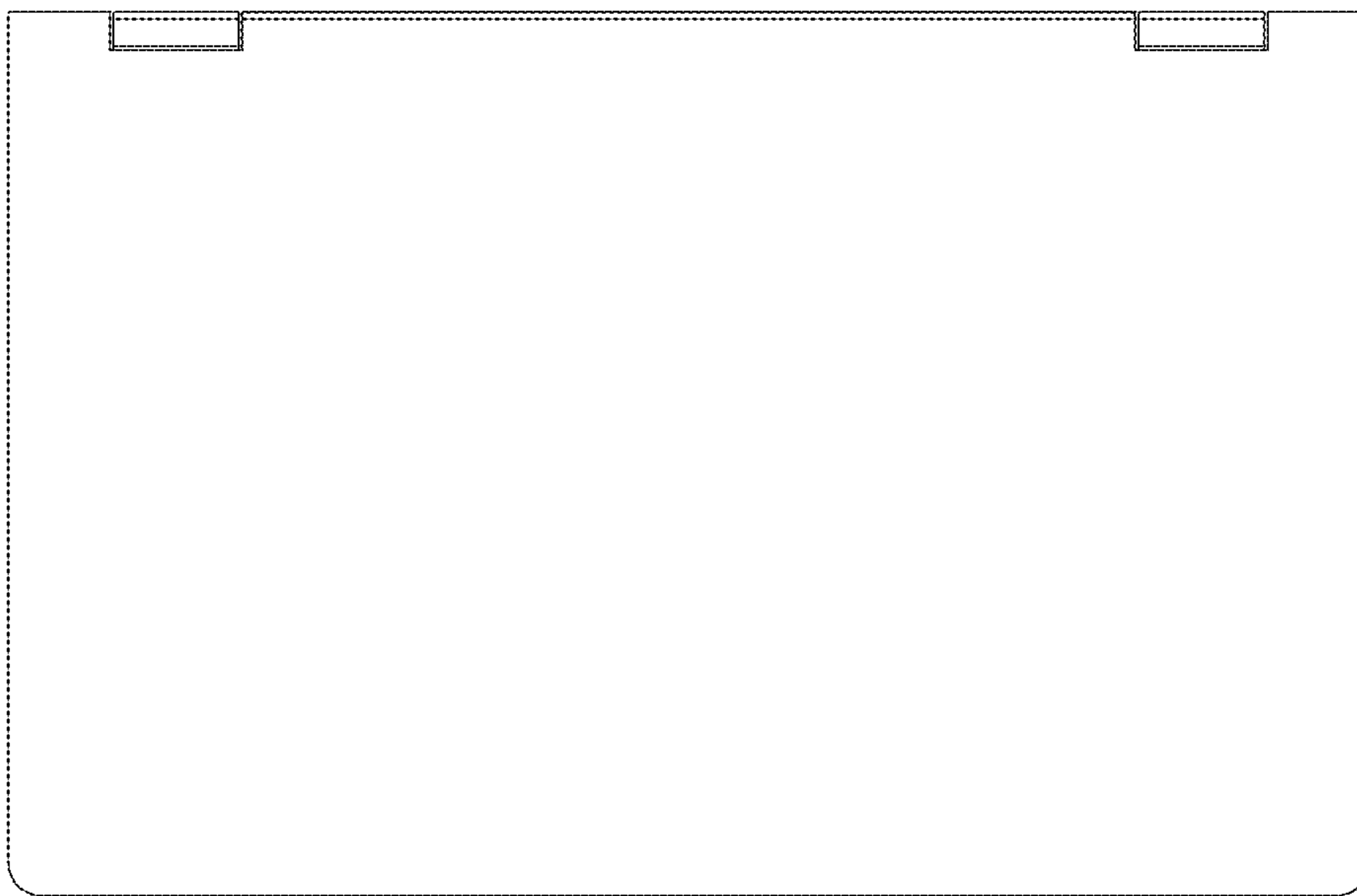

1.7

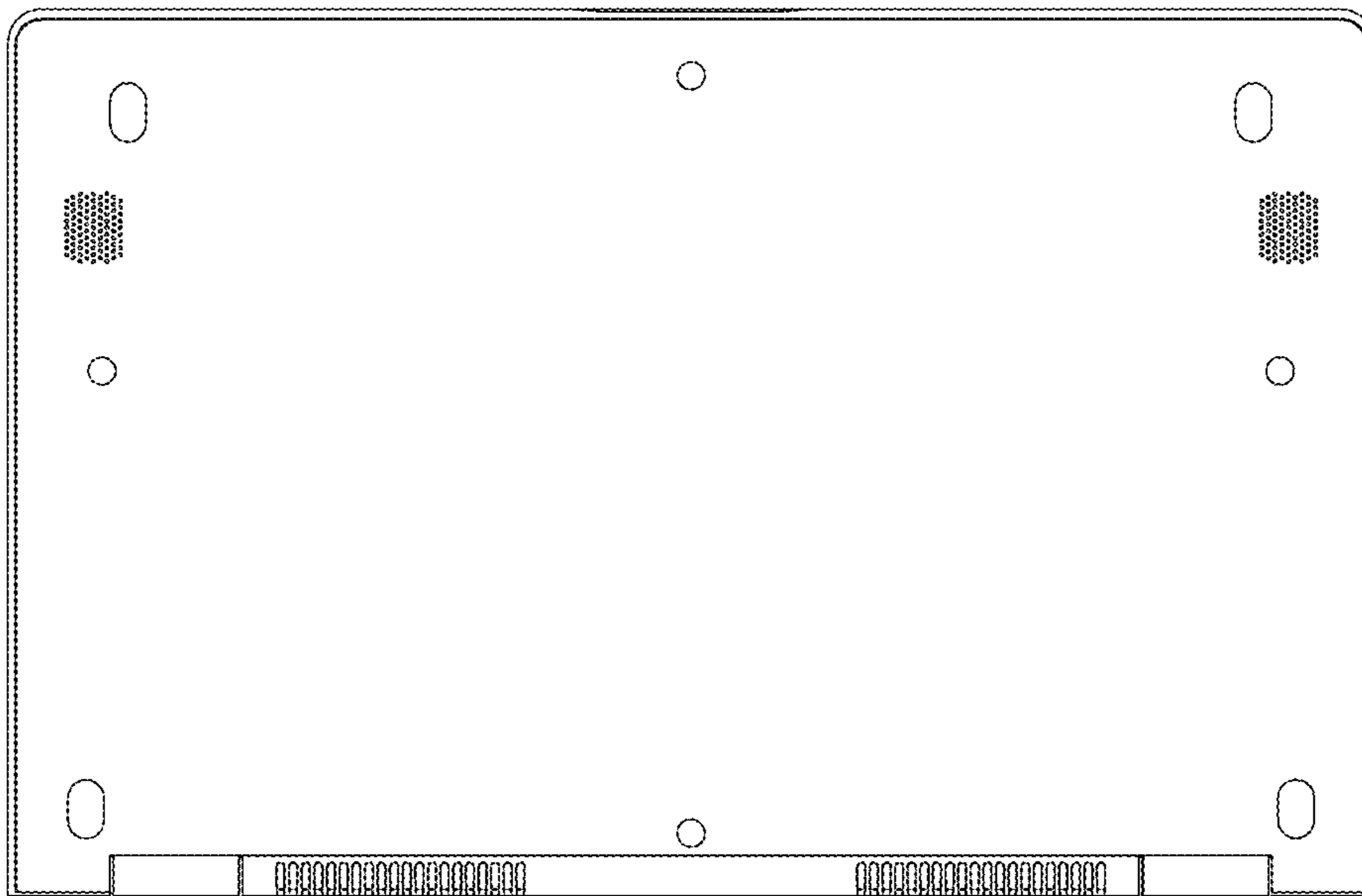

1.9

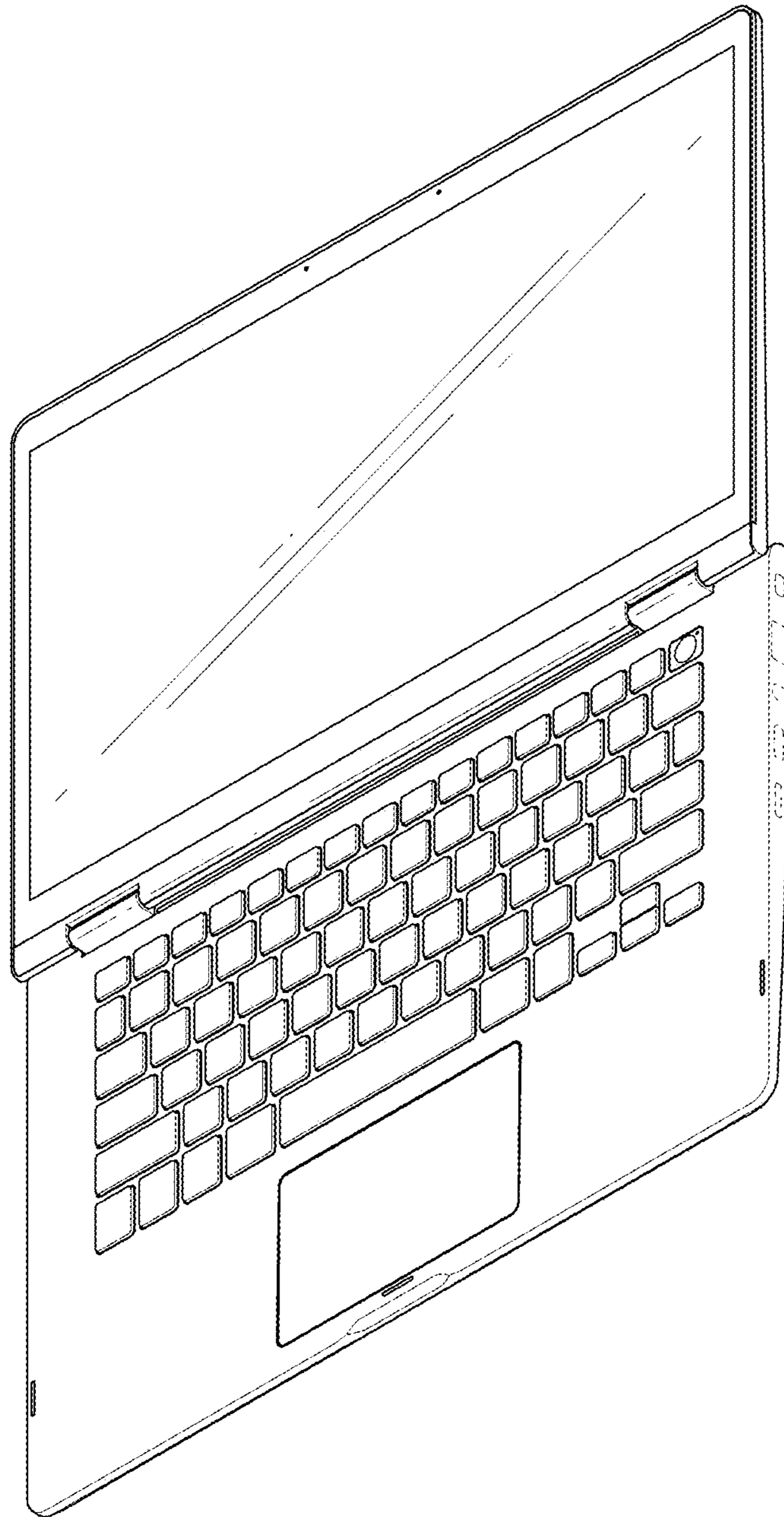

1.10

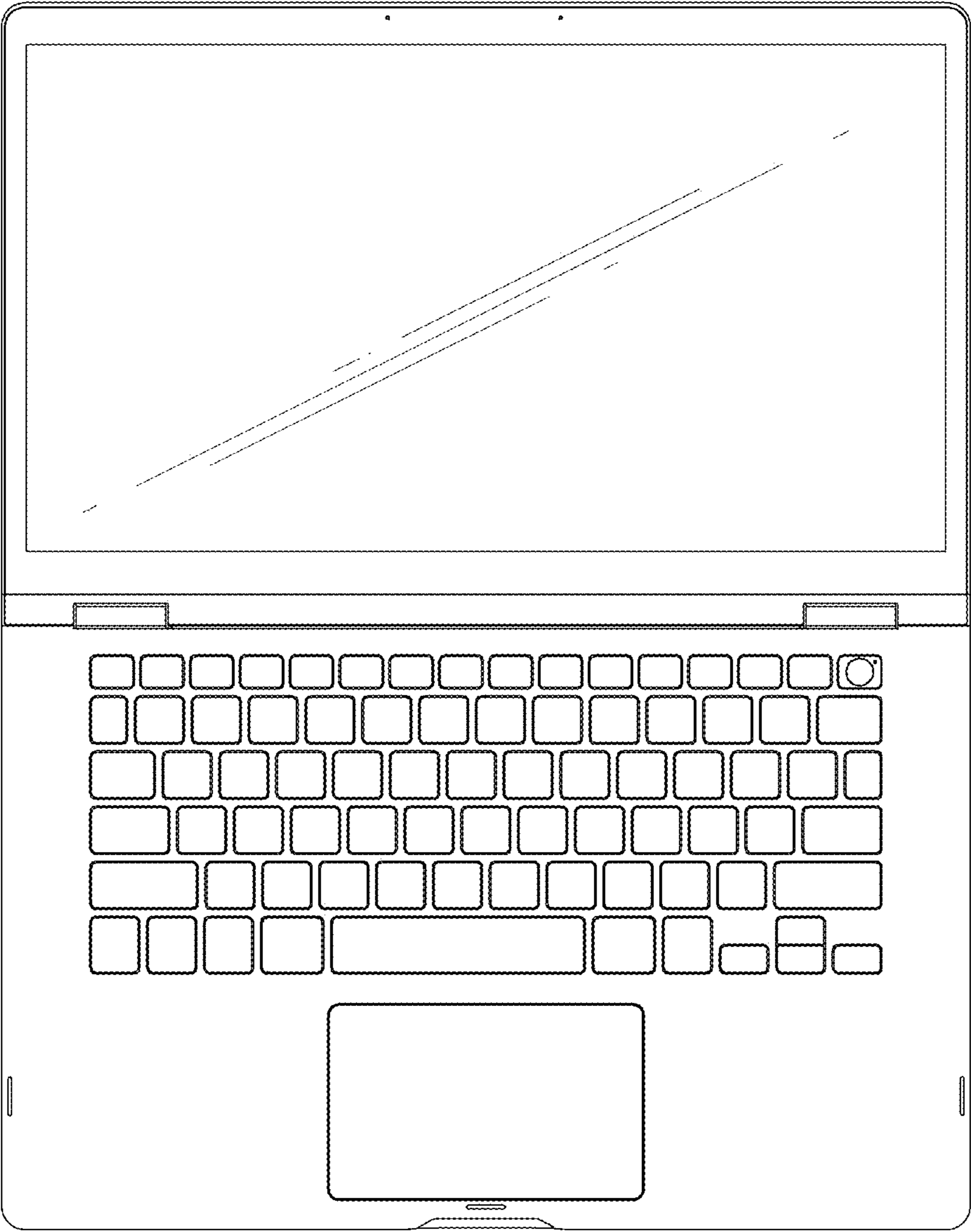

1.11

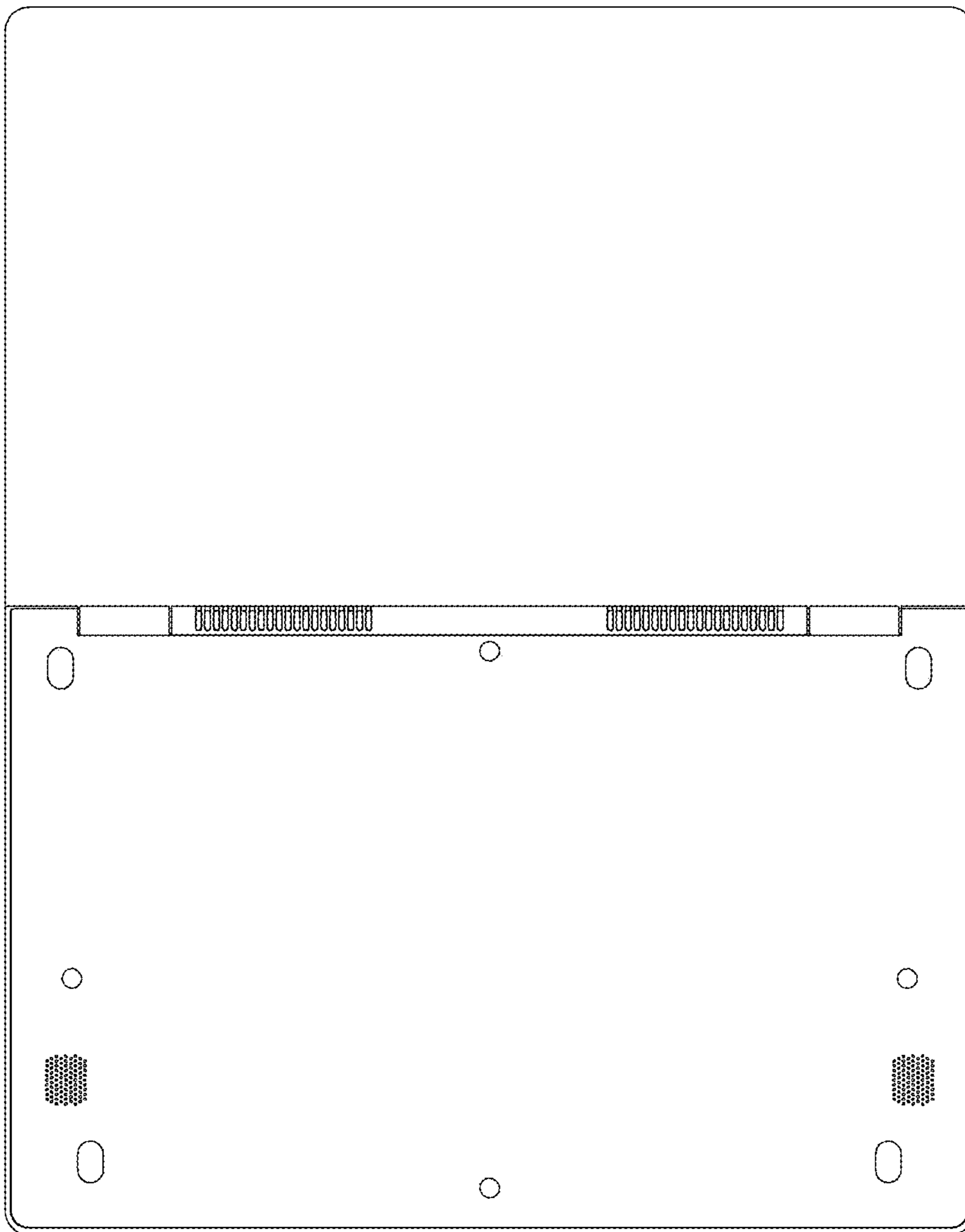

1.12

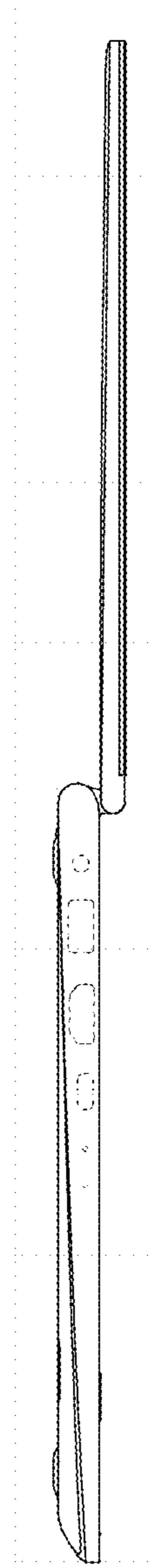

1.13

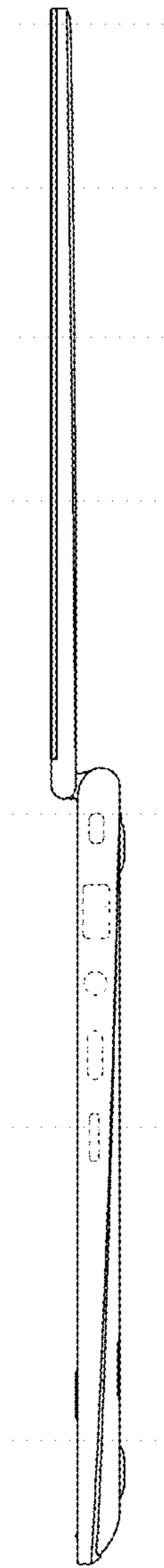

1.14

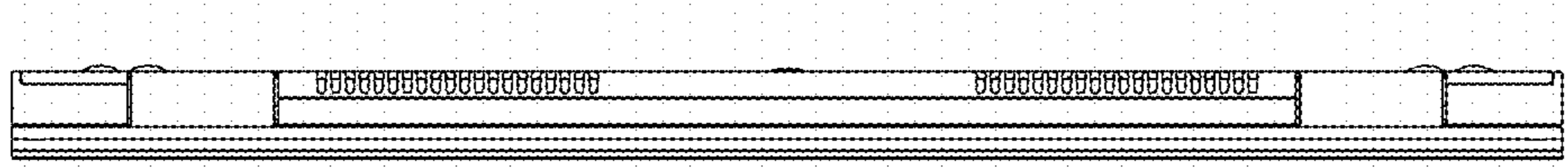

1.15

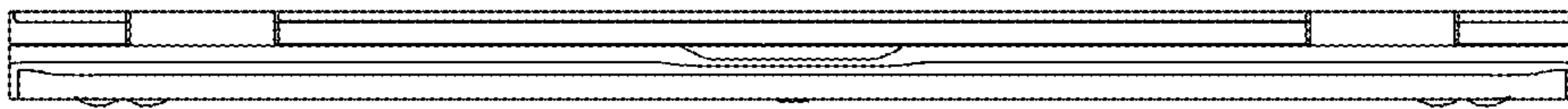

1.17

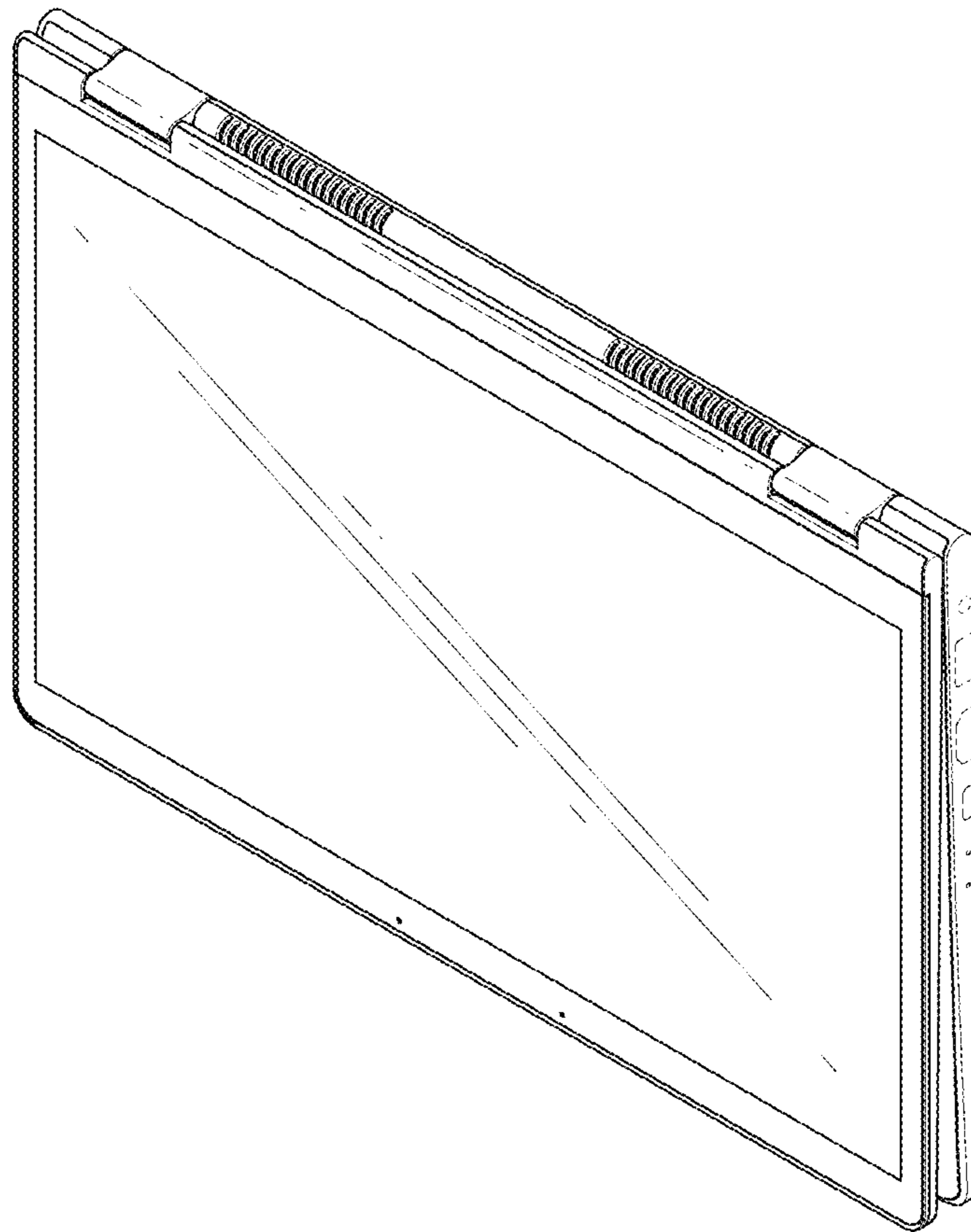

1.18

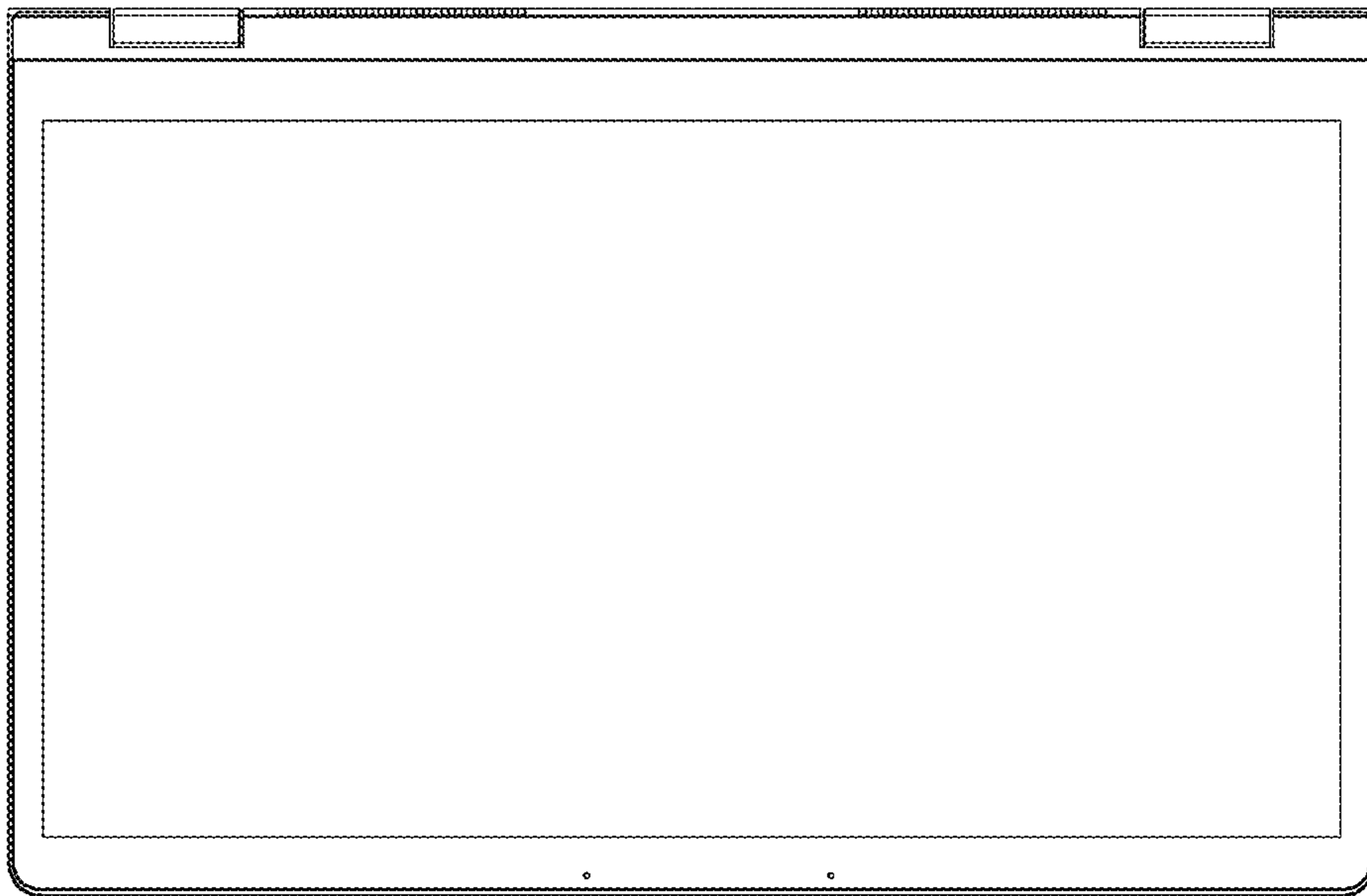

1.19

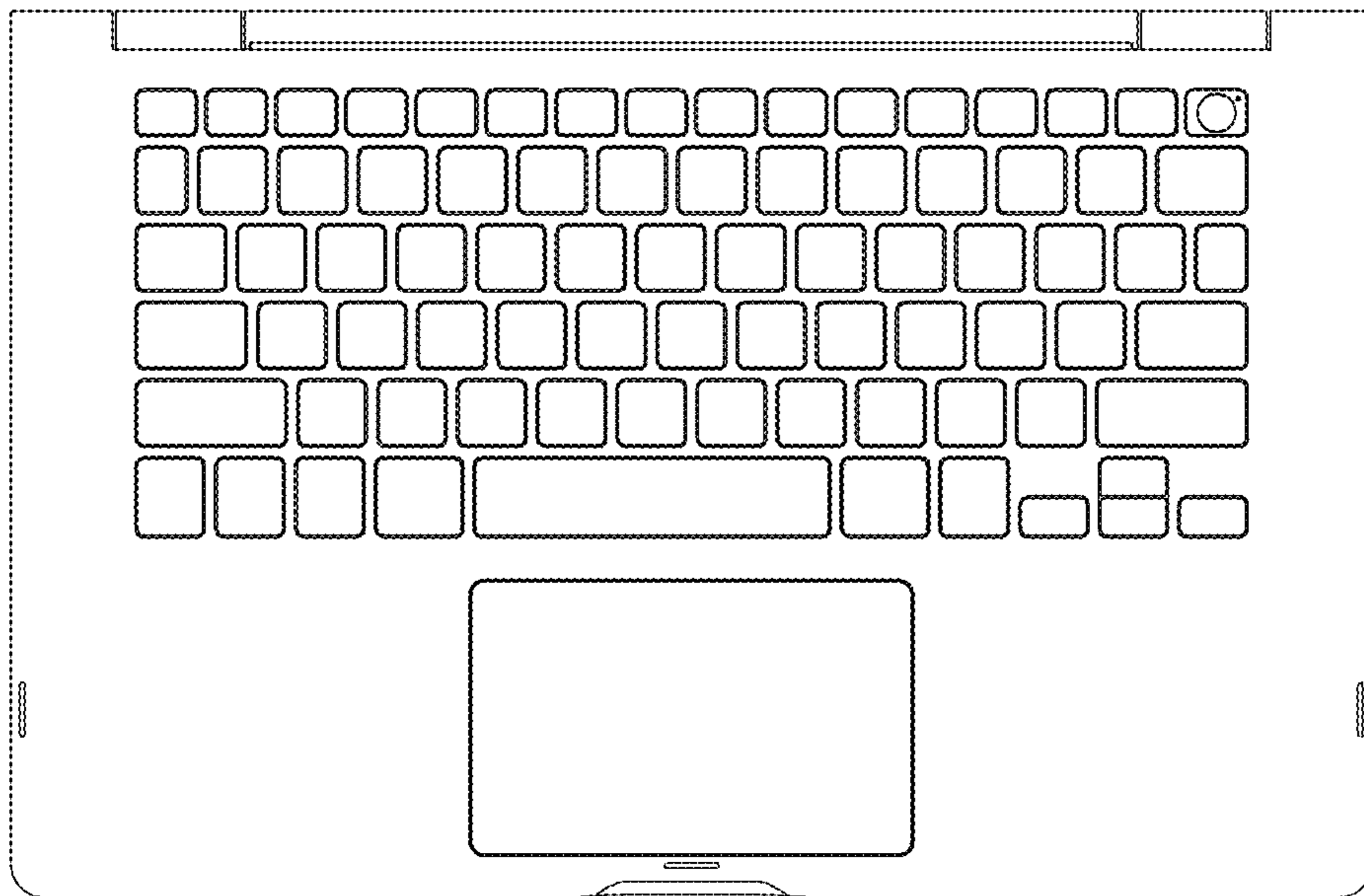

1.20

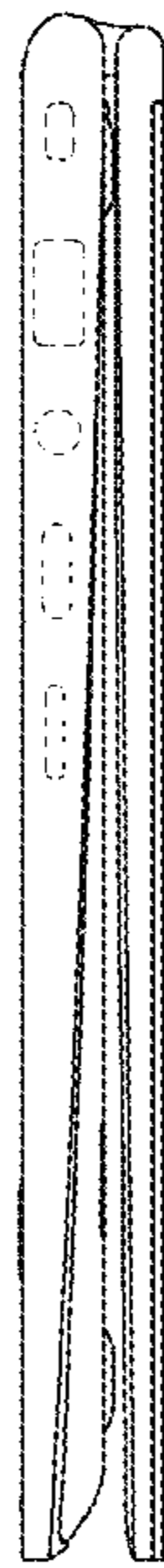

1.21



1.22



1.23

