



US00D915385S

(12) **United States Design Patent** (10) **Patent No.:** **US D915,385 S**  
**Lee** (45) **Date of Patent:** **\*\* Apr. 6, 2021**

(54) **CASE FOR ELECTRONIC COMMUNICATIONS DEVICE**

(71) Applicant: **SPIGEN KOREA CO., LTD.**, Seoul (KR)

(72) Inventor: **Jong Hwa Lee**, Seoul (KR)

(73) Assignee: **SPIGEN KOREA CO., LTD.**, Seoul (KR)

(\*\*) Term: **15 Years**

(21) Appl. No.: **29/728,825**

(22) Filed: **Mar. 20, 2020**

**Related U.S. Application Data**

(63) Continuation of application No. 29/681,774, filed on Feb. 27, 2019, now Pat. No. Des. 879,764.

(51) **LOC (13) Cl.** ..... **14-03**

(52) **U.S. Cl.**  
USPC ..... **D14/250**

(58) **Field of Classification Search**  
USPC ..... D3/201, 212, 218, 226, 227, 247, 249, D3/250, 269, 303; D13/103, 107, 108, D13/119; D14/137, 138 R, 138 AA, D14/138 C, 138 G, 172, 192, D14/203.3–203.7, 217, 238.1, 247, 248, D14/250–253, 434, 440, 447, 496  
CPC ..... H04B 1/3888; H04M 1/0283; H04M 1/0202; A45C 1/06; A45C 2011/002; A45C 11/00; A45F 2005/028; A45F 2200/0525  
See application file for complete search history.

(56) **References Cited**

**U.S. PATENT DOCUMENTS**

D412,786 S \* 8/1999 Killinger ..... D3/273  
D414,033 S \* 9/1999 Rohm ..... D3/201

(Continued)

**OTHER PUBLICATIONS**

“Spigen Ultra Hybrid [2nd Generation] iPhone 7 Case/iPhone 8 Case with Air Cushion Technology for Apple iPhone 7 (2016)/iPhone 8 (2017)—Crystal Clear”, <http://www.amazon.com/dp/B01M0USRWG>, Earliest review date of Jan. 17, 2017, Downloaded on Jan. 8, 2019.\*

(Continued)

*Primary Examiner* — L. A. Grabenstetter

(74) *Attorney, Agent, or Firm* — Heedong Chae; Lucem, PC

(57) **CLAIM**

The ornamental design for a case for electronic communications device, as shown and described.

**DESCRIPTION**

FIG. 1 is a front perspective view of a case for electronic communications device in an open position showing my new design;

FIG. 2 is a rear perspective view thereof;

FIG. 3 is a front elevational view thereof;

FIG. 4 is a rear elevational view thereof;

FIG. 5 is a left side elevational view thereof;

FIG. 6 is a right side elevational view thereof;

FIG. 7 is a top plan view thereof;

FIG. 8 is a bottom plan view thereof;

FIG. 9 is a front perspective view thereof in a closed position, shown in an environment of use;

FIG. 10 is a rear perspective view thereof in a closed position, shown in an environment of use;

FIG. 11 is a front perspective view thereof in an open position, shown in an environment of use; and,

FIG. 12 is a rear perspective view thereof in an open position, shown in an environment of use.

The broken lines depict environmental subject matter and portions of the case for electronic communications device that form no part of the claimed design.

**1 Claim, 12 Drawing Sheets**

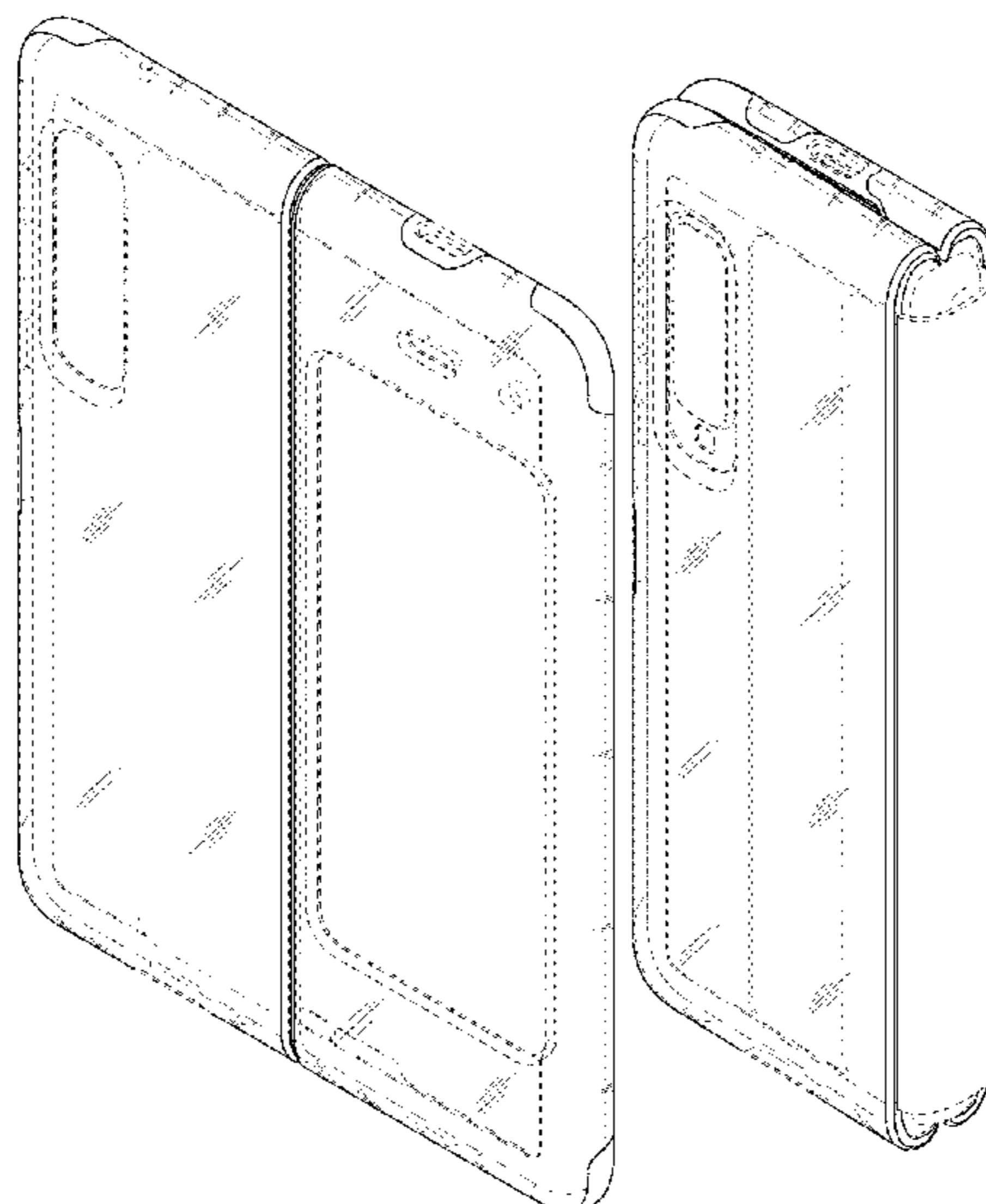

(56)

## References Cited

## U.S. PATENT DOCUMENTS

D423,772 S *	5/2000	Cooper	D3/201	9,077,436 B1	7/2015	Liu	
6,223,393 B1 *	5/2001	Knopf	G06F 1/1618	D739,394 S *	9/2015	Rayner	D14/25
			16/366	D741,845 S *	10/2015	Kim	D14/25
6,758,335 B2 *	7/2004	Kajiya	A45C 13/02	D744,472 S *	12/2015	Lerenthal	D14/25
			206/32	D744,491 S	12/2015	Lee	
D517,545 S *	3/2006	Buckel	D14/34	D745,013 S	12/2015	Brierley	
D524,806 S *	7/2006	Eguchi	D14/24	D746,805 S *	1/2016	Kim	D14/25
D527,182 S *	8/2006	Ham	D3/274	D747,708 S *	1/2016	Roberts	D14/25
D551,846 S *	10/2007	Ko	D3/201	D749,535 S *	2/2016	Joung	D14/13
D559,843 S *	1/2008	Takamori	D14/24	D749,557 S *	2/2016	Feng	D14/25
D560,216 S *	1/2008	Takamori	D14/24	D749,594 S *	2/2016	Kim	D14/44
D574,819 S *	8/2008	Andre	D3/269	9,293,808 B1 *	3/2016	Roberts	H01Q 1/2266
7,451,872 B1 *	11/2008	Allen	A45C 13/103	D754,643 S	4/2016	Shin	
			190/117	D754,652 S *	4/2016	Roberts	D14/25
D582,659 S *	12/2008	Katsof	D3/201	D755,168 S	5/2016	Kim	
D592,399 S *	5/2009	Sage	D3/295	D755,766 S	5/2016	Kim	
D601,992 S *	10/2009	Choi	D14/138 AB	D755,770 S	5/2016	Kim	
D615,077 S *	5/2010	Richardson	D14/25	D756,341 S *	5/2016	Kim	D14/25
D615,536 S *	5/2010	Richardson	D14/25	D756,342 S *	5/2016	Lee	D14/25
D619,361 S *	7/2010	Andre	D3/269	D756,343 S *	5/2016	Wall	D14/25
D621,396 S *	8/2010	Lee	D14/252	D756,345 S *	5/2016	Roberts	D14/25
D623,639 S *	9/2010	Richardson	D14/25	D756,909 S *	5/2016	Gupta	D13/10
D623,640 S *	9/2010	Freeman	D14/25	D756,910 S *	5/2016	Gupta	D13/10
D624,304 S *	9/2010	Danze	D3/201	D756,911 S *	5/2016	Gupta	D13/10
D624,515 S *	9/2010	Kim	D14/138 AB	D763,239 S *	8/2016	Chan	D14/25
D631,455 S *	1/2011	Kim	D14/138 AB	D763,241 S *	8/2016	Kim	D14/25
D643,029 S *	8/2011	Feng	D14/25	D765,627 S *	9/2016	Watt	D14/25
D643,837 S *	8/2011	Smith	D14/25	D765,633 S *	9/2016	Northrup	D14/25
D647,892 S *	11/2011	Ragde, Jr.	D14/238.1	D765,643 S *	9/2016	Witter	D14/25
D651,202 S *	12/2011	Fathollahi	D14/25	D765,645 S *	9/2016	Kim	D14/25
D656,495 S *	3/2012	Andre	D14/25	D771,027 S *	11/2016	Prstojevich	D14/25
D657,354 S *	4/2012	Kim	D14/25	D771,612 S *	11/2016	Roberts	D14/25
D662,924 S *	7/2012	Melanson	D14/25	D771,613 S *	11/2016	Poon	D14/25
D662,929 S *	7/2012	Fahrendorff	D14/25	D772,854 S *	11/2016	Igarashi	D14/25
D663,263 S *	7/2012	Gupta	D13/10	D772,881 S *	11/2016	Chang	D14/44
D671,930 S *	12/2012	Akana	D14/25	D773,445 S *	12/2016	Witter	D14/25
D673,539 S *	1/2013	Magness	D14/25	D776,104 S *	1/2017	Tien	D14/25
D674,789 S *	1/2013	Wen	A45C 11/00	D776,647 S *	1/2017	Kim	D14/25
			D14/25	D777,157 S *	1/2017	Kim	D14/25
D679,271 S *	4/2013	Liu	D13/10	D777,159 S *	1/2017	Lee	D14/25
D679,695 S *	4/2013	Fahrendorff	D14/25	D780,166 S *	2/2017	Lin	D14/25
D680,521 S *	4/2013	Fathollahi	D14/25	D780,167 S *	2/2017	Tien	D14/25
D681,620 S	5/2013	Huskinson		D781,834 S *	3/2017	Kim	D14/25
D685,780 S *	7/2013	Murchison	D14/25	D781,835 S *	3/2017	Kim	D14/25
D689,496 S *	9/2013	Park	D14/434	D781,836 S *	3/2017	Kim	D14/25
D689,497 S *	9/2013	Park	D14/434	D781,837 S *	3/2017	Kim	D14/25
D691,992 S *	10/2013	Murchison	D14/25	D781,838 S *	3/2017	Kim	D14/25
D693,820 S	11/2013	Eastwood		D781,839 S *	3/2017	Kim	D14/25
D694,224 S *	11/2013	Wooseung	D14/24	D781,840 S *	3/2017	Kim	D14/25
D694,759 S *	12/2013	Chang	D14/44	D782,453 S *	3/2017	Kim	D14/24
D696,238 S *	12/2013	Murchison	D14/25	D782,454 S *	3/2017	Kim	D14/24
D696,240 S *	12/2013	Kim	D14/25	D784,309 S *	4/2017	Lee	D14/24
D696,256 S *	12/2013	Piedra	D14/44	D786,256 S	5/2017	Stewart	
D697,503 S *	1/2014	Melanson	D14/25	D786,848 S *	5/2017	Park	D14/24
D702,673 S	4/2014	Murchison		D786,849 S *	5/2017	Park	D14/24
D705,534 S	5/2014	Manjerico		D786,881 S	5/2017	Stewart et al.	
D706,254 S *	6/2014	Chang	D14/21	D789,925 S	6/2017	Browning	
D706,754 S *	6/2014	Goradesky	D14/25	D792,394 S *	7/2017	Lee	D14/34
D707,219 S *	6/2014	Kim	D14/250	D795,237 S *	8/2017	Jung	D13/10
D709,869 S *	7/2014	Witter	D14/25	D795,826 S	8/2017	Yoon	
D712,385 S *	9/2014	Hu	D14/25	D797,715 S *	9/2017	Kim	D14/25
D712,388 S *	9/2014	Jia	D14/25	D797,729 S	9/2017	Park	
D714,276 S *	9/2014	Hu	D14/25	D798,257 S	9/2017	Choo	
D715,051 S *	10/2014	Tung	D3/294	D798,853 S *	10/2017	Park	D14/24
D719,945 S *	12/2014	Chiang	D14/25	D800,112 S	10/2017	Park	
D721,071 S *	1/2015	Nelson	D14/25	D801,322 S *	10/2017	Song	D14/24
D721,360 S *	1/2015	Laffon de Mazieres	D14/25	D806,378 S	1/2018	Lerenthal	
D721,693 S *	1/2015	Lee	D14/25	D807,337 S *	1/2018	Kim	D14/25
D721,694 S *	1/2015	Lee	D14/25	D808,955 S *	1/2018	Park	D14/34
D723,695 S *	3/2015	Chung	D24/169	D810,064 S	2/2018	Kim et al.	
D729,812 S	5/2015	Ahn		D810,067 S	2/2018	Lee	
D732,543 S *	6/2015	Westrup	D14/44	D810,729 S	2/2018	Ballou	
D733,111 S *	6/2015	Kim	D14/25	D823,293 S *	7/2018	Kim	D14/25
9,059,505 B1 *	6/2015	Asrani	H01Q 9/145	D823,294 S *	7/2018	Kim	D14/25
D733,714 S *	7/2015	Ballou	D14/44	D823,296 S *	7/2018	Kim	D14/25
				D823,297 S *	7/2018	Kim	D14/25
				D823,298 S *	7/2018	Kim	D14/25
				D825,542 S *	8/2018	Wikstrom	D14/25
				D830,353 S *	10/2018	Kim	D14/25

(56)

## References Cited

## U.S. PATENT DOCUMENTS

D831,632	S	*	10/2018	Jung	.....	D14/25
D832,245	S	*	10/2018	Jeon	.....	D14/25
D832,268	S	*	10/2018	Mecchella	.....	D14/44
D832,831	S	*	11/2018	Zhang	.....	D14/25
D833,734	S	*	11/2018	Binder	.....	D3/203.6
D835,089	S	*	12/2018	Nelson	.....	D14/25
D835,090	S	*	12/2018	Beck	.....	D14/25
10,162,389	B2		12/2018	Tazbaz		
D838,262	S	*	1/2019	Witter	.....	D14/25
D838,264	S	*	1/2019	Wright	.....	D14/25
D838,265	S	*	1/2019	Wright	.....	D14/25
D838,710	S	*	1/2019	Wang	.....	D14/25
D839,252	S	*	1/2019	Lim	.....	D14/25
D839,859	S	*	2/2019	Zhang	.....	D14/25
D853,373	S		7/2019	Kim		
D854,546	S		7/2019	Mecchella		
D858,500	S		9/2019	Webb et al.		
D859,388	S		9/2019	Chung et al.		
D859,389	S		9/2019	Kim et al.		
D865,745	S		11/2019	Hyun		
D866,964	S		11/2019	Tran et al.		
D868,769	S		12/2019	Choi et al.		
D870,717	S		12/2019	Igarashi		
2014/0111954	A1		8/2014	Lee		
2014/0290009	A1	*	10/2014	Kasai	.....	E05D 3/12 16/386
2015/0195938	A1	*	7/2015	Witter	.....	G06F 1/1656 206/52
2015/0245522	A1	*	8/2015	Kang	.....	H04M 1/0252 361/72
2015/0180526	A1	*	9/2015	Hidaka	.....	G06F 1/1637 455/57
2015/0370287	A1		12/2015	Ko		
2016/0058143	A1	*	3/2016	Tien	.....	A45C 11/00 224/19
2016/0187935	A1		6/2016	Tazbaz		
2016/0198026	A1	*	7/2016	Del Toro	.....	H04B 1/3888 455/57
2016/0349802	A1		12/2016	Ahn		

## OTHER PUBLICATIONS

Spigen Ultra Hybrid Galaxy A5 2017 Case with Air Cushion Technology and Hybrid Drop Protection for Samsung Galaxy A5 (2017)—Crystal Clear, <https://www.amazon.com/dp/B01NCJOZ1C>, Earliest review date of Mar. 2, 2017, Downloaded on Jan. 8, 2019.\*

“Spigen Ultra Hybrid Galaxy S8 Plus Case with Air Cushion Technology and Hybrid Drop Protection for Galaxy S8 Plus (2017)—Crystal Clear”, <https://www.amazon.com/dp/B06XP7S564> Earliest review date of Apr. 4, 2017, Downloaded on Aug. 8, 2018.\*

“Spigen Ultra Hybrid Galaxy S8 Case with Air Cushion Technology and Hybrid Drop Protection for Samsung Galaxy S8 (2017)—Crystal Clear”, <https://www.amazon.com/dp/B06XP5YQNNQ>, Earliest review date of Apr. 7, 2017, Downloaded on Jul. 30, 2018.\*

“Spigen Ultra Hybrid S Galaxy S8 Plus Case with Air Cushion Technology and Magnetic Metal Kickstand for Galaxy S8 Plus (2017)—Crystal Clear”, <https://www.amazon.com/dp/B06XNSZJ31>, Earliest review date of Apr. 9, 2017, Downloaded on Aug. 8, 2018.\*

“Spigen Ultra Hybrid Google Pixel XL Case with Air Cushion Technology and Hybrid Drop Protection for Google Pixel XL 2016—Crystal Clear”, <https://www.amazon.com/dp/B01M12Z4VQ>, Earliest review date of Oct. 21, 2016, Downloaded on Jan. 8, 2019.\*

“Spigen Ultra Hybrid [2nd Generation] iPhone 8 Plus Case/iPhone 7 Plus Case with Clear Protection and Air Cushion Technology for iPhone 8 Plus (2017) / iPhone 7 Plus (2016)—Crystal Clear”, <https://www.amazon.com/dp/B01MXKNPQ5>, Earliest review date of Jan. 9, 2017, Downloaded on Jan. 8, 2019.\*

“Spigen Ultra Hybrid S iPhone Seven Plus Case with Air Cushion Technology and Magnetic Metal Kickstand for Apple iPhone Seven

Plus Two Thousand and Sixteen Clear Black”, <https://www.amazon.com/dp/B01LRSF986>, Earliest review date of Sep. 7, 2016, Downloaded on Jan. 8, 2019.\*

“Spigen Ultra Hybrid S iPhone 7 Case with Air Cushion Technology and Magnetic Metal Kickstand for iPhone 7 2016—Crystal Clear”, <https://www.amazon.com/dp/B01J9DVBWE>, Earliest review date of Sep. 13, 2016, Downloaded on Jan. 8, 2019.\*

“Spigen Ultra Hybrid Designed for Apple iPhone Xs Case (2018) / Designed for Apple iPhone X Case (2017)—Crystal Clear”, <https://www.amazon.com/dp/B074CMMCZM>, Earliest review date of Sep. 13, 2017, Downloaded on Jan. 8, 2019.\*

“Spigen Ultra Hybrid S [2nd Generation] iPhone 8 Case/iPhone 7 Case with Air Cushion Technology and Magnetic Metal Kickstand for Apple iPhone 8 (2017) / iPhone 7 (2016)—Crystal Clear”, <https://www.amazon.com/dp/B07482GSK2>, Earliest review date of Sep. 13, 2017, Downloaded on Jan. 8, 2019.\*

“Spigen Ultra Hybrid S [2nd Generation] iPhone 8 Plus Case/iPhone 7 Plus Case with Air Cushion Technology and Kickstand for Apple iPhone 8 Plus (2017) / iPhone 7 Plus (2016)—Crystal Clear”, <https://www.amazon.com/dp/B074833H3M>, Earliest review date of Sep. 30, 2017, Downloaded on Jan. 8, 2019.\*

“Spigen Ultra Hybrid S Designed for Apple iPhone Xs Case (2018) / Designed for Apple iPhone X Case (2017)—Crystal Clear”, <https://www.amazon.com/dp/B074CMHVKY>, Earliest review date of Oct. 19, 2017, Downloaded on Jan. 8, 2019.\*

“Spigen Ultra Hybrid Sony Xperia XZ1 Case with Air Cushion Technology and Hybrid Drop Protection for Sony Xperia XZ1 (2017)—Crystal Clear”, <https://www.amazon.com/dp/B075DWY35G>, Earliest review date of Dec. 11, 2017, Downloaded on Jan. 8, 2019.\*

“Spigen Ultra Hybrid OnePlus 5 Case with Air Cushion Technology and Hybrid Drop Protection for OnePlus 5 (2017)—Crystal Clear”, <https://www.amazon.com/dp/B06XFSQFMW>, Earliest review date of Aug. 20, 2017, Downloaded on Jan. 9, 2019.\*

“Spigen Ultra Hybrid S Galaxy Note 8 Case with Air Cushion Technology and Magnetic Metal Kickstand for Galaxy Note 8 (2017)—Crystal Clear”, <https://www.amazon.com/dp/B073RWFZQH>, Earliest review date of Sep. 8, 2017, , Downloaded on Jul. 30, 2018.\*

“Spigen Ultra Hybrid Galaxy A7 2017 Case with Air Cushion Technology and Hybrid Drop Protection for Samsung Galaxy A7 (2017)—Crystal Clear”, <https://www.amazon.com/dp/B01N9JD0MH>, Earliest review date of May 6, 2017, Downloaded on Aug. 8, 2018.\*

“Spigen Ultra Hybrid Sony Xperia XZ Premium Case with Air Cushion Technology and Hybrid Drop Protection for Sony Xperia XZ Premium (2017)—Crystal Clear”, <https://www.amazon.com/dp/B071VZ1176>, Earliest review date of Jul. 15, 2017, Downloaded on Jan. 8, 2019.\*

“Spigen Ultra Hybrid Tech iPhone 6S Plus Case with Bumper Protection for iPhone 6S Plus 2015—Crystal White”, <https://www.amazon.com/dp/B013TKNIOC>, Earliest review date of Oct. 26, 2015, Downloaded on Jan. 4, 2019.\*

“Spigen Ultra Hybrid Galaxy S7 Edge Case with Air Cushion Technology and Hybrid Drop Protection for Samsung Galaxy S7 Edge 2016—Rose Crystal”, <https://www.amazon.com/dp/B01AUR0Z1G>, Earliest review date of Feb. 24, 2016, Downloaded on Aug. 8, 2018.\*

“iPhone 6s Plus Case, Spigen [Ultra Hybrid] Air Cushion [Crystal Clear] Clear back panel + TPU bumper for iPhone 6 Plus (2014) / 6s Plus (2015)—Crystal Clear (SGP11644)”, <https://www.amazon.com/dp/B010MVRC20>, Earliest review date of Sep. 15, 2015, Downloaded on Jan. 4, 2019.\*

“Spigen Ultra Hybrid Nexus 5X Case with Air Cushion Technology and Hybrid Drop Protection for Nexus 5X—Crystal Clear”, <https://www.amazon.com/dp/B0147JXWG8>, Earliest review date of Sep. 24, 2015, Downloaded on Jan. 8, 2019.\*

“Spigen Ultra Hybrid Galaxy A5 Case with Air Cushion Technology and Hybrid Drop Protection for Galaxy A5—Crystal Clear”, <https://www.amazon.com/dp/B018J07DOI>, Earliest review date of May 23, 2016, Downloaded on Aug. 8, 2018.\*

“Spigen Ultra Hybrid iPhone 7 Case with Air Cushion Technology and Hybrid Drop Protection for iPhone 7 2016—Black”, <https://www.amazon.com/dp/B01GIVXBVY>, Earliest review date of Sep. 1, 2016, Downloaded on Jan. 8, 2019.\*

(56)

**References Cited**

## OTHER PUBLICATIONS

“Spigen Ultra Hybrid iPhone 7 Plus Case with Air Cushion Technology and Hybrid Drop Protection for Apple iPhone 7 Plus 2016—Crystal Clear”, <https://www.amazon.com/dp/B01GIWGFMU>, Earliest review date of Sep. 6, 2016, Downloaded on Jan. 8, 2019.\*

“Spigen Ultra Hybrid Galaxy S7 Case with Air Cushion Technology and Hybrid Drop Protection for Samsung Galaxy S7 2016—Crystal Clear”, <https://www.amazon.com/dp/B01A7ID0AG>, Earliest review date of Feb. 29, 2016, Downloaded on Aug. 8, 2018.\*

“Spigen Ultra Hybrid iPhone SE Case with Air Cushion Technology and Hybrid Drop Protection for iPhone SE 2016—Crystal Clear”, <https://www.amazon.com/dp/B01BEDO0OS>, Earliest review date of Apr. 15, 2016, Downloaded on Jan. 4, 2019.\*

“Spigen Ultra Hybrid Galaxy Note 4 Case with Air Cushion Technology and Hybrid Drop Protection for Samsung Galaxy Note 4 2014—Crystal Clear”, <https://www.amazon.com/dp/B00MAWPVXM>, Earliest review date of Oct. 17, 2014, Downloaded on Aug. 8, 2018.\*

“Spigen Ultra Hybrid Galaxy S6 Case with Air Cushion Technology and Hybrid Drop Protection for Galaxy S6 2015—Crystal Clear”, <https://www.amazon.com/dp/B00QU4PN84>, Earliest review date of Feb. 6, 2015, Downloaded on Aug. 8, 2018.\*

“Spigen Ultra Hybrid Galaxy S6 Edge Case with Air Cushion Technology and Hybrid Drop Protection for Galaxy S6 Edge 2015—Metal Slate”, <https://www.amazon.com/dp/B00SV63NNG>, Earliest review date of Mar. 30, 2015, Downloaded on Aug. 8, 2018.\*

“Spigen Ultra Hybrid Galaxy S6 Edge Plus Case with Air Cushion Technology and Hybrid Drop Protection for Galaxy S6 Edge Plus 2015—Mint”, <https://www.amazon.com/dp/B010MWFRFI>, Earliest review date of Aug. 18, 2015, Downloaded on Aug. 8, 2018.\*

“Spigen Ultra Hybrid iPhone 6S Case with Air Cushion Technology and Hybrid Drop Protection for iPhone 6S / iPhone 6—Crystal Clear”, <https://www.amazon.com/dp/B010MVJNTK>, Earliest review date of Aug. 31, 2015, Downloaded on Dec. 28, 2018.\*

“Spigen Ultra Hybrid iPhone 6 Case with Air Cushion Technology and Hybrid Drop Protection for iPhone 6S / iPhone 6—Crystal

Clear”, <https://www.amazon.com/dp/B00JH88D1O>, Earliest review date of Jul. 10, 2014, Downloaded on Dec. 28, 2018.\*

“Spigen Ultra Hybrid Galaxy Note 4 Case with Air Cushion Technology and Hybrid Drop Protection for Samsung Galaxy Note 4 2014—Gunmetal”, <https://www.amazon.com/dp/B00MAWPXVW>, Earliest review date of Oct. 15, 2014, Downloaded on Aug. 8, 2018.\*

“Spigen Ultra Hybrid iPhone 5S / 5 Case with Air Cushion Technology and Hybrid Drop Protection for iPhone 5S / iPhone 5—Crystal Clear”, <https://www.amazon.com/dp/B00G3JCFNC>, Earliest review date of Sep. 10, 2013, Downloaded on Jan. 4, 2019.\*

“Spigen Ultra Hybrid Nexus 5 Case with Air Cushion Technology and Hybrid Drop Protection for Nexus 5—Black”, <https://www.amazon.com/dp/B00FJJ38HY>, Earliest review date of Nov. 1, 2013, Downloaded on Jan. 8, 2019.\*

“Spigen Ultra Hybrid [2nd Generation] iPhone 7 Case/iPhone 8 Case with Air Cushion Technology for Apple iPhone 7 (2016)/iPhone 8 (2017)—Crystal Clear”, <https://www.amazon.com/dp/B01M0USRWG>, Earliest review date of Jan. 17, 2017, Downloaded on Jan. 8, 2019.

“Spigen Ultra Hybrid OnePlus 5 Case with Air Cushion Technology and Hybrid Drop Protection for OnePlus 5 (2017)—Crystal Clear”, <https://www.amazon.com/dp/B06XFSQFMW>, Earliest review date of Aug. 20, 2017, Downloaded on Jan. 8, 2019.

“Spigen Ultra Hybrid Galaxy Note 8 Case with Air Cushion Technology and Hybrid Drop Protection for Galaxy Note 8 (2017)—Midnight Black”, <https://www.amazon.com/dp/B073RWN5QP>, Earliest review date of Sep. 3, 2017, Downloaded on Aug. 8, 2018.

“Review: Griffin Reveal Case for iPhone 5”, <http://www.ilounge.com/index.php/reviews/entry/griffin-reveal-case-for-iphone-5/>, Earliest review date of Oct. 16, 2012, Downloaded on Feb. 6, 2019.

“Review: Griffin Reveal for iPhone 5c”, <http://www.ilounge.com/index.php/reviews/entry/griffin-reveal-for-iphone-5c/>, Earliest review date of Oct. 10, 2013, Downloaded on Feb. 5, 2019.

“Spigen Ultra Hybrid Galaxy S8 Case with Air Cushion Technology and Hybrid Drop Protection for Galaxy S8 2015—Midnight Black”, <https://www.amazon.com/DP/B06XP7JTRC>, Earliest review date of Apr. 10, 2017, Downloaded on Jul. 30, 2018.

\* cited by examiner

**FIG. 1**

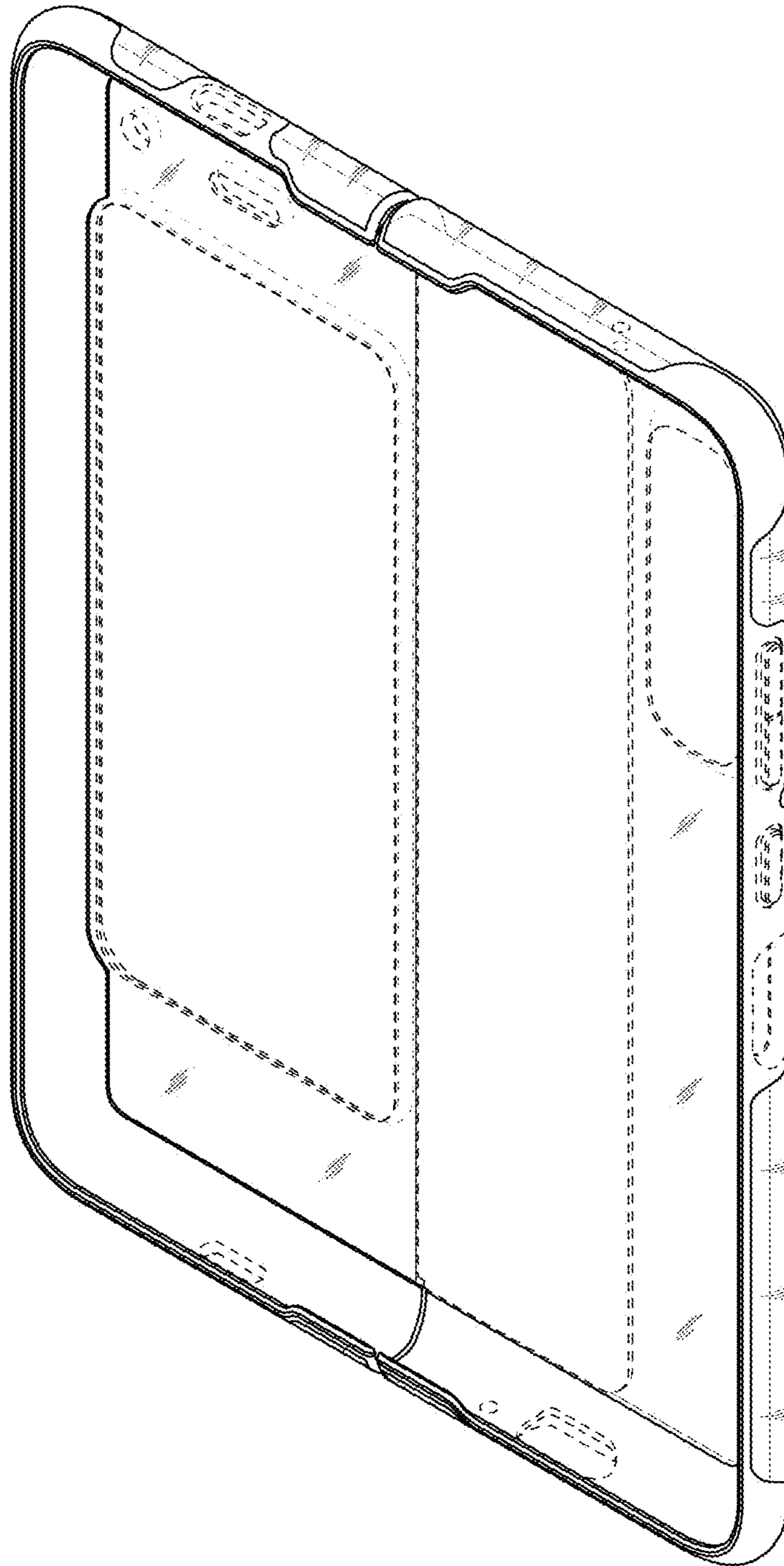

**FIG. 2**

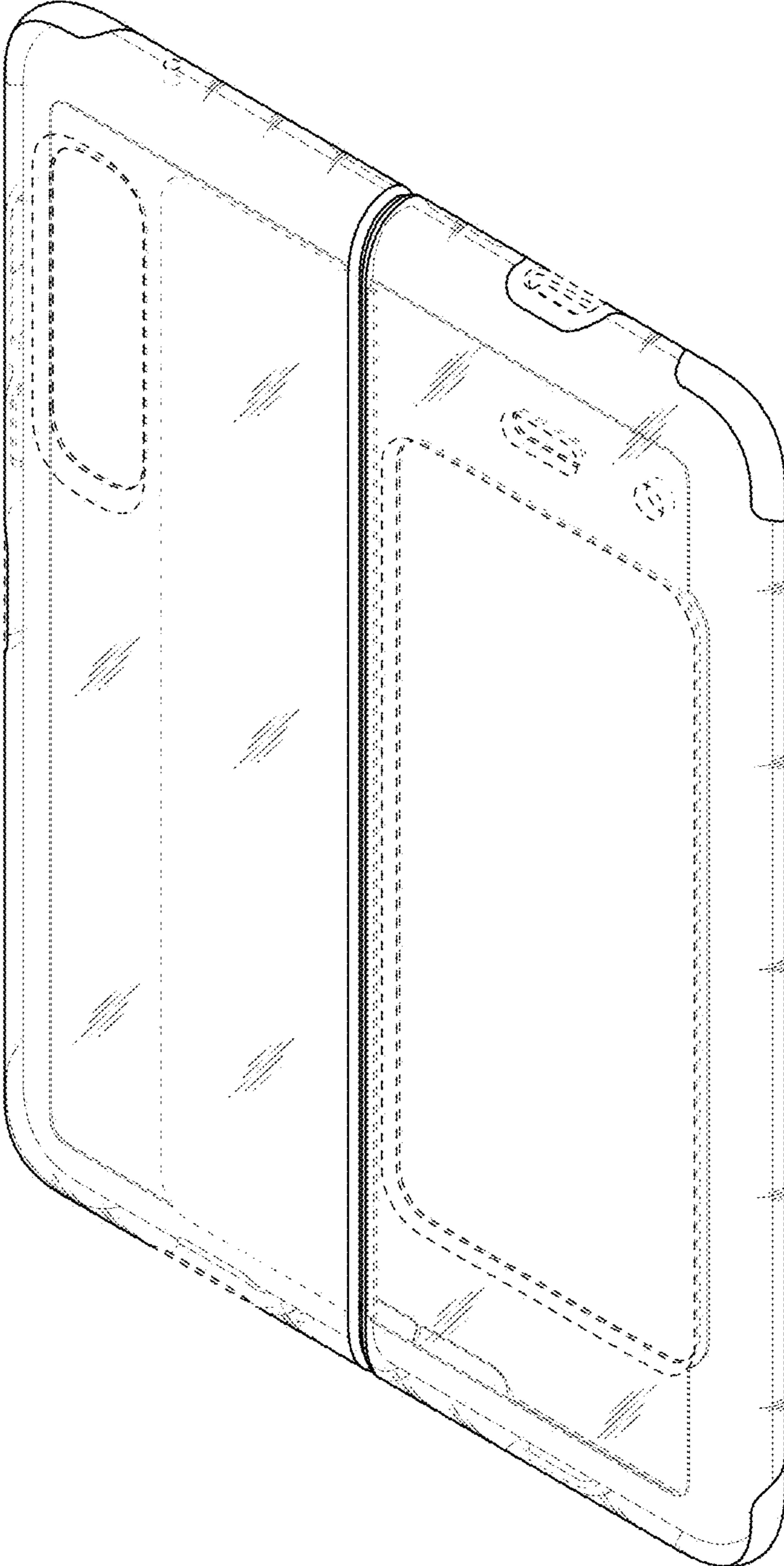
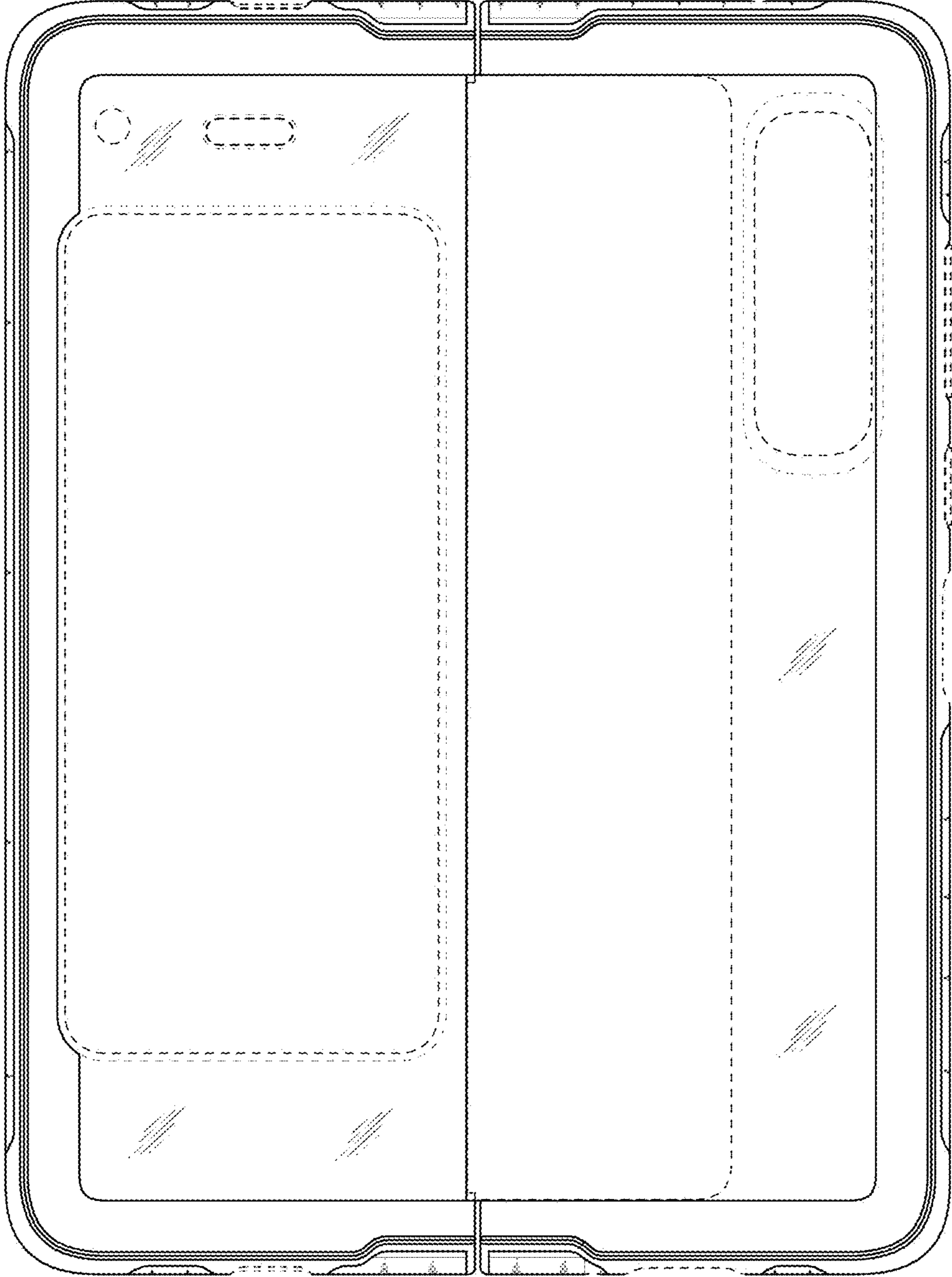
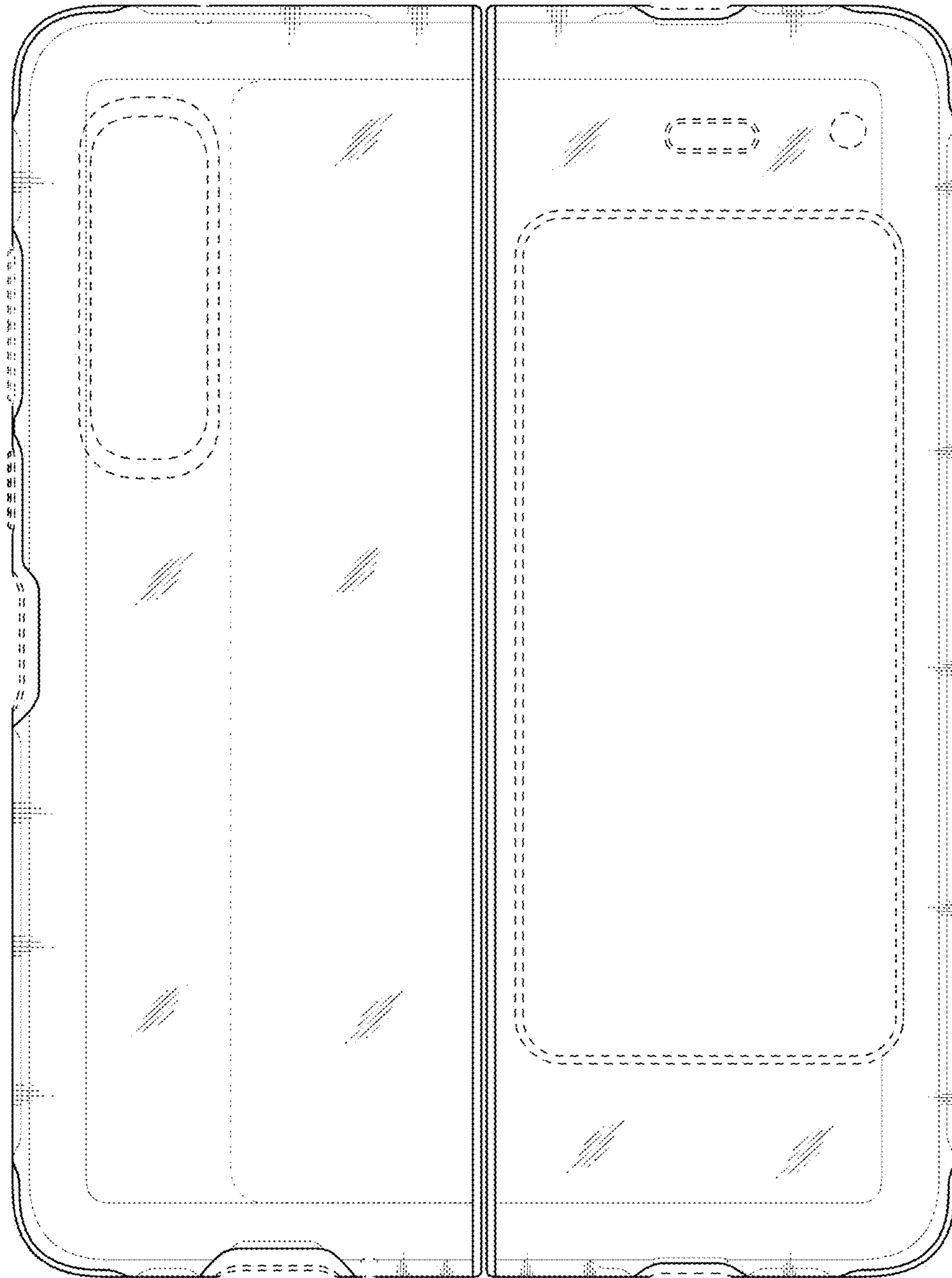

FIG. 3

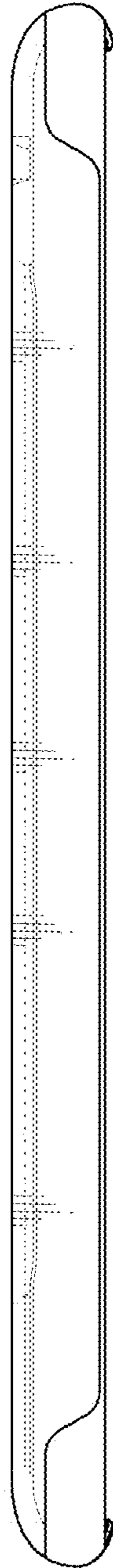

**FIG. 4**

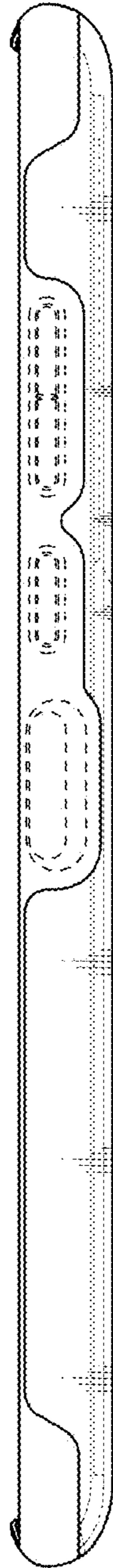



**FIG. 5**



**FIG. 6**



**FIG. 7**

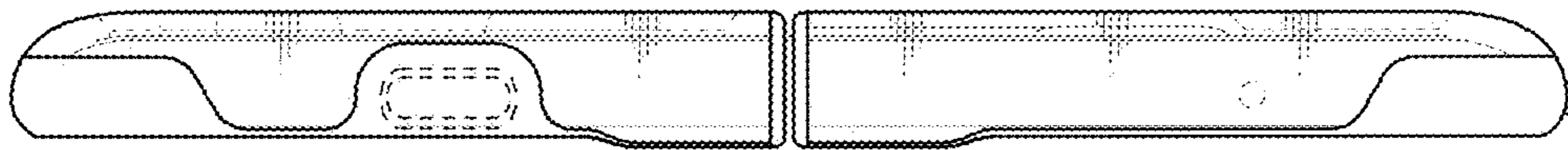

**FIG. 8**

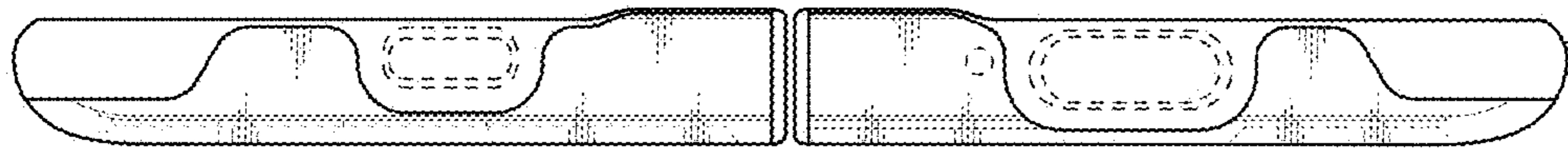

**FIG. 9**

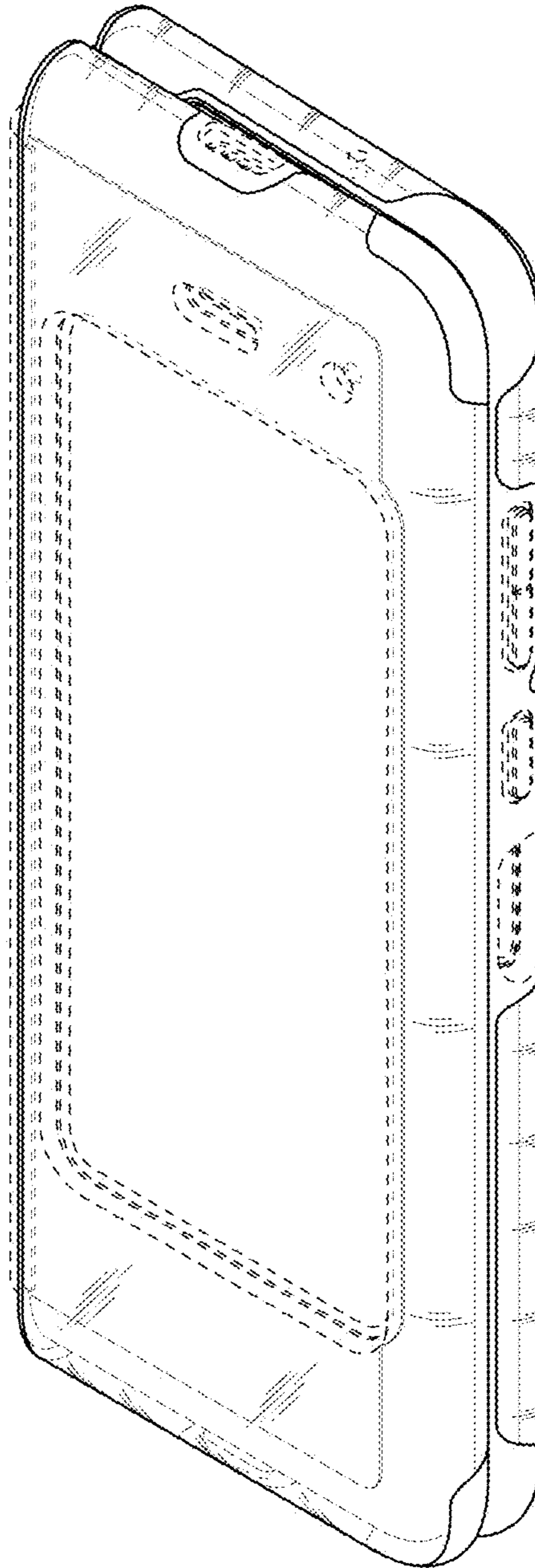

**FIG. 10**

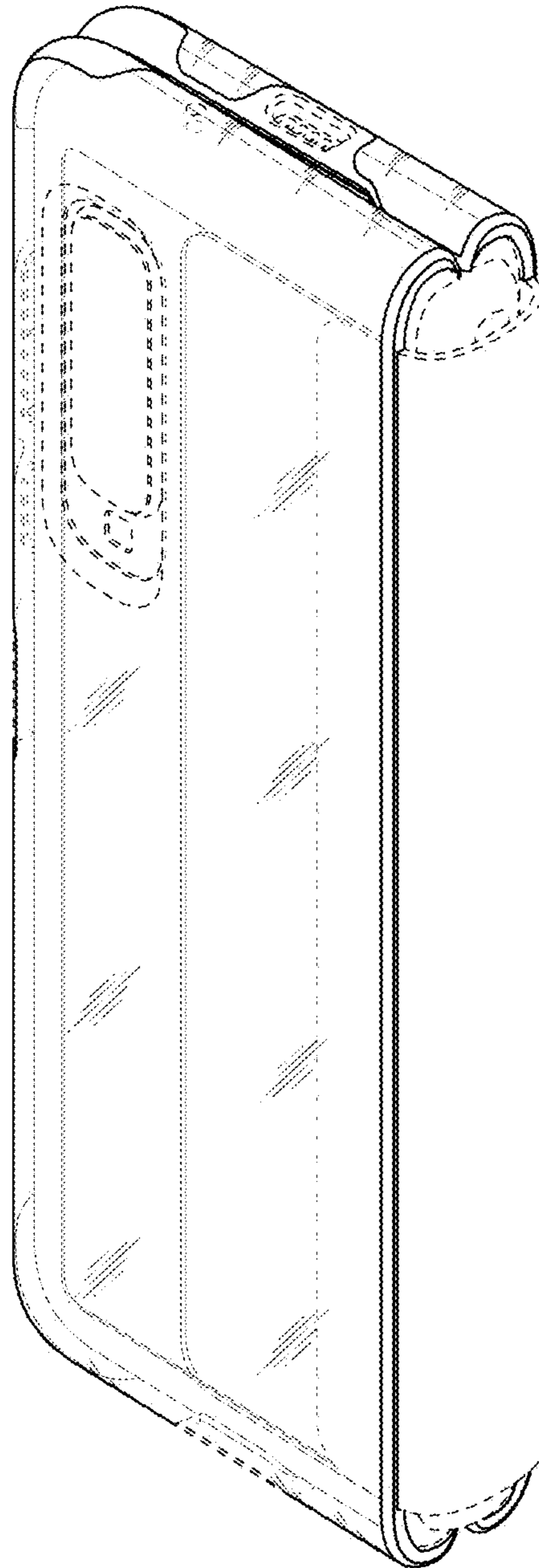

**FIG. 11**

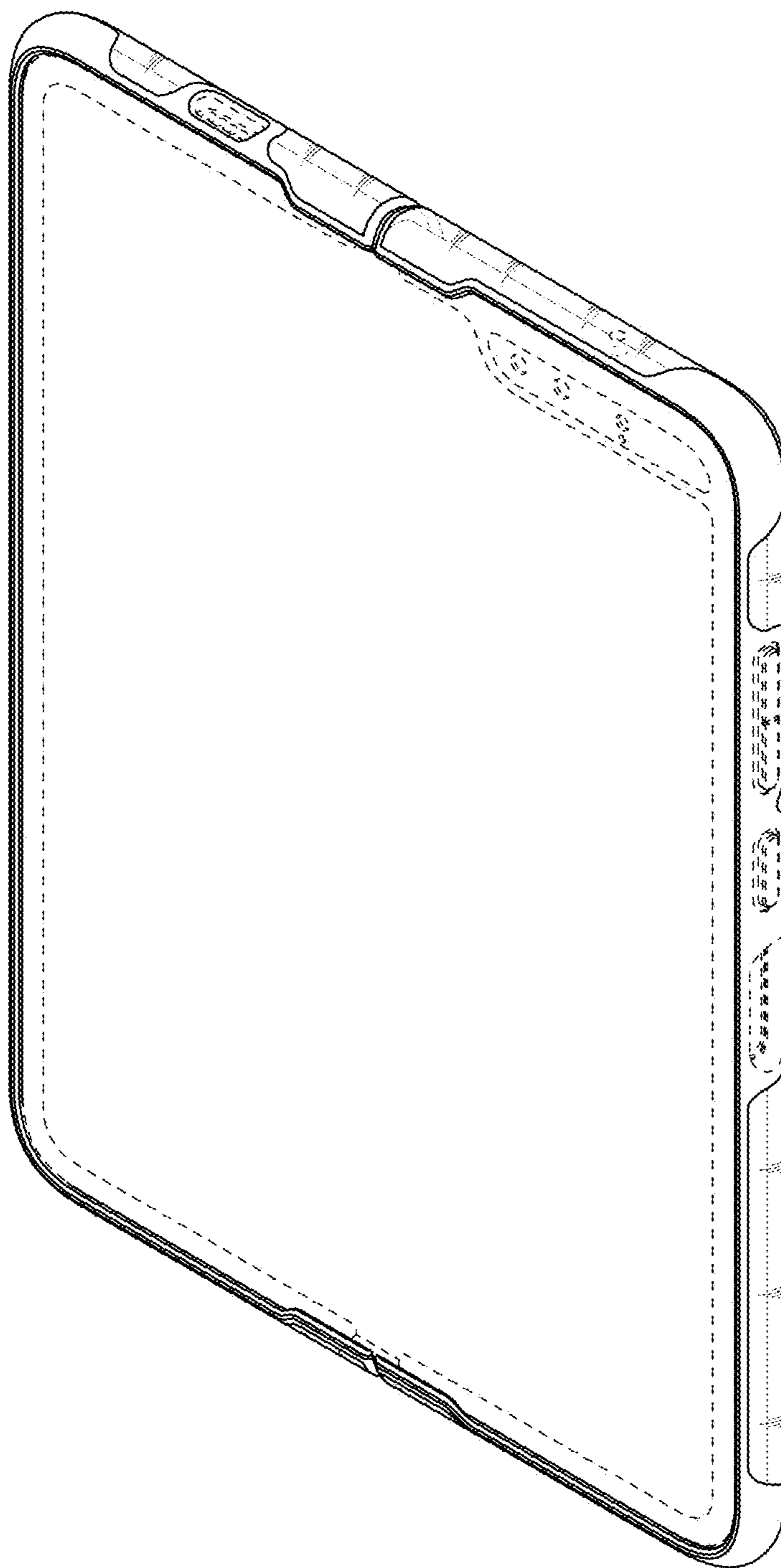

**FIG. 12**

