



US00D915380S

(12) **United States Design Patent** (10) **Patent No.:** **US D915,380 S**
Ahn (45) **Date of Patent:** **** Apr. 6, 2021**

(54) **CASE FOR ELECTRONIC COMMUNICATIONS DEVICE**
(71) Applicant: **SPIGEN KOREA CO., LTD.**, Seoul (KR)
(72) Inventor: **Deok Hyun Ahn**, Seoul (KR)
(73) Assignee: **SPIGEN KOREA CO., LTD.**, Seoul (KR)
(**) Term: **15 Years**
(21) Appl. No.: **29/702,953**
(22) Filed: **Aug. 22, 2019**
(51) **LOC (13) Cl.** **14-03**
(52) **U.S. Cl.**
USPC **D14/250**
(58) **Field of Classification Search**
USPC D3/201, 218, 226, 227, 247, 249, 250, D3/269, 303; D13/103, 107, 108, 119; D14/137, 138 R, 138 AA, 138 C, 138 G, D14/172, 192, 203.3–203.7, 217, 238.1, D14/247, 248, 250–253, 434, 440, 447, D14/496
CPC H04B 1/3888; H04M 1/0283; H04M 1/0202; A45C 1/06; A45C 2011/002; A45C 11/00; A45F 2005/028; A45F 2200/0525
See application file for complete search history.

D644,216 S 8/2011 Richardson
D648,332 S * 11/2011 Kim D14/248
D652,825 S 1/2012 Bau
D652,828 S 1/2012 Fahrendorff
D654,460 S * 2/2012 Kim D14/138 G
(Continued)

OTHER PUBLICATIONS

Spigen Samsung S10 La Manon Classy Case, publication date Feb. 20, 2019, [online][site visited Feb. 13, 2020] URL: <https://www.sgmobile.solutions/collections/galaxy-s10-1/products/s10-la-manon-classy-case> (Year: 2019).*

(Continued)

Primary Examiner — L. A. Grabenstetter
(74) *Attorney, Agent, or Firm* — Heedong Chae; Lucem, PC

(57) **CLAIM**

The ornamental design for a case for electronic communications device, as shown and described.

DESCRIPTION

FIG. 1 is a front perspective view of a case for electronic communications device showing my new design; FIG. 2 is a rear perspective view thereof; FIG. 3 is a front elevational view thereof; FIG. 4 is a rear elevational view thereof; FIG. 5 is a left side elevational view thereof; FIG. 6 is a right side elevational view thereof; FIG. 7 is a top plan view thereof; FIG. 8 is a bottom plan view thereof; and, FIG. 9 is an enlarged detail view of the encircled region of FIG. 2.

The dot-dash broken line circle in FIG. 2 delineates a portion of the case for electronic communications device that is part of the claimed design and is shown on an enlarged scale in FIG. 9.

1 Claim, 9 Drawing Sheets

(56) **References Cited**

U.S. PATENT DOCUMENTS

320,567 A 2/1885 Lord
D420,363 S 2/2000 Arrington
D453,749 S * 2/2002 Lee D14/138 AB
6,974,080 B1 * 12/2005 Goggins G06K 19/06046
235/462.01
D606,532 S 12/2009 de Jong
D619,361 S 7/2010 Andre et al.
D620,703 S 8/2010 Jacobs

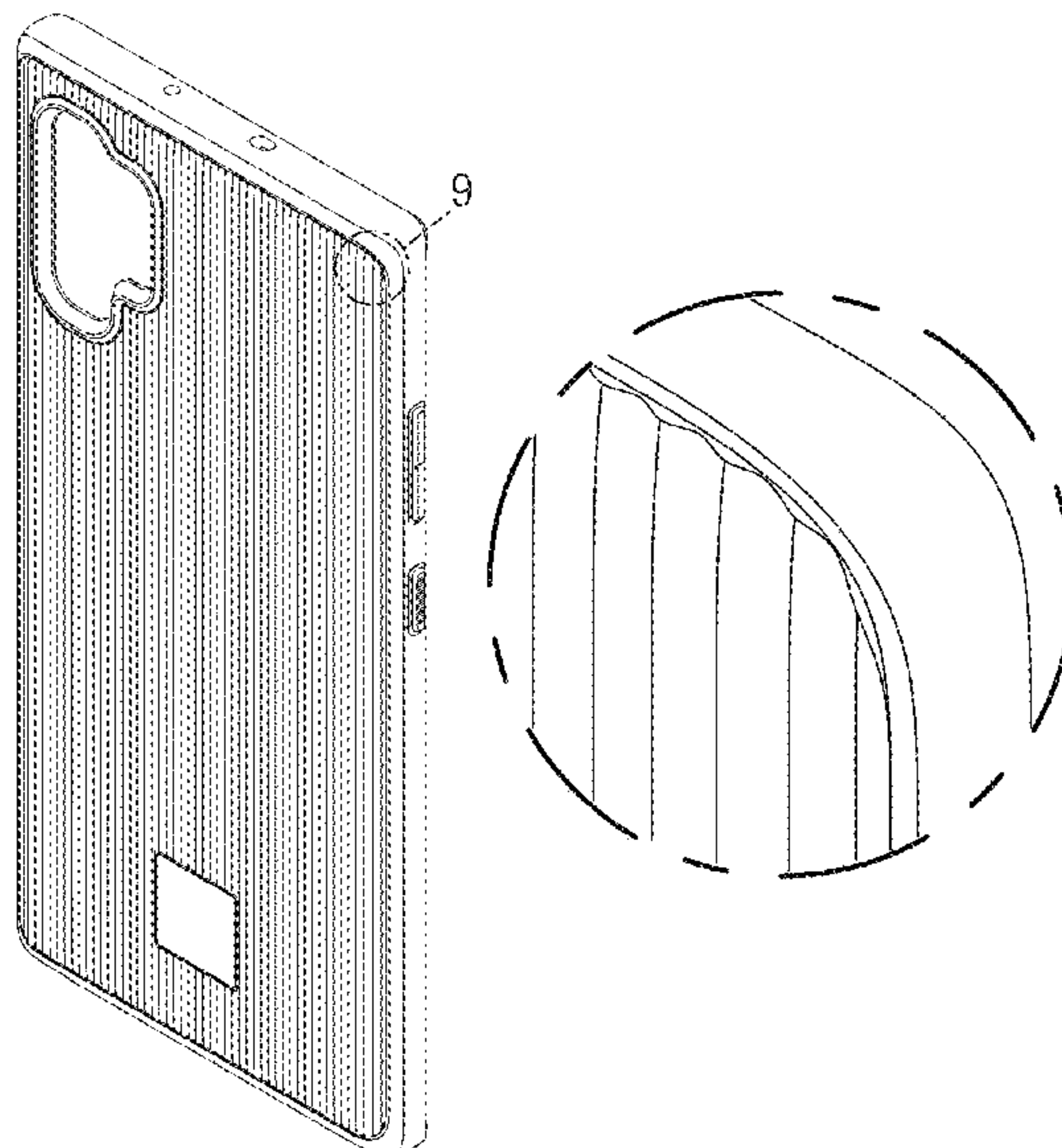

(56)

References Cited

U.S. PATENT DOCUMENTS

D655,281 S 3/2012 Turocy
 D659,691 S * 5/2012 Kim D14/250
 D668,646 S 10/2012 Li
 D669,889 S 10/2012 Li et al.
 D673,147 S * 12/2012 Tang D14/341
 D673,550 S 1/2013 Magness et al.
 D678,327 S * 3/2013 Lee D14/203.3
 D678,328 S 3/2013 Lee et al.
 D681,617 S 5/2013 Weller et al.
 D682,239 S 5/2013 Yeh
 D683,136 S 5/2013 Wilson
 D690,292 S 9/2013 Bibla
 D691,122 S 10/2013 Bau
 D691,601 S 10/2013 Murchison et al.
 D694,759 S 12/2013 Chang
 D695,729 S * 12/2013 Shi D14/248
 D697,060 S 1/2014 Yang
 D700,174 S 2/2014 Li
 D703,656 S 4/2014 Witter
 D709,484 S * 7/2014 Yoo D14/250
 D709,869 S 7/2014 Witter et al.
 D714,273 S 9/2014 Kim et al.
 D716,783 S 11/2014 Loncar et al.
 D721,686 S 1/2015 Jacob et al.
 D721,694 S 1/2015 Lee et al.
 D724,065 S 3/2015 Fathollahi
 D727,028 S 4/2015 Feng
 D727,303 S * 4/2015 Sin D14/248
 D732,525 S 6/2015 Seo et al.
 D734,747 S 7/2015 Seo et al.
 D735,182 S 7/2015 Watkins et al.
 D737,259 S 8/2015 Choi
 D741,845 S 10/2015 Kim
 D746,273 S 12/2015 Herbst
 D746,274 S 12/2015 Herbst
 D749,068 S 2/2016 Zaborski et al.
 D749,078 S 2/2016 Bertrand
 D749,535 S 2/2016 Joung et al.
 D749,557 S 2/2016 Feng
 D750,606 S 3/2016 Lu et al.
 D751,058 S 3/2016 Cocchia et al.
 D761,773 S * 7/2016 Choi D14/248
 D762,202 S 7/2016 Tseng
 D762,204 S * 7/2016 Armstrong D14/250
 D763,241 S 8/2016 Kim
 D763,242 S 8/2016 Kim
 D763,837 S 8/2016 Choe et al.
 D765,627 S 9/2016 Watt
 D765,635 S 9/2016 Chang et al.
 D765,638 S 9/2016 Gaylord et al.
 D765,641 S 9/2016 Bulkley et al.
 D765,642 S 9/2016 Bulkley
 D765,645 S 9/2016 Kim
 D767,485 S 9/2016 To et al.
 D771,027 S 11/2016 Prstojevič
 D771,611 S 11/2016 Chang et al.
 9,480,319 B2 11/2016 Dining et al.
 D776,647 S 1/2017 Kim
 D776,649 S 1/2017 Kim
 D777,157 S 1/2017 Kim
 D777,160 S 1/2017 Kim
 D780,165 S 2/2017 Lee
 D781,840 S 3/2017 Kim et al.
 D782,460 S 3/2017 Bertrand
 D784,309 S 4/2017 Lee et al.
 D785,615 S 5/2017 Kim et al.
 D786,849 S 5/2017 Park et al.
 D786,851 S 5/2017 Kim
 D786,853 S 5/2017 Friedland et al.
 D787,491 S 5/2017 Kim
 D788,093 S 5/2017 Lee et al.
 D789,347 S * 6/2017 Zamudio D14/250
 D791,113 S 7/2017 Tien
 D792,394 S 7/2017 Lee et al.
 D795,237 S 8/2017 Jung et al.

D797,715 S 9/2017 Kim
 D798,286 S 9/2017 Roberts et al.
 D798,834 S * 10/2017 Fan D14/138 G
 D798,853 S 10/2017 Park et al.
 D801,322 S 10/2017 Song et al.
 D801,323 S 10/2017 Kim
 D806,082 S 12/2017 Armstrong et al.
 D808,955 S 1/2018 Park et al.
 D809,495 S 2/2018 Dukerschein et al.
 D816,651 S 5/2018 Chiang et al.
 D831,638 S 10/2018 Kim
 D832,833 S 11/2018 Kim
 D834,571 S 11/2018 Ravid
 D836,095 S 12/2018 Kim et al.
 D840,990 S 2/2019 Kim
 D840,991 S 2/2019 Kim
 D840,992 S 2/2019 Kim
 D851,638 S * 6/2019 Kim D14/250
 D853,376 S * 7/2019 Jeong D14/250
 2003/0044579 A1 * 3/2003 Bolton B32B 3/30
 428/167
 2012/0177889 A1 * 7/2012 Uematsu D04H 1/76
 428/167
 2013/0058016 A1 * 3/2013 Shi G02B 3/005
 361/679.01
 2016/0164565 A1 6/2016 Witter

OTHER PUBLICATIONS

Spigen La Manon CLassy Huawei P30 pro case, publication date Apr. 27, 2019, [online][site visited Feb. 13, 2020] URL: <https://www.youtube.com/watch?v=6vLCQOKc2ng> (Year: 2019).*

Qitayo Vertical Stripes Case for Samsung Galaxy S10e, publication date Feb. 15, 2019, [online][site visited Feb. 13, 2020] URL: <https://www.amazon.com/QITAYO-Compatible-Samsung-Protection-Vertical/dp/B07N7WVLLG> (Year: 2019).*

La Manon Classy Design for Apple iPhone XS, publication date Sep. 14, 2018, [online][site visited Feb. 13, 2020] URL: <https://www.amazon.com/CYRILL-Manon-Classy-Designed-iPhone/dp/B07H59G3DG> (Year: 2018).*

“iPhone 6S Plus Case, Leminimo(TM) Anti Shock Design TPU Flexible Case for iPhone 6 6S Plus [5.5 inch Display] Striped Sailor Print Pattern Slim Fit Snap on Shell Full Protection Case”, <https://www.amazon.com/dp/B018R3D710>, earliest review date of Jan. 25, 2016, downloaded on Mar. 26, 2020.

“Vertical Thin Navy Stripes OtterBox iPhone Case”, https://www.zazzle.com/vertical_thin_navy_stripes_otterbox_iphone_case-256416992751957315, earliest review date of May 4, 2016, Downloaded on Mar. 26, 2020.

“Tendlin iPhone 7 Case/iPhone 8 Case with Wood Grain Outside Soft TPU Silicone Hybrid Slim Case for iPhone 7 and iPhone 8(Black Rose Wood)”, <https://www.amazon.com/dp/B01KONHGUE>, earliest review date of Aug. 18, 2016, Downloaded on Mar. 26, 2020.

“For iPhone 8 Plus Case Stripes, for iPhone 7 Plus Case Stripes, Gifun Anti-Slide Soft TPU Premium Flexible Protective case for iPhone 8 Plus/for iPhone 7 Plus—Minimal Stripes and Rose Gold”, <https://www.amazon.com/dp/B077ZRD4Y3>, earliest review date of Nov. 19, 2016, downloaded on Mar. 26, 2020.

“Case-Mate—iPhone 8 Case—Tough Groove—Textured—Protective Design—Iridescent”, <https://www.amazon.com/dp/B07VGTRHBT>, earliest review date of Oct. 12, 2017, downloaded on Mar. 26, 2020.

“LeYi iPhone 6 Case, iPhone 6s Case with Tempered Glass Screen Protector [2 Pack], 3D Stripe Carbon Fiber Design Slim Silicone TPU Full Protective Phone Cover Case for Apple iPhone 6/6S, Matte Black”, <https://www.amazon.com/dp/B082PT16MZ>, earliest review date of Mar. 1, 2018, downloaded on Mar. 26, 2020.

“JLFCH iPhone 8 Plus Slim Case, iPhone 7 Plus Case with Shockproof Airbag Protective Back Cover for Apple iPhone 1/8 Plus, 5.5 inch—Black & White Vertical Stripes”, <https://www.amazon.com/dp/B07GP9XZ8P>, earliest review date of Sep. 11, 2018, downloaded on Mar. 26, 2020.

(56)

References Cited

OTHER PUBLICATIONS

“iPhone 6 & iPhone 6s case for Girls, Akna High Impact Flexible Silicon Case for Both iPhone 6 & iPhone 6s (Design 531-U.S)”, <https://www.amazon.com/Akna-Collection-Flexible-Silicon-531-U-S/dp/B0753DLG3M>, Earliest review date of Dec. 24, 2015, Downloaded May 26, 2020.

“Kate Spade Flexible Hardshell Case for (phone 6/6s—Rose Gold Diagonal Stripe”, <https://www.amazon.com/Kate-Spade-Flexible-Hardshell-Iphone/dp/B01922O4AS>, Earliest review date of Jan. 25, 2016, Downloaded May 26, 2020.

“OtterBox Symmetry Clear Series Case for iPhone Xs & iPhone X—Retail Packaging—Inside the Lines Clear/Inside the Lines)”, <https://www.amazon.com/OtterBox-Symmetry-Clear-Case-iPhone/dp/B00Z7ST4P2>, Earliest review date of Oct. 9, 2017, Downloaded May 26, 2020.

“Ultra [Slim Thin] Scratch Resistant Protective Case Cover for iPhone Xs/iPhone X(iPhone 10) Black and White Pattern”, <https://www.amazon.com/Scratch-Resistant-Protective-iPhone-Pattern/dp/B075H98TTP>, Earliest review date of Nov. 18, 2017, Downloaded May 26, 2020.

“Bondir, iPhone XR, Black Stripe (Black, Clear) [Military Drop Test Certified] Protective Clear Case for Apple (6.1") Phone XR”, <https://www.amazon.com/Bondir-iPhone-Military-Certified-Protective/dp/B07FTVJD18>, Earliest review date of Sep. 25, 2018, Downloaded May 26, 2020.

* cited by examiner

FIG. 1

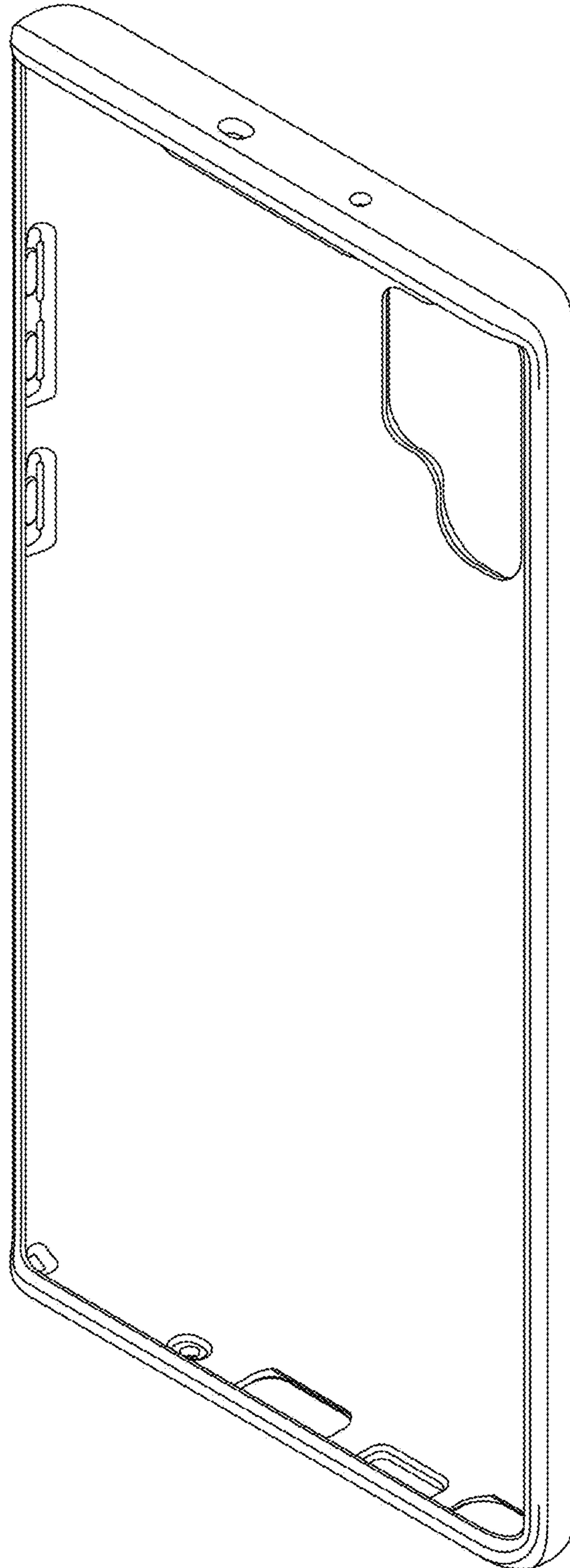

FIG. 2

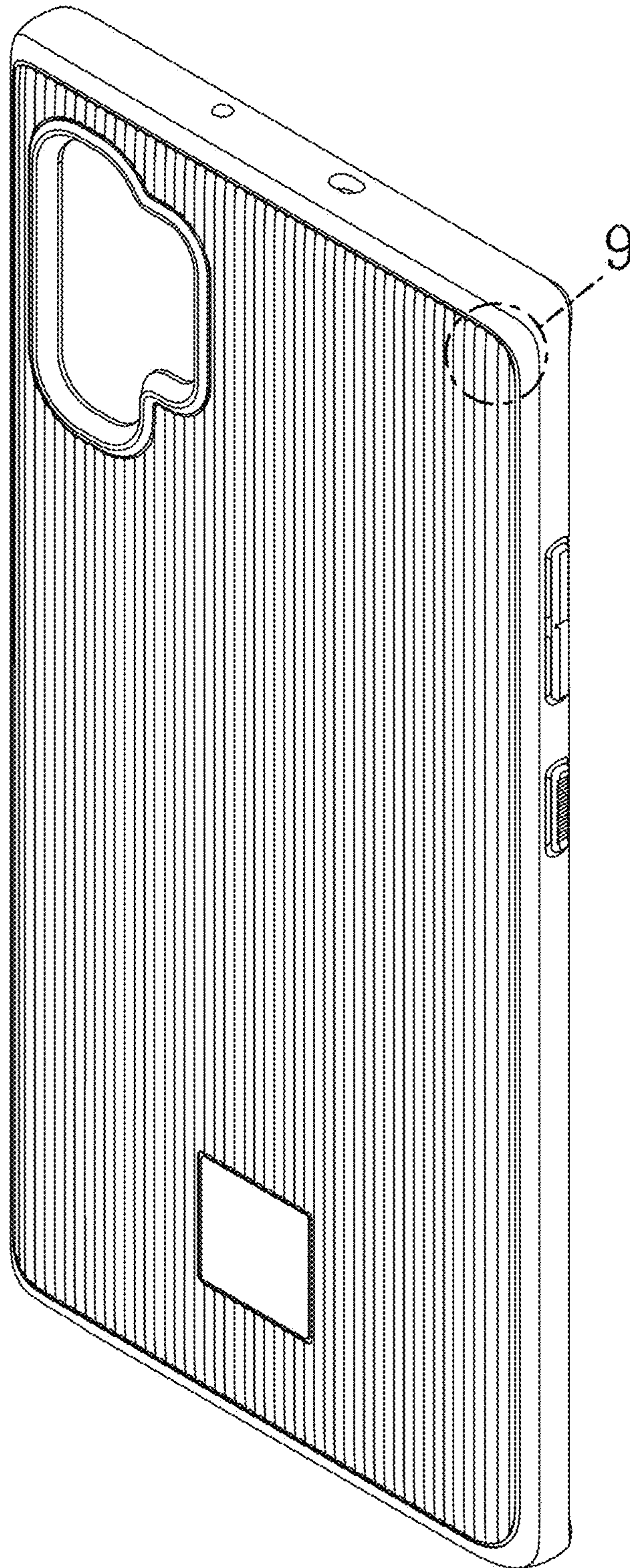

FIG. 3

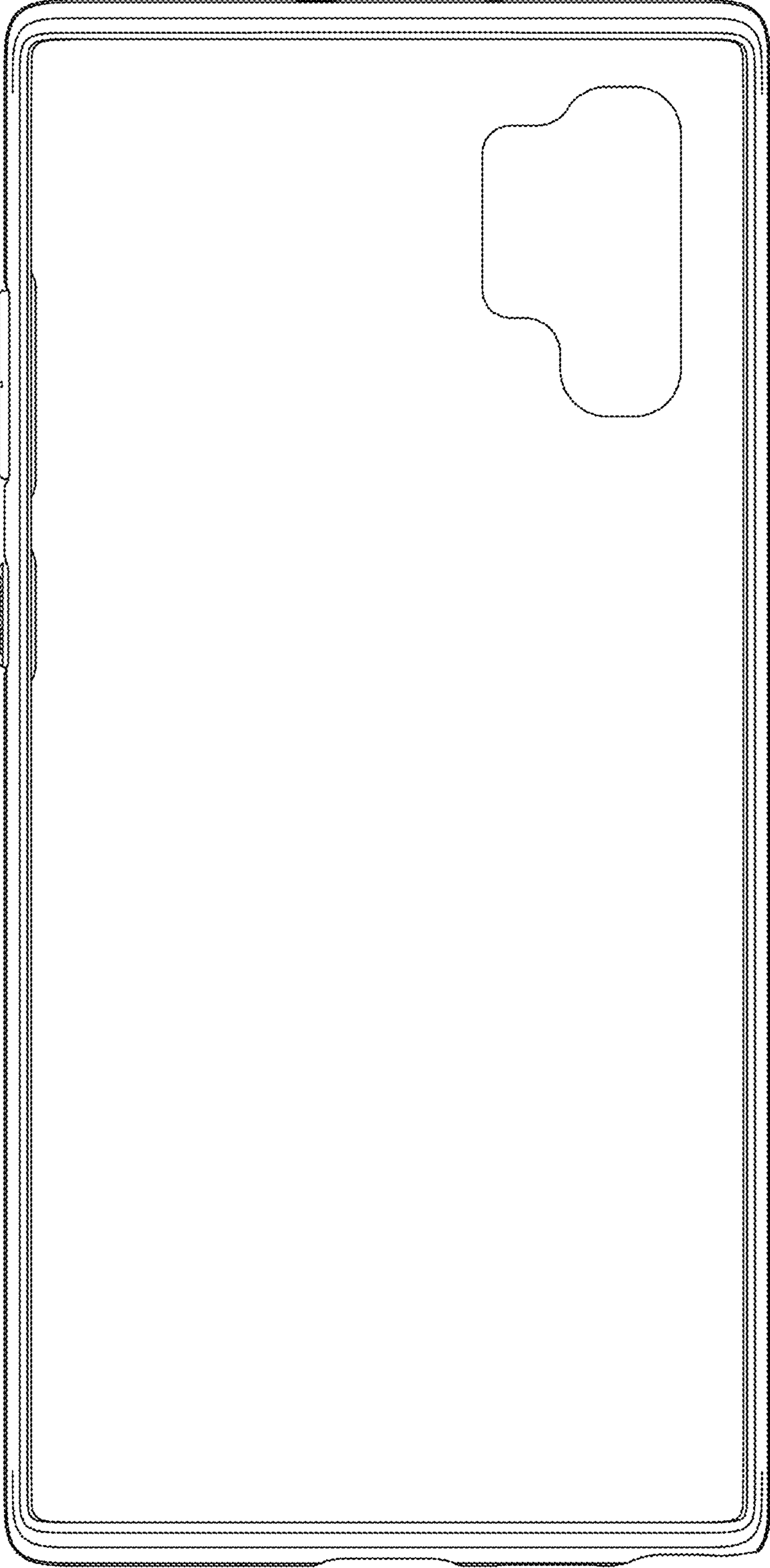

FIG. 4

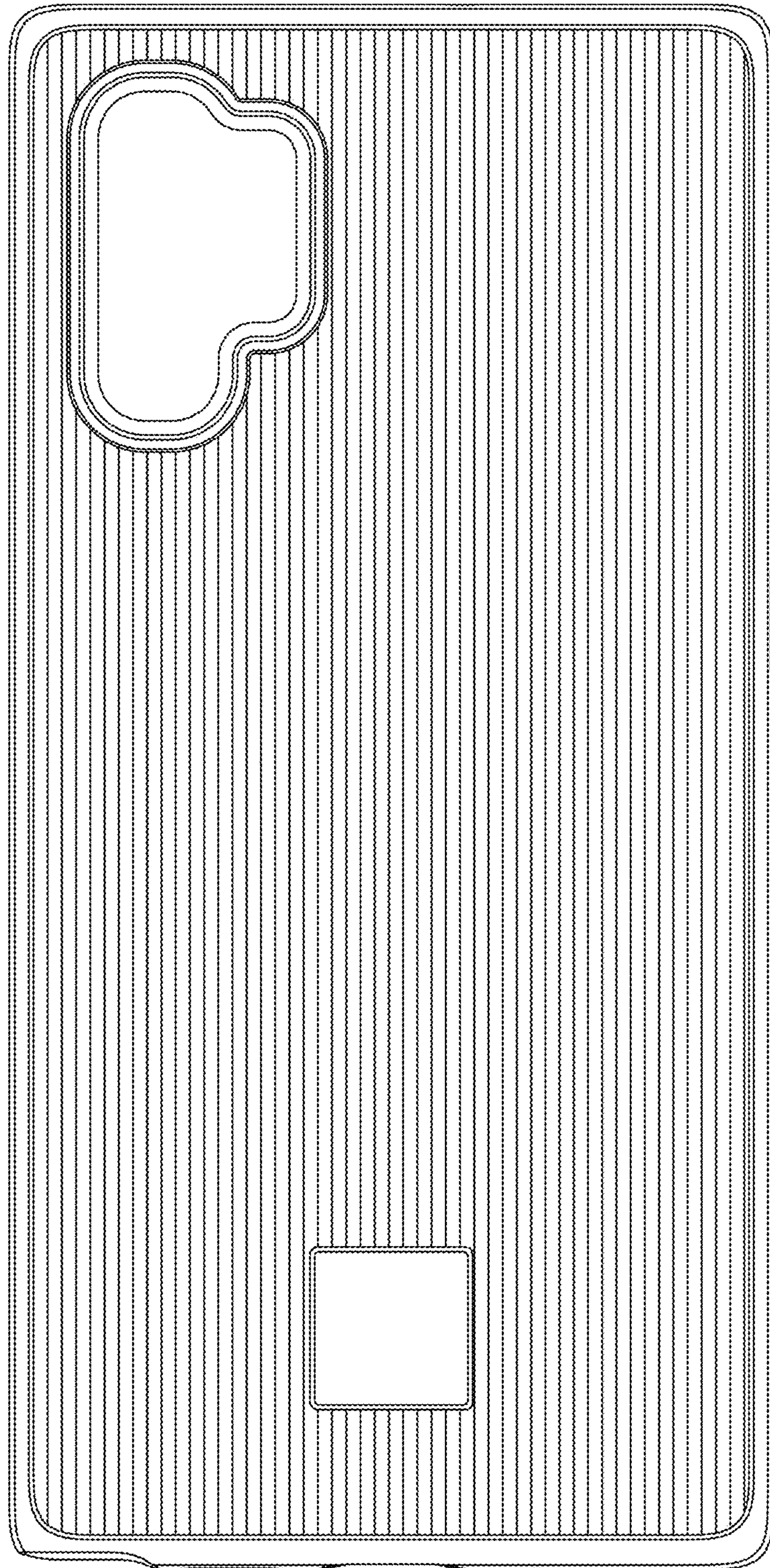

FIG. 5

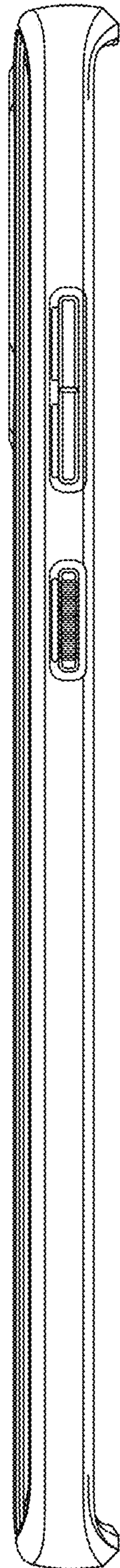

FIG. 6

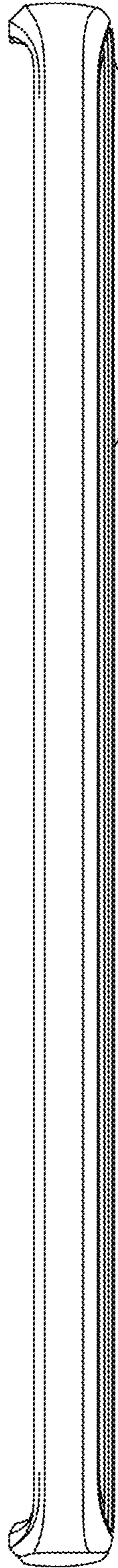

FIG. 7

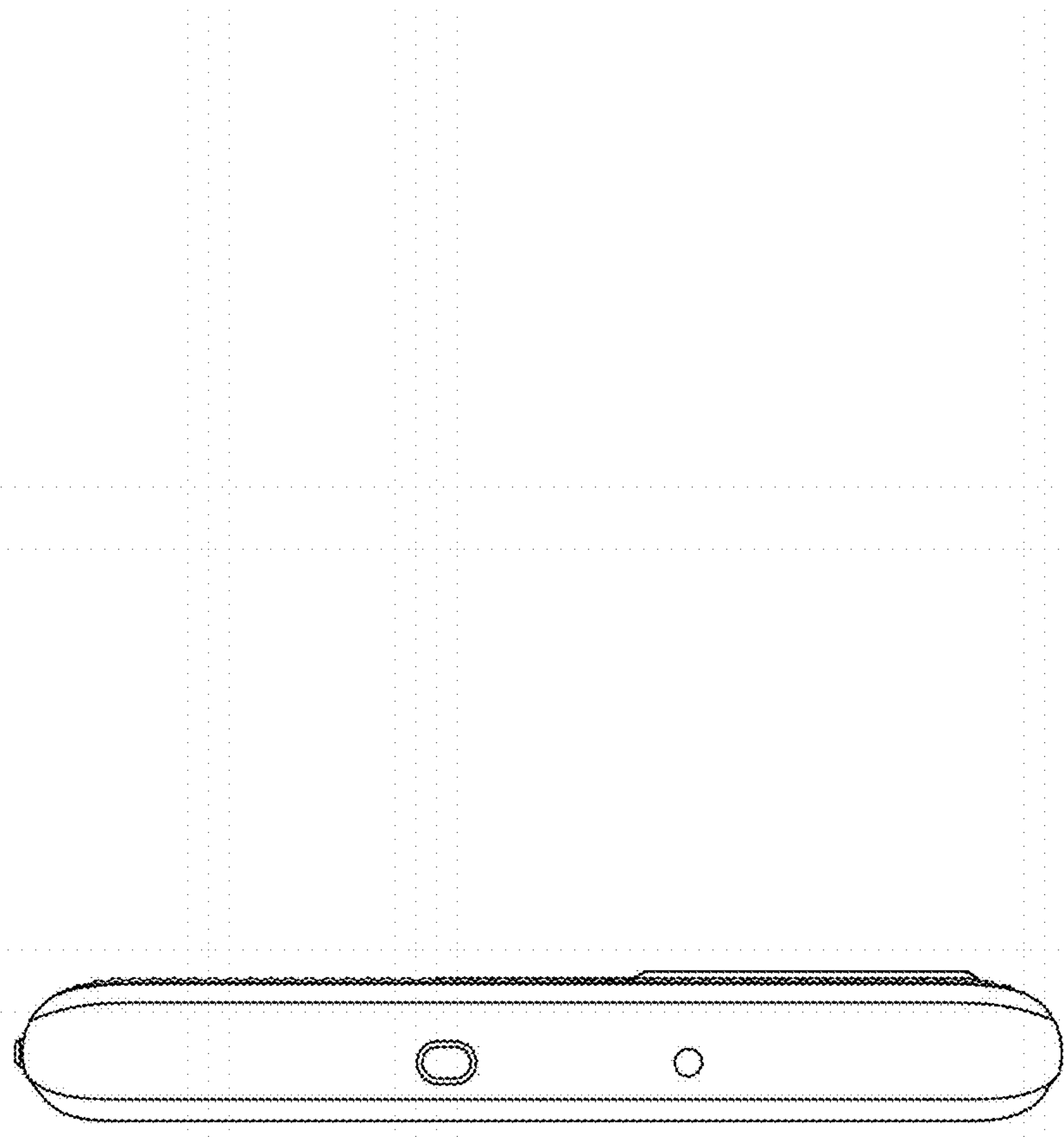

FIG. 8

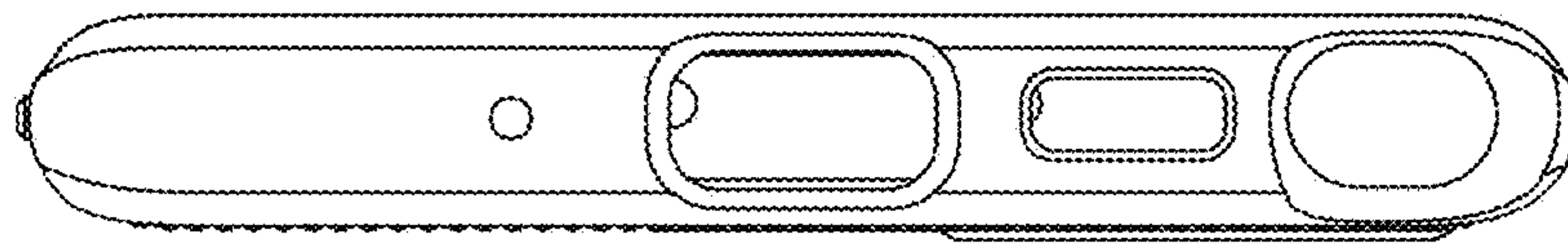

FIG. 9

