



US00D915379S

(12) **United States Design Patent** (10) **Patent No.:** **US D915,379 S**
Kim (45) **Date of Patent:** **** Apr. 6, 2021**

(54) **CASE FOR AN ELECTRONIC COMMUNICATIONS DEVICE**

(71) Applicant: **SPIGEN KOREA CO., LTD.**, Seoul (KR)

(72) Inventor: **Ji Hyun Kim**, Seoul (KR)

(73) Assignee: **SPIGEN KOREA CO., LTD.**, Seoul (KR)

(**) Term: **15 Years**

(21) Appl. No.: **29/700,731**

(22) Filed: **Aug. 5, 2019**

(51) **LOC (13) Cl.** **14-03**

(52) **U.S. Cl.**
USPC **D14/250**

(58) **Field of Classification Search**

USPC D14/440, 203.3–203.7, 439, 238.1, D14/251–253, 447, 217, 240, 248, 250; D3/201, 218, 247, 269, 273, 301, 303, D3/249; D13/103, 119, 107–108

CPC H04B 1/3888; H04M 1/0283; H04M 1/0202; A45C 1/06; A45C 11/00; A45C 13/02; A45C 2011/002; A45F 2005/026; A45F 2200/0525; A45F 2200/0516

See application file for complete search history.

(56) **References Cited**

U.S. PATENT DOCUMENTS

D606,305 S	*	12/2009	Lee	D3/269
D638,006 S		5/2011	Chang		
D648,332 S		11/2011	Kim et al.		
D654,491 S	*	2/2012	Melanson	D14/250
D663,297 S		7/2012	de Jong et al.		
D666,824 S	*	9/2012	Phillips	D3/303
D669,889 S		10/2012	Li et al.		
D679,692 S		4/2013	Fahrendorff et al.		

(Continued)

OTHER PUBLICATIONS

“Spigen Rugged Armor Moto E4 Case with Resilient Shock Absorption and Carbon Fiber Design for Moto E4 (2017)—Black”, <https://www.amazon.com/Spigen-Rugged-Armor-Designed-Motorola/dp/B073RVC6YY>, Earliest review date of Sep. 5, 2017, Downloaded on Jul. 17, 2018.

(Continued)

Primary Examiner — Carla J Wright

(74) *Attorney, Agent, or Firm* — Heedong Chae; Lucem, PC

(57) **CLAIM**

The ornamental design for a case for an electronic communications device, as shown and described.

DESCRIPTION

FIG. 1 is a front perspective view of a case for an electronic communications device showing my new design; FIG. 2 is a rear perspective view thereof; FIG. 3 is a front elevational view thereof; FIG. 4 is a rear elevational view thereof; FIG. 5 is a left side elevational view thereof; FIG. 6 is a right side elevational view thereof; FIG. 7 is a top plan view thereof; FIG. 8 is a bottom plan view thereof; and, FIG. 9 is an enlarged detail view of the encircled portion in FIG. 2.

The dashed broken line in FIG. 1 forms no part of the claimed design. Except for the interior regions immediately surrounding the openings and buttons that are bounded by solid lines, the interior surfaces of the case shown in FIGS. 1-3 also form no part of the claimed design. The dot-dash broken line circle in FIG. 2 delineates a portion of the case for an electronic communications device that is part of the claimed design and is shown on an enlarged scale in FIG. 9.

1 Claim, 9 Drawing Sheets

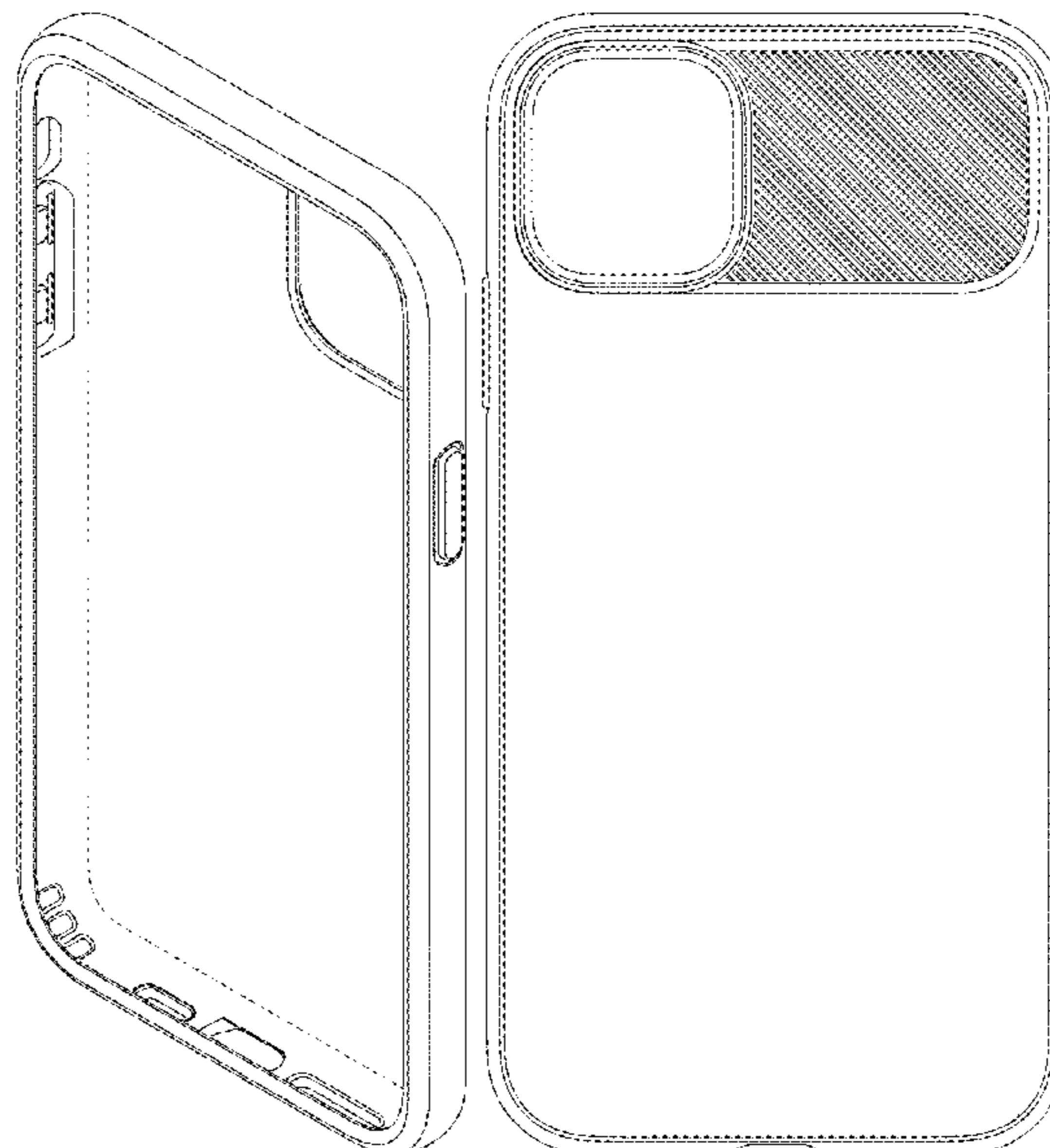

(56)

References Cited

U.S. PATENT DOCUMENTS

D681,617 S * 5/2013 Weller D14/250
 D683,340 S 5/2013 Chang et al.
 D687,796 S 8/2013 Lee
 D687,797 S 8/2013 Kim
 D691,601 S 10/2013 Murchison et al.
 D692,418 S 10/2013 Fahrenedorff et al.
 D692,419 S * 10/2013 Rayner D14/250
 D698,767 S 2/2014 Son
 D709,895 S * 7/2014 Son D14/440
 D716,283 S * 10/2014 Lee D14/250
 D716,783 S 11/2014 Loncar et al.
 D717,774 S 11/2014 Fathollahi
 D718,292 S 11/2014 Hemesath et al.
 D734,747 S 7/2015 Seo et al.
 D737,259 S 8/2015 Choi
 D739,394 S * 9/2015 Rayner D14/250
 D740,798 S 10/2015 Poon et al.
 D751,058 S * 3/2016 Cocchia D14/250
 D755,167 S 5/2016 Chen et al.
 D757,699 S * 5/2016 Lee D14/248
 D757,702 S 5/2016 Kanazawa
 D757,703 S 5/2016 Kanazawa
 D761,773 S * 7/2016 Choi D14/248
 D763,841 S 8/2016 Kim
 D765,638 S 9/2016 Gaylord et al.
 D781,838 S 3/2017 Kim et al.
 D782,453 S 3/2017 Kim et al.
 D785,613 S 5/2017 Lin et al.
 D786,853 S 5/2017 Friedland et al.
 D791,773 S 7/2017 Moore et al.
 D792,877 S * 7/2017 Kim D14/250
 D801,323 S 10/2017 Kim
 D807,868 S 1/2018 Wang
 D808,377 S 1/2018 Witter et al.
 D808,944 S 1/2018 Kim
 D812,600 S 3/2018 Altaras
 D812,618 S 3/2018 Altaras
 D812,619 S 3/2018 Altaras
 D813,215 S * 3/2018 Banerjee D14/248
 D816,651 S 5/2018 Chiang et al.
 D816,653 S 5/2018 Yu
 D820,820 S 6/2018 Ahn
 D824,377 S 6/2018 Kim et al.
 D827,627 S 9/2018 Lee
 D832,833 S * 11/2018 Kim D14/250
 D834,571 S 11/2018 Ravid
 D836,095 S 12/2018 Kim et al.
 D840,990 S 2/2019 Kim
 D840,991 S 2/2019 Kim
 D840,992 S 2/2019 Kim
 D841,011 S 2/2019 Mecchella et al.
 D845,290 S 4/2019 Brubaker et al.
 D847,806 S 5/2019 Kim
 D851,082 S 6/2019 Fitzgerald et al.
 D851,638 S 6/2019 Kim et al.
 D853,371 S * 7/2019 Wei D14/250
 D853,372 S * 7/2019 Kim D14/250
 10,362,847 B1 * 7/2019 Okada A45C 11/00
 D866,543 S * 11/2019 Kim D14/250
 D880,469 S * 4/2020 Lee D14/250
 2014/0221056 A1 * 8/2014 Gandhi H04B 1/3888
 455/575.8
 2017/0123217 A1 * 5/2017 Dukerschein G02B 30/37

OTHER PUBLICATIONS

“Spigen Rugged Armor Extra Designed for Apple iPhone 7 Case (2016)—Black”, <https://www.amazon.com/Spigen-Rugged-iPhone-Resilient-Absorption/dp/B06XC8WL7P>, Earliest review date of Sep. 17, 2017, downloaded on Jan. 9, 2020.
 “Spigen Rugged Armor Moto Z2 Force Case with Resilient Shock Absorption and Carbon Fiber Design for Moto Z2 Force (2017)—Black”, <https://www.amazon.com/Spigen-Rugged-Resilient-Absorption->

Carbon/dp/B074BCC6K7, Earliest review date of Sep. 23, 2017, downloaded on Jul. 17, 2018.
 “Spigen Rugged Armor Designed for Apple iPhone Xs Case (2018) / Designed for Apple iPhone X Case (2017)—Matte Black”, <https://www.amazon.com/Spigen-Rugged-Armor-Designed-iPhone/dp/B074CNF6YW>, Earliest review date of Sep. 28, 2017, Downloaded on Jan. 15, 2019.
 “Spigen Rugged Armor iPhone X Case with Resilient Shock Absorption and Carbon Fiber Design for Apple iPhone X (2017)—Matte Black”, <https://www.amazon.com/dp/B074CNF6YW>, Earliest review date of Sep. 28, 2017, Downloaded on Jul. 17, 2018.
 “Spigen Rugged Armor LG V30 with Resilient Shock Absorption and Carbon Fiber Design for LG V30 (2017)—Black”, <https://www.amazon.com/dp/B071JV1L9Z>, Earliest review date of Oct. 5, 2017, Downloaded on Jul. 17, 2018.
 “Spigen Rugged Armor Google Pixel 2 Case with Resilient Shock Absorption and Carbon Fiber Design for Google Pixel 2 (2017)—Black”, <https://www.amazon.com/Spigen-Rugged-Google-Resilient-Absorption/dp/B07471C38C>, Earliest review date of Oct. 10, 2017, Downloaded on Jan. 5, 2019.
 “Spigen Rugged Armor Google Pixel 2 Case with Resilient Shock Absorption and Carbon Fiber Design for Google Pixel 2 (2017)—Black”, <https://www.amazon.com/dp/B07471C38C>, Earliest review date of Oct. 10, 2017, Downloaded on Jul. 17, 2018.
 “Spigen Rugged Armor Google Pixel 2 XL Case with Resilient Shock Absorption and Carbon Fiber Design for Google Pixel 2 XL (2017)—Black”, <https://www.amazon.com/Spigen-Rugged-Google-Resilient-Absorption/dp/B07475TXJQ>, Earliest review date of Oct. 11, 2017, Downloaded on Jan. 5, 2019.
 “Caseology Vault for Apple iPhone 8 Case (2017)—Rugged Matte Finish—Black”, <https://www.amazon.com/Caseology-Vault-iPhone-Case-Rugged/dp/B075345DKH>, Earliest review date of Oct. 14, 2017, Downloaded on Jan. 16, 2020.
 “Caseology Vault for Google Pixel 2 XL Case (2017)—Rugged Matte Finish—Black”, <https://www.amazon.com/Caseology-Vault-Google-Pixel-Case/dp/B075RVL499>, Earliest review date of Oct. 14, 2017, Downloaded on Jul. 16, 2020.
 “Spigen Rugged Armor Moto X4 Case with Resilient Shock Absorption and Carbon Fiber Design for Moto X4—Black”, <https://www.amazon.com/dp/B072N3WT4J>, Earliest review date of Oct. 22, 2017, Downloaded on Jul. 17, 2018.
 “Spigen Rugged Armor Galaxy A8 (2016) Case with Resilient Shock Absorption and Carbon Fiber Design for Galaxy A8 (2016)—Black”, <https://www.amazon.com/dp/B01M26EX8X>, Earliest review date of Oct. 25, 2017, Downloaded on Jul. 17, 2018.
 “Caseology Vault for iPhone Xs Case (2018) / iPhone X Case (2017)—Rugged Matte Finish—Black”, <https://www.amazon.com/Caseology-Vault-iPhone-Xs-Case/dp/B07533BBZ4>, Earliest review date of Oct. 26, 2017, Downloaded on Jan. 16, 2020.
 “Spigen Rugged Armor ZTE Axon 7 Case with Resilient Shock Absorption and Carbon Fiber Design for ZTE Axon 7—Black”, <https://www.amazon.com/dp/B01LXS2BQW>, Earliest review date of Nov. 22, 2017, Downloaded on Jul. 18, 2018.
 “Spigen Rugged Armor Sony Xperia XZ1 Case with Resilient Shock Absorption and Carbon Fiber Design for Sony Kperia XZ1 (2017)—Black”, <https://www.amazon.com/dp/B075DRB8TX>, Earliest review date of Nov. 22, 2017, Downloaded on Jul. 18, 2018.
 “Caseology Nero Slim for Apple iPhone X Case (2017)—360 Protection—Black”, <https://www.amazon.com/Caseology-Nero-Slim-iPhone-Case/dp/B0752WXYM7>, Earliest review date of Dec. 17, 2017, Downloaded on Jan. 15, 2020.
 “Spigen Rugged Armor Huawei Honor 7X Case/Huawei Mate SE Case with Resilient Shock Absorption and Carbon Fiber Design for Huawei Honor 7X (2017)/Huawei Mate SE (2018)—Black”, <https://www.amazon.com/dp/B076V3D2F5>, Earliest review date of Dec. 19, 2017, Downloaded on Jul. 18, 2018.
 “Spigen Rugged Armor OnePlus 5T Case with Resilient Shock Absorption and Carbon Fiber Design for OnePlus 5T (2017)—Black”, <https://www.amazon.com/dp/B077H6RVD6>, Earliest review date of Dec. 25, 2017, Downloaded on Jul. 17, 2018.

(56)

References Cited

OTHER PUBLICATIONS

“Spigen Rugged Armor Honor 9 Case with Resilient Shock Absorption and Carbon Fiber Design for Honor 9—Black”, <https://www.amazon.com/dp/B071GPHBFF>, Earliest review date of Jan. 2, 2018, Downloaded on Jul. 18, 2018.

“Spigen Rugged Armor Galaxy J3 Prime case/Galaxy J3 Luna Pro case/Galaxy J3 Emerge Case with Resilient Shock Absorption and Carbon Fiber Design for Galaxy J3 Emerge/Galaxy J3/J3 2017—Black”, <https://www.amazon.com/dp/B0746RC5BJ>, Earliest review date of Jan. 5, 2018, Downloaded on Jul. 17, 2018.

“Spigen Rugged Armor Honor 5X Case with Resilient Shock Absorption and Carbon Fiber Design for Huawei Honor 5X—Black”, <https://www.amazon.com/dp/B01DJHHXD2>, Earliest review date of Jan. 22, 2018, Downloaded on Jul. 18, 2018.

“Spigen Rugged Armor Razer Phone Case with Flexible and Durable Shock Absorption with Carbon Fiber Design for Razer Phone (2017)—Black”, <https://www.amazon.com/dp/B078KJQH5V>, Earliest review date of Feb. 8, 2018, Downloaded on Jul. 17, 2018.

“Spigen Rugged Armor Galaxy S9 Case with Flexible and Durable Shock Absorption with Carbon Fiber Design for Samsung Galaxy S9 (2018)—Matte Black”, <https://www.amazon.com/dp/B078BJQMPG>, Earliest review date of Mar. 3, 2018, Downloaded on Jul. 17, 2018.

“Caseology Vault for Galaxy S9 Plus Case (2018)—Rugged Matte Finish—Burgundy”, <https://www.amazon.com/Caseology-Vault-Galaxy-Plus-Case/dp/B07995SB3C>, Earliest review date of Mar. 4, 2018, Downloaded on Jan. 16, 2020.

“Spigen Rugged Armor Galaxy S9 Plus Case with Flexible and Durable Shock Absorption with Carbon Fiber Design for Samsung Galaxy S9 Plus (2018)—Matte Black”, <https://www.amazon.com/dp/B0789S2MPW>, Earliest review date of Mar. 9, 2018, Downloaded on Jul. 17, 2018.

“Spigen Rugged Armor Mi A1 (Mi 5X Case with Flexible and Durable Shock Absorption with Carbon Fiber Design for Xiaomi Mi A1 /Mi SX (2017)—Black”, <https://www.amazon.com/dp/B078Z531CZ>, Earliest review date of Mar. 19, 2018, Downloaded on Jul. 18, 2018.

“Caseology Nero Slim for Apple iPhone 8 Plus Case (2017) / for iPhone 7 Plus Case (2016)—360 Protection—Black”, <https://www.amazon.com/Caseology-Nero-iPhone-Screen-Protector/dp/B075331GY5>, Earliest review date of Apr. 25, 2018, Downloaded on Jan. 15, 2020.

“Spigen Rugged Armor Designed for LG G7 ThinQ Case (2018)—Black”, <https://www.amazon.com/Spigen-Rugged-Armor-Designed-ThinQ/dp/B078MVT3GJ>, Earliest review date of Jun. 2, 2018, Downloaded on Jan. 15, 2019.

“Spigen Rugged Armor Moto G6 Case with Flexible and Durable Shock Absorption with Carbon Fiber Design for Motorola Moto G6 (2018)—Black”, <https://www.amazon.com/Spigen-Flexible-Durable-Absorption-Motorola/dp/B079LS3T4T>, Earliest review date of Jun. 11, 2018, Downloaded on Jan. 15, 2019.

“Spigen Rugged Armor OnePlus 6 Case with Flexible and Durable Shock Absorption with Carbon Fiber Design for OnePlus 6 (2018)—Black”, <https://www.amazon.com/dp/B07B9TC2WV>, Earliest review date of Jun. 22, 2018, Downloaded on Jul. 17, 2018.

“Spigen Rugged Armor Moto G5S Plus Case with Resilient Shock Absorption and Carbon Fiber Design for Moto G5S Plus—Black”, <https://www.amazon.com/dp/B0731QBBYY>, Earliest review date of Jul. 3, 2018, Downloaded on Jan. 15, 2019.

“Spigen Rugged Armor Design for Apple iPad 9.7 Case iPad Case (2017/2018)—Black”, <https://www.amazon.com/Spigen-Rugged-Armor-Design-Apple/dp/B07CTZS3KJ>, Earliest review date of Jul. 25, 2018, Downloaded on Jan. 15, 2019.

“Spigen Rugged Armor Galaxy S6 Case with Resilient Shock Absorption and Carbon Fiber Design for Galaxy S6 2015—Black”, <https://www.amazon.com/dp/B00T6P05ZK>, Earliest review date of Mar. 10, 2015, Downloaded on Jul. 17, 2018.

“Spigen Rugged Armor Galaxy S6 Edge Case with Flexible and Durable Shock Absorption with Carbon Fiber Design for Samsung

Galaxy S6 Edge (2015)—Black”, <https://www.amazon.com/dp/B00SVCITW0>, Earliest review date of Mar. 13, 2015, Downloaded on Jul. 17, 2018.

“Spigen Rugged Armor Galaxy Note 5 Case with Resilient Shock Absorption and Carbon Fiber Design for Galaxy Note 5 2015—Black”, <https://www.amazon.com/dp/B010MWFUBY>, Earliest review date of Aug. 23, 2015, Downloaded on Jul. 17, 2018.

“Spigen Rugged Armor iPhone 6S Case with Resilient Shock Absorption and Carbon Fiber Design for iPhone 6S/iPhone 6—Black”, <https://www.amazon.com/dp/B010MVJM5K>, Earliest review date of Sep. 3, 2015, Downloaded on Jul. 17, 2018.

“Spigen Rugged Armor iPhone 6S Plus Case with Resilient Shock Absorption and Carbon Fiber Design for iPhone 6S Plus 2015—Black”, <https://www.amazon.com/dp/B010MVR76Q>, Earliest review date of Sep. 7, 2015, Downloaded on Jul. 17, 2018.

“Spigen Tough Armor TECH iPhone 6S Case with Extreme Shock and Drop Protection for Apple iPhone 6 / 6S—Gunmetal”, <https://www.amazon.com/Spigen-Tough-iPhone-Extreme-Protection/dp/B013TKNSIS>, Earliest review date of Oct. 3, 2015, Downloaded on Jan. 15, 2019.

“Spigen Rugged Armor Samsung Galaxy S7 Case with Resilient Shock Absorption and Carbon Fiber Design for Samsung Galaxy S7 2016—Black”, <https://www.amazon.com/Spigen-Rugged-Designed-Samsung-Galaxy/dp/B01A7ICWTQ>, Earliest review date of Feb. 25, 2016, Downloaded on Jul. 17, 2018.

“Spigen Rugged Armor Galaxy S7 Edge Case with Flexible and Durable Shock Absorption with Carbon Fiber Design for Samsung Galaxy S7 Edge (2016)—Black”, <https://www.amazon.com/Spigen-Rugged-Designed-Samsung-Galaxy/dp/B01A7IDHOU>, Earliest review date of Feb. 28, 2016, Downloaded on Jul. 17, 2018.

“Spigen Rugged Armor Galaxy A5 Case with Resilient Shock Absorption and Carbon Fiber Design for Galaxy A5—Black”, <https://www.amazon.com/Spigen-Rugged-Designed-Samsung-Galaxy/dp/B018J07A46>, Earliest review date of Mar. 18, 2016, Downloaded on Jul. 17, 2018.

“Spigen Rugged Armor iPhone SE Case with Resilient Shock Absorption and Carbon Fiber Design for iPhone SE 2016—Black”, <https://www.amazon.com/Spigen-Rugged-iPhone-Resilient-Absorption/dp/B01BEDNUDK>, Earliest review date of Apr. 10, 2016, Downloaded on Jan. 15, 2019.

“Spigen Rugged Armor Honor 5X Case with Resilient Shock Absorption and Carbon Fiber Design for Huawei Honor 5X—Black”, <https://www.amazon.com/Spigen-Rugged-Resilient-Absorption-Carbon/dp/B01DJHHXD2>, Earliest review date of May 1, 2016, Downloaded on Jan. 15, 2019.

“Spigen Rugged Armor HTC 10 Case with Resilient Shock Absorption and Carbon Fiber Design for HTC 10 2016—Black”, <https://www.amazon.com/dp/B01DAN1T4E>, Earliest review date of May 4, 2016, Downloaded on Jul. 18, 2018.

“Spigen Rugged Armor OnePlus 3 Case/OnePlus 3T Case with Resilient Shock Absorption and Carbon Fiber Design for OnePlus 3 2016—Black”, <https://www.amazon.com/dp/B01H3PEWDK>, Earliest review date of Jul. 28, 2016, Downloaded on Jul. 17, 2018.

“Spigen Rugged Armor iPhone 8 Case / iPhone 7 Case with Resilient Shock Absorption and Carbon Fiber Design for Apple iPhone 8 (2017) / iPhone 7 (2016)—Black”, <https://www.amazon.co.uk/Spigen-Rugged-iPhone-Resilient-Absorption/dp/B01GIVX7TA>, Earliest review date of Aug. 2, 2016, downloaded on Oct. 24, 2018.

“Spigen Rugged Armor iPhone 8 Plus/iPhone 7 Plus Case with Resilient Shock Absorption and Carbon Fiber Design for Apple iPhone 8 Plus (2017)/iPhone 7 Plus (2016)—Black”, <https://www.amazon.com/dp/B01GIWGAAC>, Earliest review date of Sep. 2, 2016, Downloaded on Jul. 17, 2018.

“Spigen Rugged Armor Huawei P9 Lite Case with Resilient Shock Absorption and Carbon Fiber Design for Huawei P9 Lite—Black”, <https://www.amazon.com/B01DL0DJGM>, Earliest review date of Sep. 6, 2016, Downloaded on Jul. 18, 2018.

“Caseology Vault for Apple iPhone 8 Case (2017) / for iPhone 7 Case (2016)—Rugged & Flexible—Matte Black”, <https://www.amazon.com/dp/B01JSZOJ7M>, Earliest review date of Sep. 10, 2016, Downloaded on Jan. 16, 2020.

(56)

References Cited

OTHER PUBLICATIONS

“Spigen Rugged Armor iPhone 8 Case/iPhone 7 Case with Resilient Shock Absorption and Carbon Fiber Design for Apple iPhone 8 (2017)/iPhone 7 (2016)—Black”, <https://www.amazon.com/dp/B01GIVX7TA>, Earliest review date of Sep. 11, 2016, Downloaded on Jul. 17, 2018.

“The best iPhone 7 & 7 Plus cases available now”, <https://9to5mac.com/2016/09/07/best-iphone-7-7-plus-cases-accessories-available-now/>, Earliest review date of Sep. 17, 2016, Downloaded on Mar. 18, 2020.

“Spigen Rugged Armor Google Pixel XL Case with Resilient Shock Absorption and Carbon Fiber Design for Google Pixel XL 2016—Black”, <https://www.amazon.com/dp/B01M1EEXWJ>, Earliest review date of Oct. 2, 2016, Downloaded on Jul. 17, 2018.

“Spigen Rugged Armor LG V20 Case with Resilient Shock Absorption and Carbon Fiber Design for LG V20 2016—Black”, <https://www.amazon.com/dp/B01M0NW9P4>, Earliest review date of Oct. 19, 2016, Downloaded on Jul. 18, 2018.

“Spigen Rugged Armor Honor 8 Case with Resilient Shock Absorption for Huawei Honor 8 2016—Black”, <https://www.amazon.com/dp/B01LXTROW1>, Earliest review date of Oct. 20, 2016, Downloaded on Jul. 18, 2018.

“Caseology Vault for Google Pixel Case (2016)—Rugged & Flexible—Black”, <https://www.amazon.com/dp/B01MEDIMGS>, Earliest review date of Nov. 10, 2016, Downloaded on Jan. 16, 2020.

“Spigen Rugged Armor Moto Z Droid Case with Resilient Shock Absorption and Carbon Fiber Design for Moto Z Droid 2016—Black”, <https://www.amazon.com/dp/B01HCAQMBQ>, Earliest review date of Dec. 9, 2016, Downloaded on Jul. 17, 2018.

“Caseology Vault for Apple iPhone 7 Plus Case (2016)—Rugged Matte Finish—Black”, <https://www.amazon.com/dp/B01N2OCQV4>, Earliest review date of Dec. 16, 2016, Downloaded on Jan. 16, 2020.

“Spigen Rugged Armor Galaxy A3 2016 Case with Resilient Shock Absorption and Carbon Fiber Design for Galaxy A3 2016—Black”, <https://www.amazon.com/Spigen-Rugged-Armor-Samsung-Galaxy/dp/B01HFMYLIC>, Earliest review date of Dec. 18, 2016, Downloaded on Jul. 17, 2018.

“Spigen Rugged Armor ZenFone 3 Max Case (ZC520TL) with Resilient Shock Absorption and Carbon Fiber Design for ASUS ZenFone 3 Max (ZC520TL)—Black”, <https://www.amazon.com/dp/B01MSDJQ7C>, Earliest review date of Mar. 9, 2017, Downloaded on Jul. 18, 2018.

“Caseology Vault for LG G6 Case (2017)—Rugged Matte Finish—Black”, <https://www.amazon.com/dp/B06W52JLH>, Earliest review date of Mar. 28, 2017, Downloaded on Jan. 16, 2020.

“Spigen Rugged Armor Extra Designed for LG G6 Case (2017) / Designed for LG G6 Plus (2017)—Black”, <https://www.amazon.com/Spigen-Rugged-Resilient-Absorption-Carbon/dp/B01N6T9PHS>, Earliest review date of Mar. 28, 2017, Downloaded on Jan. 9, 2020.

“Spigen Rugged Armor LG G6 Case/G6 Plus Case with Resilient Shock Absorption and Carbon Fiber Design for LG G6/G6 Plus (2017)—Black”, <https://www.amazon.com/dp/B01MUCZILA>, Earliest review date of Mar. 30, 2017, Downloaded on Jul. 18, 2018.

“Caseology Vault for Samsung Galaxy S7 Case (2016)—Black”, <https://www.amazon.com/Caseology-Vault-Galaxy-S7-Case/dp/B019PBJIT8>, Earliest review date of Mar. 9, 2016, Downloaded on Jan. 16, 2020.

“Spigen Rugged Armor Galaxy S8 Plus Case with Resilient Shock Absorption and Carbon Fiber Design for Galaxy S8 Plus (2017)—Black”, <https://www.amazon.com/Spigen-Rugged-Designed-Samsung-Galaxy/dp/B06XNW4ZVJ>, Earliest review date of Apr. 3, 2017, Downloaded on Jul. 17, 2018.

“Caseology Vault for Samsung Galaxy S8 Plus Case (2017)—Black”, <https://www.amazon.com/Caseology-Vault-Galaxy-Plus-Case/dp/B06XJB79BM>, Earliest review date of Apr. 3, 2017, Downloaded on Jan. 16, 2020.

“Spigen Rugged Armor Galaxy S8 Case with Resilient Shock Absorption and Carbon Fiber Design for Samsung Galaxy S8

(2017)—Black”, <https://www.amazon.com/Spigen-Rugged-Designed-Samsung-Galaxy/dp/B06XNNJ4KM>, Earliest review date of Apr. 7, 2017, Downloaded on Jul. 17, 2018.

“Caseology Vault I for Samsung Galaxy S8 Case (2017)—Black”, <https://www.amazon.com/Caseology-Vault-Galaxy-Case-Simplistic/dp/B06XJDMFK3>, Earliest review date of Apr. 20, 2017, Downloaded on Jan. 16, 2020.

Spigen, “Spigen Rugged Armor Extra”, <https://www.youtube.com/watch?v=ILUEjn1P2hk>, Published on May 26, 2017, Downloaded on Jan. 9, 2020.

“Spigen Rugged Armor Huawei P10 Plus Case with Resilient Shock Absorption and Carbon Fiber Design for Huawei P10 Plus(2017)—Rugged Armor”, <https://www.amazon.com/dp/B06XFZW779>, Earliest review date of May 26, 2017, Downloaded on Jul. 18, 2018.

“Spigen Rugged Armor Galaxy J7 2017 Case, J7 Prime, J7 2017(At &T), J7 Sky Pro, J7 Perx case with Resilient Shock Absorption and Carbon Fiber Design for Samsung Galaxy J7 V 2017—Black”, <https://www.amazon.com/Spigen-Rugged-Resilient-Absorption-Samsung/dp/B06WRRF36B>, Earliest review date of May 31, 2017, Downloaded on Jan. 15, 2019.

“Spigen Rugged Armor Huawei P10 Lite Case with Resilient Shock Absorption and Carbon Fiber Design for Huawei P10 Lite (2017)—Black”, <https://www.amazon.com/dp/B06XCNQ3S4>, Earliest review date of Jun. 7, 2017, Downloaded on Jul. 18, 2018.

“Spigen Rugged Armor Huawei P10 Case with Resilient Shock Absorption and Carbon Fiber Design for Huawei P10 (2017)—Black”, <https://www.amazon.com/dp/B06XCTQR1W>, Earliest review date of Jun. 8, 2017, Downloaded on Jul. 18, 2018.

“Spigen Rugged Armor HTC U11 Case with Resilient Shock Absorption and Carbon Fiber Design for HTC U 11 (2017)—Black”, <https://www.amazon.com/dp/B07234FLGX>, Earliest review date of Jun. 17, 2017, Downloaded on Jul. 18, 2018.

“Spigen Rugged Armor Huawei P8 Lite 2017 Case with Resilient Shock Absorption and Carbon Fiber Design for Huawei P8 Lite (2017)/nova lite/P9 lite 2017/Honor 8 lite—Black”, <https://www.amazon.com/dp/B06XFVXMLN>, Earliest review date of Jun. 24, 2017, Downloaded on Jul. 18, 2018.

“Spigen Rugged Armor Extra Galaxy Temp Case with Resilient Shock Absorption and Carbon Fiber Design for Galaxy Temp (2017)—Black”, <https://www.amazon.com/Spigen-Rugged-Galaxy-Resilient-Absorption/dp/B01MTEQVNB>, Earliest review date of Jul. 6, 2017, Downloaded on Jan. 9, 2020.

“Spigen Rugged Armor Sony Xperia XZ Premium Case with Resilient Shock Absorption and Carbon Fiber Design for Sony Xperia XZ Premium (2017)—Black”, <https://www.amazon.com/dp/B072PRXPQC>, Earliest review date of Jul. 14, 2017, Downloaded on Jul. 18, 2018.

“Spigen Rugged Armor OnePlus 5 Case with Resilient Shock Absorption and Carbon Fiber Design for OnePlus 5 (2017)—Black”, <https://www.amazon.com/dp/B06XG19W3G>, Earliest review date of Jul. 25, 2017, Downloaded on Jul. 17, 2018.

“Spigen Rugged Armor Moto Z2 Play Case with Resilient Shock Absorption and Carbon Fiber Design for Moto Z2 Play—Black”, <https://www.amazon.com/dp/B071WR4H9V>, Earliest review date of Jul. 27, 2017, Downloaded on Jul. 17, 2018.

“Caseology Nero Tough for iPhone 8 Plus Case (2017) / iPhone 7 Plus Case (2016)—360 Protection—Black”, <https://www.amazon.com/dp/B07534JMM2>, Earliest review date of Aug. 23, 2017, Downloaded on Nov. 19, 2019.

“Spigen Rugged Armor Galaxy Note 8 Case with Resilient Shock Absorption and Carbon Fiber Design for Galaxy Note 8 (2017)—Matte Black”, <https://www.amazon.com/Spigen-Rugged-Galaxy-Resilient-Absorption/dp/B073RWJ6Z7>, Earliest review date of Aug. 26, 2017, Downloaded on Jan. 15, 2019.

“Caseology Vault for Samsung Galaxy Note 8 Case (2017)—Black”, <https://www.amazon.com/Caseology-Vault-Galaxy-Note-Case/dp/B074NGCSX8>, Earliest review date of Aug. 31, 2017, Downloaded on Jan. 16, 2020.

“Spigen Rugged Armor Huawei P8 Lite Case with Resilient Shock Absorption and Carbon Fiber Design for Huawei P8 Lite (2015)—

(56)

References Cited

OTHER PUBLICATIONS

Black”, <https://www.amazon.com/dp/B01DL0DME6>, Earliest review date of Jun. 1, 2016, downloaded on Jul. 18, 2018.

* cited by examiner

FIG. 1

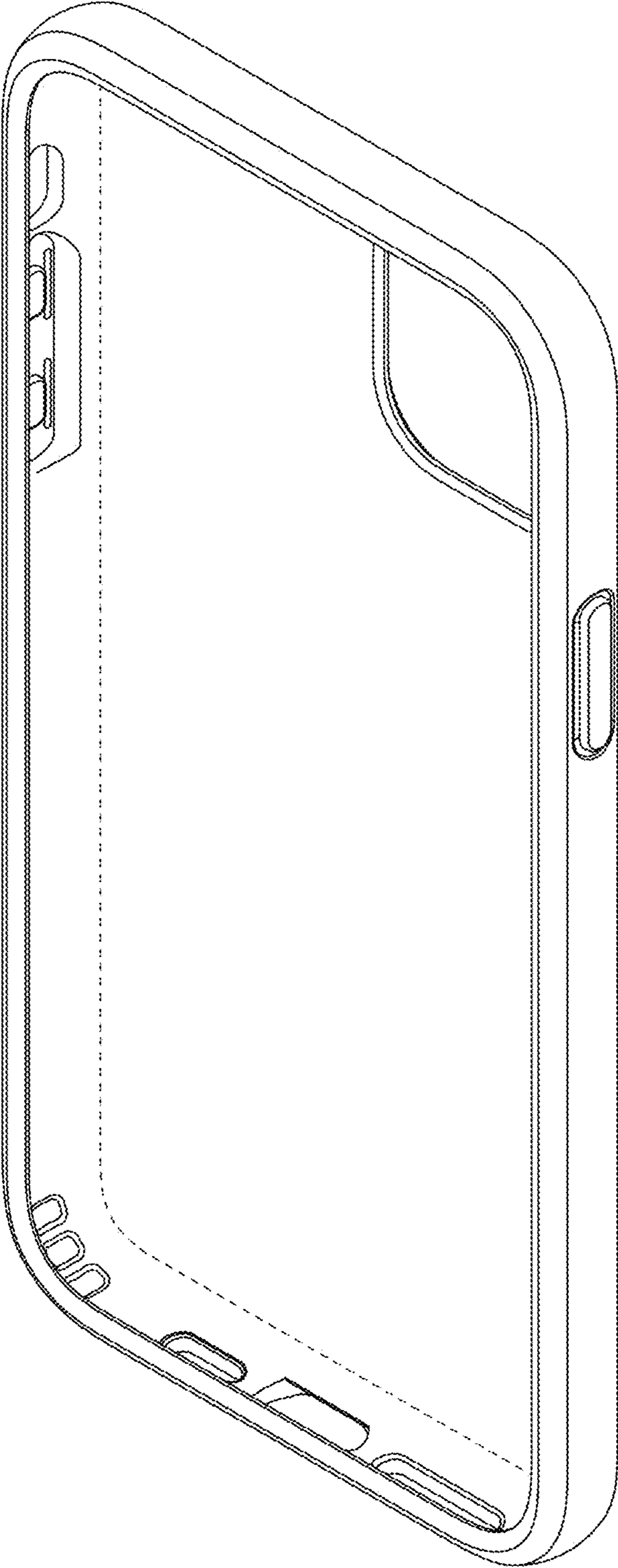

FIG. 2

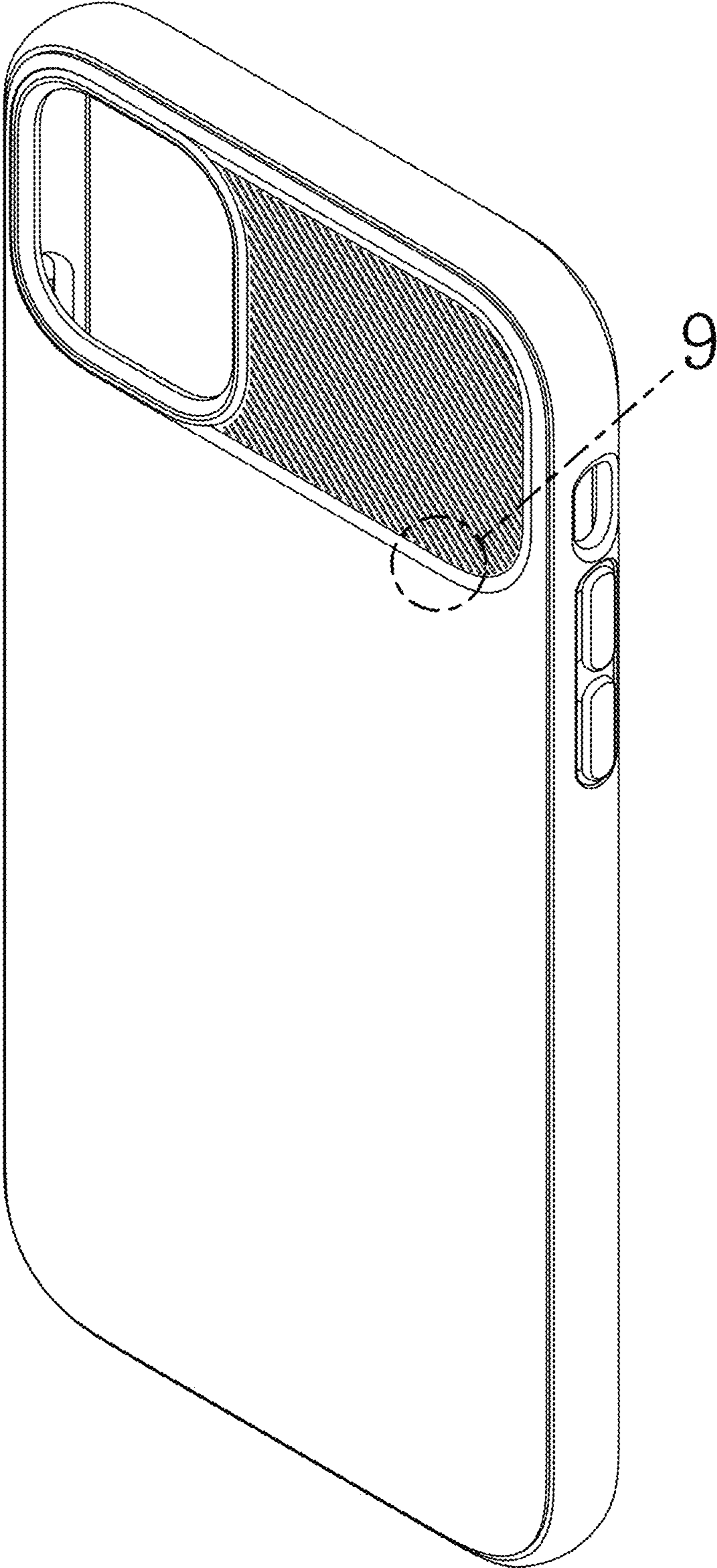

FIG. 3

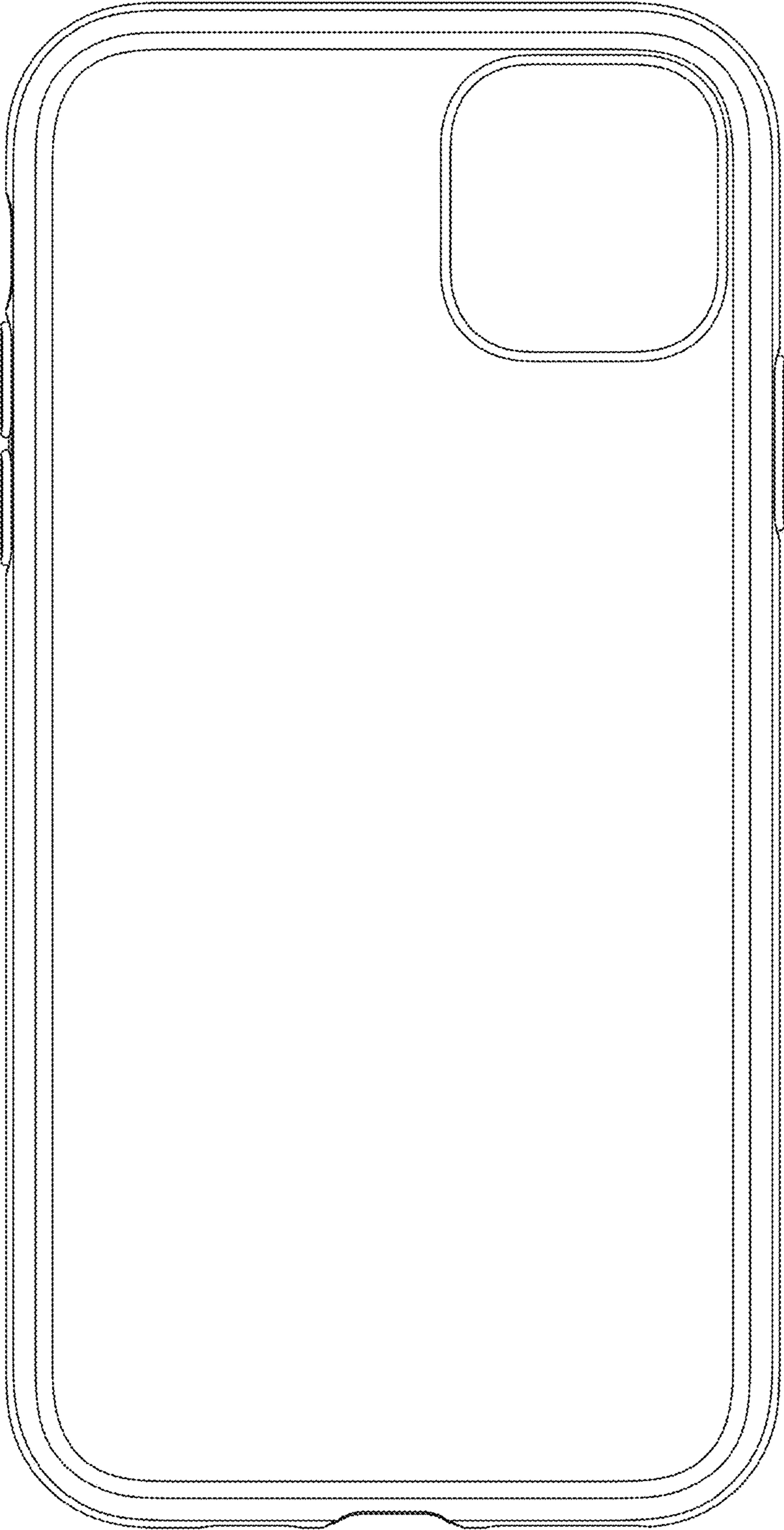

FIG. 4

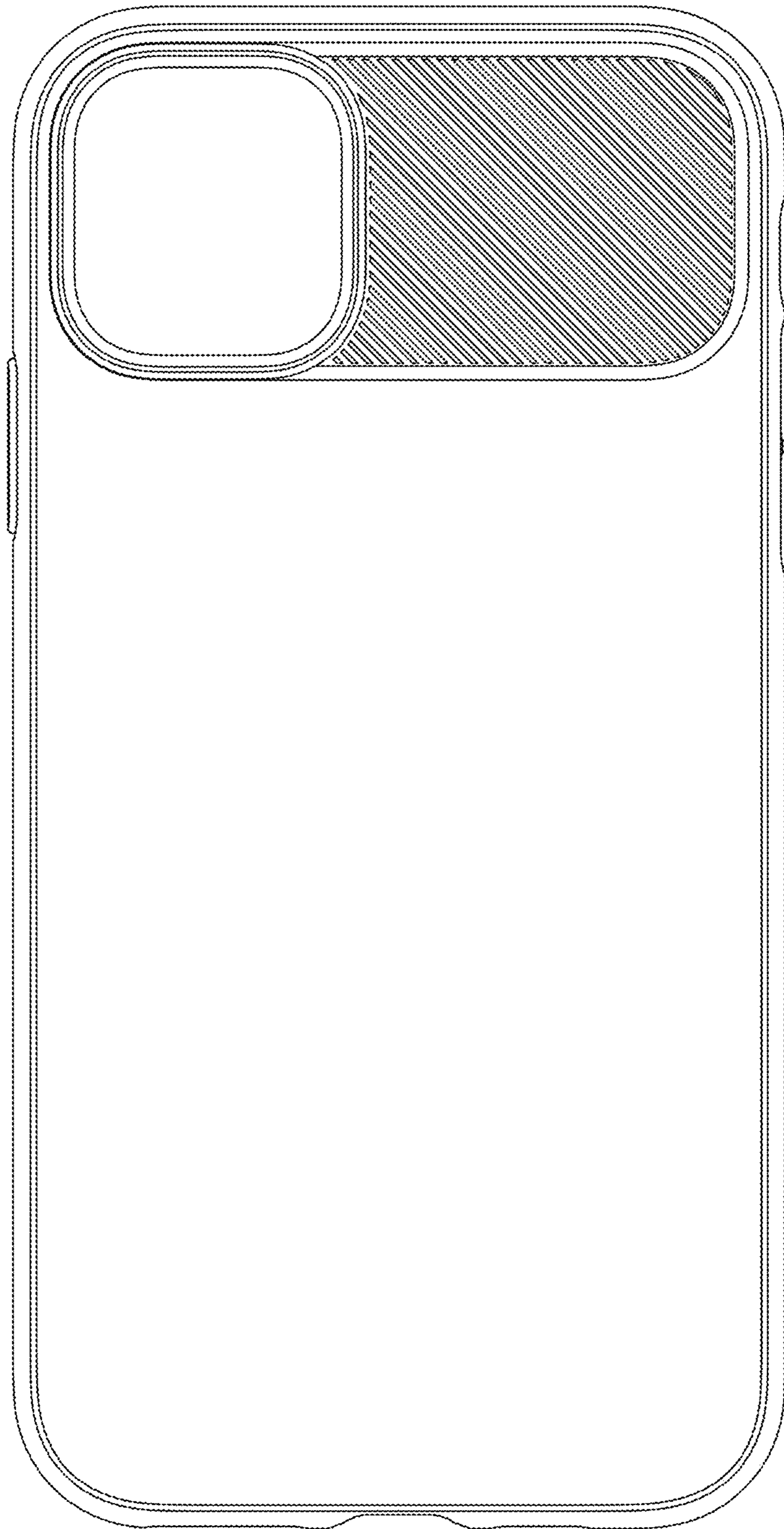

FIG. 5

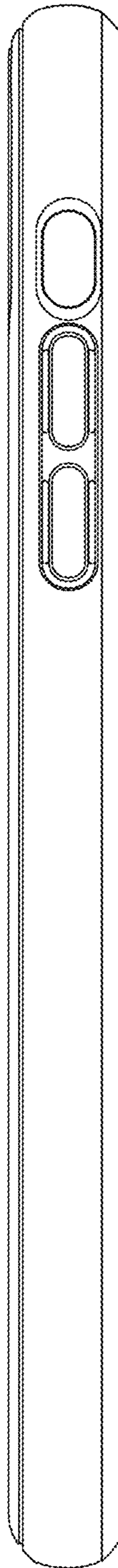

FIG. 6

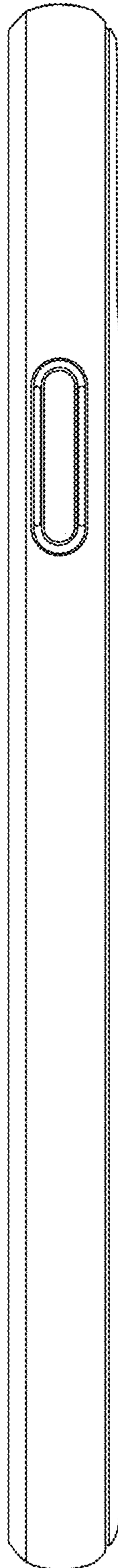

FIG. 7

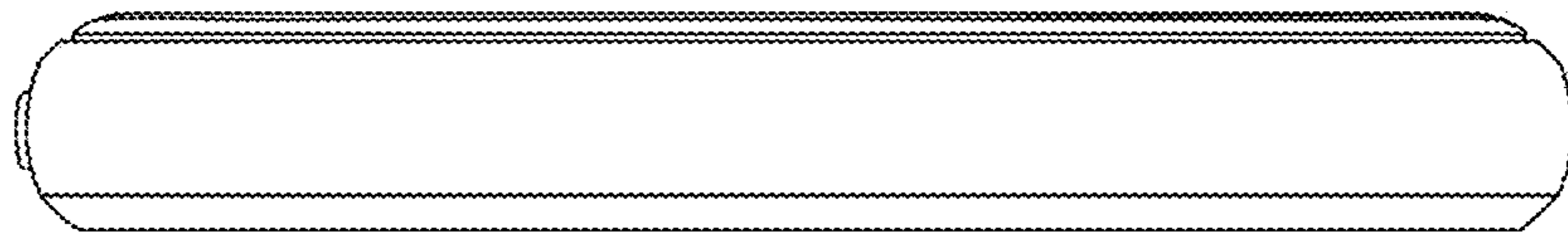

FIG. 8

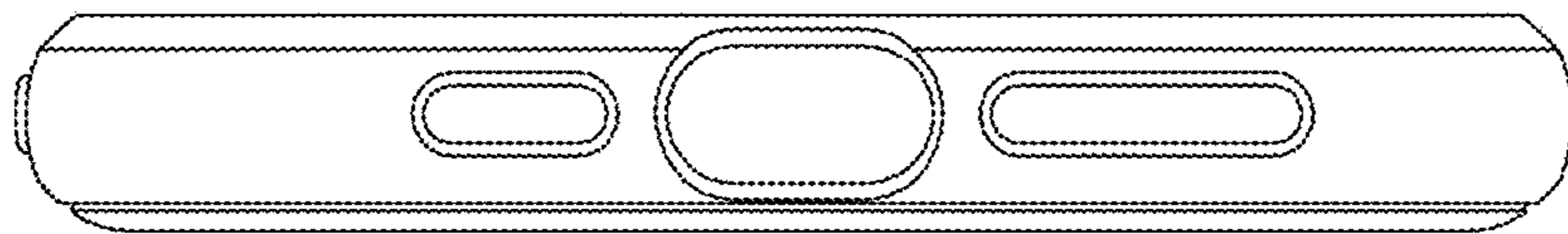

FIG. 9

