



US00D915355S

(12) **United States Design Patent**  
**Xiang**

(10) **Patent No.:** **US D915,355 S**

(45) **Date of Patent:** **\*\* Apr. 6, 2021**

(54) **EARPHONE**

(71) Applicant: **Realme Mobile Telecommunications (Shenzhen) Co., Ltd., Shenzhen (CN)**

(72) Inventor: **Hai Xiang, Guangdong (CN)**

(73) Assignee: **Realme Mobile Telecommunications (Shenzhen) Co., Ltd., Shenzhen (CN)**

(\*\*) Term: **15 Years**

(21) Appl. No.: **29/725,056**

(22) Filed: **Feb. 21, 2020**

(30) **Foreign Application Priority Data**

Aug. 28, 2019 (CN) ..... 201930471818.5

(51) **LOC (13) Cl.** ..... **14-01**

(52) **U.S. Cl.**  
USPC ..... **D14/223**

(58) **Field of Classification Search**  
USPC ... D14/205, 207, 217, 221, 223, 224, 224.1, D14/225; D24/173, 174  
CPC ..... H04R 1/10; H04R 1/1016; H04R 1/1066; H04R 1/105; H04R 1/1033; H04R 1/08; H04R 5/033; H04R 5/0335; H04R 25/00  
See application file for complete search history.

(56) **References Cited**

**U.S. PATENT DOCUMENTS**

D681,015 S *	4/2013	Akana .....	H04R 1/10 D14/223
D801,314 S *	10/2017	Akana .....	D14/223
D830,345 S *	10/2018	Cai .....	D14/223
D847,125 S *	4/2019	Akana .....	D14/223
D853,995 S *	7/2019	Cai .....	D14/223
D869,445 S *	12/2019	Hu .....	D14/223
D878,337 S *	3/2020	Yang .....	D14/223
D883,960 S *	5/2020	Du .....	D14/223
D885,373 S *	5/2020	Lundback .....	D14/223
D888,690 S *	6/2020	Yan .....	D14/223

D889,437 S *	7/2020	Ando .....	D14/223
D889,439 S *	7/2020	Hsieh .....	D14/223
D889,440 S *	7/2020	Yan .....	D14/223
D890,138 S *	7/2020	Peng .....	D14/223
D890,724 S *	7/2020	Li .....	D14/223
D895,579 S *	9/2020	Yang .....	D14/223
D895,582 S *	9/2020	Wu .....	D14/223

(Continued)

**FOREIGN PATENT DOCUMENTS**

CN 201930471818.5 \* 8/2019

**OTHER PUBLICATIONS**

Realme Buds Air: All We Know About Realme's Truly Wireless Earbuds So Far, announced Dec. 2020 [online], retrieved Jan. 27, 2021, retrieved from internet, <https://in.mashable.com/tech/9246/realme-buds-air-all-we-know-about-realme-truly-wireless-earbuds-so-far> (Year: 2020).\*

(Continued)

*Primary Examiner* — Dana K Weiland  
*Assistant Examiner* — Messina L Smith

(57) **CLAIM**

The ornamental design for an earphone, as shown and described.

**DESCRIPTION**

FIG. 1 is a front, left perspective view of an earphone showing our new design;  
FIG. 2 is a front view thereof;  
FIG. 3 is a rear view thereof;  
FIG. 4 is a left side view thereof;  
FIG. 5 is a right side view thereof;  
FIG. 6 is a top view thereof; and,  
FIG. 7 is a bottom view thereof.  
The broken lines in the figures show portions of the earphone that form no part of the claimed design.

**1 Claim, 7 Drawing Sheets**

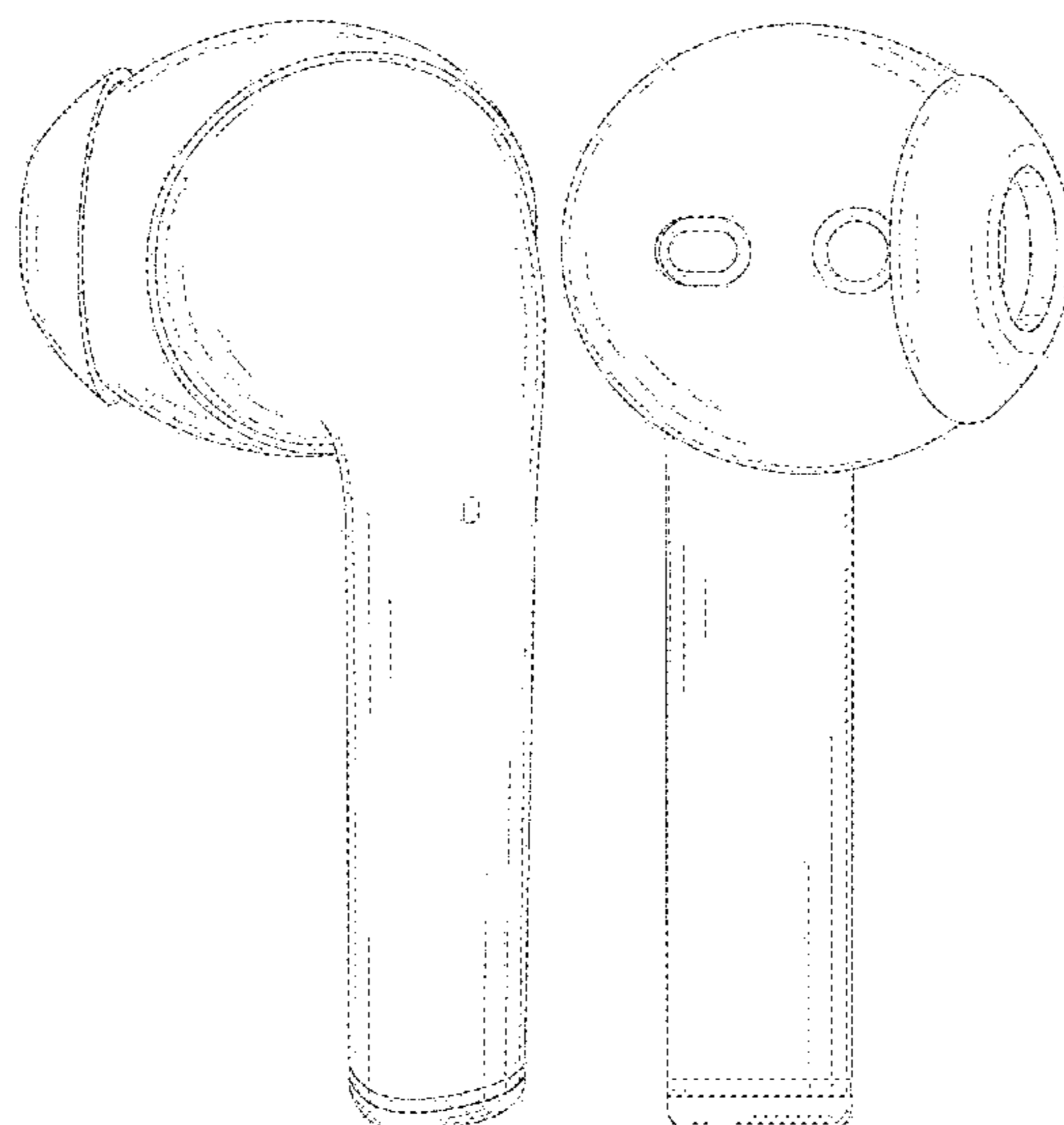

(56)

**References Cited**

U.S. PATENT DOCUMENTS

D896,206	S	*	9/2020	Xu	.....	D14/223
D896,788	S	*	9/2020	Akana	.....	D14/223
D901,457	S	*	11/2020	Zhang	.....	D14/223
D903,639	S	*	12/2020	Yang	.....	D14/223
D904,351	S	*	12/2020	Zhang	.....	D14/223
D905,017	S	*	12/2020	Chen	.....	D14/223
D905,019	S	*	12/2020	Liu	.....	D14/223
D905,020	S	*	12/2020	Du	.....	D14/223
D906,297	S	*	12/2020	Akana	.....	D14/223
D907,010	S	*	1/2021	Akana	.....	D14/223
D907,011	S	*	1/2021	Liu	.....	D14/223
D907,606	S	*	1/2021	Lin	.....	D14/223
D907,607	S	*	1/2021	Deng	.....	D14/223
2017/0164087	A1	*	6/2017	Kurtz	.....	H04R 1/105
2021/0013917	A1	*	1/2021	McCaughy	.....	H04B 5/0006

OTHER PUBLICATIONS

Realme Buds Air true-wireless earbuds officially launched in China, announced Jan. 7, 2020 [online], retrieved Jan. 27, 2021, retrieved

from internet, <https://www.gizmochina.com/2020/01/07/realme-buds-air-launched-china/> (Year: 2020).\*

Realme Buds Air review, announced Dec. 2020 [online], retrieved Dec. 27, 2019, retrieved from internet, <https://www.livemint.com/technology/tech-reviews/realme-buds-air-review-ask-yourself-why-you-want-wireless-headphones-11577363150729.html> (Year: 2019).\*

Streetz True Wireless Ear Buds, announced Dec. 2020 [online], retrieved May 2020, retrieved from internet, <https://www.smythstoy.com/ie/en-ie/gift-finder-for-big-kids/streetz-true-wireless-ear-buds-white/p/187324> (Year: 2020).\*

JBL TUNE 205BT, announced Dec. 2020 [online], retrieved Jan. 2019, retrieved from internet, [https://www.jbl.com/earbuds/JBL+TUNE+205BT.html?dwvar\\_JBL%20TUNE%20205BT\\_color=Black-USA-Current&cgid=earbuds#start=1](https://www.jbl.com/earbuds/JBL+TUNE+205BT.html?dwvar_JBL%20TUNE%20205BT_color=Black-USA-Current&cgid=earbuds#start=1) (Year: 2020).\*

Realme Buds Air vs Apple AirPods 2: Inspired by the Best in the Industry, announced Dec. 20, 2019 [online], retrieved Jan. 28, 2021, retrieved from internet, <https://www.gizmochina.com/2019/12/20/realme-buds-air-vs-apple-airpods-inspired-by-the-best-in-the-industry/> (Year: 2019).\*

Apple AirPods (2nd Generation), announced Mar. 29, 2019 [online], retrieved Jan. 28, 2021, retrieved from internet, <https://uk.pcmag.com/headphones/120302/apple-airpods-2nd-generation> (Year: 2019).\*

\* cited by examiner

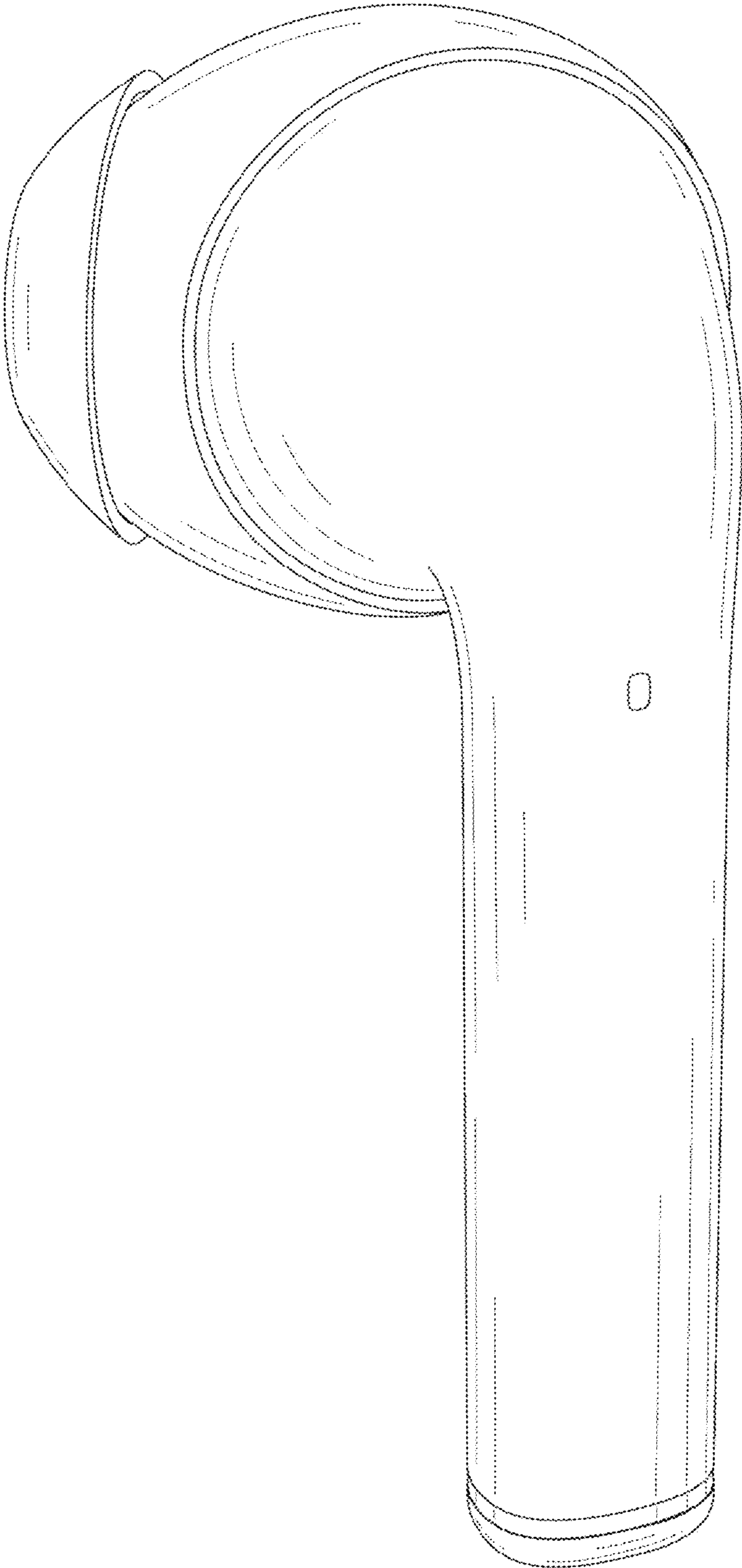
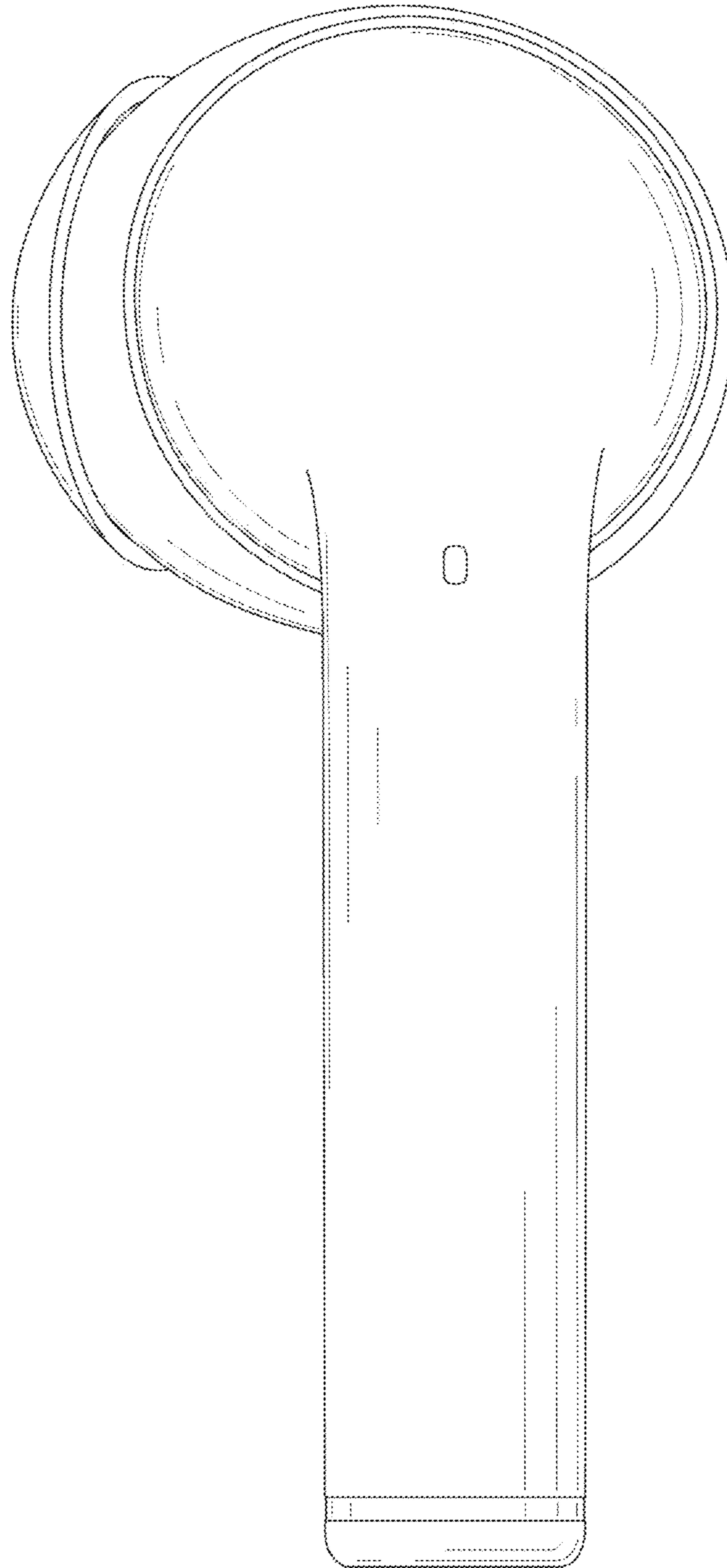
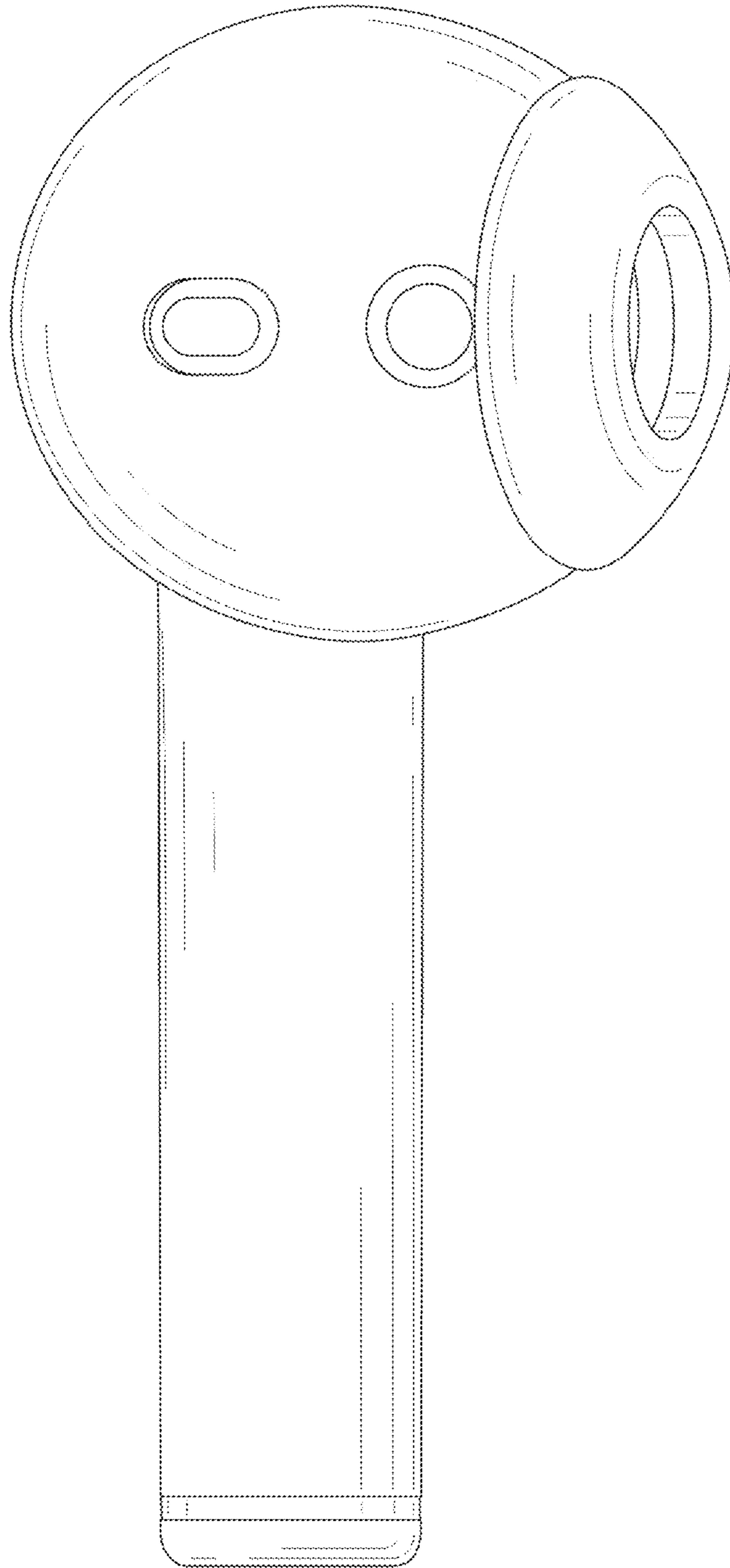

FIG. 1



**FIG. 2**



**FIG. 3**

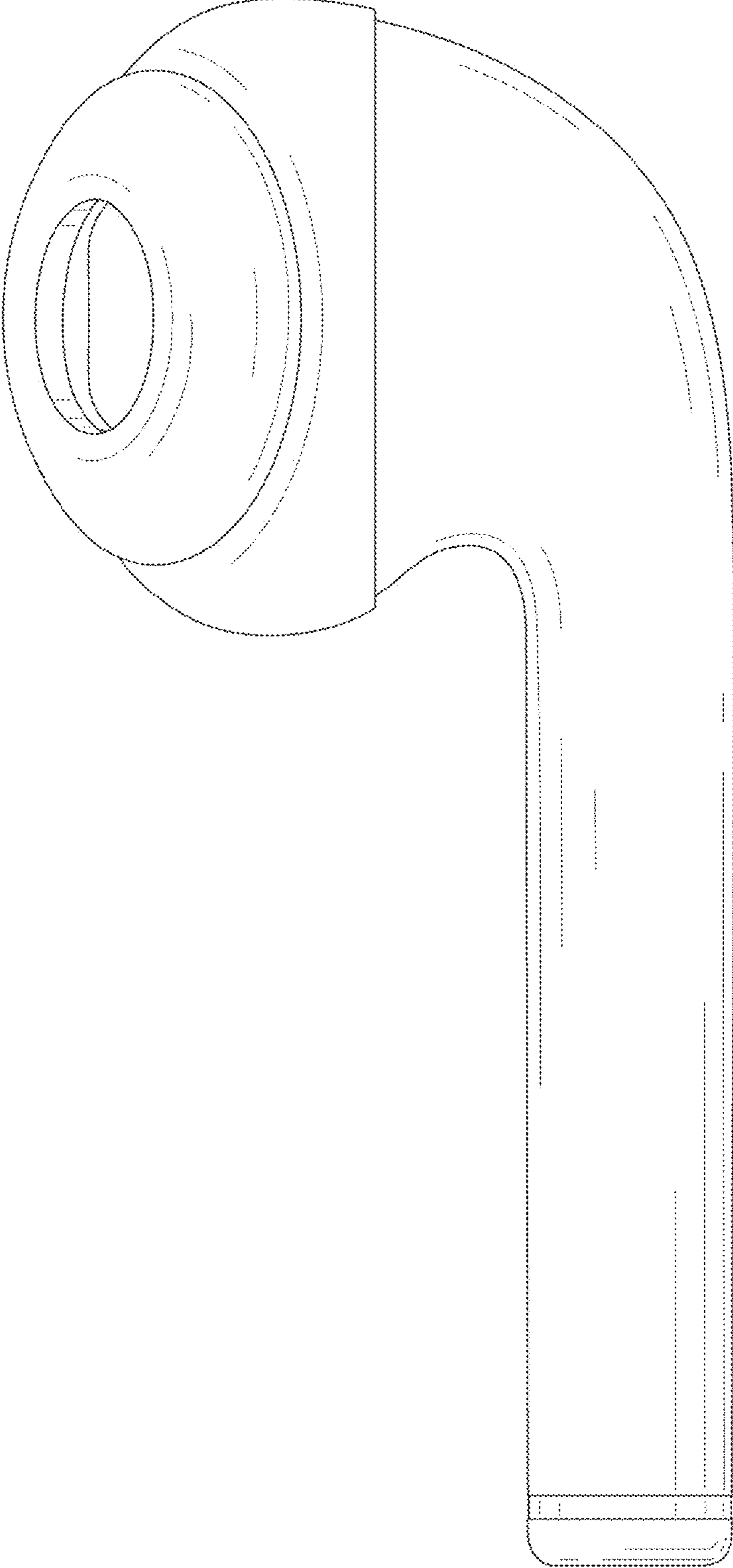
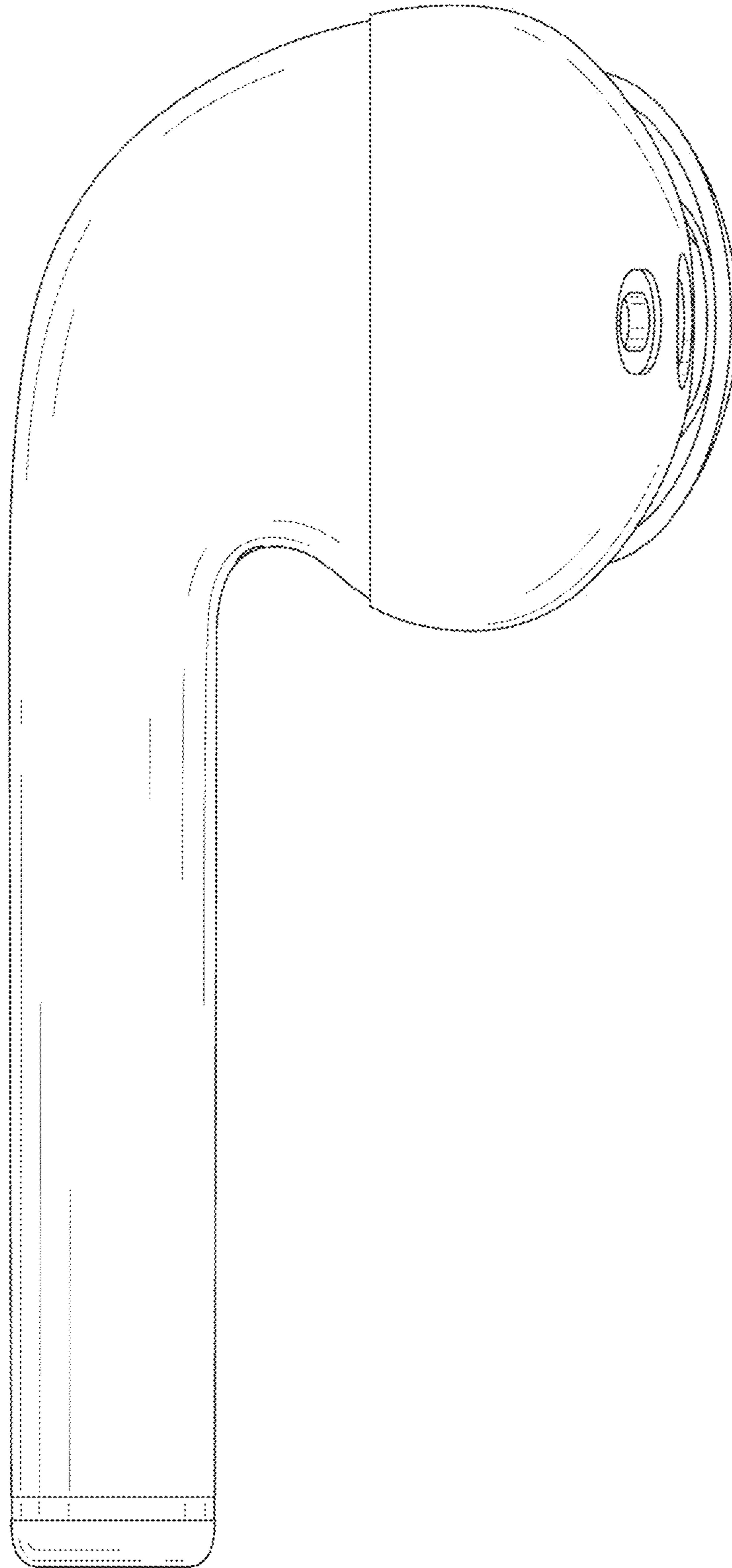
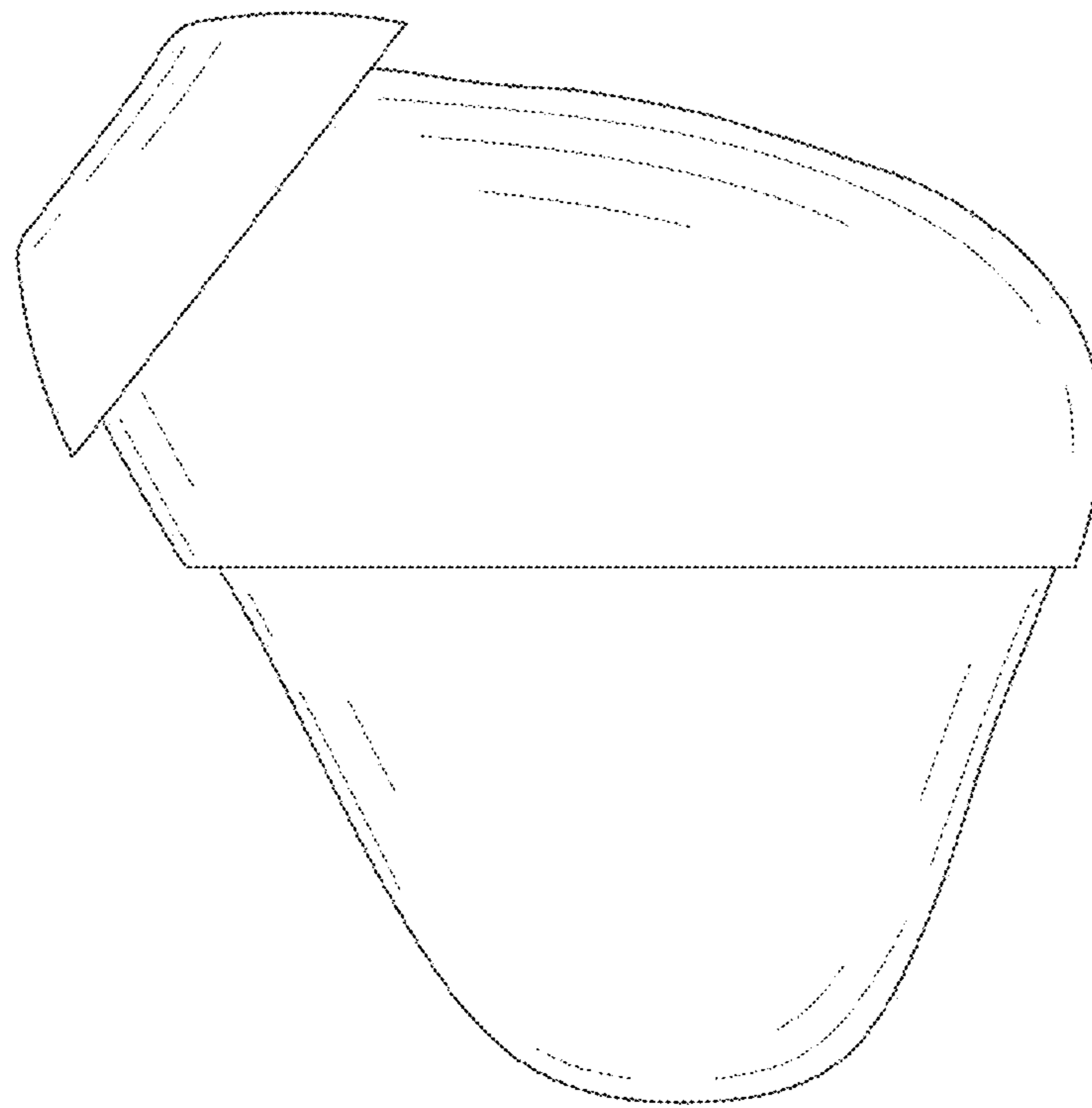

FIG. 4

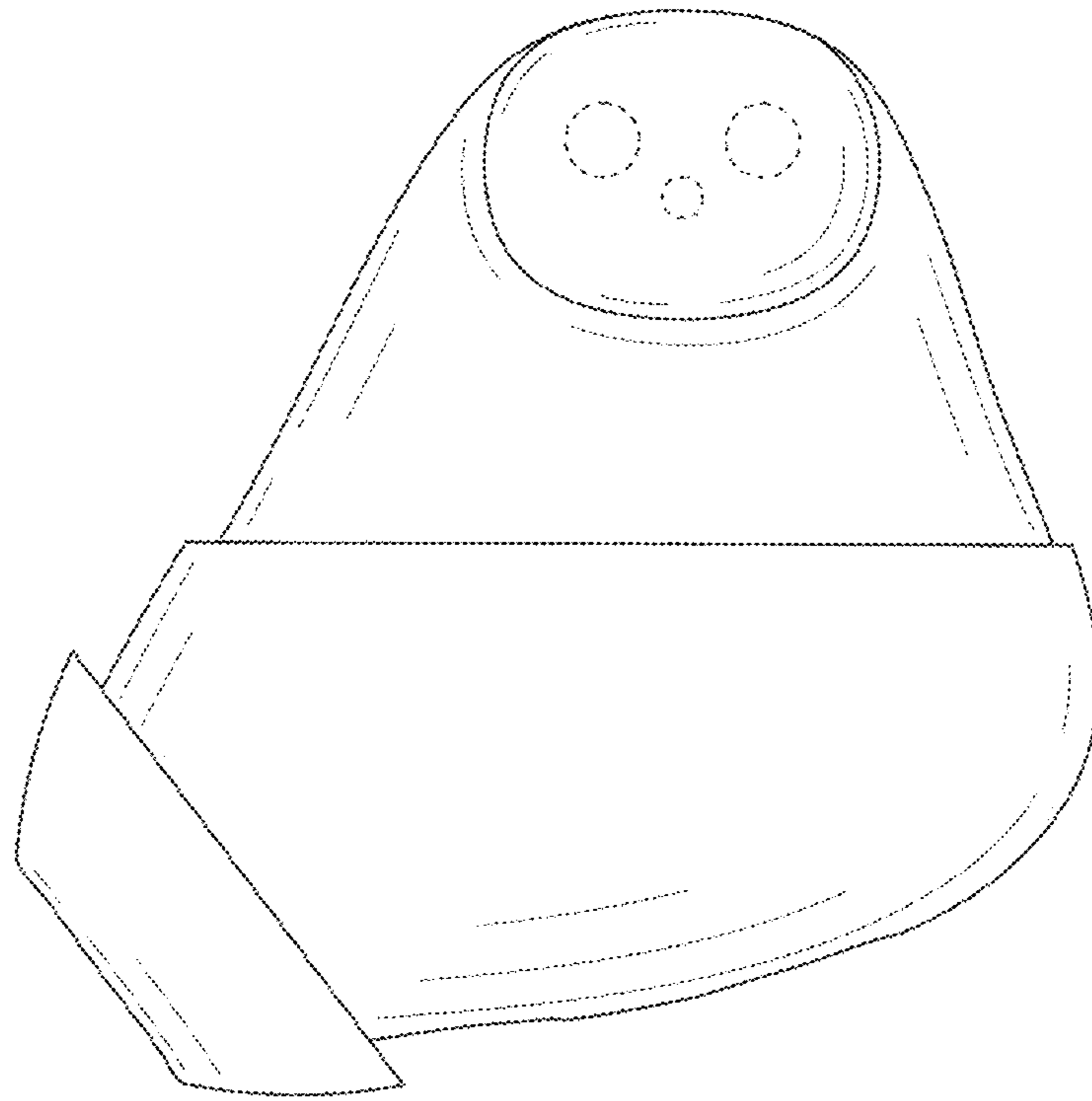

**FIG. 5**



**FIG. 6**





**FIG. 7**