



US00D915351S

(12) **United States Design Patent** (10) **Patent No.:** **US D915,351 S**
Liao (45) **Date of Patent:** **** Apr. 6, 2021**

(54) **SPEAKER**
(71) Applicant: **BEIJING XIAOMI MOBILE SOFTWARE CO., LTD.**, Beijing (CN)
(72) Inventor: **Xia Liao**, Beijing (CN)
(73) Assignee: **Beijing Xiaomi Mobile Software Co., Ltd.**, Beijing (CN)

D713,405 S * 9/2014 Akana D14/358
D729,205 S * 5/2015 Shu D14/216
D739,845 S * 9/2015 Hwang D14/214
D753,628 S * 4/2016 McManigal D14/214
D760,691 S * 7/2016 Paslawski D14/214
D790,539 S * 6/2017 Lee D14/358

(Continued)

(**) Term: **15 Years**
(21) Appl. No.: **35/508,402**

CN 304332955 S 10/2017
CN 304400246 S 12/2017

(Continued)

(22) Filed: **Oct. 12, 2019**

OTHER PUBLICATIONS

(80) **Hague Agreement Data**
Int. Filing Date: **Oct. 12, 2019**
Int. Reg. No.: **DM/205266**
Int. Reg. Date: **Oct. 12, 2019**
Int. Reg. Pub. Date: **Jan. 24, 2020**

Notice of Allowance of the Taiwanese application No. 108306513, dated Jan. 21, 2020.

Primary Examiner — Bao-Yen T Nguyen
(74) *Attorney, Agent, or Firm* — Syncoda LLC; Feng Ma

(30) **Foreign Application Priority Data**

(57) **CLAIM**

Apr. 23, 2019 (CN) 201930188579.2
(51) **LOC (13) Cl.** **14-01**

The ornamental design for a speaker, as shown and described.

(52) **U.S. Cl.**
USPC **D14/214**

(58) **Field of Classification Search**
USPC D14/167, 168, 170–172, 188, 194–196, D14/209.1, 204, 210–216, 219, 221, 222, D14/224, 239, 496
CPC H04R 1/02; H04R 1/021; H04R 1/026; H04R 1/028; H04R 1/403; H04R 1/2803; H04R 5/02; H04R 9/06; H04R 9/13; H04R 2201/021; H04R 2400/00; H04R 2499/11
See application file for complete search history.

DESCRIPTION

- 1.-2. Speaker
- 1.1 : Front
- 1.2 : Back
- 1.3 : Left
- 1.4 : Right
- 1.5 : Top
- 1.6 : Bottom
- 1.7 : Perspective view 1
- 1.8 : Perspective view 2
- 2.1 : Front
- 2.2 : Back
- 2.3 : Left
- 2.4 : Right

(56) **References Cited**
U.S. PATENT DOCUMENTS

D675,190 S * 1/2013 Nylén D14/215
D710,329 S * 8/2014 Holzer D14/216

(Continued)

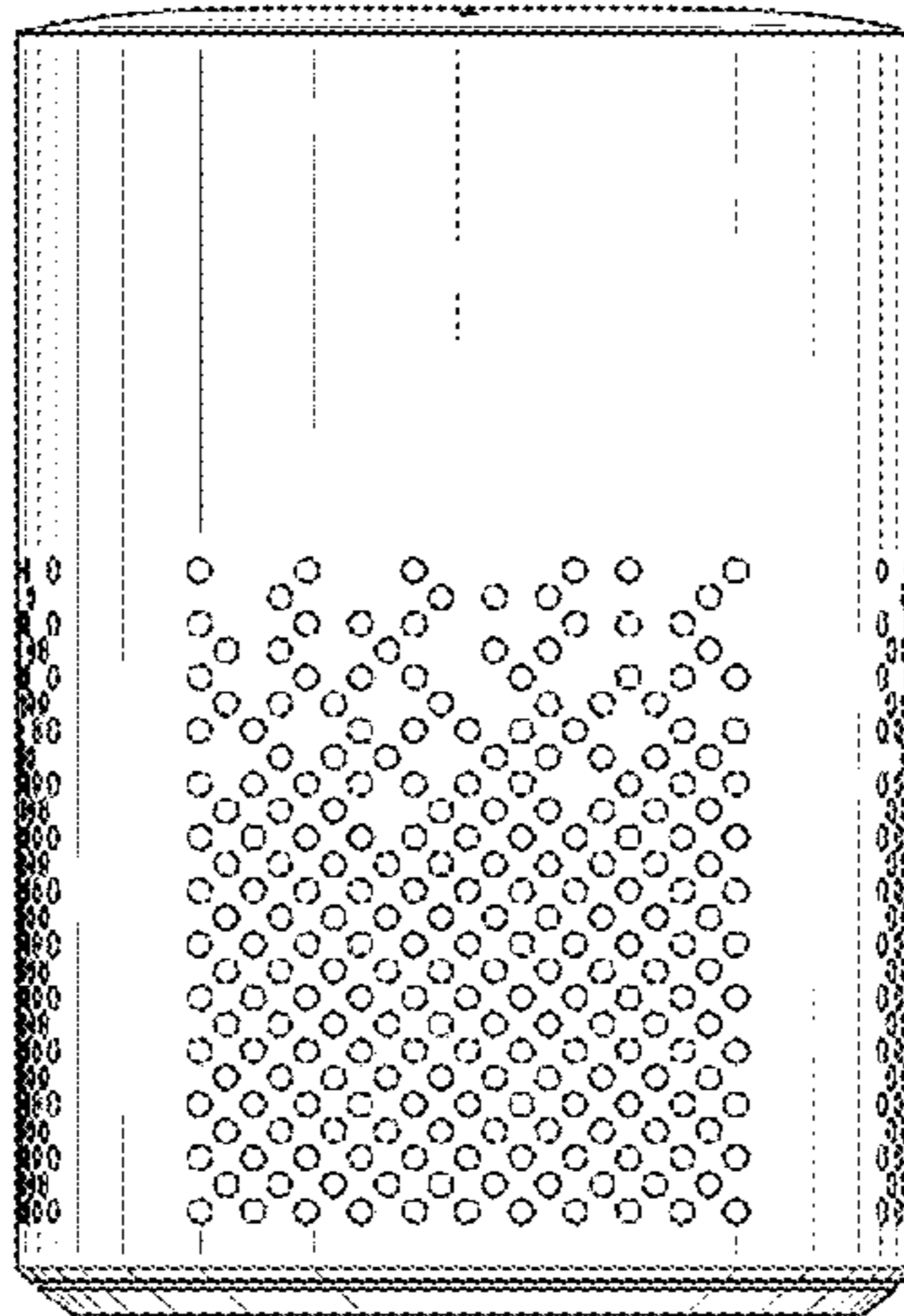

US D915,351 S

Page 2

2.5 : Top
2.6 : Bottom
2.7 : Perspective

1 Claim, 15 Drawing Sheets

(56)

References Cited

U.S. PATENT DOCUMENTS

D809,480 S * 2/2018 Schaal D14/214
D829,687 S * 10/2018 Burlingame D14/214
D836,606 S * 12/2018 Kangasmaa D14/216
D837,182 S * 1/2019 Elmieh D14/204
D845,276 S * 4/2019 Huang D14/216
D854,509 S * 7/2019 Wu D14/168
D873,242 S * 1/2020 Kosaka D14/214

D873,244 S * 1/2020 Lee D14/216
D877,121 S * 3/2020 Gurkin D14/214
D882,548 S * 4/2020 Guo D14/216
D882,549 S * 4/2020 Ohno D14/216
D883,275 S * 5/2020 Zhang D14/299
D886,779 S * 6/2020 Delpier D14/204
D886,783 S * 6/2020 Widiaman D14/204
D900,769 S * 11/2020 Yi D14/126
2008/0181416 A1* 7/2008 Jung H04R 1/403
381/2
2017/0025124 A1* 1/2017 Mixter G10L 15/32
2019/0200153 A1* 6/2019 Gurkin H04S 3/008
2020/0068280 A1* 2/2020 Nam H04R 1/26

FOREIGN PATENT DOCUMENTS

CN 304420647 S 12/2017
EM 0054925010001 8/2018
JP D1603389 S 5/2018

* cited by examiner

1.1

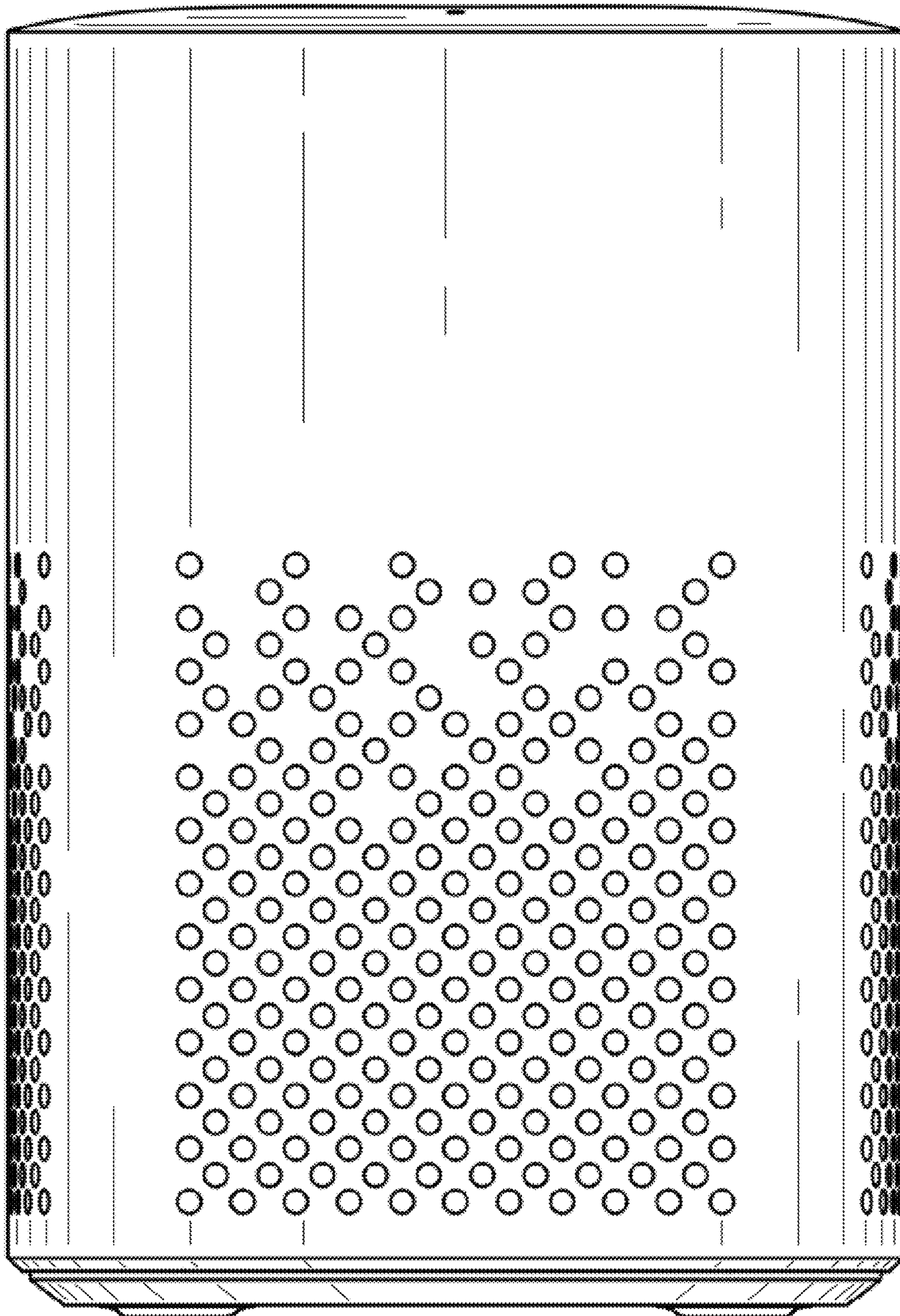

1.2

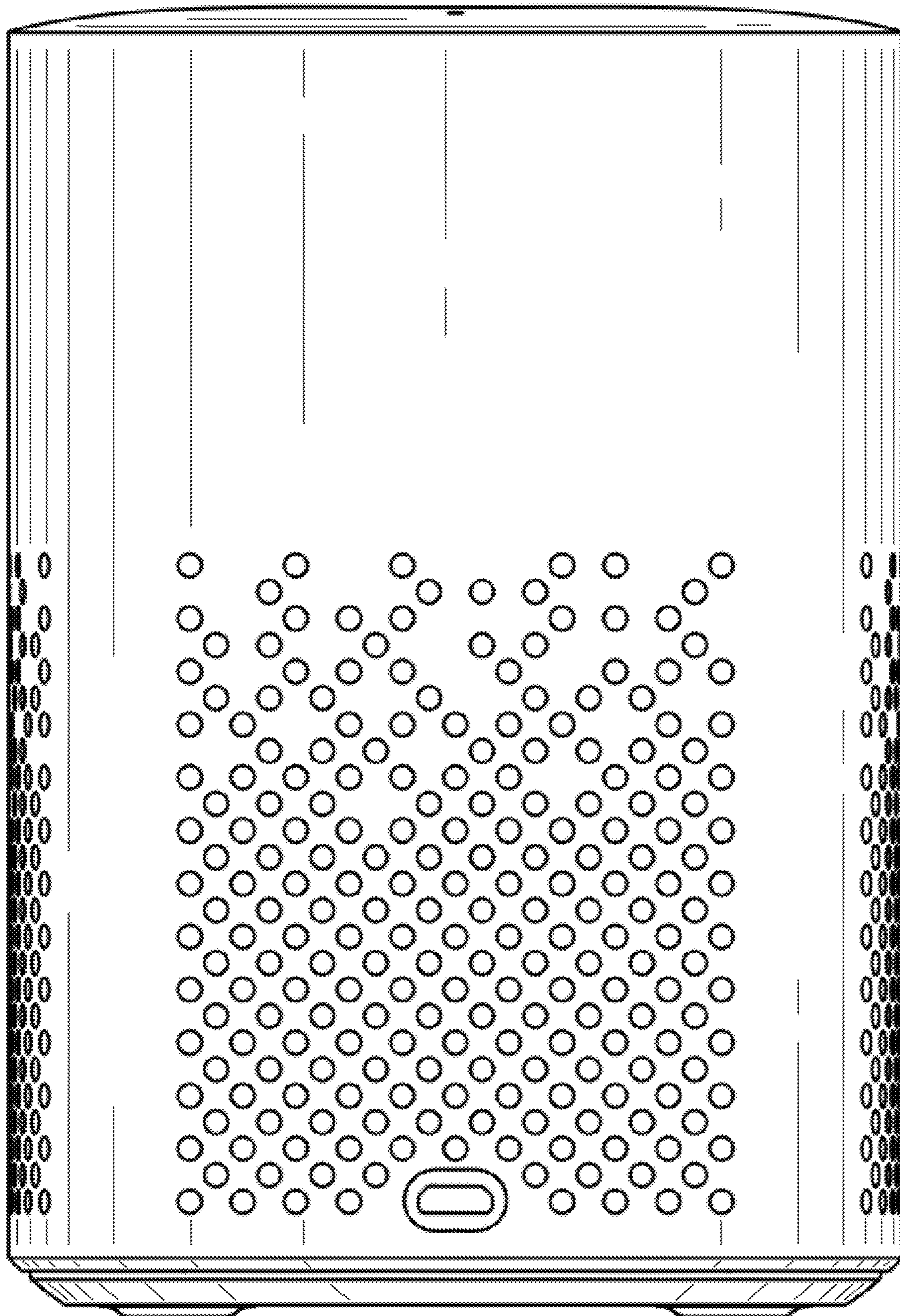

1.3

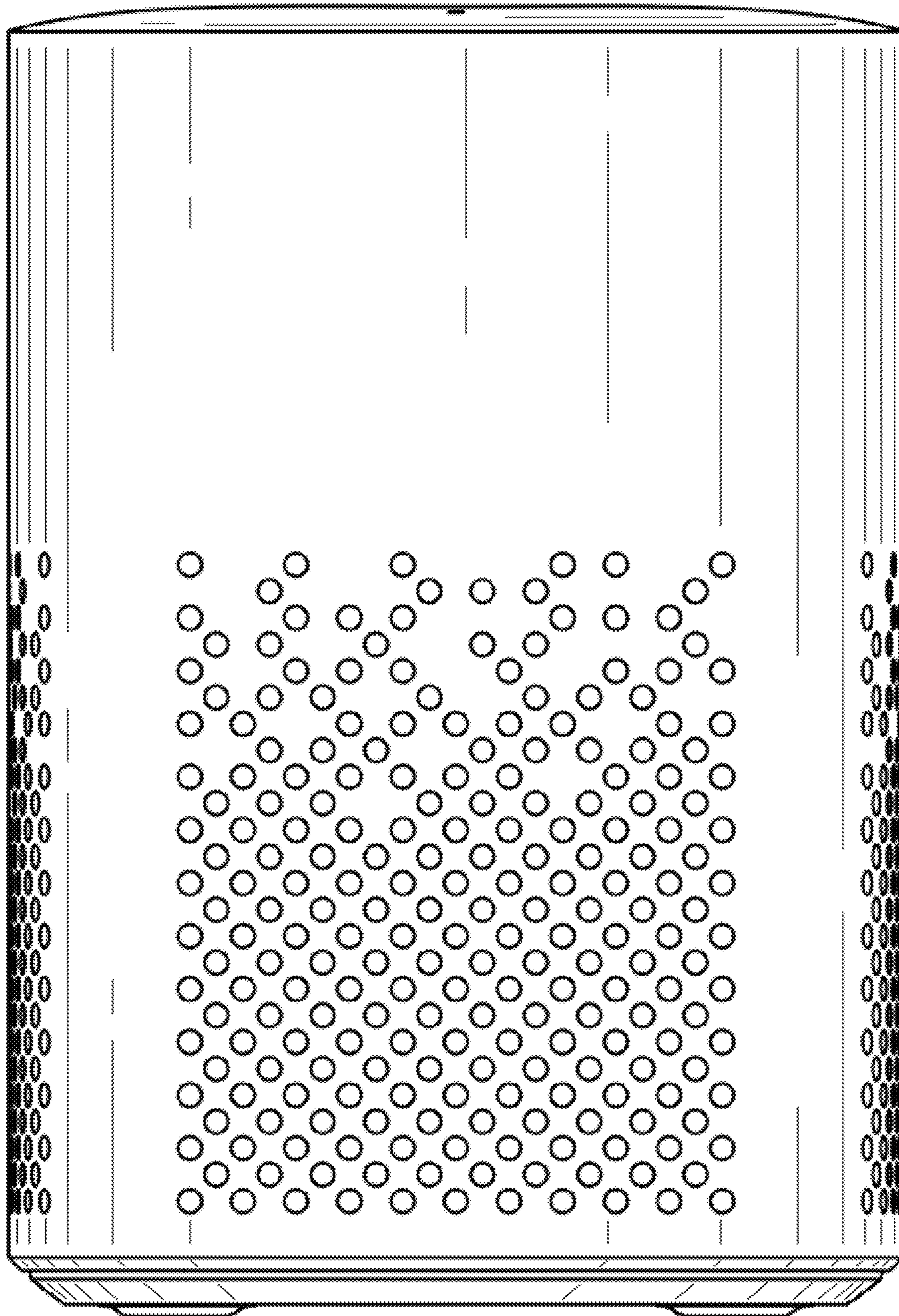

1.4

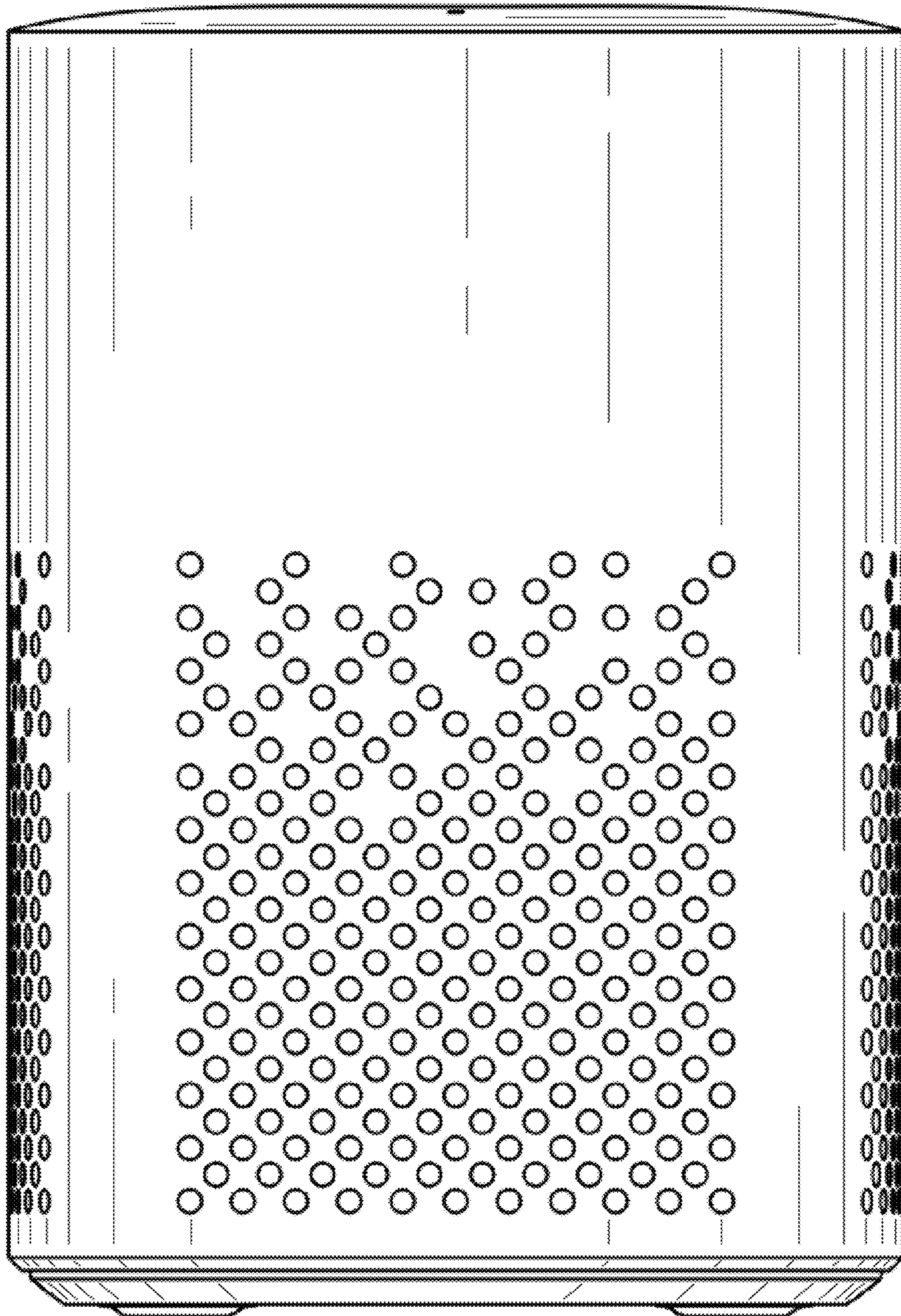

1.5

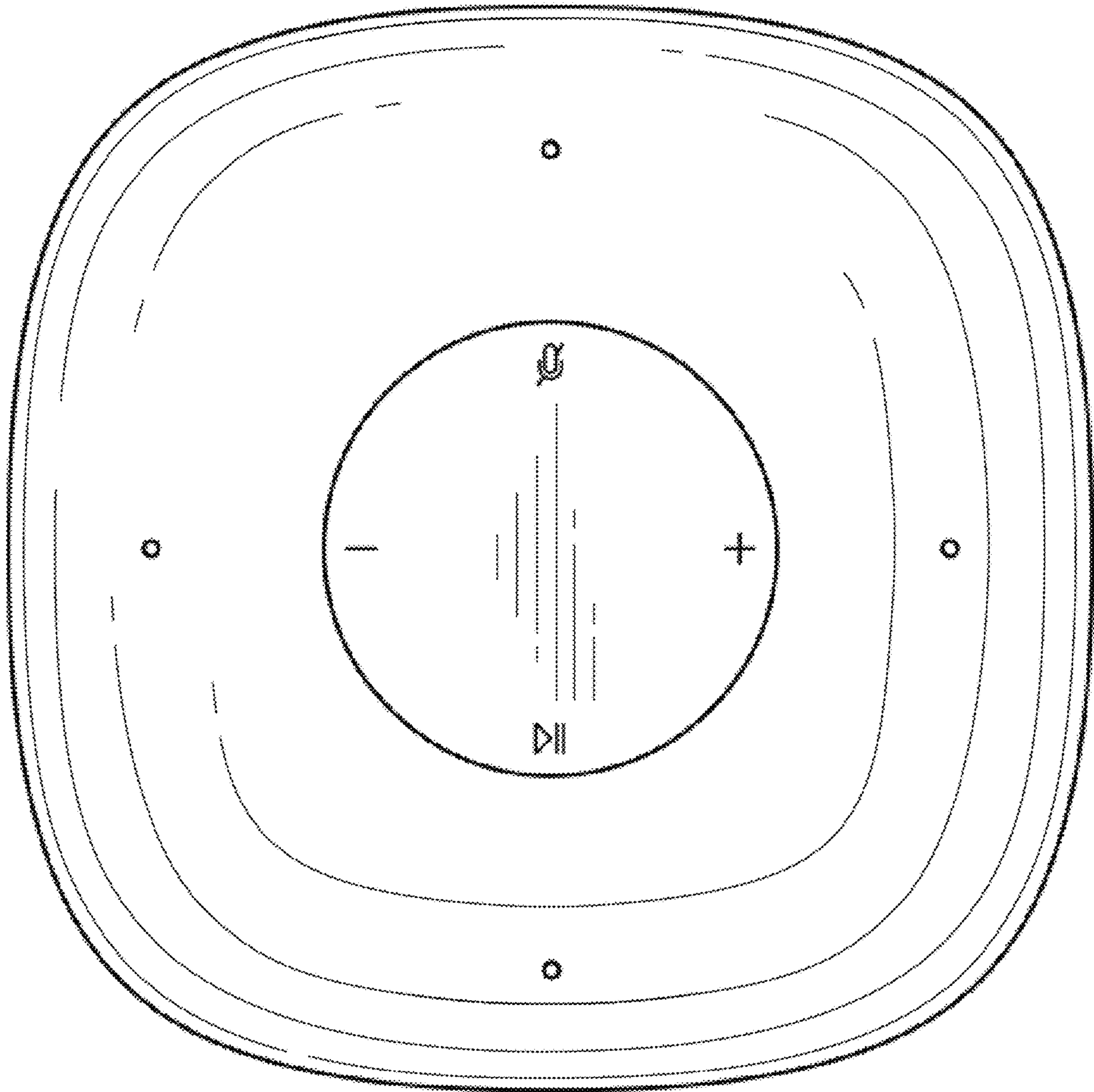

1.6

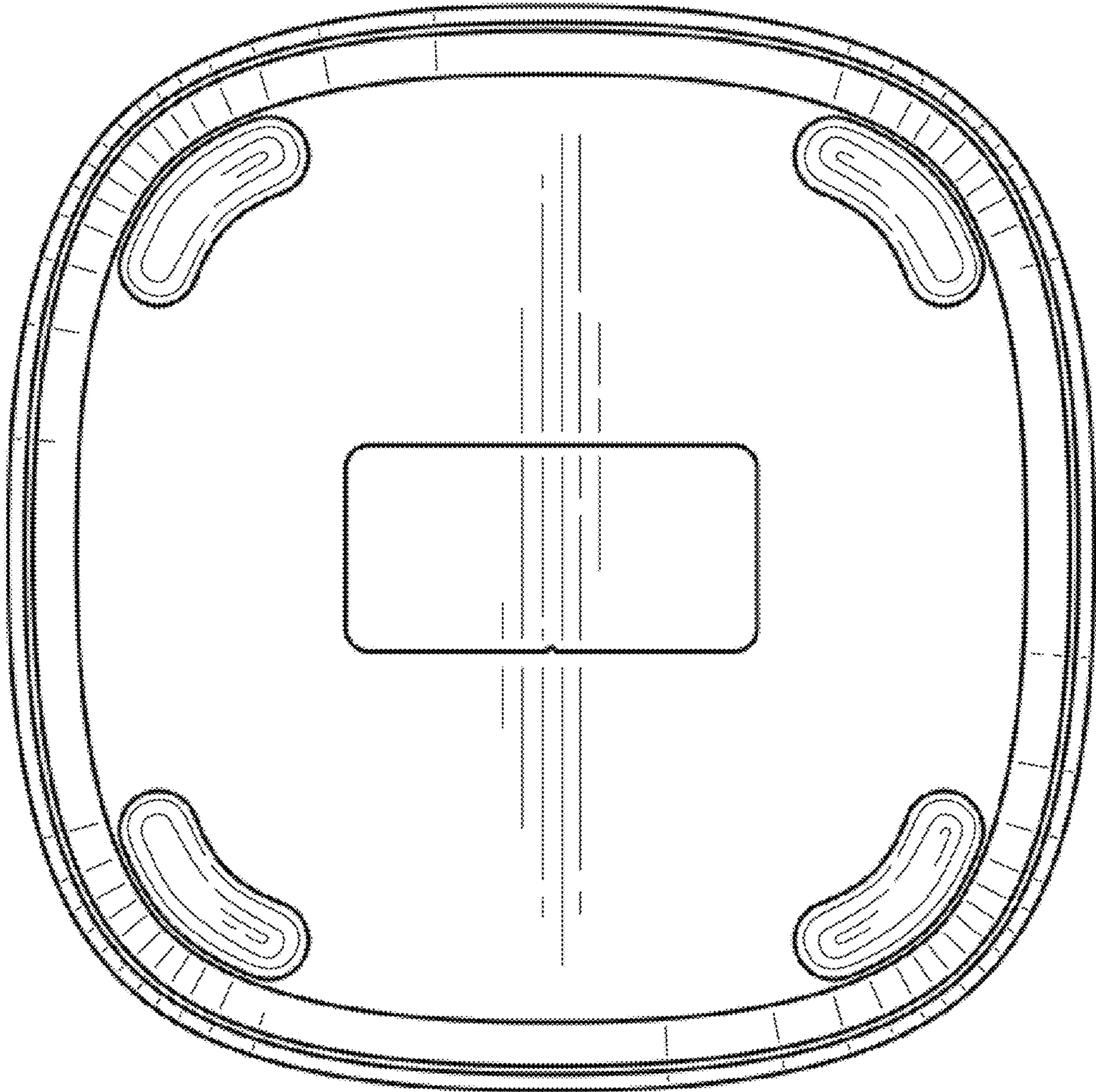

1.7

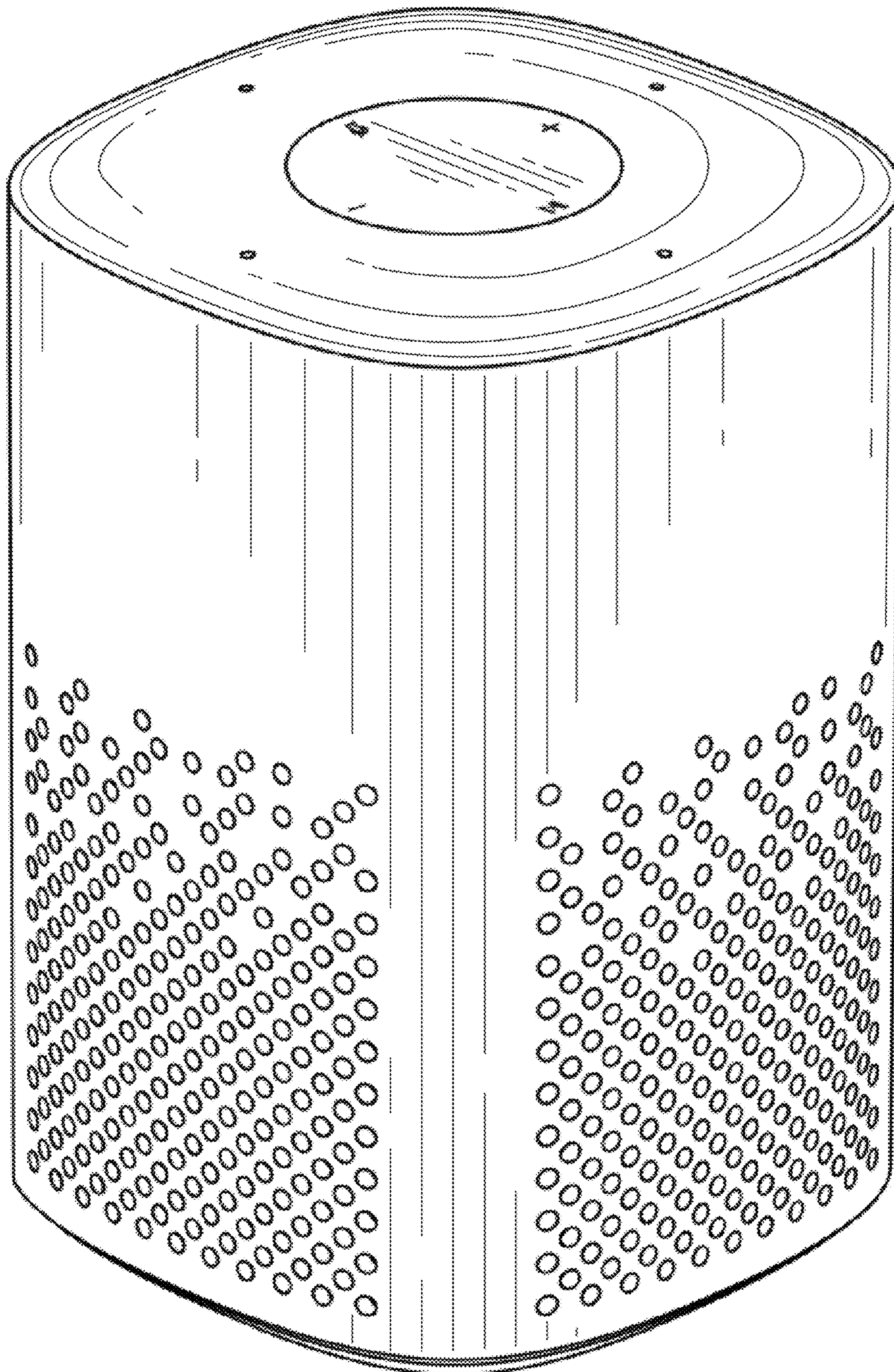

1.8

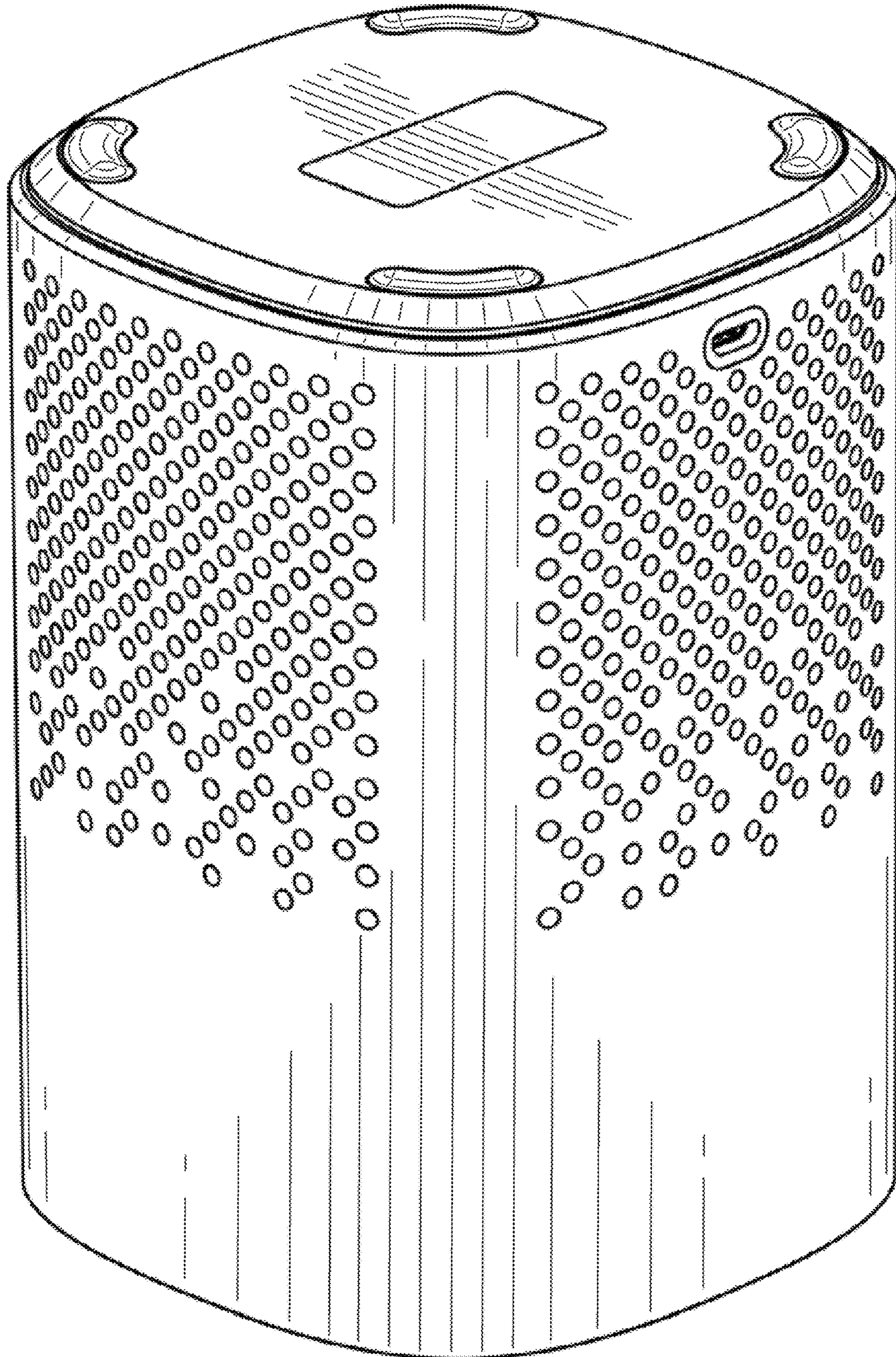

2.1

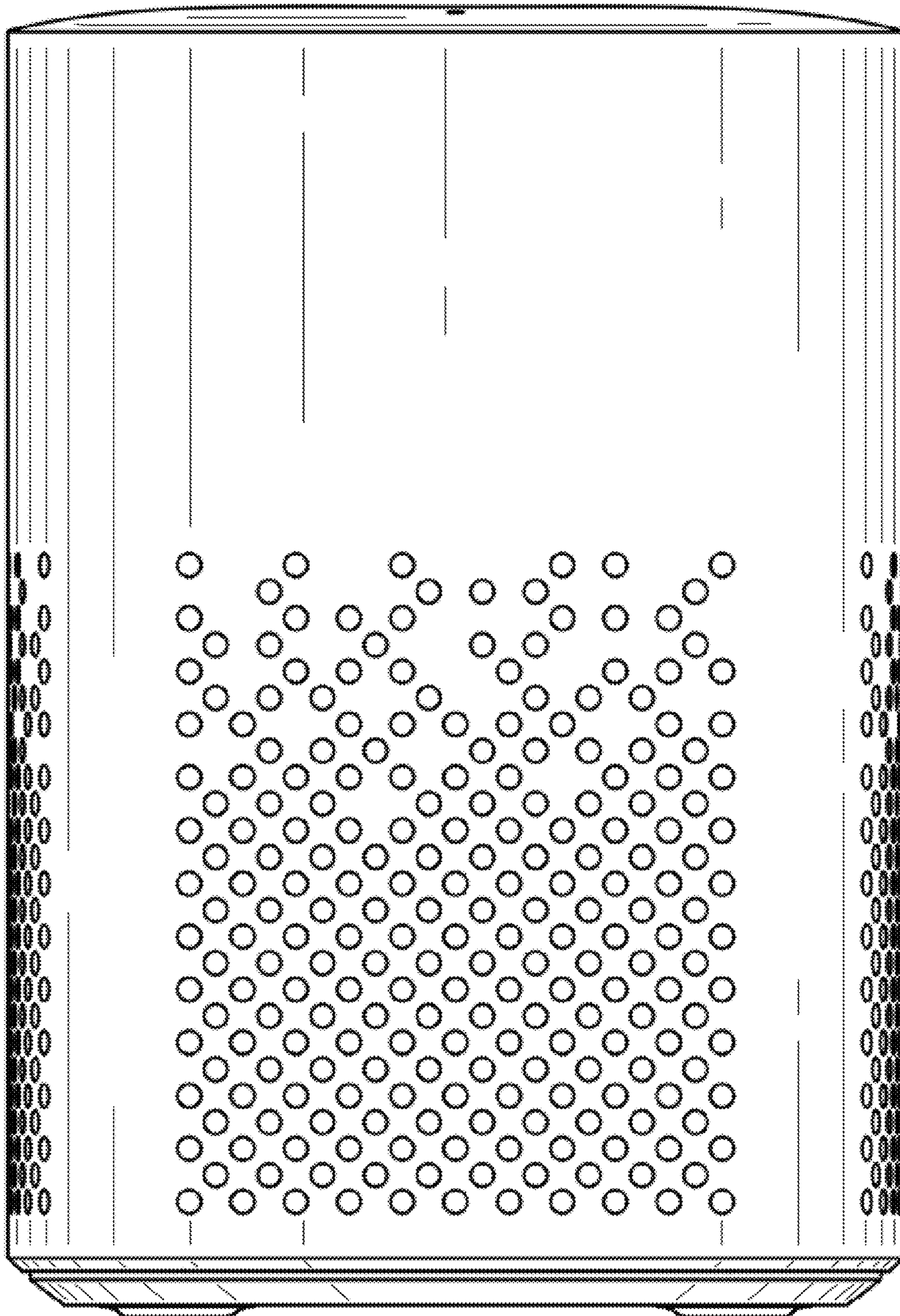

2.2

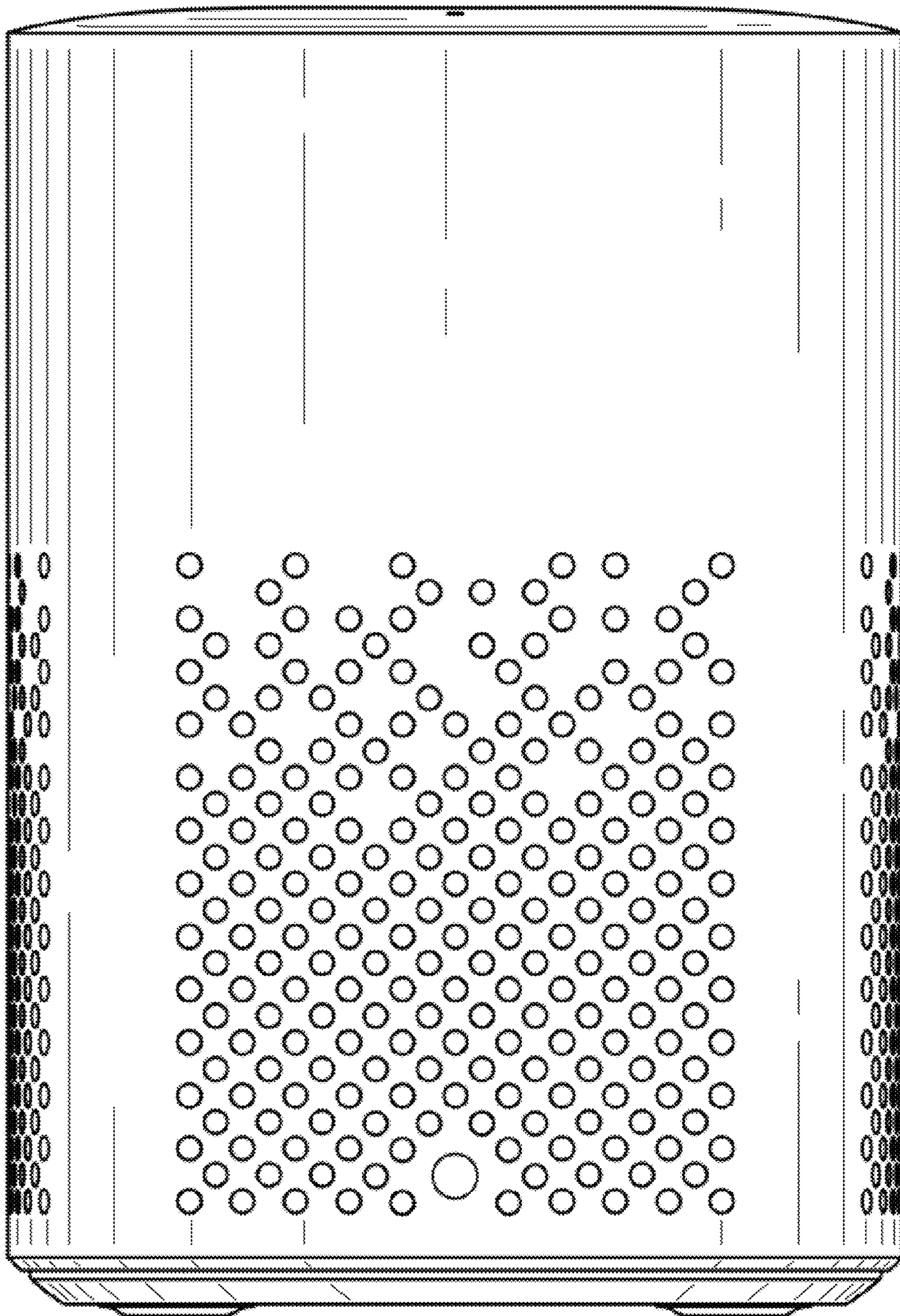

2.3

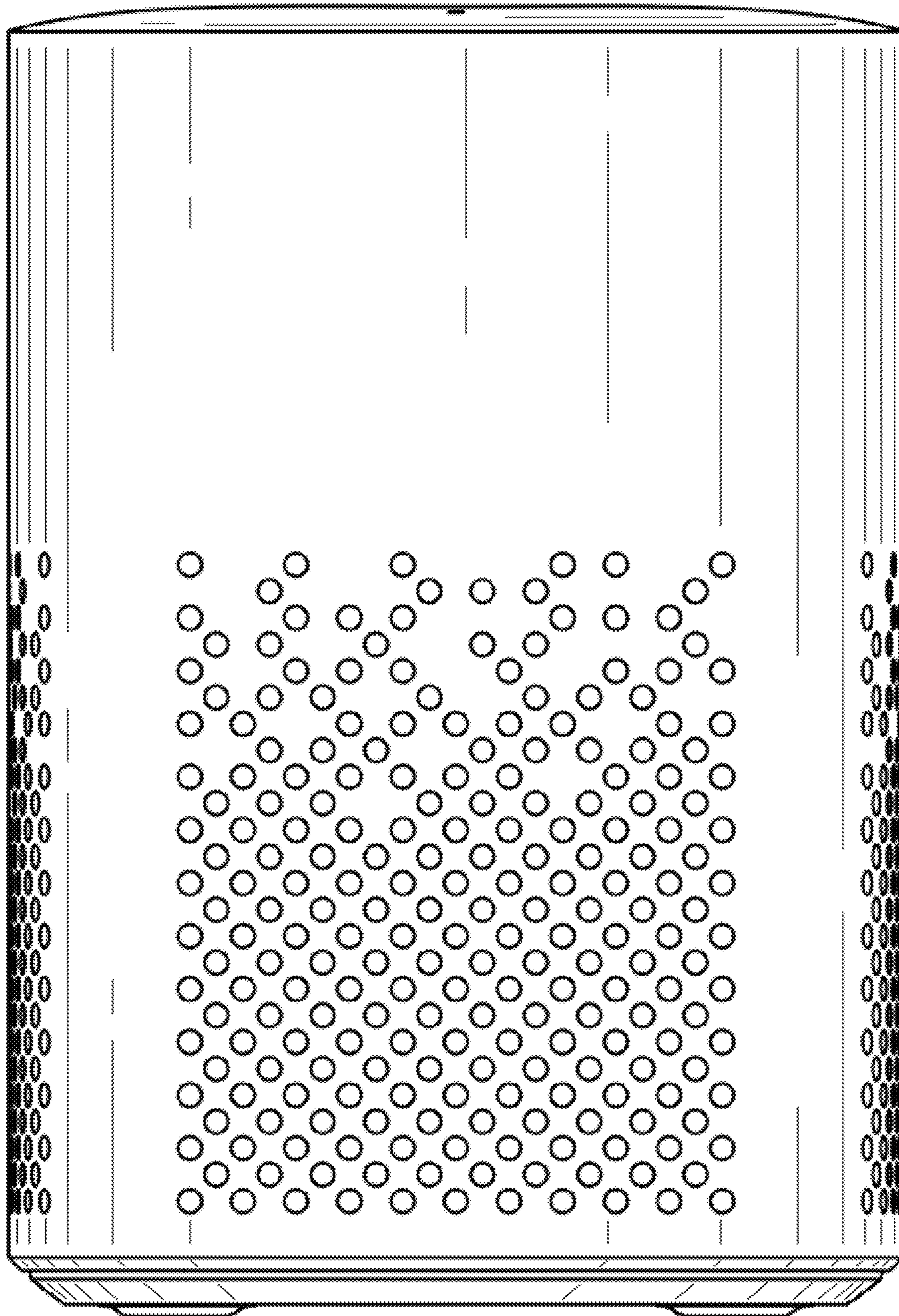

2.4

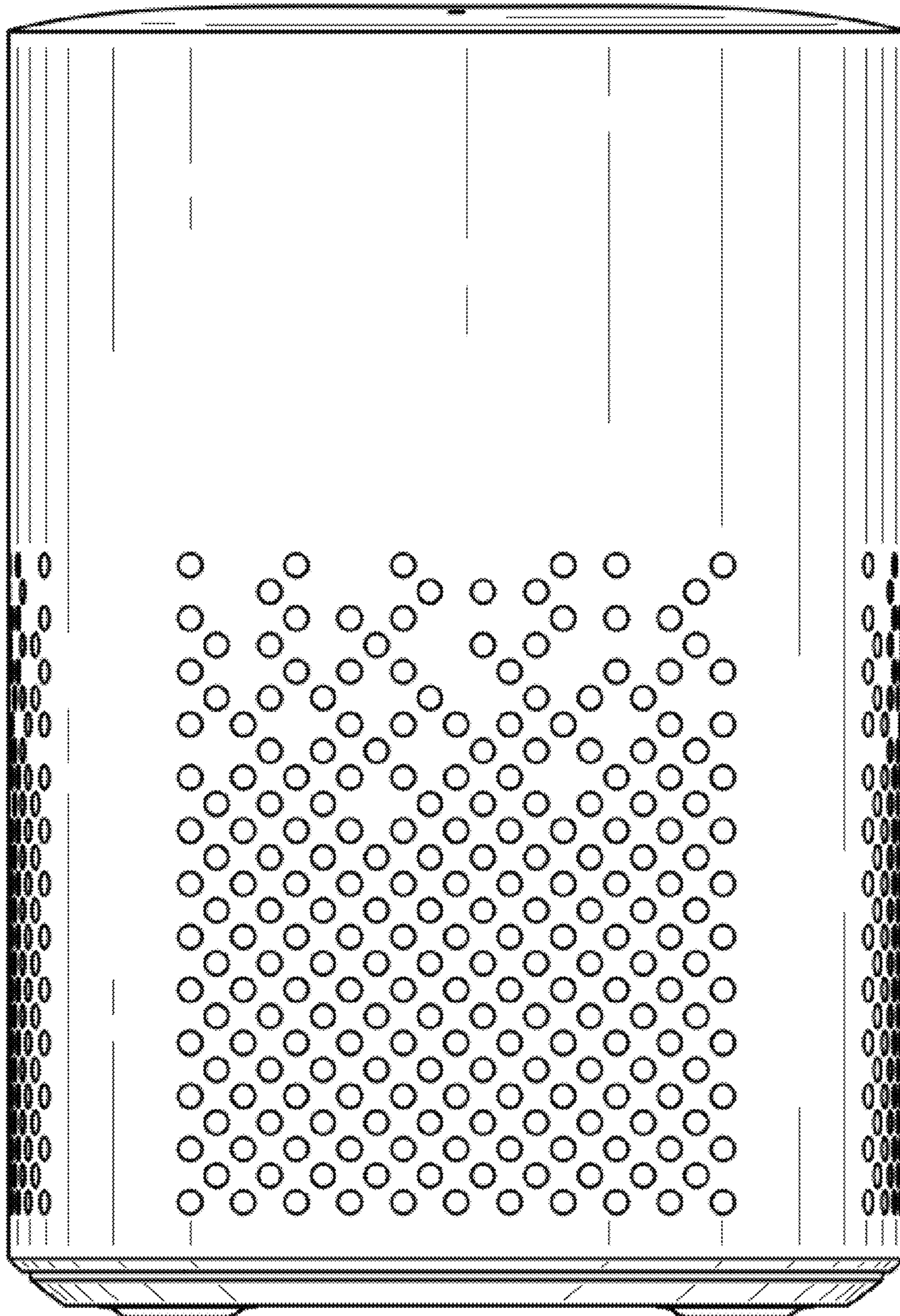

2.5

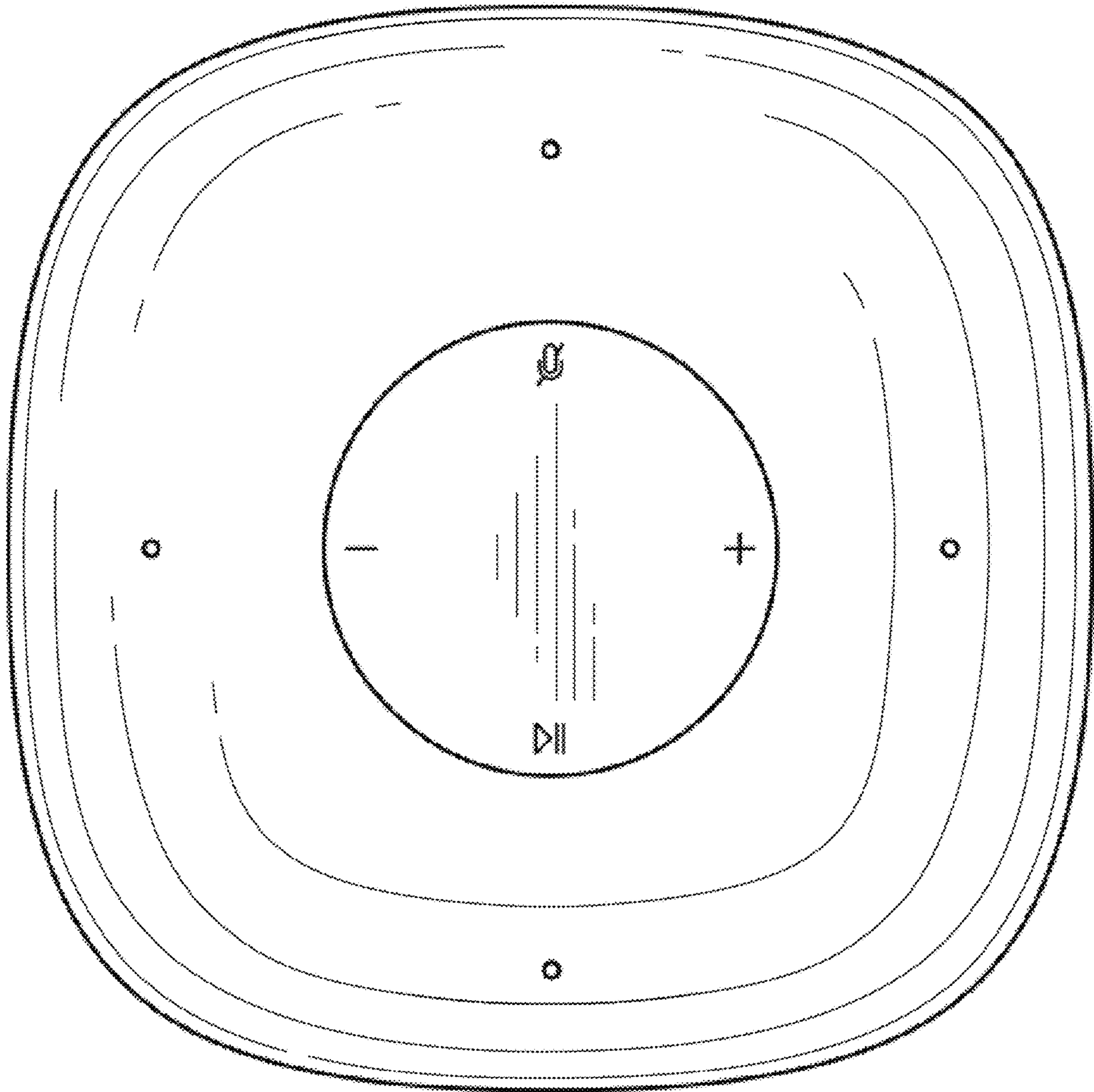

2.6

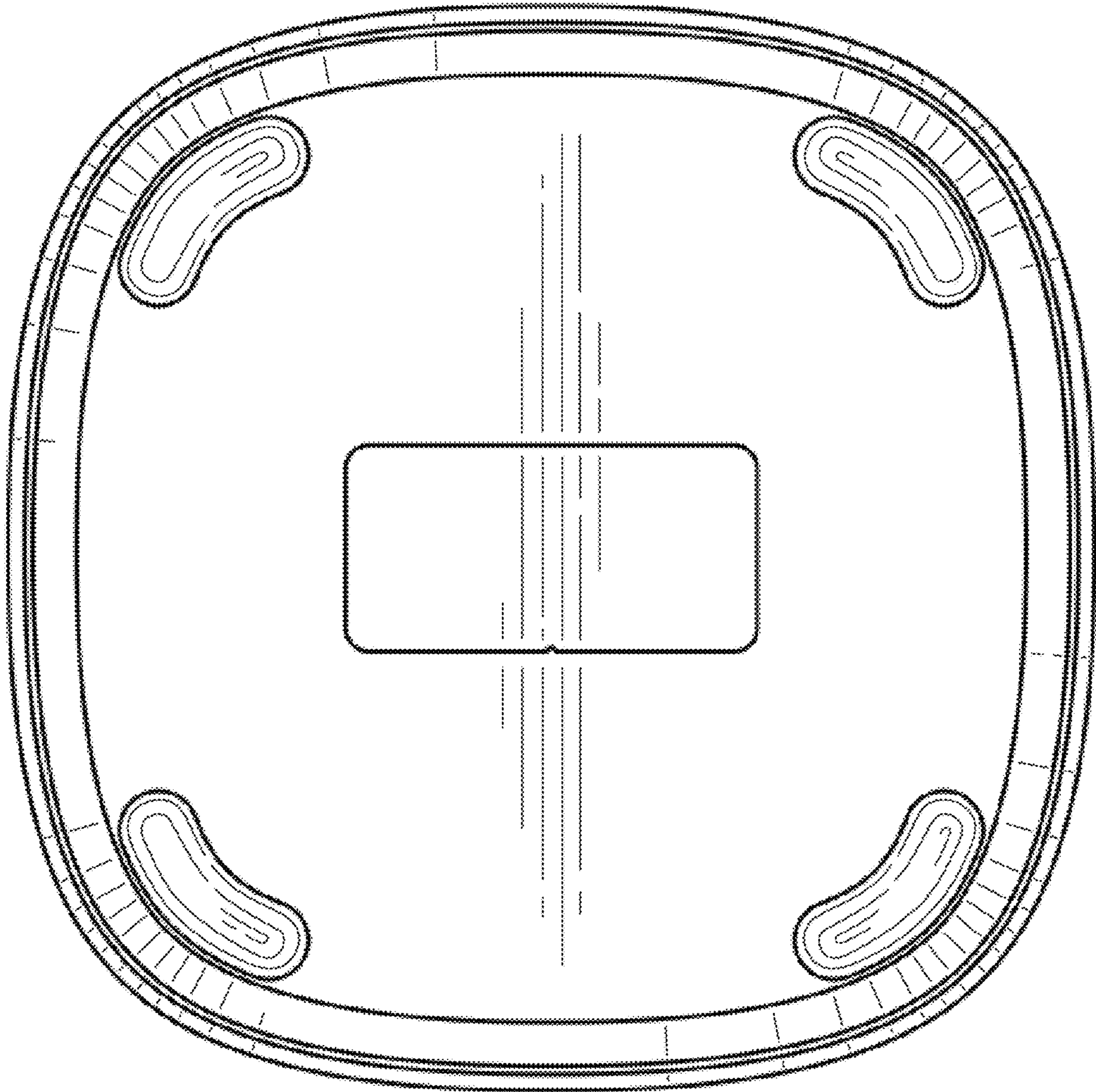

2.7

