



US00D915324S

(12) **United States Design Patent** (10) **Patent No.:** **US D915,324 S**
Park et al. (45) **Date of Patent:** **** *Apr. 6, 2021**

(54) **MOBILE PHONE**

(71) Applicant: **LG Electronics Inc.**, Seoul (KR)

(72) Inventors: **Doyoung Park**, Seoul (KR); **Youngho Kim**, Seoul (KR); **Youngjoo Cho**, Seoul (KR)

(73) Assignee: **LG ELECTRONICS INC.**, Seoul (KR)

(*) Notice: This patent is subject to a terminal disclaimer.

(**) Term: **15 Years**

(21) Appl. No.: **35/507,665**

(22) Filed: **Apr. 19, 2019**

(80) **Hague Agreement Data**

Int. Filing Date: **Apr. 19, 2019**

Int. Reg. No.: **DM/203788**

Int. Reg. Date: **Apr. 19, 2019**

Int. Reg. Pub. Date: **Nov. 8, 2019**

(30) **Foreign Application Priority Data**

Nov. 9, 2018 (KR) 30-2018-0051972

(51) **LOC (13) Cl.** **14-03**

(52) **U.S. Cl.**
USPC **D14/138 G**

(58) **Field of Classification Search**

USPC D14/138, 138 AA, 138 G, 203.1, 203.3,
D14/203.5, 203.7, 248, 341, 496;
D21/329, 517

CPC . G06F 1/1626; H04M 1/0266; H04M 1/0202;
H04M 1/026

See application file for complete search history.

(56) **References Cited**

U.S. PATENT DOCUMENTS

D777,151 S * 1/2017 Choe D14/248
D823,845 S * 7/2018 Berneth D14/248
D827,624 S * 9/2018 Berneth D14/248
D827,625 S * 9/2018 Berneth D14/248
D827,626 S * 9/2018 Berneth D14/248
D831,605 S * 10/2018 Baik D14/138 G

(Continued)

OTHER PUBLICATIONS

Huawei P11 X Concept Phone, publication date Dec. 24, 2017, [online][site visited Jul. 30, 2020] URL: <https://www.gizmochina.com/2017/12/24/huawei-p11-x-concept-phone-brings-triple-camera-iphone-like-notch/> (Year: 2017).*

(Continued)

Primary Examiner — L. A. Grabenstetter

(74) *Attorney, Agent, or Firm* — Birch, Stewart, Kolasch & Birch, LLP

(57) **CLAIM**

The ornamental design for a mobile phone, as shown and described.

DESCRIPTION

- 1. Mobile phone
- 1.1 : Front perspective
- 1.2 : Front
- 1.3 : Back
- 1.4 : Left
- 1.5 : Right
- 1.6 : Top
- 1.7 : Bottom
- 1.8 : Back perspective view

The broken lines depict portions of the mobile phone that form no part of the claimed design; reproduction 1.1 is a front perspective view of the mobile phone; reproduction 1.2 is a front view thereof; reproduction 1.3 is a back view thereof; reproduction 1.4 is a left view thereof; reproduction 1.5 is a right view thereof; reproduction 1.6 is a top view thereof; reproduction 1.7 is a bottom view thereof; reproduction 1.8 is a back perspective view thereof.

1 Claim, 8 Drawing Sheets

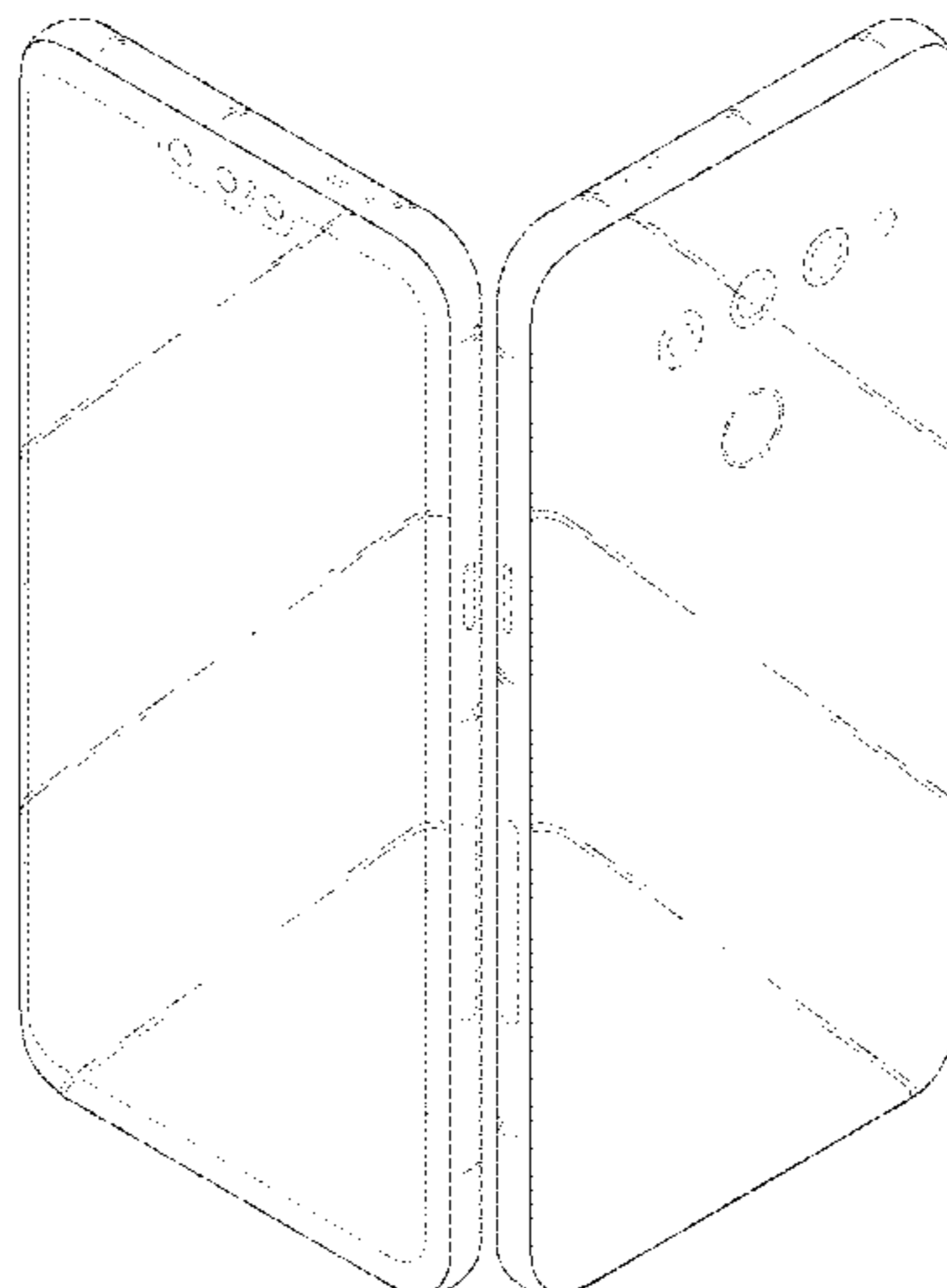

(56)

References Cited

U.S. PATENT DOCUMENTS

D831,626 S * 10/2018 Choe D14/248
D834,552 S * 11/2018 Ryu D14/138 G
D848,390 S * 5/2019 Cha D14/138 G
D849,708 S * 5/2019 Park D14/138 G
D849,709 S * 5/2019 Choi D14/138 G
D851,635 S * 6/2019 Choi D14/239
D874,418 S * 2/2020 Cho D14/138 G

OTHER PUBLICATIONS

The LG V30, publication date Aug. 18, 2017, [online][site visited Jul. 22, 2020] URL: <https://www.theverge.com/2017/8/18/16166402/lg-v30-new-iphone-excitement> (Year: 2017).*

LG V40 ThinQ vs V35 ThinQ, publication date Oct. 4, 2018, [online][site visited Jul. 30, 2020] URL: <https://www.pocket-lint.com/phones/buyers-guides/lg/144658-lg-v35-thinq-vs-lg-v30-vs-lg-v40> (Year: 2018).*

LG V50 ThinQ hands-in, publication date Feb. 24, 2019, [online][site visited Jul. 30, 2020] URL: <https://www.androidauthority.com/lg-v50-review-958113/> (Year: 2019).*

* cited by examiner

1.1

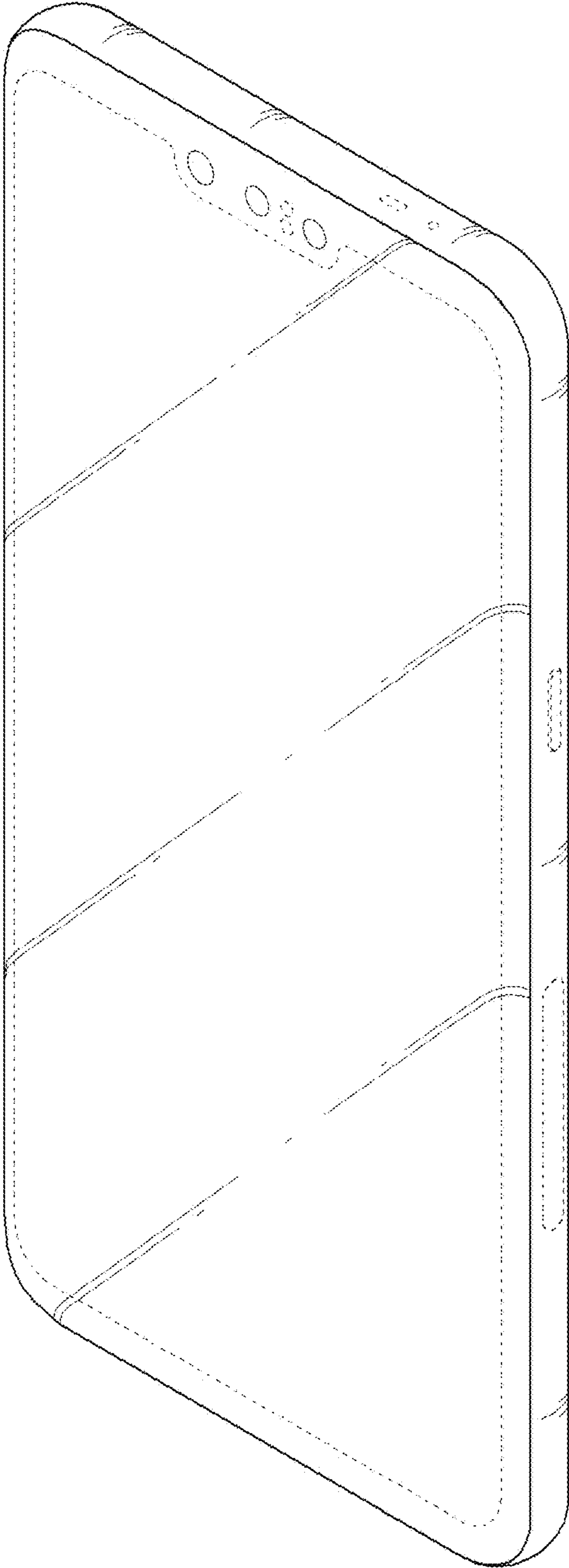

1.2

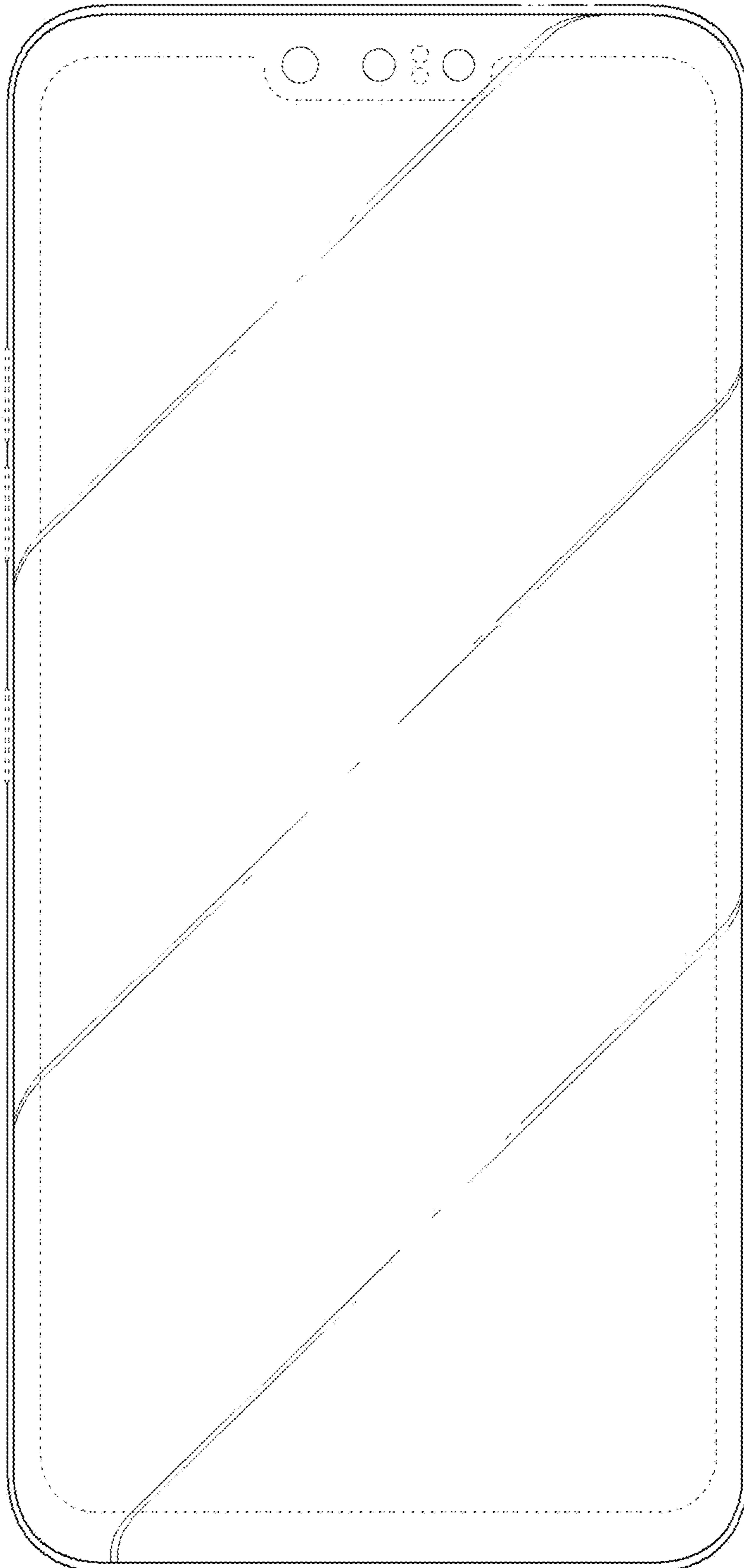

1.3

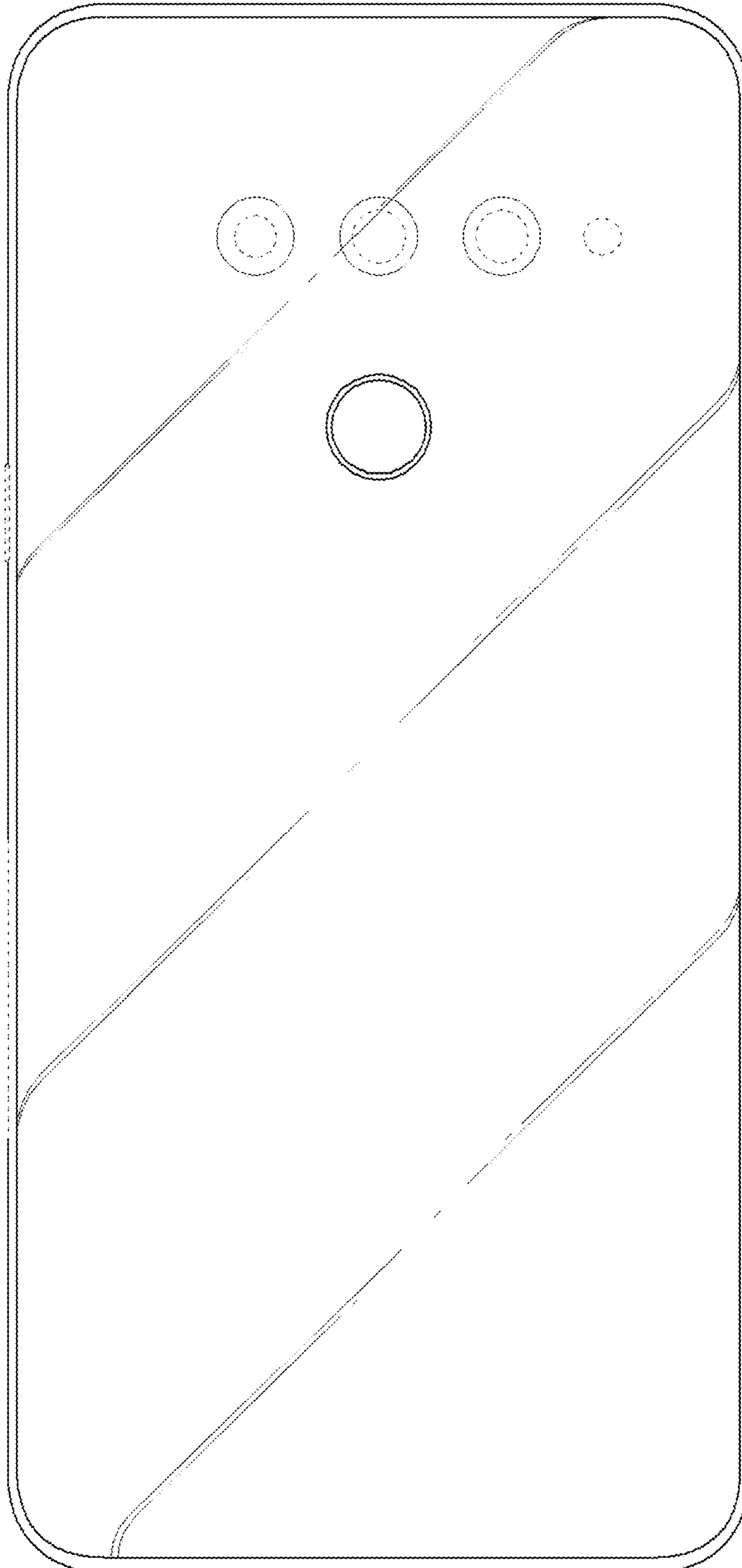

1.4

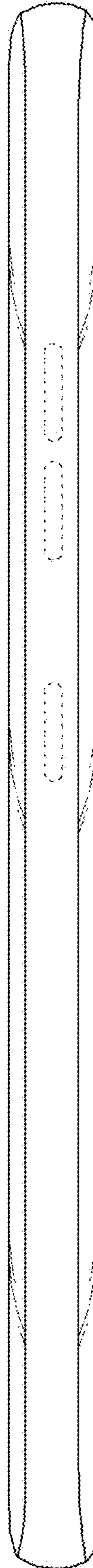

1.5



1.6

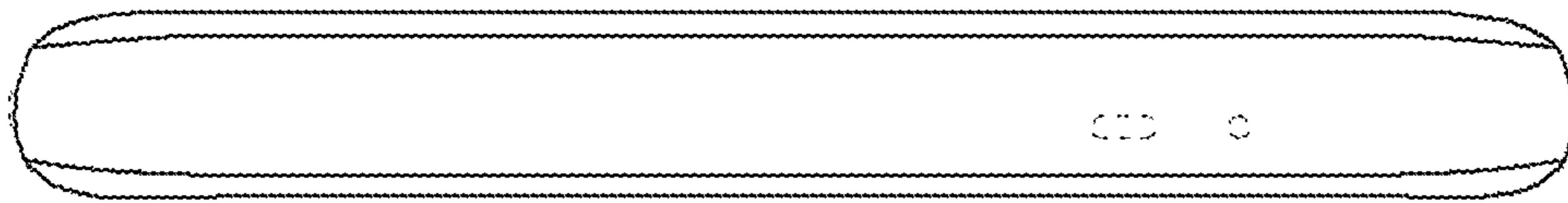

1.7

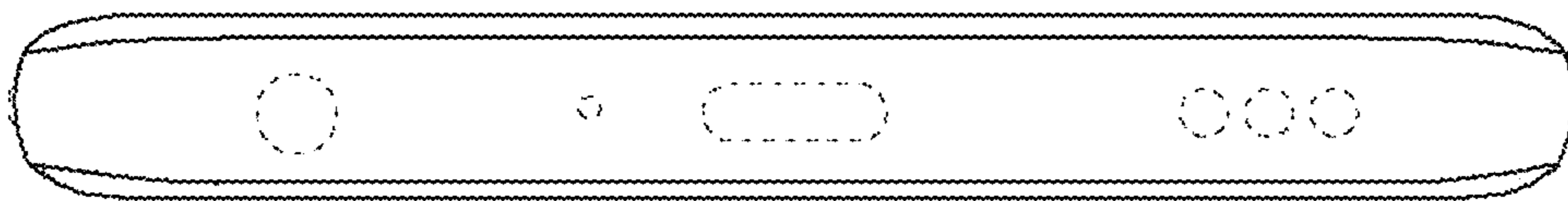

1.8

