



US00D915256S

(12) **United States Design Patent**
Dellemann et al.

(10) **Patent No.:** **US D915,256 S**
(45) **Date of Patent:** **** Apr. 6, 2021**

- (54) **OPERATOR INTERFACE**
- (71) Applicants: **ZOOMLION Heavy Industry NA, Inc.**, Yorkville, WI (US); **ZOOMLION Heavy Industry Science and Technology Co. Ltd.**, Changsha Hunan Province (CN)
- (72) Inventors: **Robert Dellemann**, Yorkville, WI (US); **Shu Wang**, Yorkville, WI (US)
- (73) Assignees: **ZOOMLION HEAVY INDUSTRY NA, INC.**, Yorkville, WI (US); **ZOOMLION HEAVY INDUSTRY SCIENCE AND TECHNOLOGY CO. LTD**

| | | | |
|---------------|---------|-----------------|-----------------------|
| D288,200 S * | 2/1987 | Stoddard | D14/157 |
| D357,024 S * | 4/1995 | Tokiyama | D14/258 |
| D363,060 S * | 10/1995 | Hunger | D13/177 |
| D372,010 S * | 7/1996 | Pfeiffer | D12/192 |
| D374,535 S * | 10/1996 | Feider | D34/35 |
| D376,244 S * | 12/1996 | Feider | D12/192 |
| D382,569 S * | 8/1997 | Esposito | D15/28 |
| D417,201 S * | 11/1999 | Davis | D10/65 |
| D419,936 S * | 2/2000 | Sacco | D12/192 |
| 6,039,141 A * | 3/2000 | Denny | B60N 2/797 180/329 |
| D432,963 S * | 10/2000 | Meinhardt | D12/192 |
| D439,211 S * | 3/2001 | Pfeiffer | D12/192 |
| D444,750 S * | 7/2001 | Meinhardt | D12/192 |
| D486,135 S * | 2/2004 | Hori | D14/157 |

(Continued)

Primary Examiner — Marie D. Fast Horse

(74) *Attorney, Agent, or Firm* — Donald J. Ersler

(**) Term: **15 Years**

(21) Appl. No.: **29/701,230**

(22) Filed: **Aug. 9, 2019**

(51) **LOC (13) Cl.** **12-16**

(52) **U.S. Cl.**
USPC **D12/192; D15/28**

(58) **Field of Classification Search**
USPC D14/388, 389, 390, 318, 439, 443, 399,
D14/336, 341, 342, 346, 356, 130, 218,
D14/454, 455, 299, 371, 374, 378, 496,
D14/432, 434, 457, 458, 257, 258, 157;
D13/162, 164, 168, 182; D8/330, 331;
D10/46, 61, 65, 70, 104.1, 106.9, 106.95,
D10/108; D12/192, 174, 415; D15/5,
D15/28, 15; D34/35

CPC G08G 1/096883; G01C 21/16; B60N 2/14;
B60N 2/797

See application file for complete search history.

(56) **References Cited**

U.S. PATENT DOCUMENTS

| | | | |
|--------------|---------|---------------|---------|
| D248,462 S * | 7/1978 | Bell | D12/192 |
| D276,335 S * | 11/1984 | Yoshida | D14/157 |

(57) **CLAIM**

The ornamental design for an operator interface, as shown and described.

DESCRIPTION

FIG. 1 is a front perspective view of an operator interface incorporating our new design;
FIG. 2 is a top plan view thereof;
FIG. 3 is a bottom plan view thereof;
FIG. 4 is a left side view thereof;
FIG. 5 is a right side view thereof; and,
FIG. 6 is a front view thereof.

The broken lines showing the key and key-ring depict environmental structure and form no part of the claim; the broken lines showing the icons and two dimensional images on the front surfaces depict unclaimed surface indicia are for illustrative purposes only and form no part of the claimed design; while all other broken lines in the drawings depict portions of the operator interface that form no part of the claimed design.

1 Claim, 4 Drawing Sheets

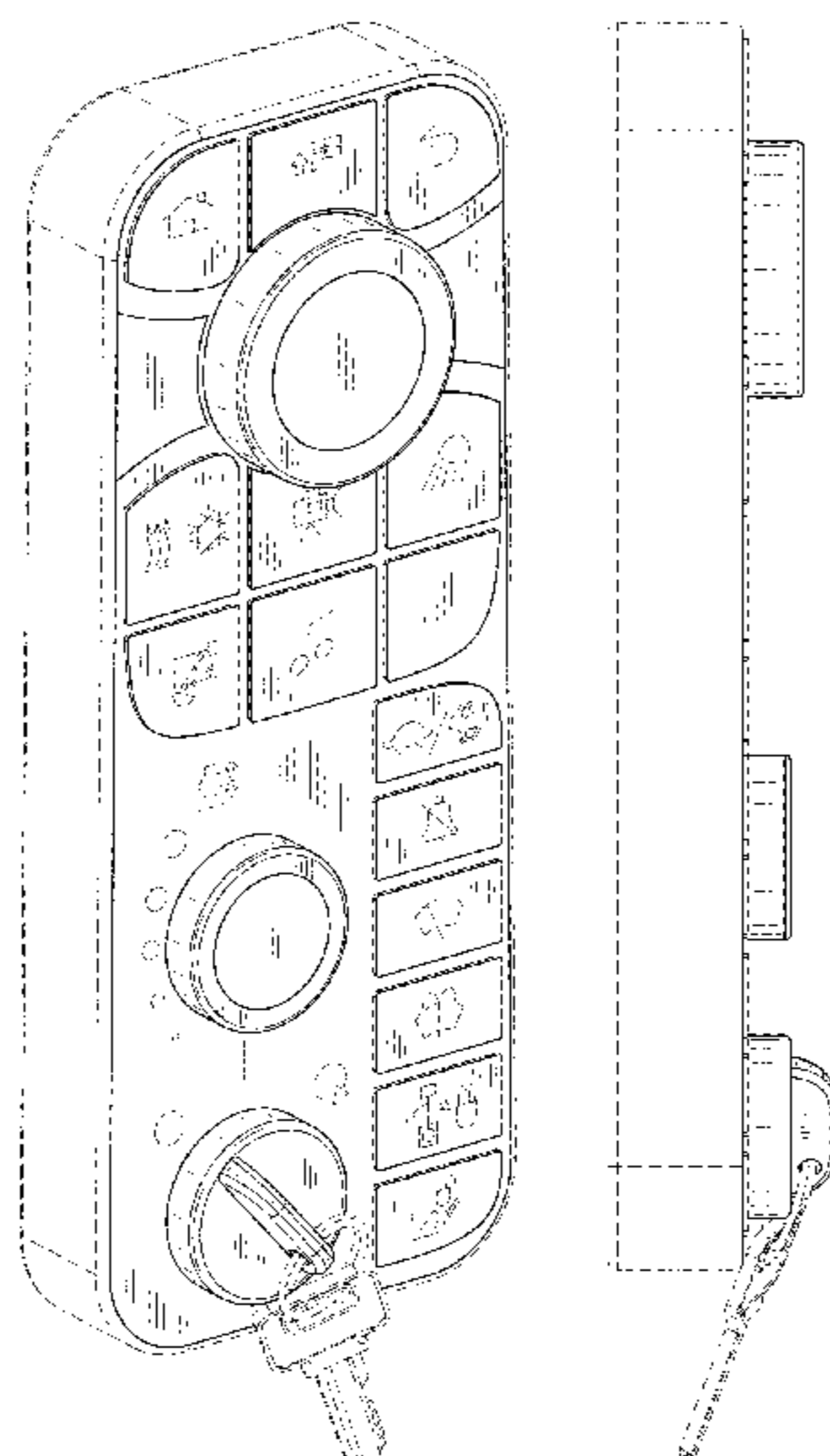

(56)

References Cited

U.S. PATENT DOCUMENTS

D491,555 S * 6/2004 Preissner D14/224
 D492,632 S * 7/2004 Pfeiffer D12/192
 D494,907 S * 8/2004 Pfeiffer D12/192
 D494,909 S * 8/2004 Pfeiffer D12/192
 D503,367 S * 3/2005 Pfeiffer D12/192
 D504,372 S * 4/2005 Juraschek D12/192
 D519,132 S * 4/2006 Laux D15/28
 D525,409 S * 7/2006 Cantrill D12/192
 D529,848 S * 10/2006 Shigehara D12/192
 D535,926 S * 1/2007 Anderson D12/192
 D541,795 S * 5/2007 Kimura D14/258
 D544,468 S * 6/2007 Anandpura D14/218
 D561,077 S * 2/2008 Kato D12/192
 D561,755 S * 2/2008 Riede D14/257
 D563,624 S * 3/2008 Kato D34/35
 D564,509 S * 3/2008 Kimura D14/258
 D565,043 S * 3/2008 Shiono D14/258
 D571,348 S * 6/2008 Uehara D14/157
 D571,350 S * 6/2008 Iwamoto D14/157
 D575,212 S * 8/2008 Tsay D12/192
 D578,048 S * 10/2008 Wyszogrod D12/192
 D578,272 S * 10/2008 Kato D15/28
 D578,273 S * 10/2008 Kato D34/35
 D593,989 S * 6/2009 Endo D14/157
 D598,913 S * 8/2009 Brown D14/341
 D602,931 S * 10/2009 Kaner D12/192
 D603,316 S * 11/2009 Wolfe D12/192
 D603,367 S * 11/2009 Shimizu D14/157
 D604,287 S * 11/2009 Kimura D14/157
 D611,059 S * 3/2010 Sugita D14/505
 D611,361 S * 3/2010 Knight D10/65
 D621,760 S * 8/2010 Wiedeman D12/192

D624,907 S * 10/2010 Komiya D14/247
 D626,902 S * 11/2010 Vermeersch D12/192
 D632,622 S * 2/2011 Fujioka D12/192
 D633,117 S * 2/2011 de la Hamayde D15/146
 D645,464 S * 9/2011 Kimura D14/257
 D649,544 S * 11/2011 Chiu D14/318
 D660,328 S * 5/2012 Doberstein D15/89
 D671,520 S * 11/2012 Kanou D14/157
 D672,379 S * 12/2012 de la Hamayde D15/146
 D672,743 S * 12/2012 Suzuki D14/157
 D680,094 S * 4/2013 Kanou D14/157
 D682,261 S * 5/2013 Miyawaki D14/258
 D704,698 S * 5/2014 Morikawa D14/258
 D705,212 S * 5/2014 Murakami D14/258
 D721,996 S * 2/2015 Farcas D12/192
 D744,975 S * 12/2015 Kimura D14/258
 D751,963 S * 3/2016 McConnell D12/192
 D752,492 S * 3/2016 McConnell D12/192
 D760,182 S * 6/2016 Zhu D14/157
 D760,814 S * 7/2016 Ewringmann D15/28
 D775,121 S * 12/2016 Suzuki D14/258
 D789,425 S * 6/2017 Smith D15/28
 D793,931 S * 8/2017 Lee D12/192
 D794,538 S * 8/2017 Ahn D12/415
 D817,320 S * 5/2018 Choe D14/258
 D825,418 S * 8/2018 Cadalora D12/177
 D826,117 S * 8/2018 Cadalora D12/177
 D838,713 S * 1/2019 Muramoto D14/258
 D860,119 S * 9/2019 Kang D12/415
 D860,121 S * 9/2019 Kang D12/415
 D860,124 S * 9/2019 Kang D12/415
 D862,365 S * 10/2019 Kang D12/415
 D871,311 S * 12/2019 TenBrink D12/415
 D906,944 S * 1/2021 Velet B64D 11/0626
 D12/415

* cited by examiner

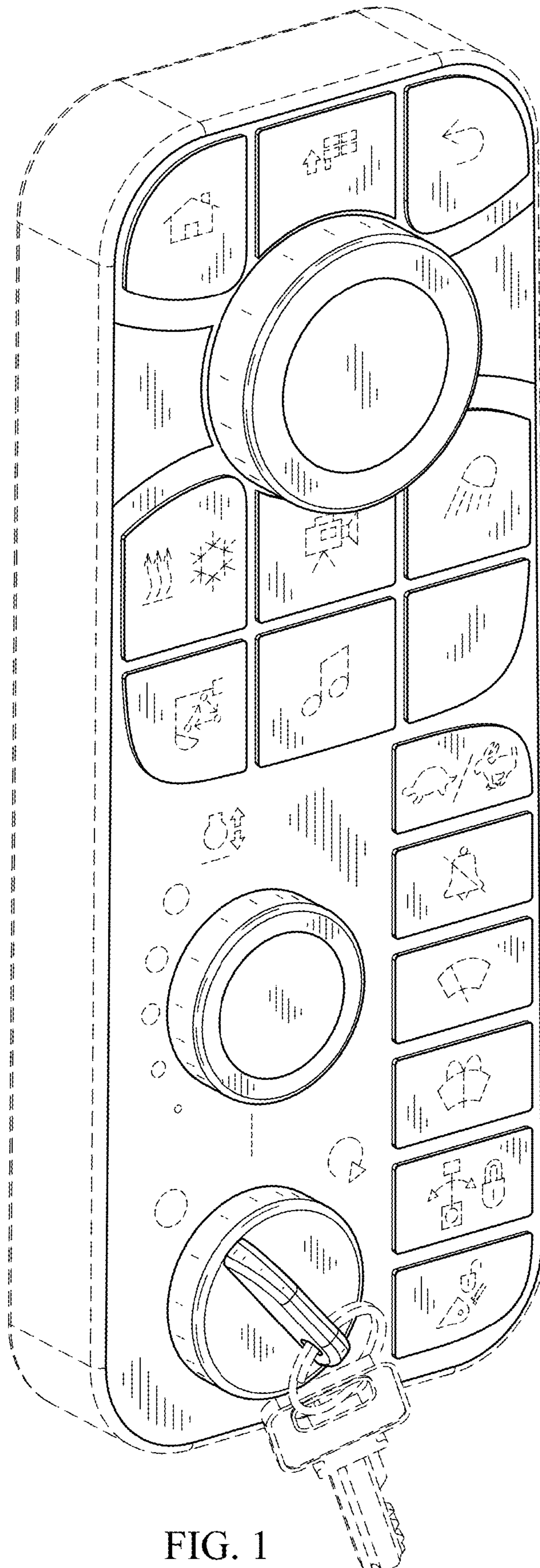

FIG. 1

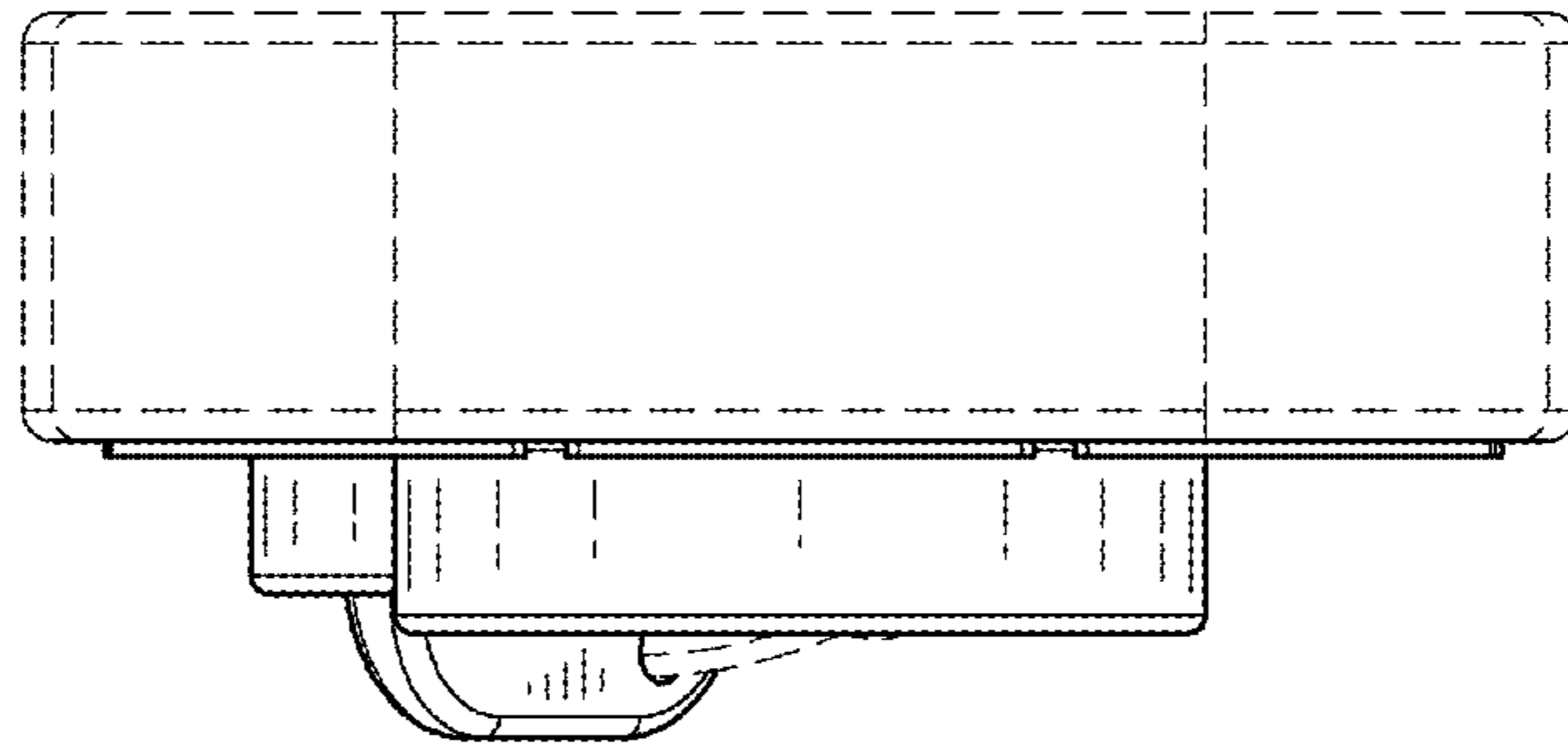

FIG. 2

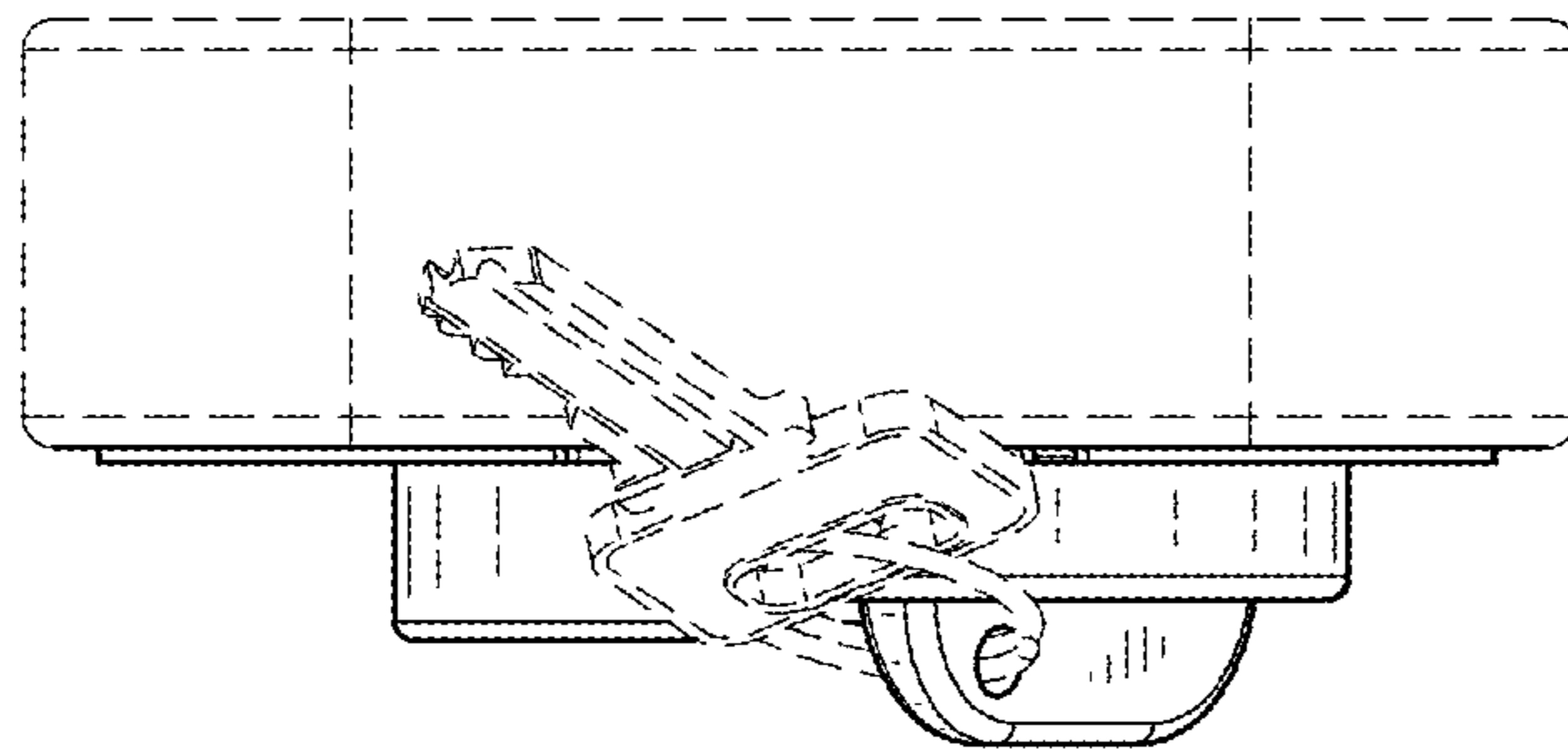

FIG. 3

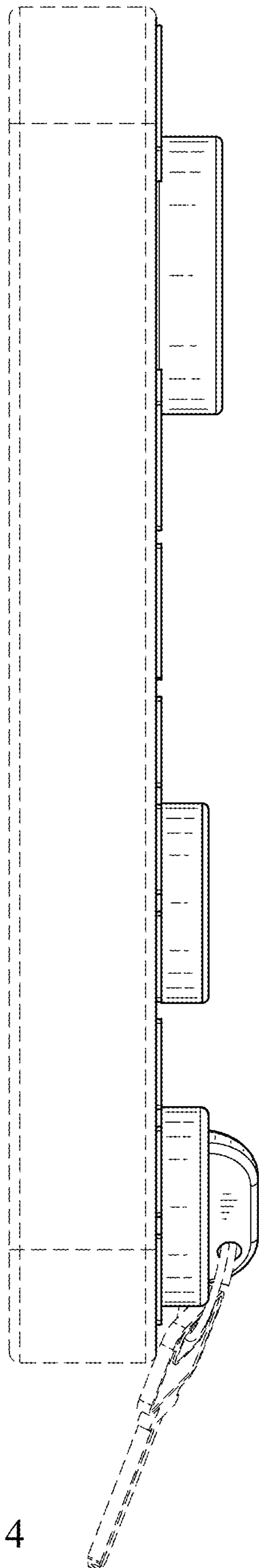

FIG. 4

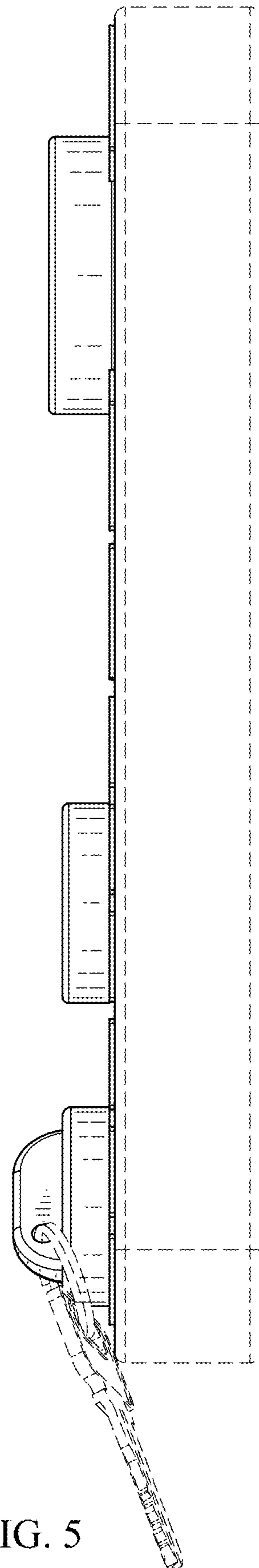

FIG. 5

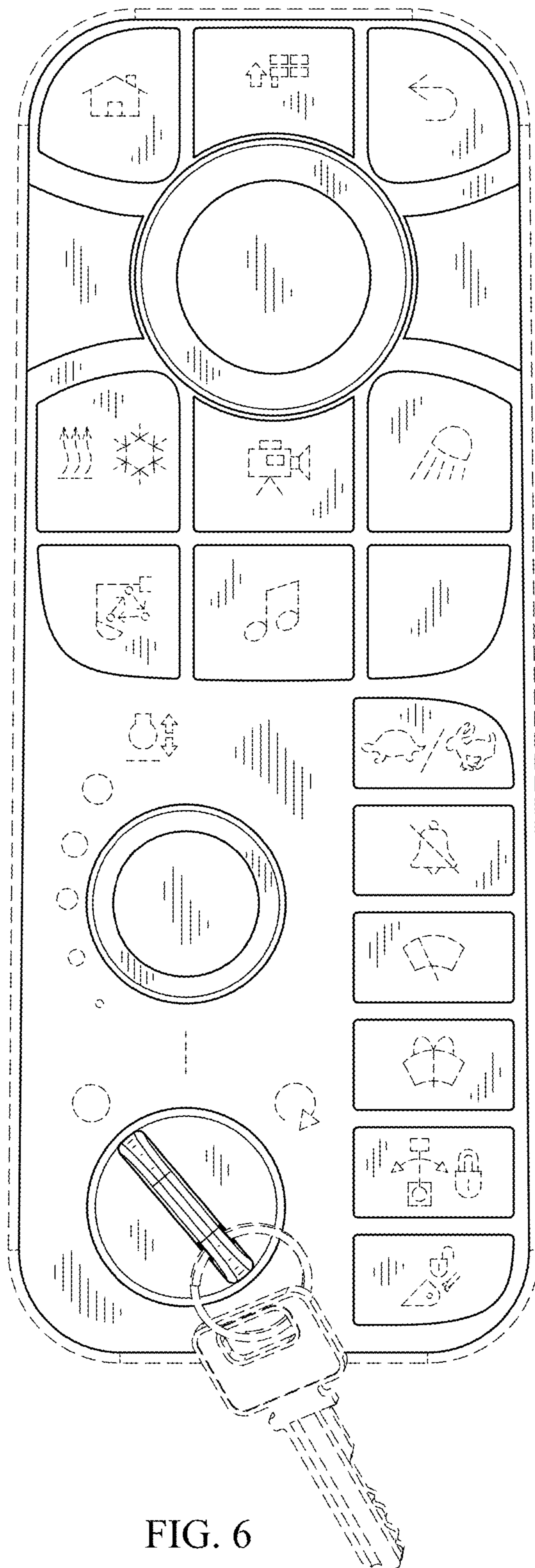

FIG. 6