



US00D915171S

(12) **United States Design Patent** (10) **Patent No.:** **US D915,171 S**  
**Zhu** (45) **Date of Patent:** **\*\* Apr. 6, 2021**

- (54) **SILICONE THUMB KNIFE**
- (71) Applicant: **HUIZHOU HESHENG AGRICULTURAL MACHINERY CO., LTD., Huizhou (CN)**
- (72) Inventor: **Chengbao Zhu, Huizhou (CN)**
- (73) Assignee: **HUIZHOU HESHENG AGRICULTURAL MACHINERY CO., LTD., Huizhou (CN)**
- (\*\*) Term: **15 Years**
- (21) Appl. No.: **29/719,731**
- (22) Filed: **Jan. 7, 2020**
- (51) **LOC (13) Cl.** ..... **08-03**
- (52) **U.S. Cl.**  
USPC ..... **D8/98**
- (58) **Field of Classification Search**  
USPC ..... D8/14, 98, 99, 100; D24/133; D22/118;  
D29/114; D3/29  
CPC ..... B26B 27/00; B26B 27/007  
See application file for complete search history.

- D690,568 S \* 10/2013 Macedo ..... D8/45
- D695,004 S \* 12/2013 Lee ..... D3/29
- D696,006 S \* 12/2013 Lee ..... D3/29
- D732,901 S 6/2015 Shahani
- D757,505 S 5/2016 Wegwerth
- D833,231 S 11/2018 Simha
- D869,258 S 12/2019 Ulloa
- D871,137 S 12/2019 Brouillac
- D876,813 S \* 3/2020 Hu ..... D3/29
- 2004/0231167 A1 \* 11/2004 Miklos ..... B26B 27/007  
30/298
- 2010/0229318 A1 \* 9/2010 Sparks ..... B08B 1/00  
15/236.01
- 2010/0271339 A1 \* 10/2010 Helm ..... G06F 3/033  
345/179
- 2012/0304471 A1 \* 12/2012 Jones ..... B26B 5/001  
30/162
- 2016/0286910 A1 \* 10/2016 Fisher ..... B26B 27/007

\* cited by examiner

*Primary Examiner* — Philip S Hyder  
(74) *Attorney, Agent, or Firm* — Law Offices of Steven W. Weinrieb

(57) **CLAIM**  
The ornamental design for a silicone thumb knife, as shown and described.

- (56) **References Cited**  
U.S. PATENT DOCUMENTS
- 2,847,012 A \* 8/1958 Eastman ..... A61B 17/4208  
606/125
- 4,339,878 A \* 7/1982 Tozzi ..... B26B 27/007  
30/291
- 6,027,511 A \* 2/2000 Shirley ..... A61B 17/4208  
606/119
- D422,121 S \* 3/2000 Peck ..... D29/114
- D484,769 S 1/2004 Cheung
- D498,588 S \* 11/2004 de Baschmakoff ..... D3/243
- D565,381 S 4/2008 Wu
- 7,503,120 B2 \* 3/2009 Williams ..... B26B 27/007  
30/165
- D653,813 S \* 2/2012 Rogers ..... D29/114

**DESCRIPTION**  
FIG. 1 is a front, right side, top perspective view of a silicone thumb knife showing my new design;  
FIG. 2 is a rear, left side, bottom perspective view thereof;  
FIG. 3 is a front elevational view thereof;  
FIG. 4 is a rear elevational view thereof;  
FIG. 5 is a left side elevational view thereof;  
FIG. 6 is a right side elevational view thereof;  
FIG. 7 is a top plan view thereof; and,  
FIG. 8 is a bottom plan view thereof.  
The broken lines depict portions of the silicone thumb knife that form no part of the claimed design.

**1 Claim, 8 Drawing Sheets**

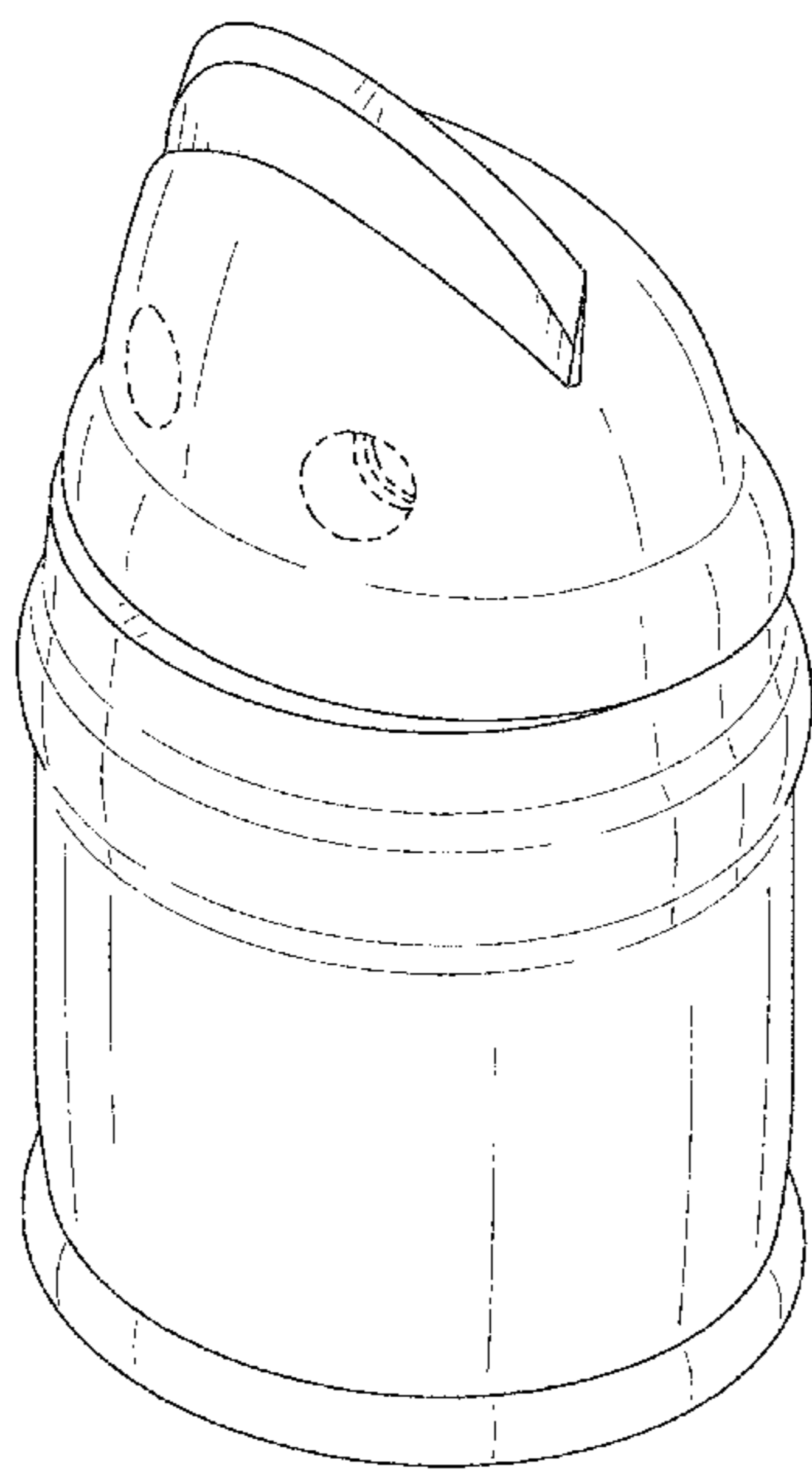

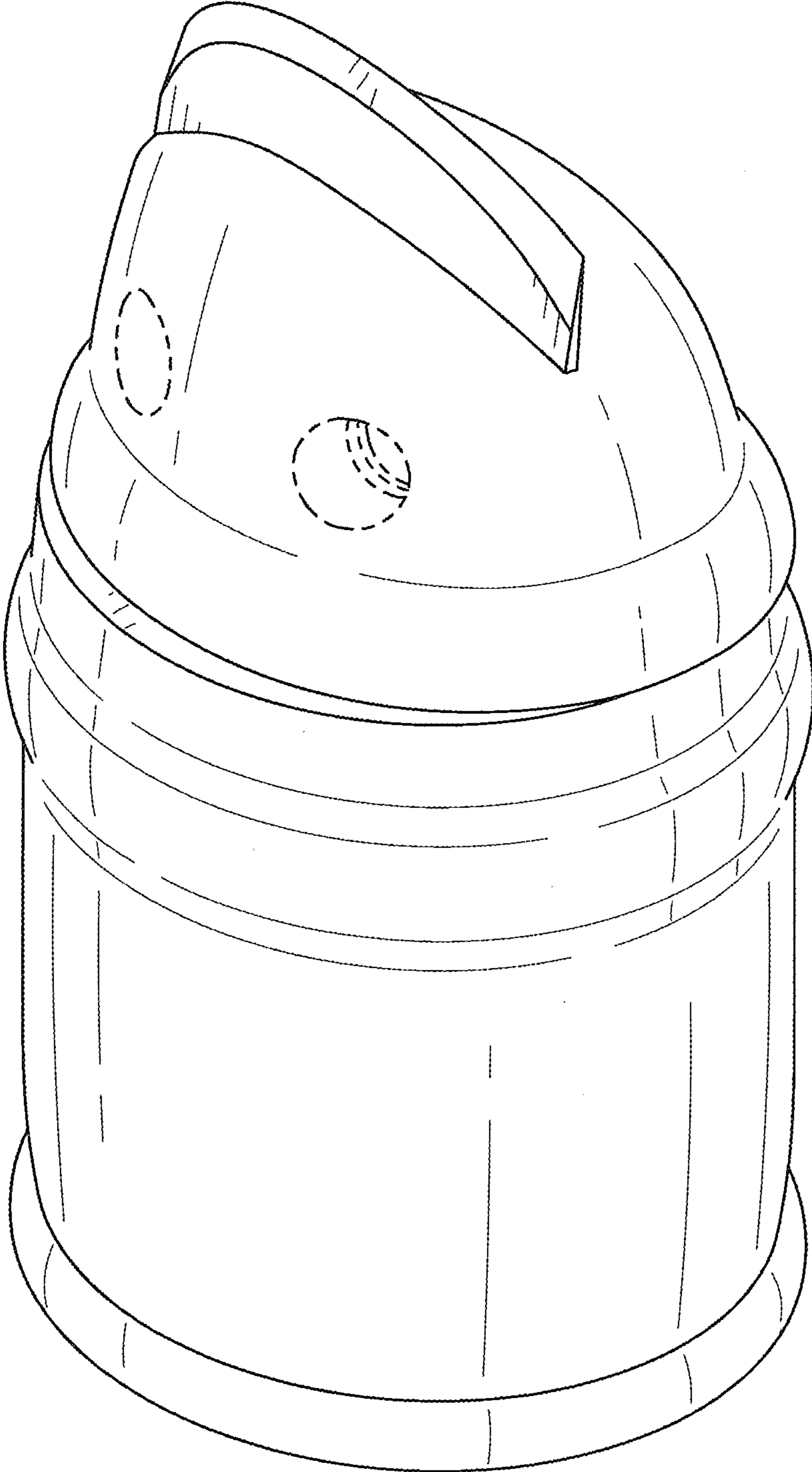

FIG. 1

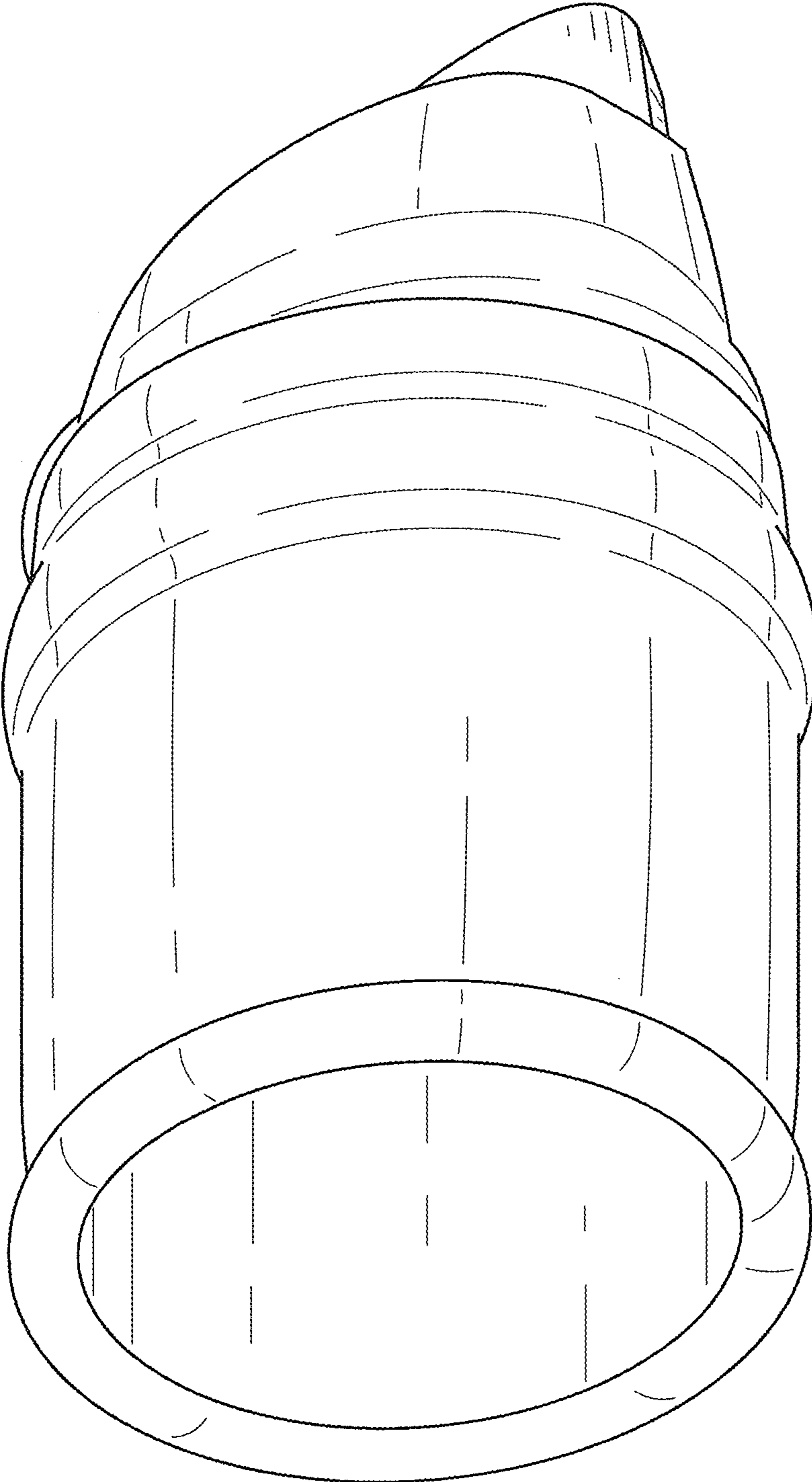

FIG. 2

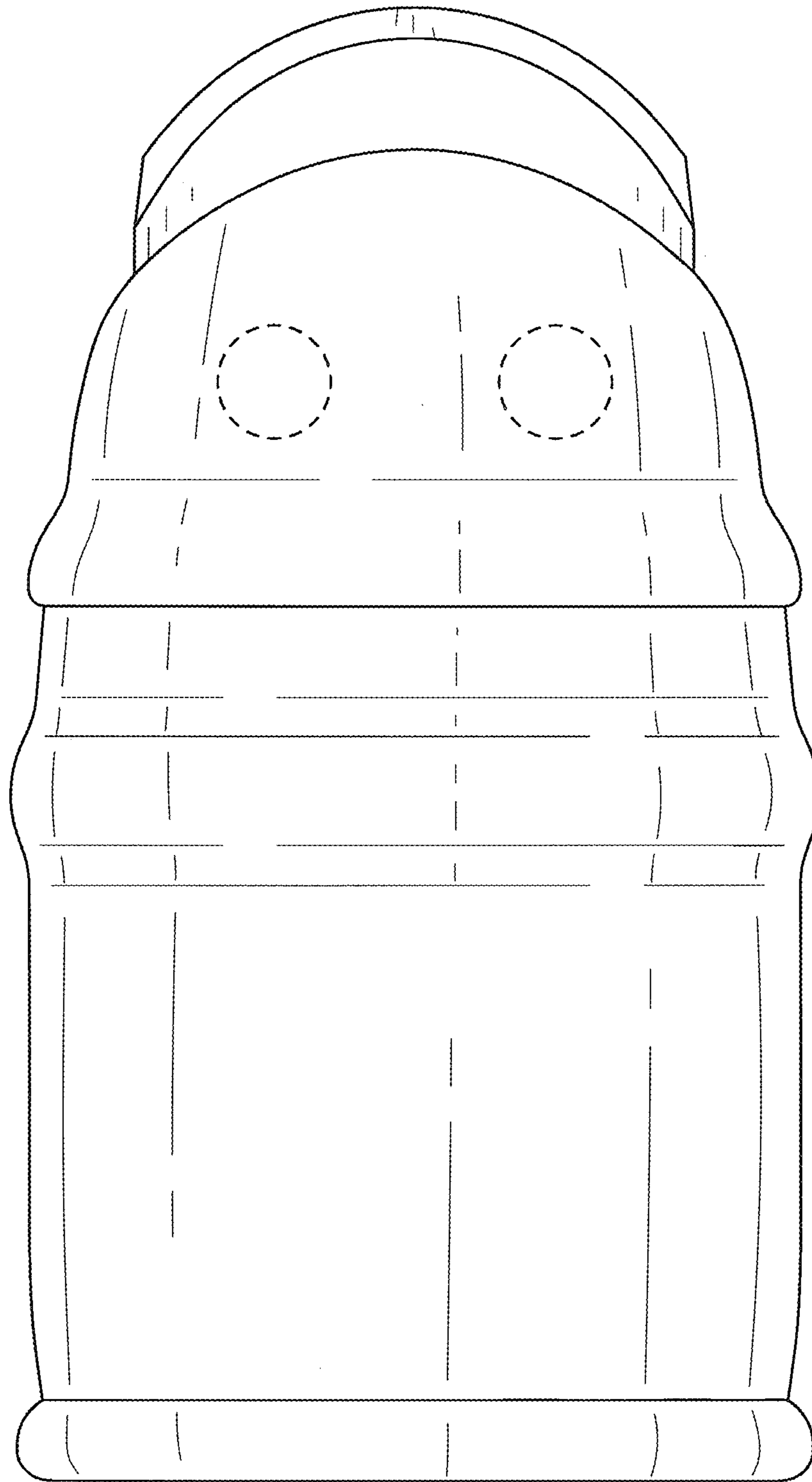

FIG. 3

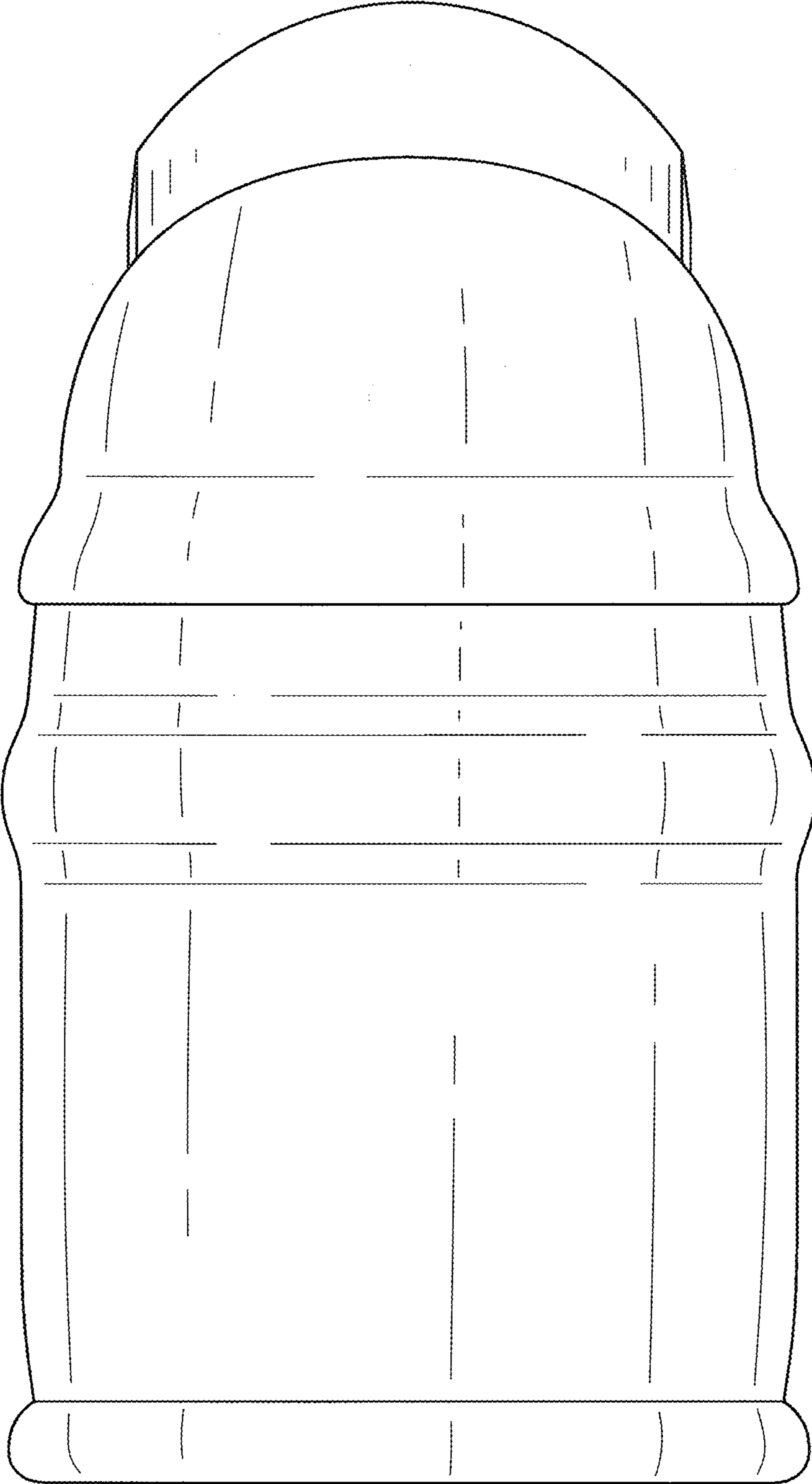

FIG. 4

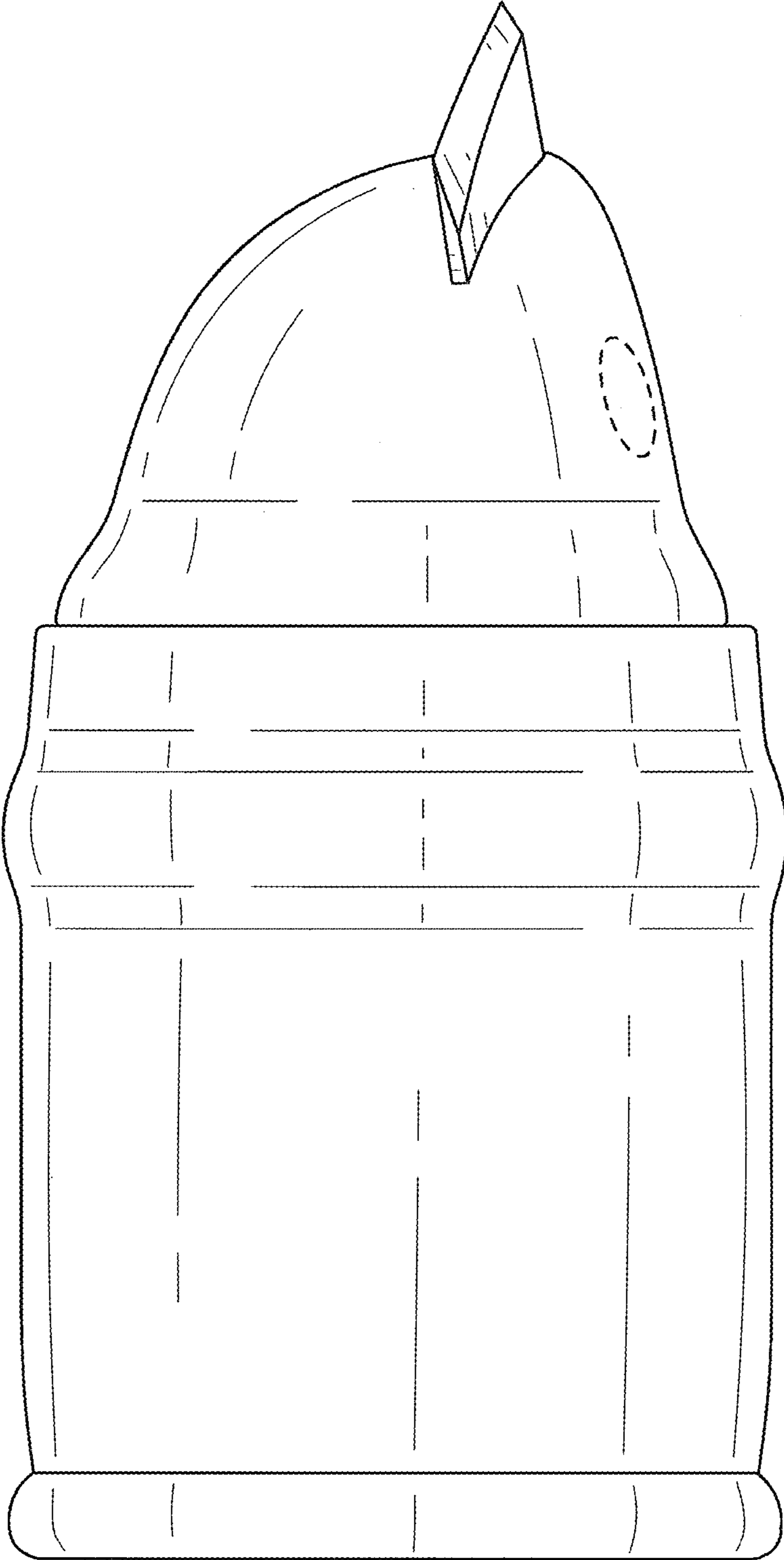

FIG. 5



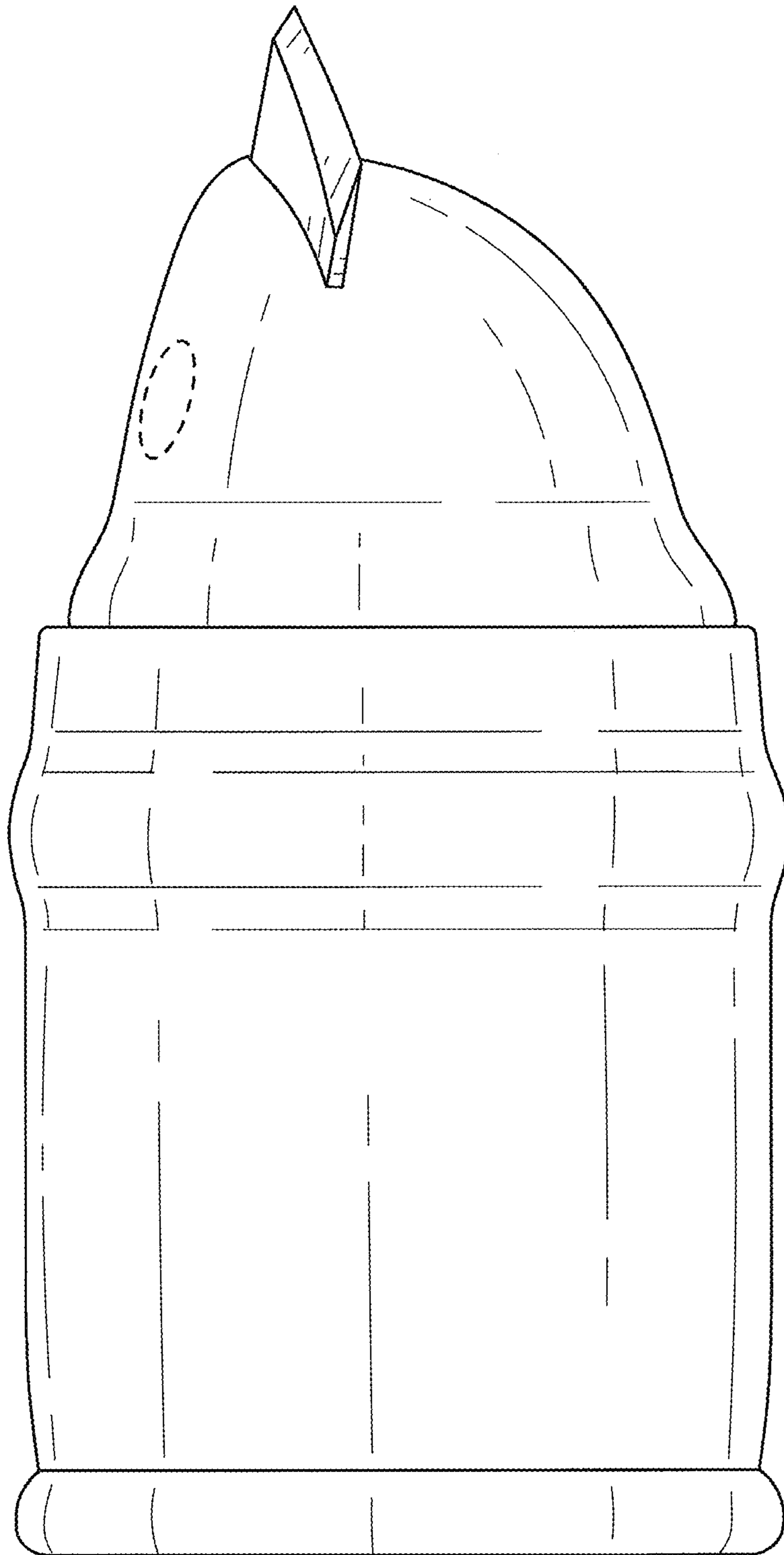

FIG. 6

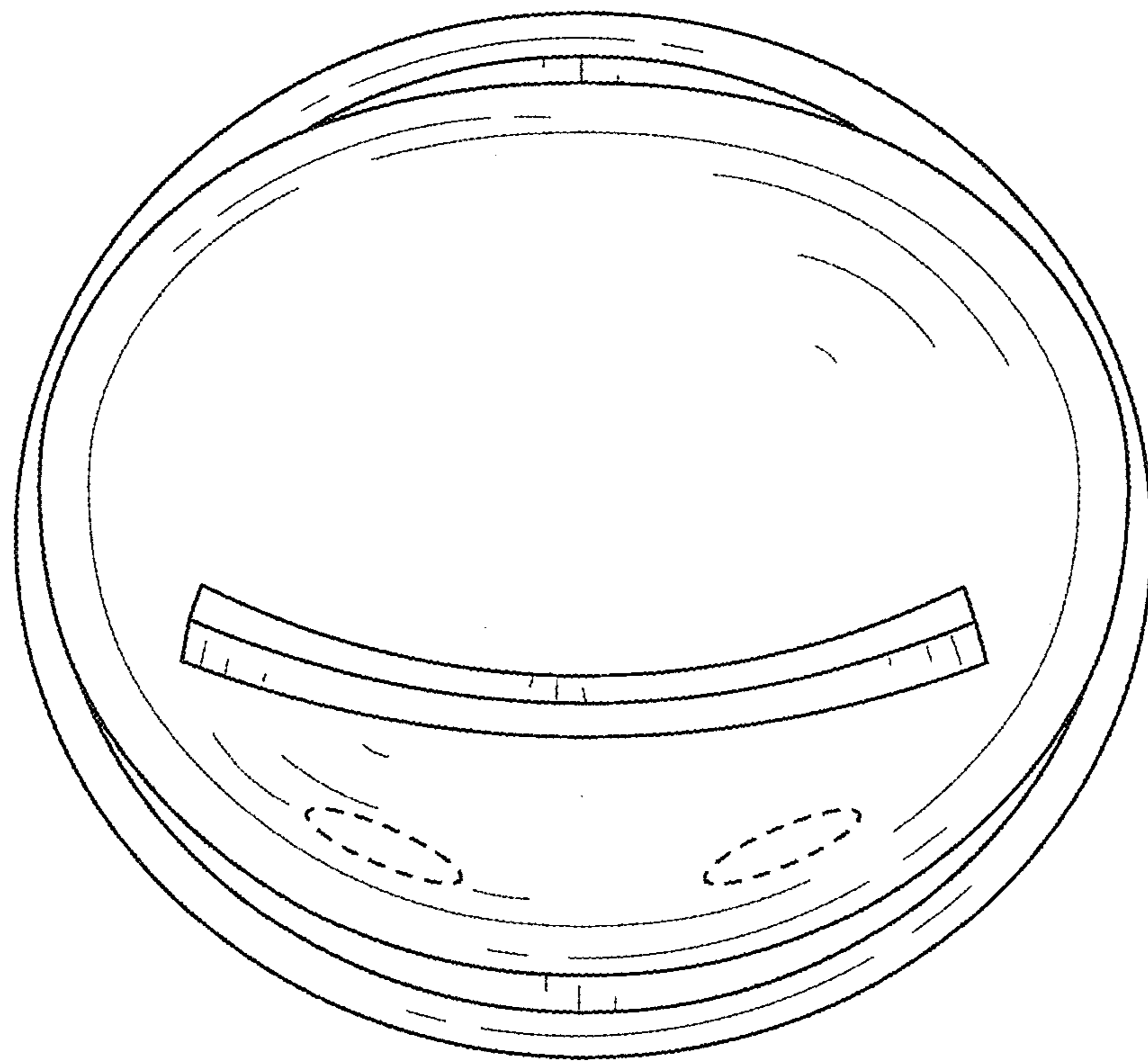

FIG. 7



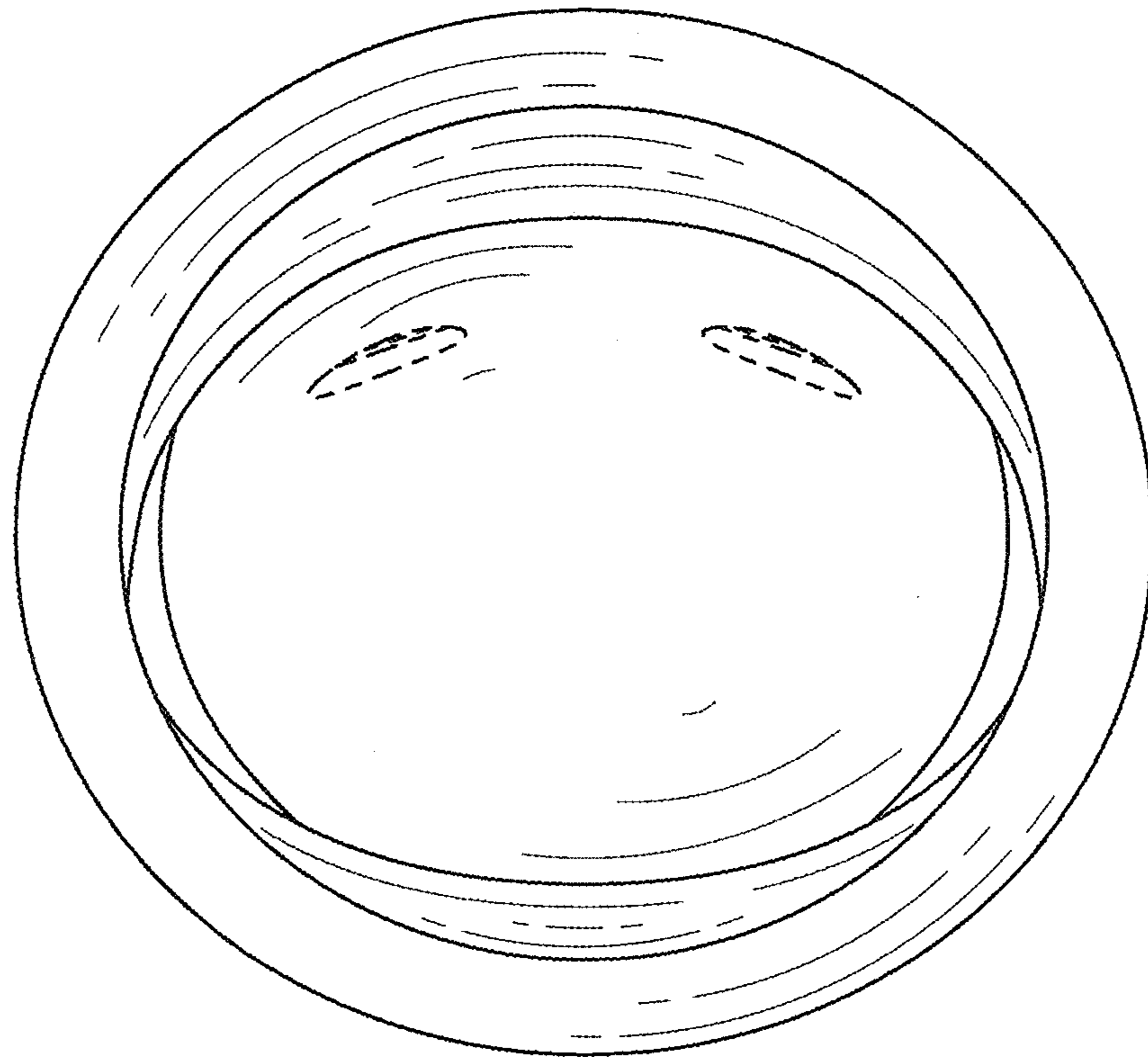

FIG. 8