



US00D915109S

(12) **United States Design Patent**
Sharp

(10) **Patent No.:** **US D915,109 S**

(45) **Date of Patent:** **** Apr. 6, 2021**

(54) **STORAGE LOCKER DRAWER**

(71) Applicant: **Harbor Freight Tools USA, Inc.**,
Calabasas, CA (US)

(72) Inventor: **William Thomas Sharp**, Camarillo,
CA (US)

(73) Assignee: **Harbor Freight Tools USA, INC.**,
Calabasas, CA (US)

(**) Term: **15 Years**

(21) Appl. No.: **29/705,341**

(22) Filed: **Sep. 11, 2019**

(51) **LOC (13) Cl.** **06-06**

(52) **U.S. Cl.**
USPC **D6/705.5; D6/705**

(58) **Field of Classification Search**
USPC D6/663, 664, 664.1, 667, 671, 671.1,
D6/671.2, 671.3, 671.4, 705, 705.1,
D6/705.2, 705.4, 705.5; D3/295, 296,
D3/297, 298
CPC A47B 17/04; A47B 47/00; A47B 47/04;
A47B 57/00; A47B 67/00; A47B 67/04;
A47B 88/00; A47B 88/40; A47B 88/42;
A47B 88/402; A47B 88/407; A47B
88/413; A47B 88/417; A47B 88/433;
A47B 88/90; A47B 88/906; A47B
88/944; A47B 88/994; A47B 63/02; B62B
3/006

See application file for complete search history.

(56) **References Cited**

U.S. PATENT DOCUMENTS

565,703 A * 8/1896 Stolzer A47B 88/90
312/348.3
D102,424 S * 12/1936 Gardiner D6/671.1

3,032,381 A * 5/1962 Boro A47B 88/994
312/111
3,316,046 A * 4/1967 Stephens A47B 63/02
312/246
3,537,770 A * 11/1970 Evans A47B 88/90
312/294

(Continued)

Primary Examiner — Mimosa De

(74) *Attorney, Agent, or Firm* — McAndrews Held &
Malloy, Ltd.

(57) **CLAIM**

The ornamental design for a storage locker drawer, as shown
and described.

DESCRIPTION

FIG. 1 is a top-front perspective view of a storage locker
drawer showing my new design;
FIG. 2 is a front elevation view thereof;
FIG. 3 is a rear elevation thereof;
FIG. 4 is a right side elevation view thereof;
FIG. 5 is a left side elevation view thereof;
FIG. 6 is a top plan view thereof;
FIG. 7 is a bottom plan view thereof;
FIG. 8 is a top-front perspective view thereof, showing the
drawer separately for clarity of illustration;
FIG. 9 is a front elevation view thereof, showing the drawer
separately for clarity of illustration;
FIG. 10 is a rear elevation thereof, showing the drawer
separately for clarity of illustration;
FIG. 11 is a right side elevation view thereof, showing the
drawer separately for clarity of illustration;
FIG. 12 is a left side elevation view thereof, showing the
drawer separately for clarity of illustration;
FIG. 13 is a top plan view thereof, showing the drawer
separately for clarity of illustration; and,
FIG. 14 is a bottom plan view thereof, showing the drawer
separately for clarity of illustration.
The evenly dashed broken lines in the figures illustrate
portions of the storage locker drawer that form no part of the

(Continued)

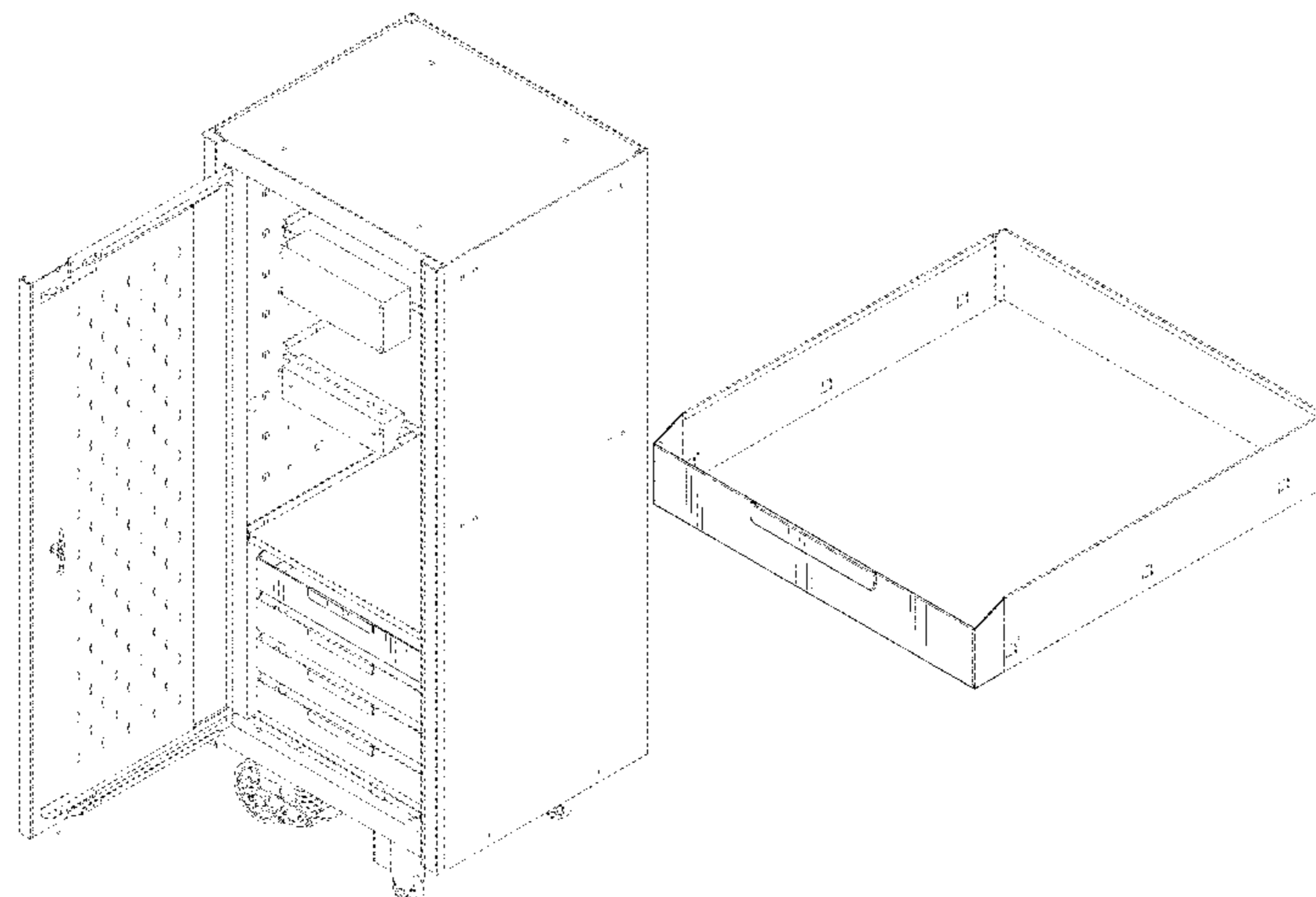

claimed design. The dot-dash broken lines in the drawings illustrate a boundary line that forms no part of the claimed design.

1 Claim, 11 Drawing Sheets

(56)

References Cited

U.S. PATENT DOCUMENTS

D341,737	S	*	11/1993	Shepherd	D6/671.1
5,829,767	A	*	11/1998	Grossman	B62B 3/006
						280/47.35
D458,780	S	*	6/2002	Siepmann	D6/705.5
D477,154	S	*	7/2003	Benn	D3/297
D513,141	S	*	12/2005	Mehmen	D6/705.1
D521,777	S	*	5/2006	Gusdorf	D6/705
D667,234	S	*	9/2012	Maroney	D6/667
D667,658	S	*	9/2012	Maroney	D6/705
D741,624	S	*	10/2015	Freimuth	D6/671.1
D824,193	S	*	7/2018	Poulton	D6/663

* cited by examiner

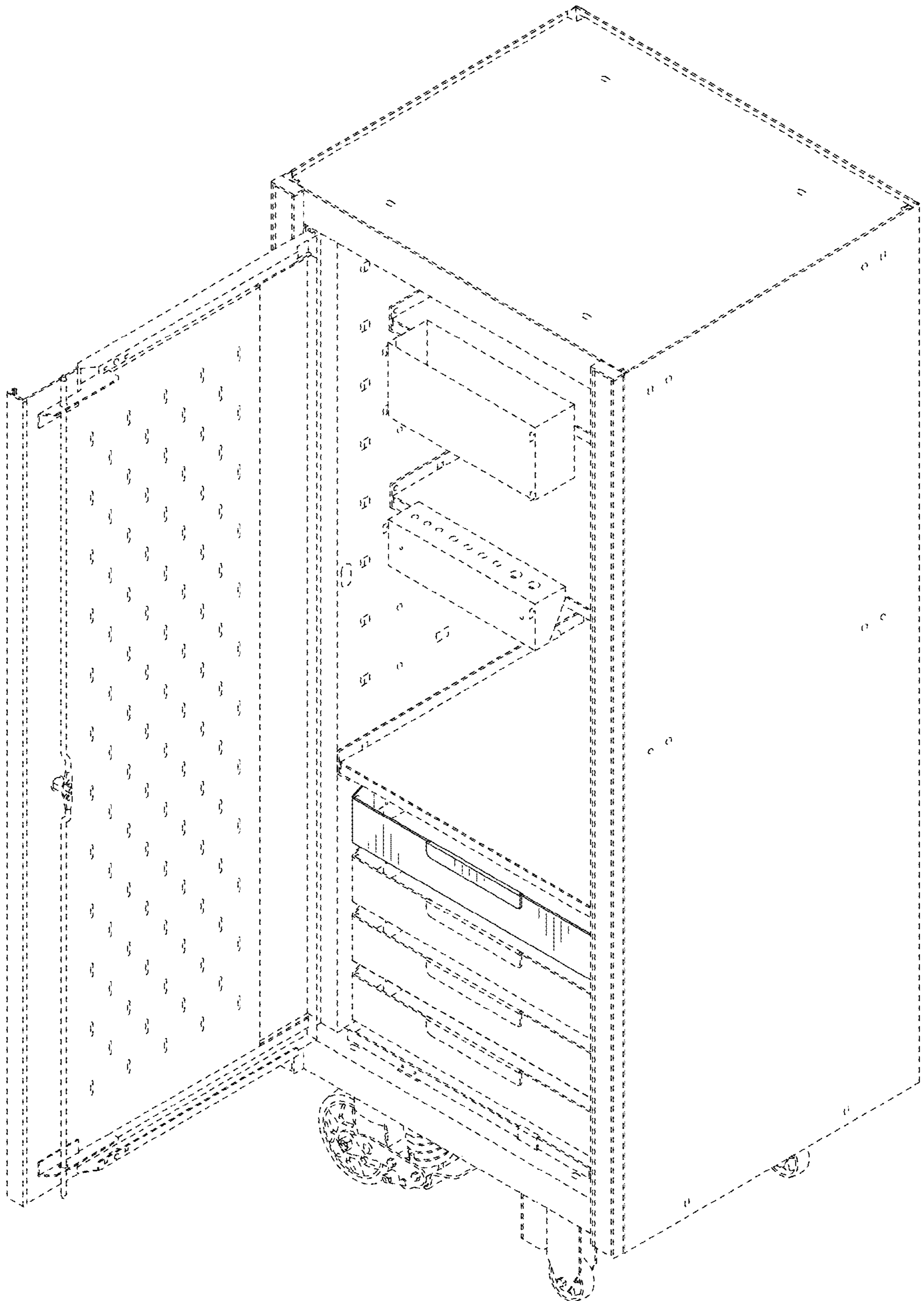

FIG. 1

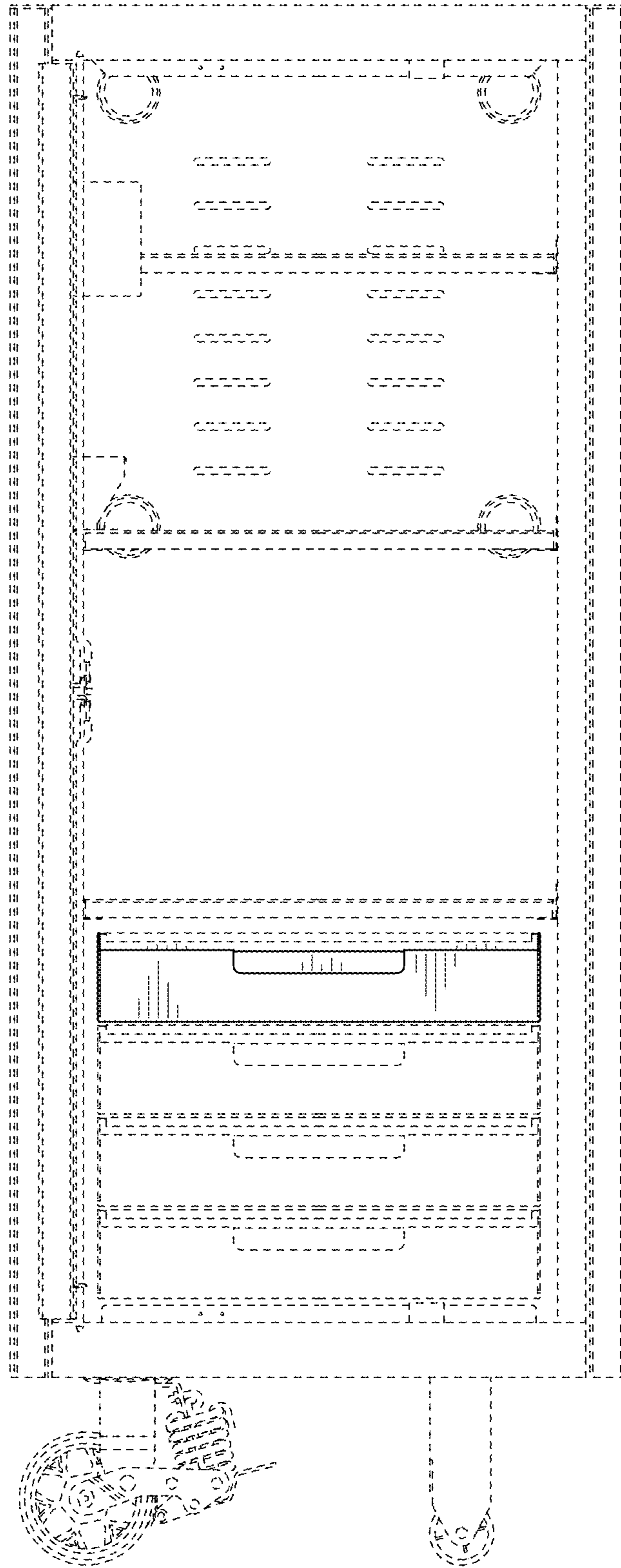

FIG. 2

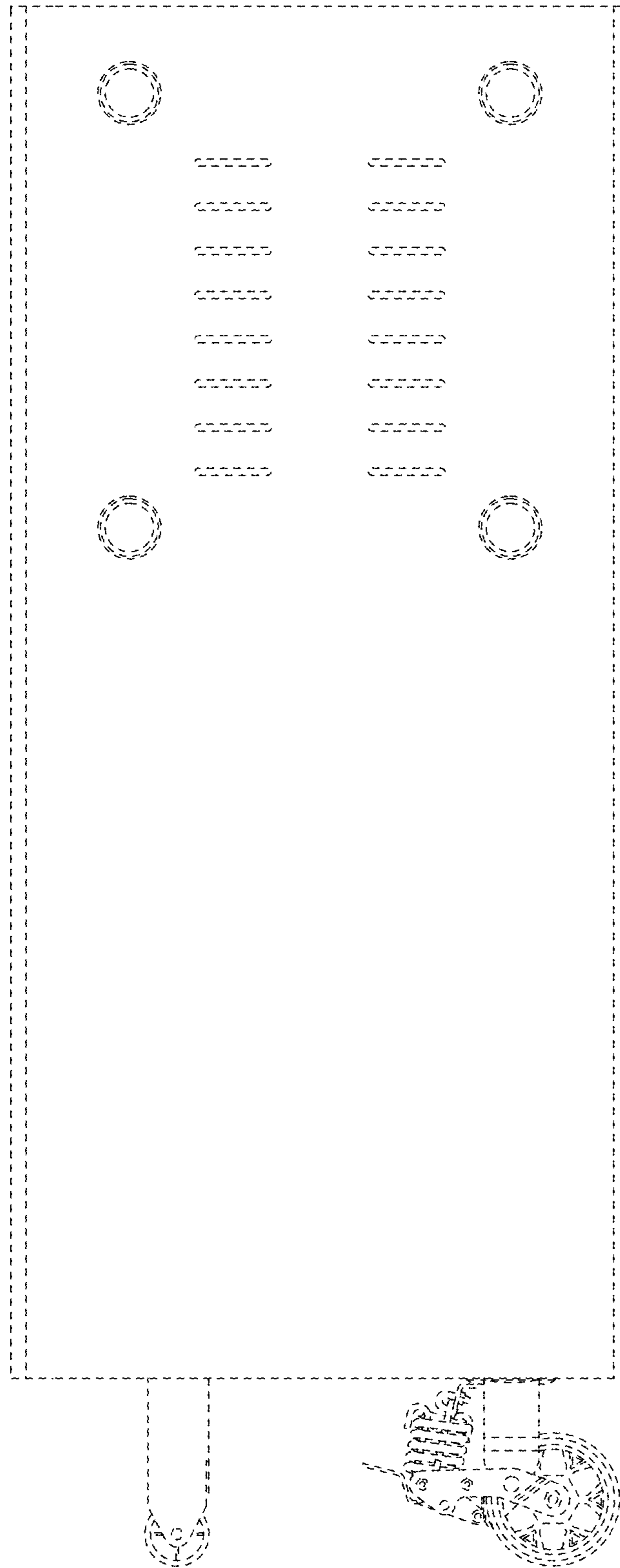

FIG. 3

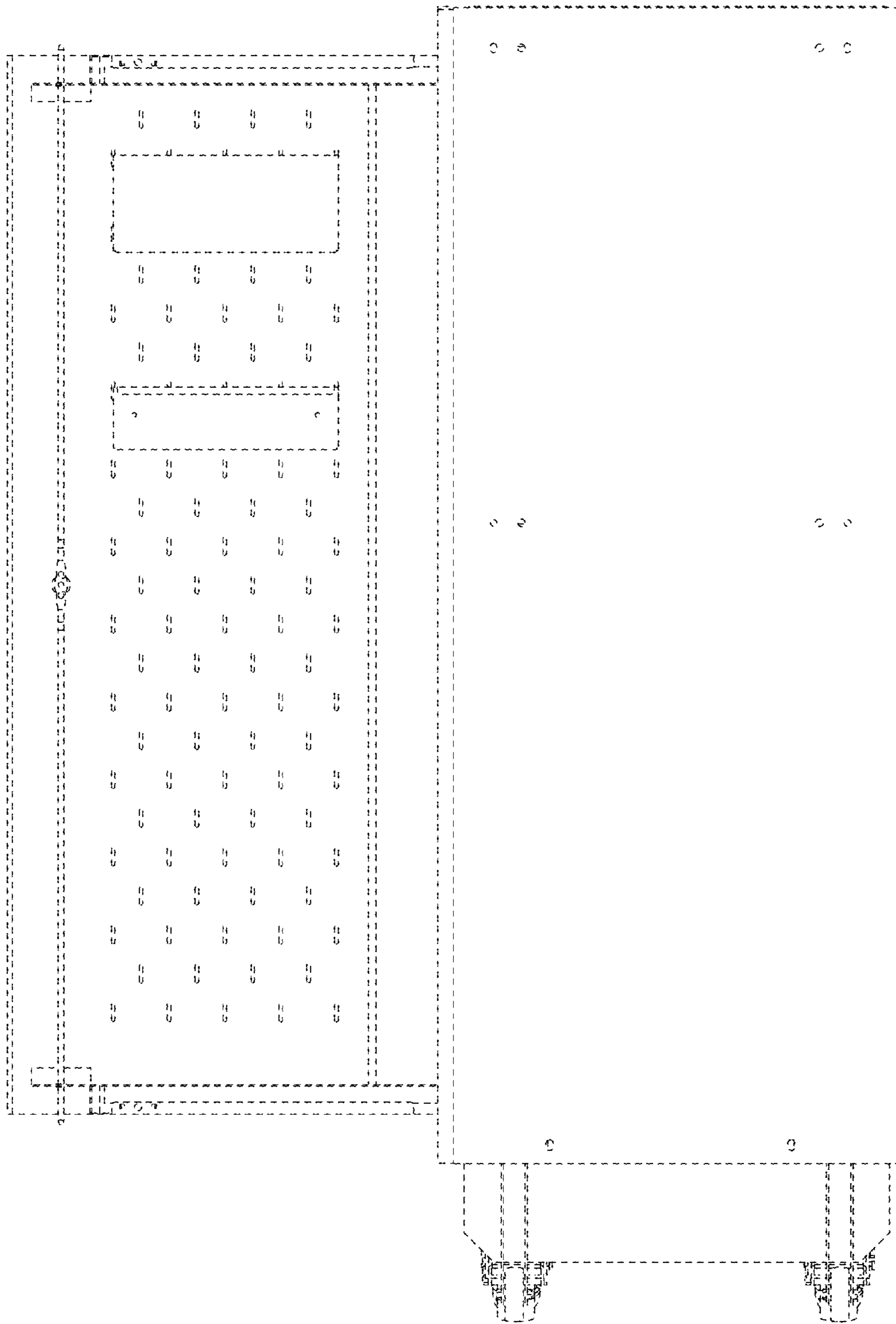

FIG. 4

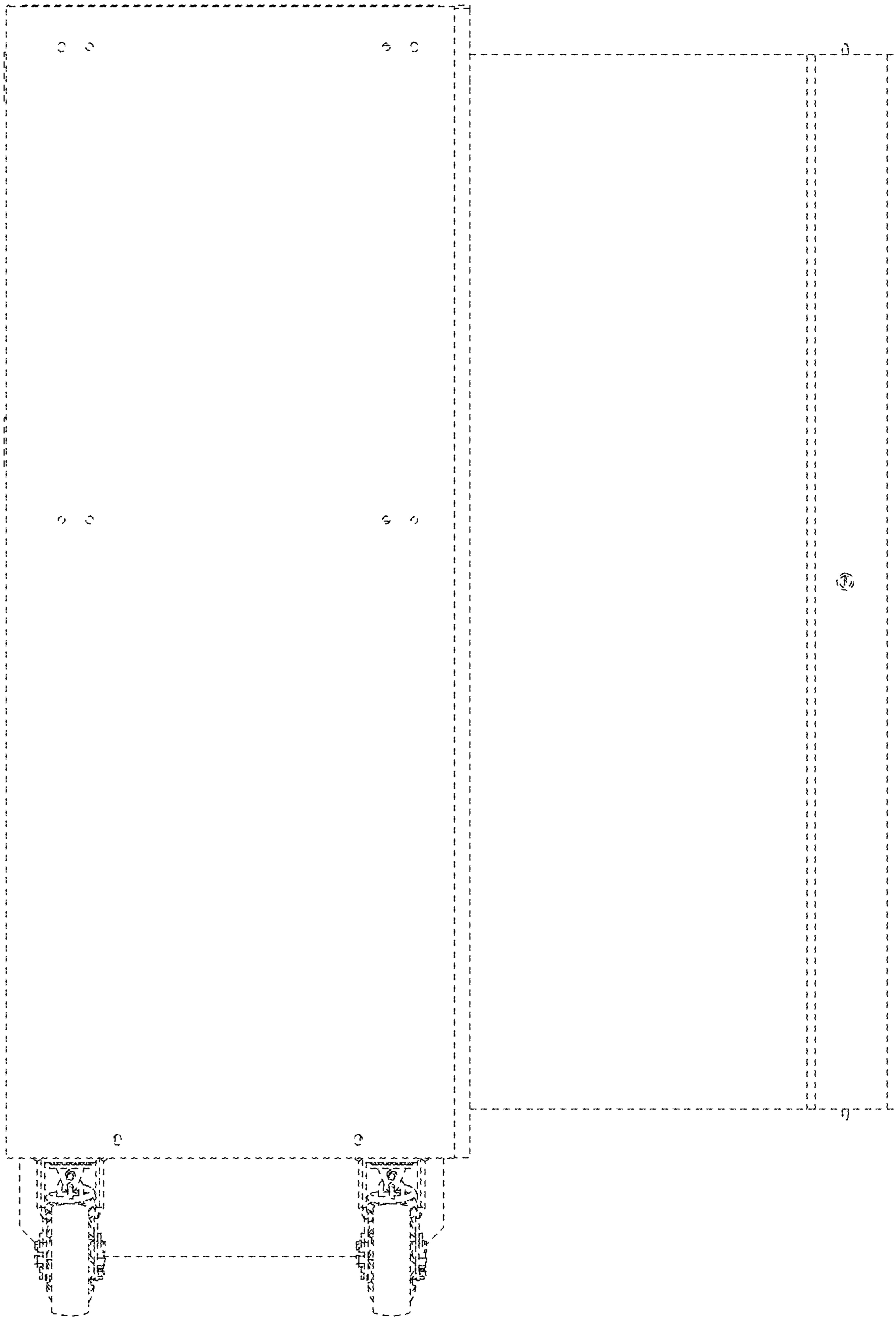

FIG. 5

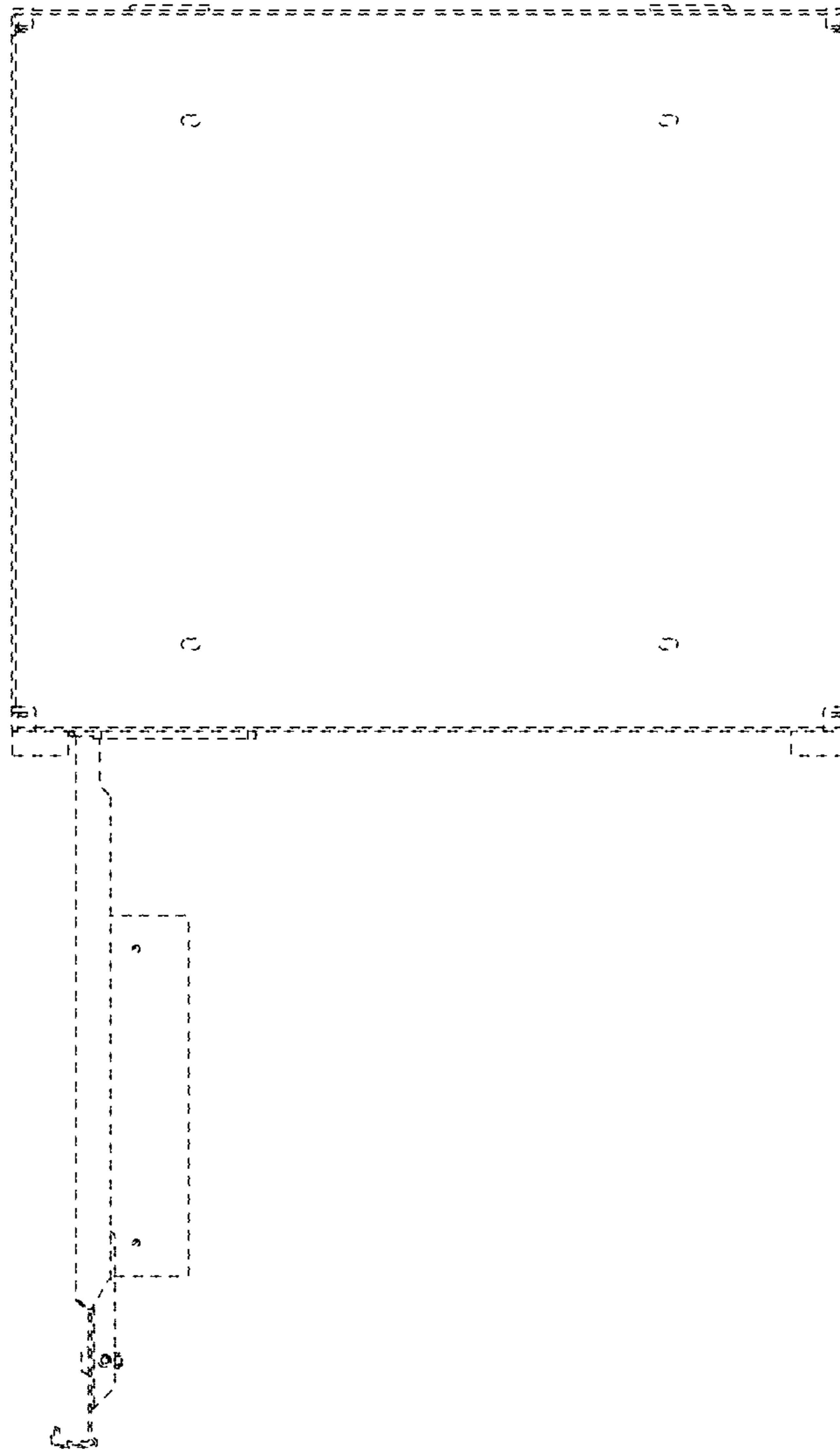

FIG. 6

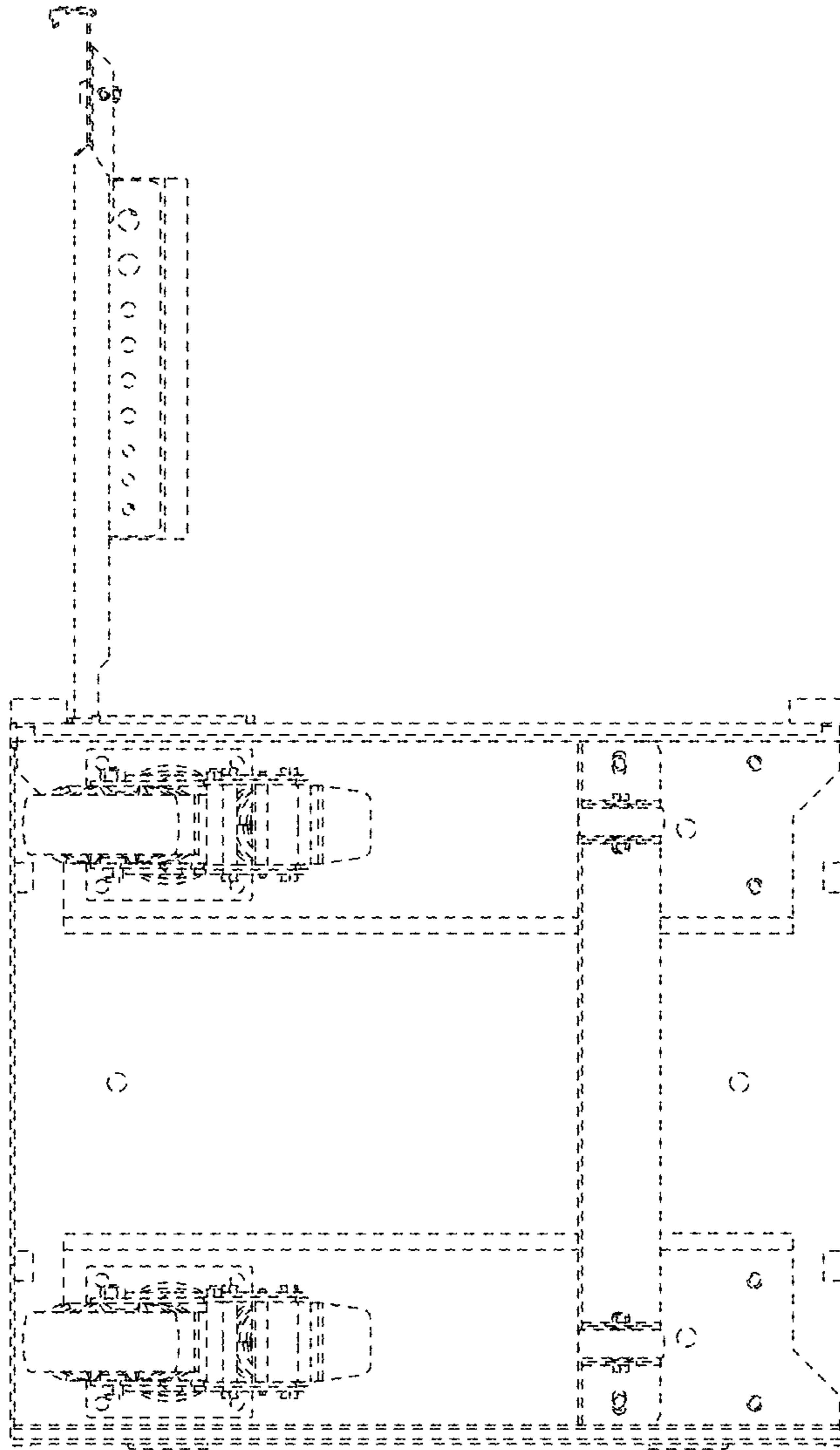

FIG. 7

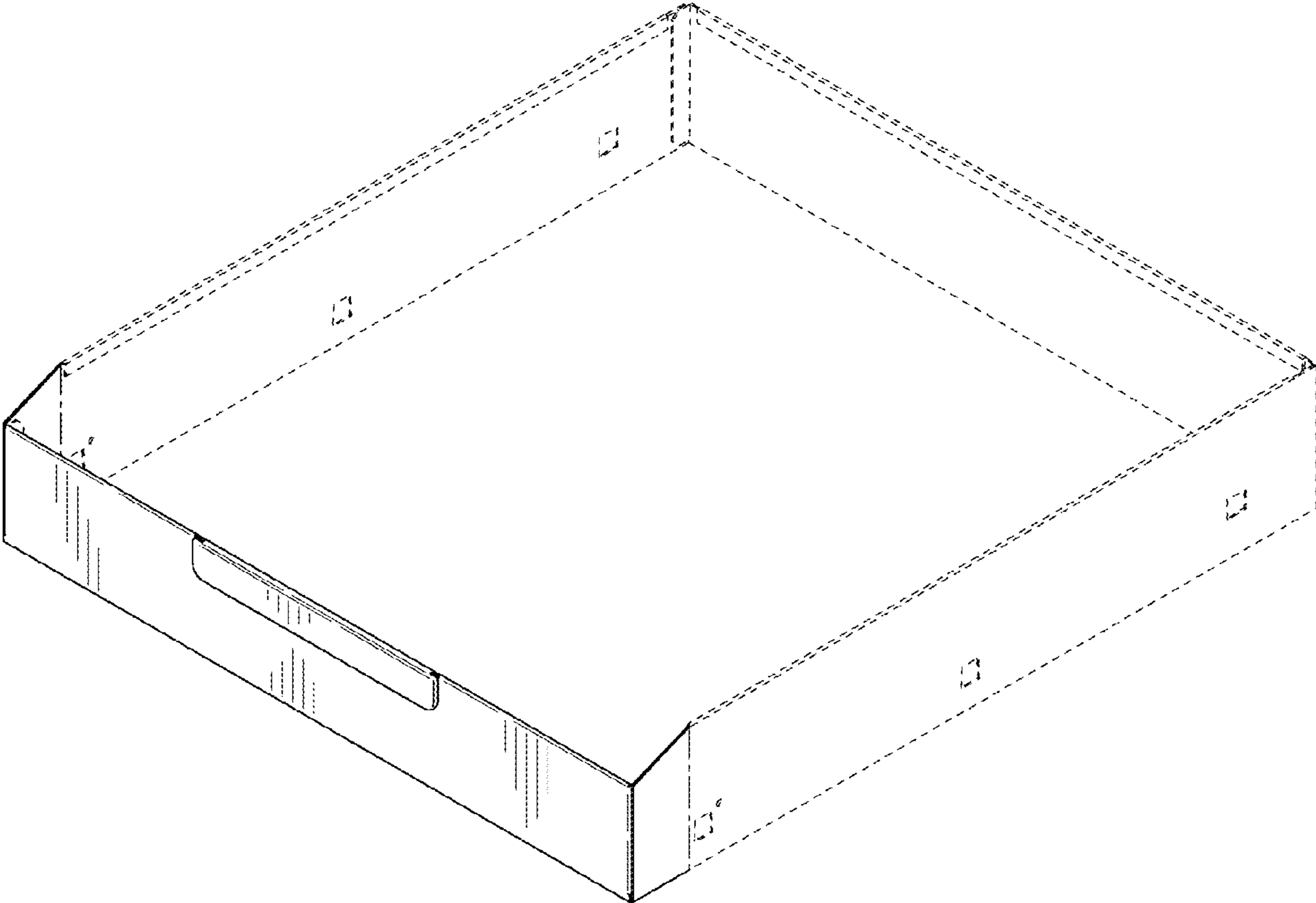

FIG. 8

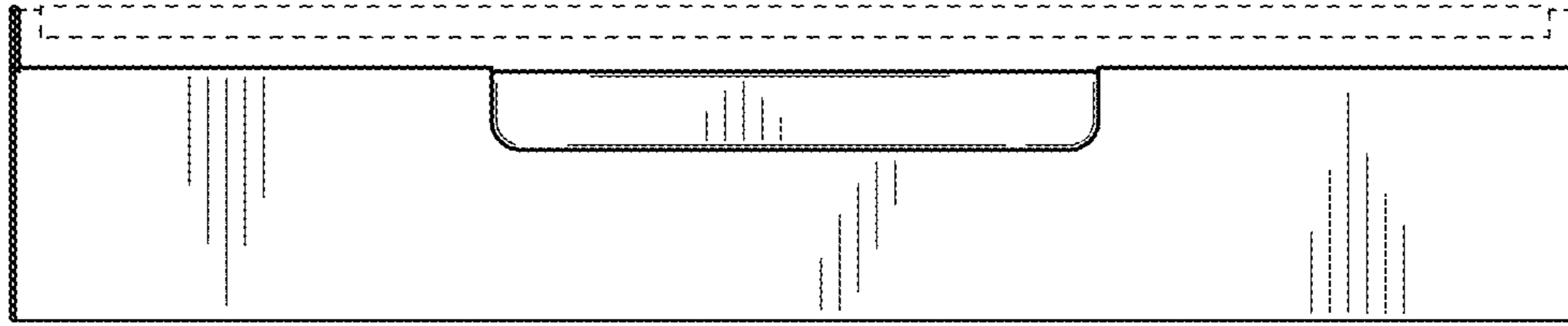

FIG. 9



FIG. 10

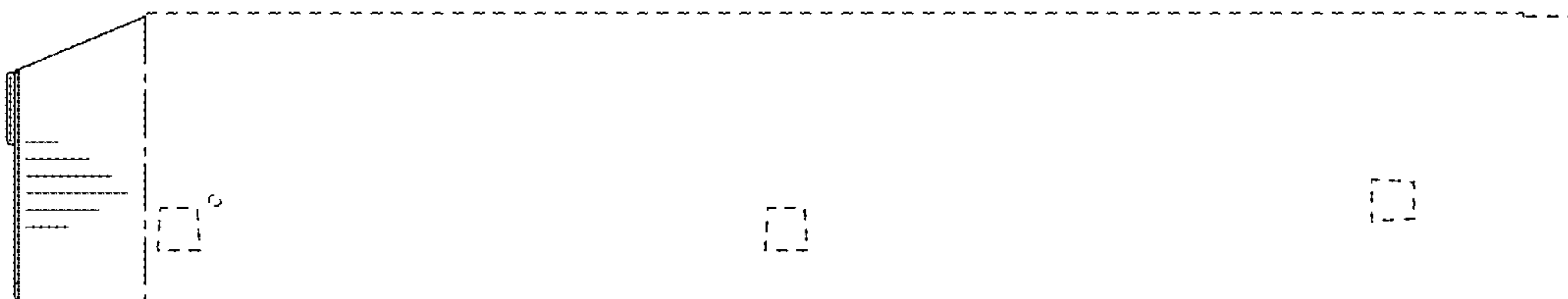

FIG. 11

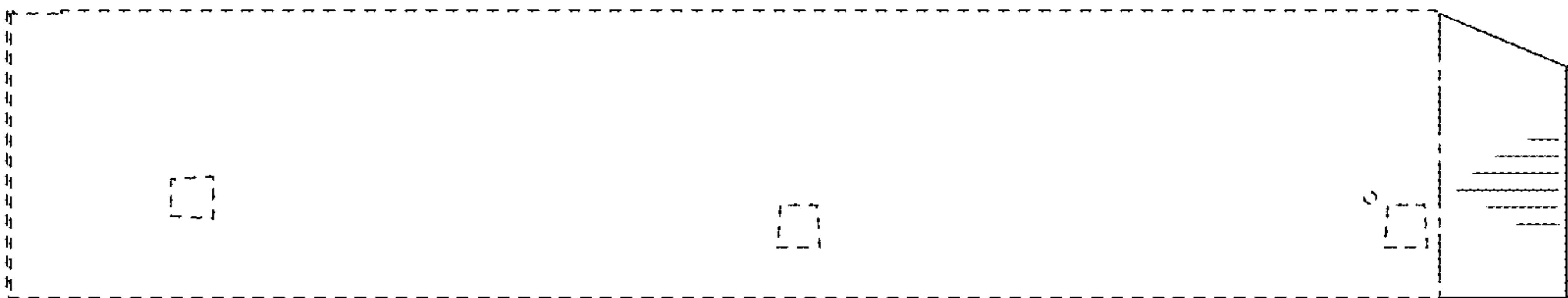

FIG. 12

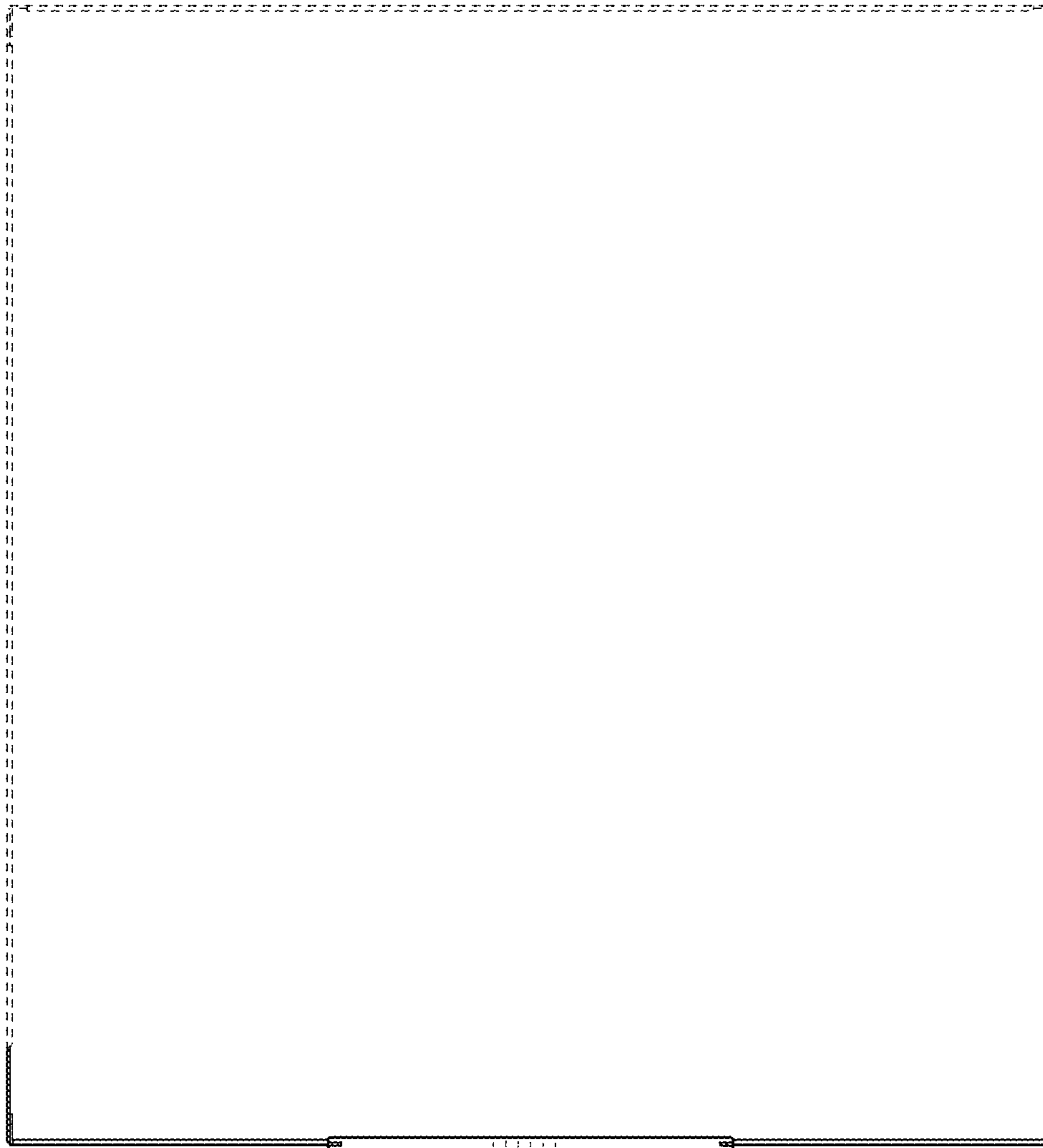

FIG. 13

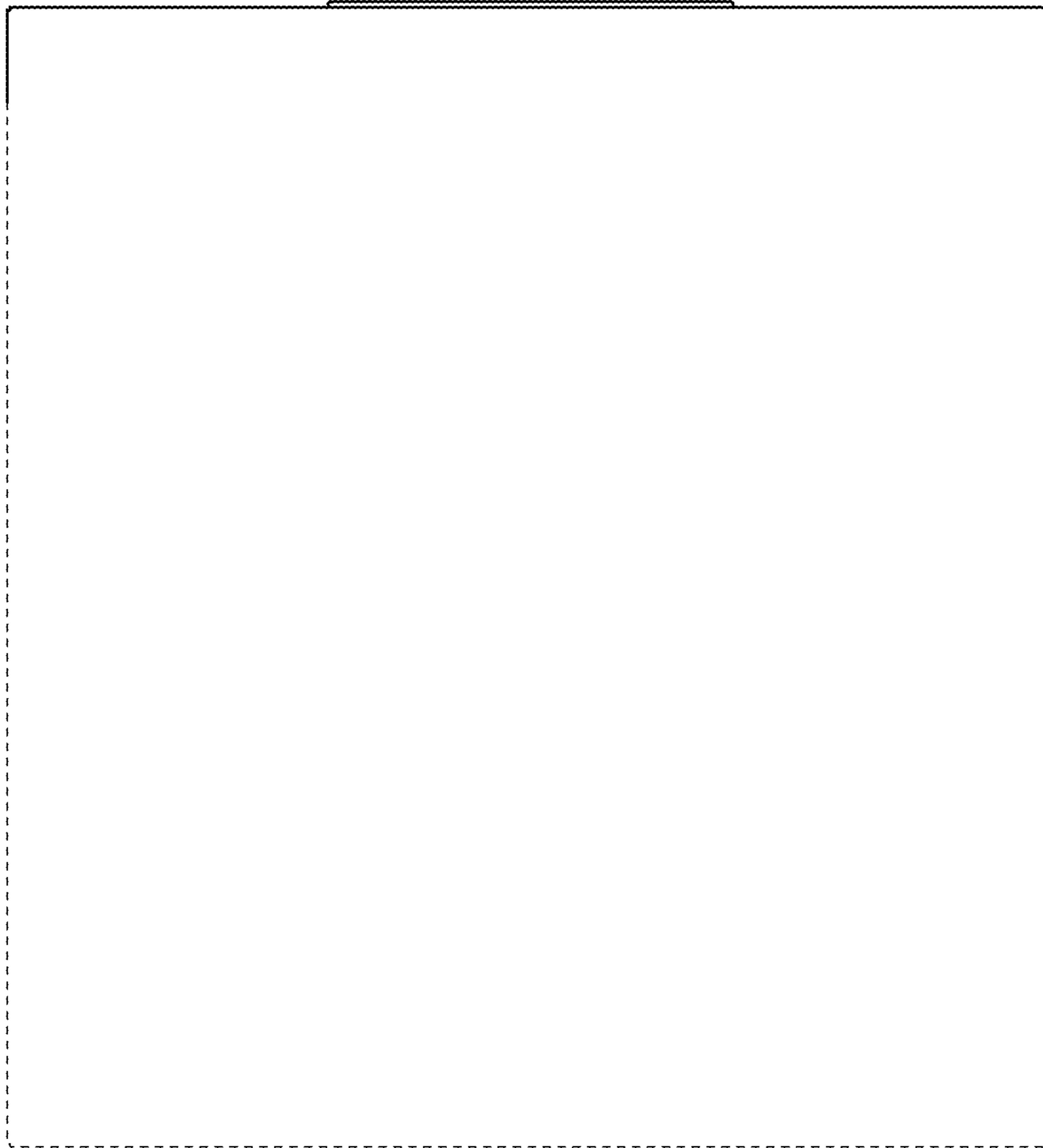

FIG. 14