



US00D915086S

(12) **United States Design Patent** (10) **Patent No.:** **US D915,086 S**
Kanhasamy (45) **Date of Patent:** **** *Apr. 6, 2021**

(54) **CONVERTIBLE ROLL ARM SOFA WITH FOLDABLE TRAY**

(71) Applicant: **Abedan Kanhasamy**, Mississauga (CA)

(72) Inventor: **Abedan Kanhasamy**, Mississauga (CA)

(*) Notice: This patent is subject to a terminal disclaimer.

(**) Term: **15 Years**

(21) Appl. No.: **29/659,332**

(22) Filed: **Aug. 8, 2018**

(30) **Foreign Application Priority Data**

May 18, 2018 (CA) CA 181470

(51) **LOC (13) Cl.** **06-01**

(52) **U.S. Cl.**
USPC **D6/336; D6/381**

(58) **Field of Classification Search**
USPC D6/334, 335, 374, 375, 377, 381, 336, D6/384
CPC A47C 17/00; A47C 17/02; A47C 17/04; A47C 17/045; A47C 17/13; A47C 17/132; A47C 17/134; A47C 17/16; A47C 17/162; A47C 17/17; A47C 17/18; A47C 17/20; A47C 17/86

See application file for complete search history.

(56) **References Cited**

U.S. PATENT DOCUMENTS

D151,295 S * 10/1948 Stanley D6/336
2,452,642 A * 11/1948 Ewing A47C 17/12 297/116
2,658,208 A * 11/1953 Stauffer A47C 17/161 5/27

(Continued)

Primary Examiner — Cathron C Brooks
(74) *Attorney, Agent, or Firm* — Harness, Dickey & Pierce, P.L.C.

(57) **CLAIM**

The ornamental design for a convertible roll arm sofa with foldable tray, as shown and described.

DESCRIPTION

FIG. 1 is a front view of a convertible roll arm sofa with foldable tray embodying the design in a first position; FIG. 2 is a perspective view of the convertible roll arm sofa with foldable tray in the first position; FIG. 3 is a perspective view of the convertible roll arm sofa with foldable tray in a second position; FIG. 4 is a perspective view of the convertible roll arm sofa with foldable tray in a third position; FIG. 5 is a perspective view of the convertible roll arm sofa with foldable tray in a fourth position; FIG. 6 is a perspective view of the convertible roll arm sofa with foldable tray in a fifth position; FIG. 7 is a perspective view of the convertible roll arm sofa with foldable tray in a sixth position; FIG. 8 is a right side view of the convertible roll arm sofa with foldable tray in third position; FIG. 9 is a left side view of the convertible roll arm sofa with foldable tray in third position; FIG. 10 is a right side view of the convertible roll arm sofa with foldable tray in fourth position; FIG. 11 is a left side view of the convertible roll arm sofa with foldable tray in fourth position; FIG. 12 is a perspective view of the convertible roll arm sofa with foldable tray in a seventh position with arrows indicating the direction of movement; and, FIG. 13 is a perspective view of the convertible roll arm sofa with foldable tray in an eighth position with arrows indicating the direction of movement. The broken line showing of the linkage and wheels in the drawings forms no part of the claimed design.

1 Claim, 13 Drawing Sheets

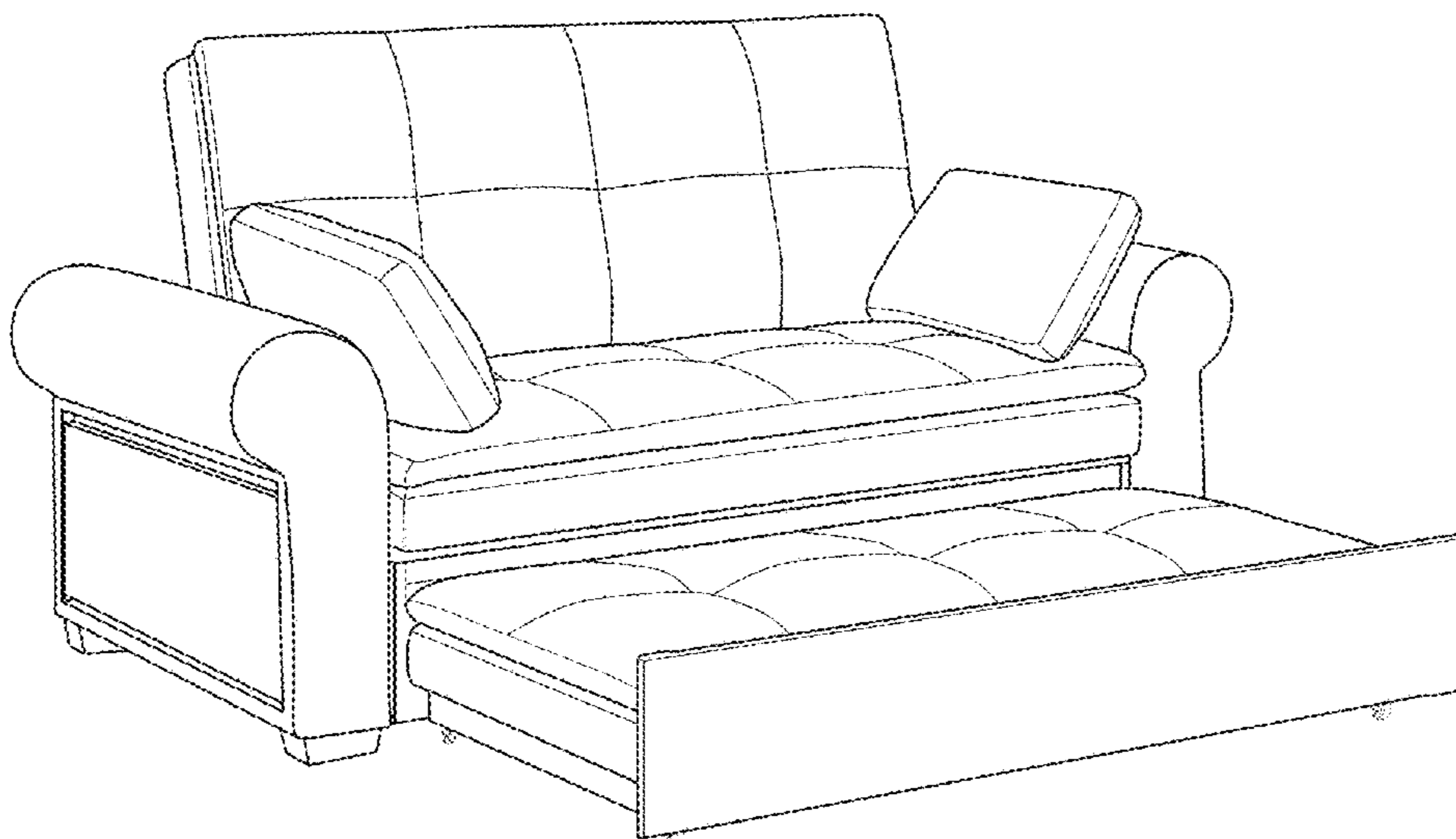

(56)

References Cited

U.S. PATENT DOCUMENTS

D179,829 S * 3/1957 Wilson D6/377
5,217,277 A * 6/1993 Rasnick A47B 43/02
297/145
D477,152 S * 7/2003 Levy D6/335
D618,929 S * 7/2010 Yeong D6/381
D621,174 S * 8/2010 Kanthasamy D6/381
8,434,415 B1 * 5/2013 Federici A47C 7/62
108/38
D719,753 S * 12/2014 Pathiratne D6/381
D738,130 S * 9/2015 Starck D6/381
10,123,627 B2 * 11/2018 King A47C 7/50
D841,992 S * 3/2019 Kershner D6/335
2011/0012393 A1 * 1/2011 Kanthasamy A47B 83/02
297/173
2013/0191989 A1 * 8/2013 Smith A47C 17/165
5/17
2016/0206109 A1 * 7/2016 Nault A47C 17/16

* cited by examiner

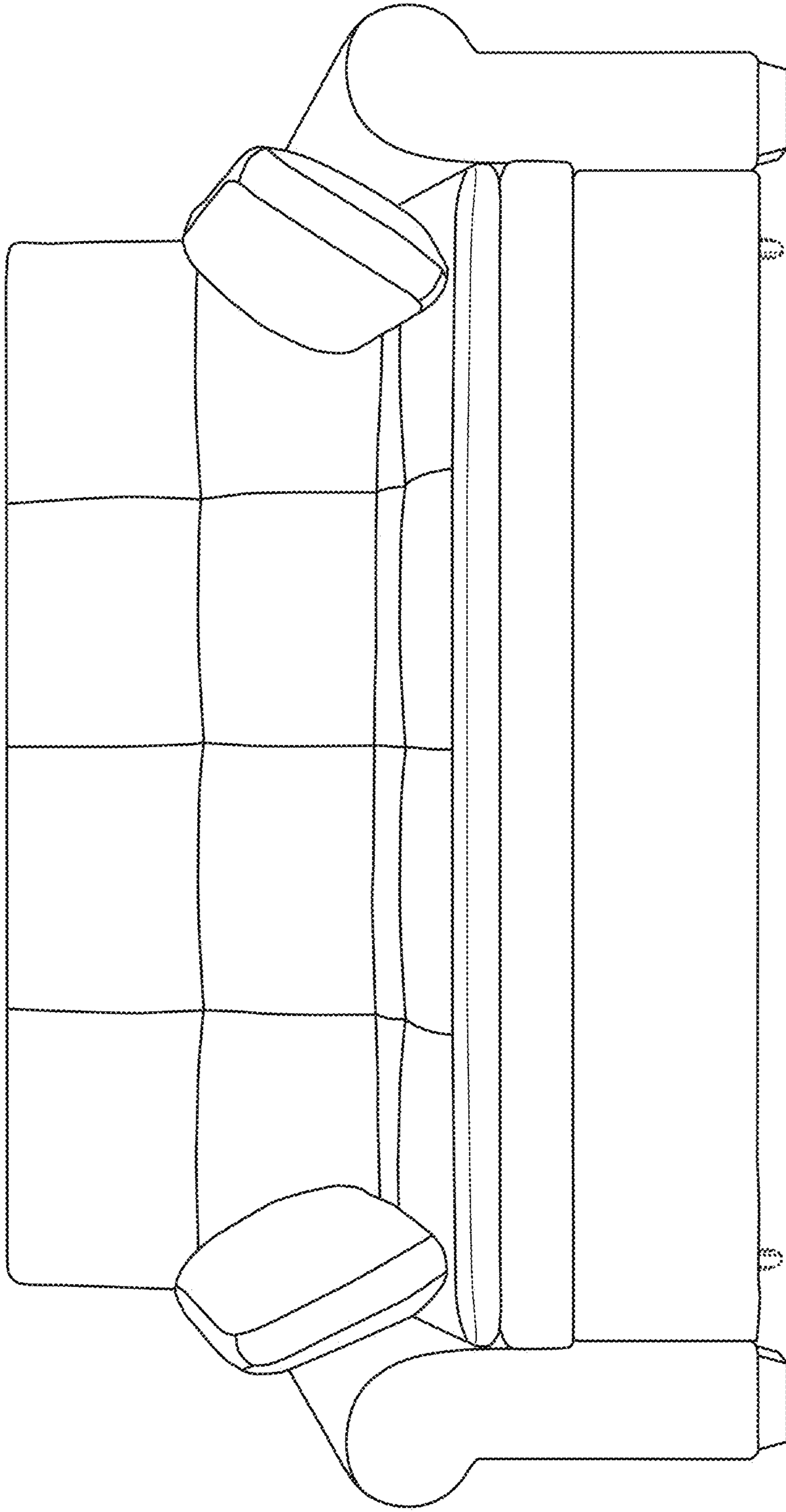

FIG. 1

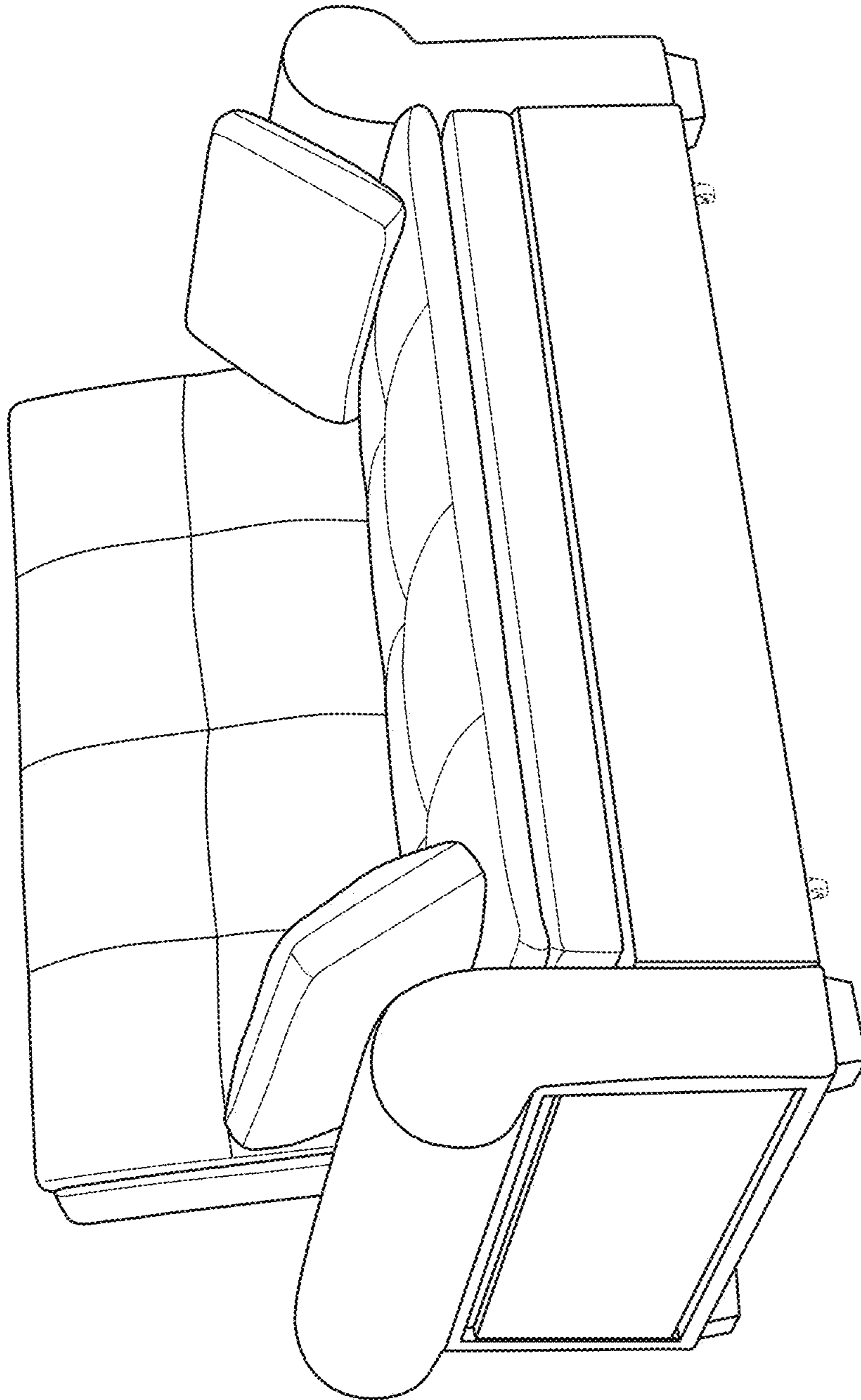

FIG. 2

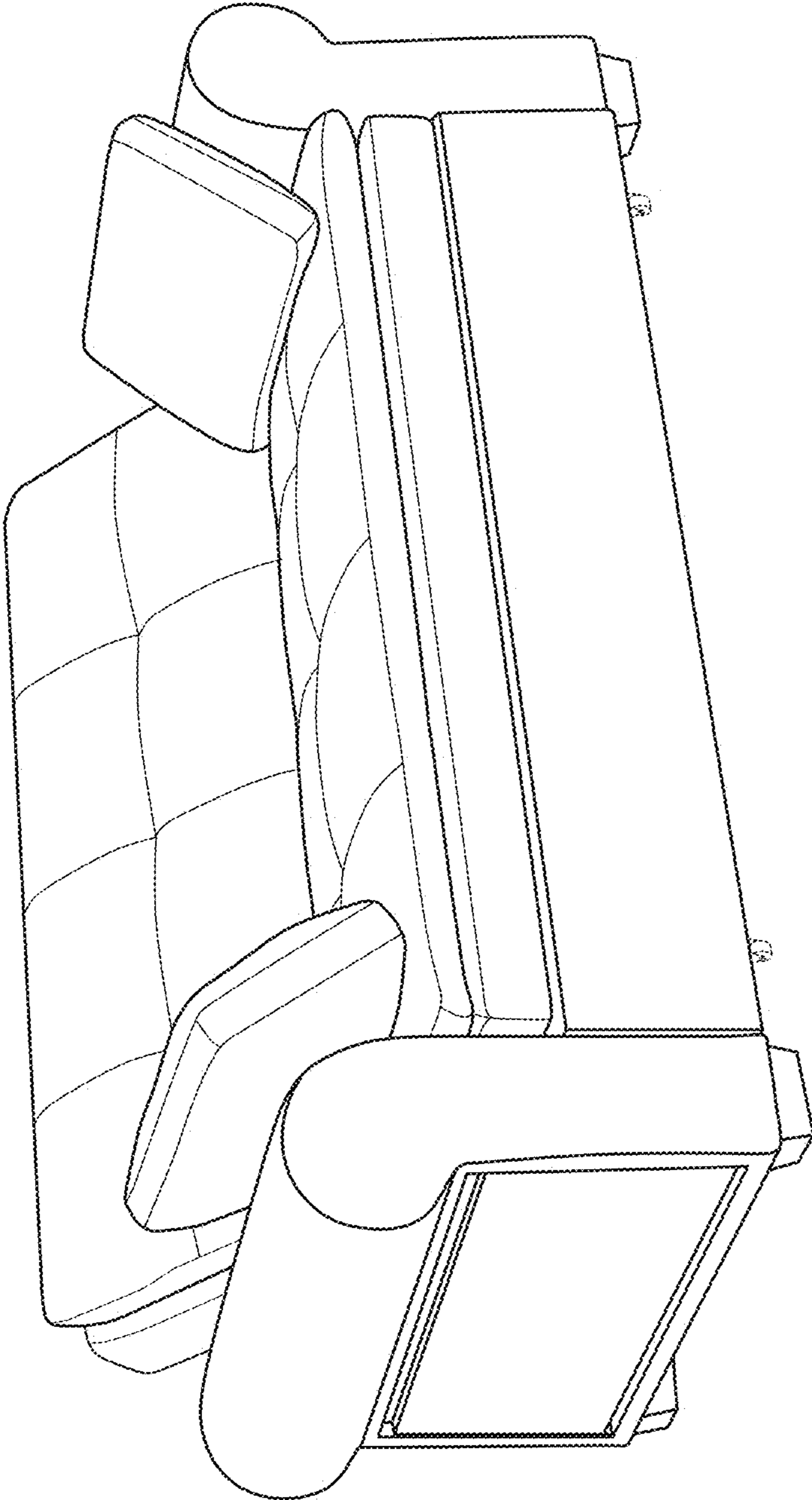

FIG. 3

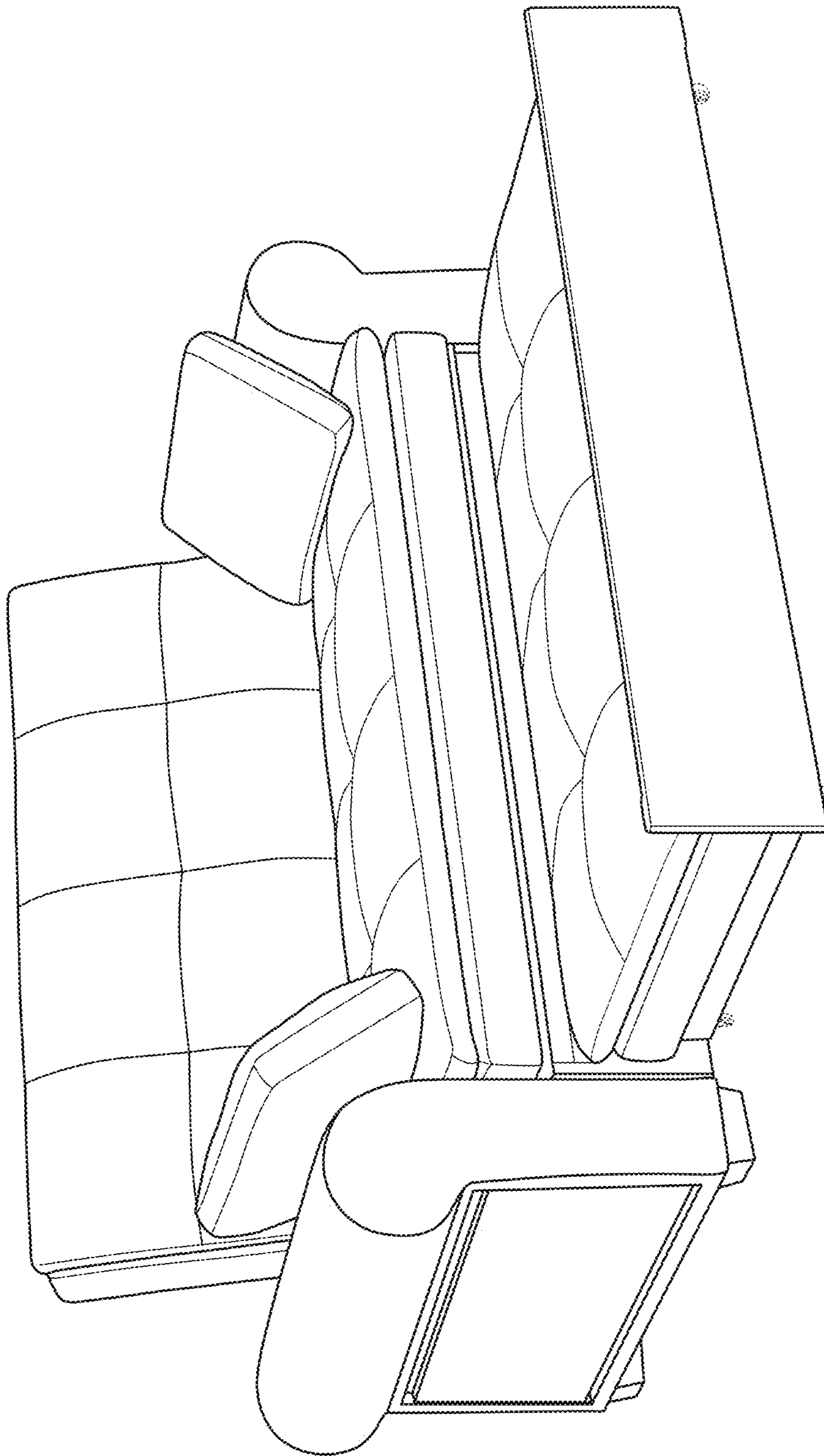

FIG. 4

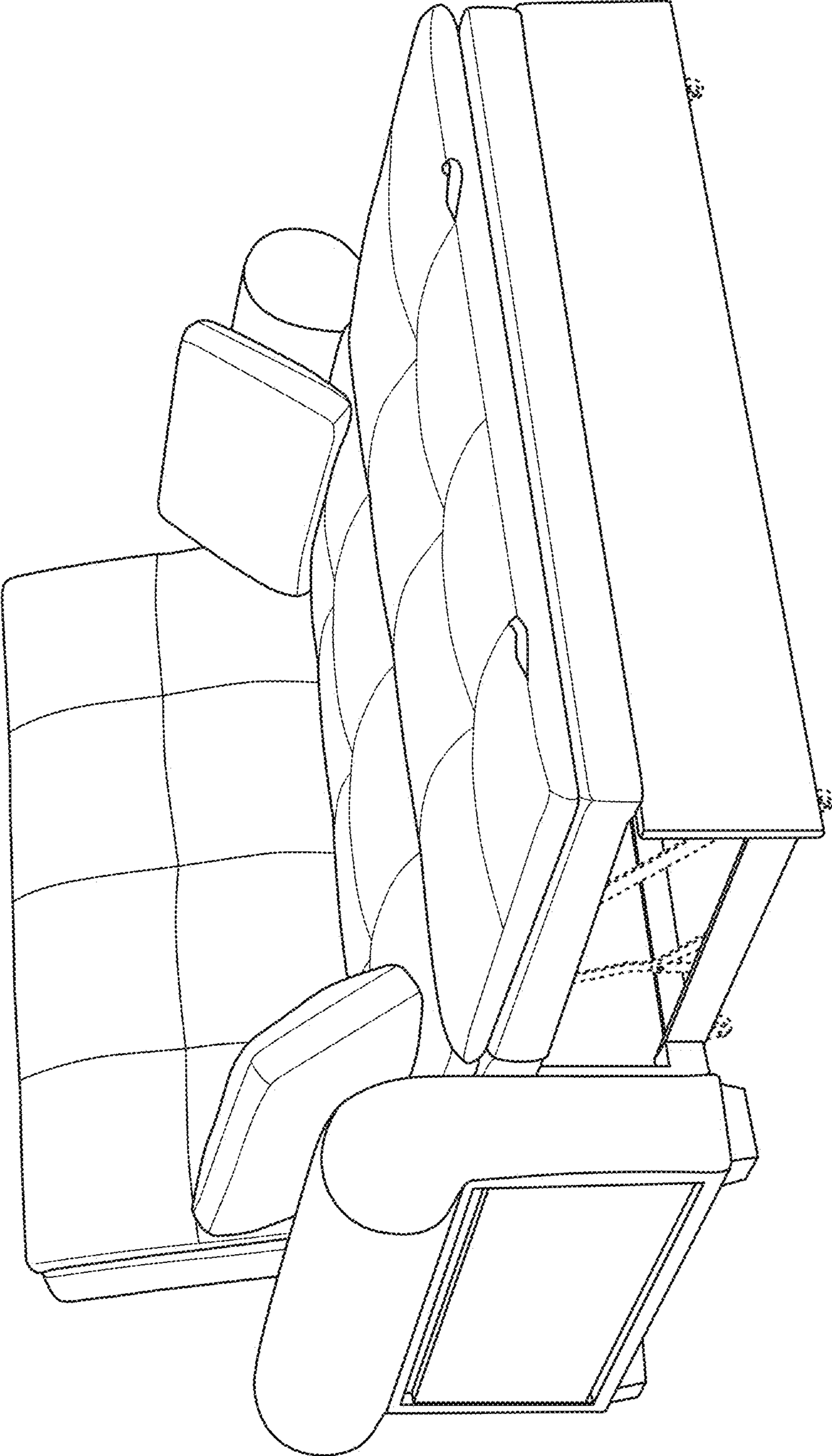

FIG. 5

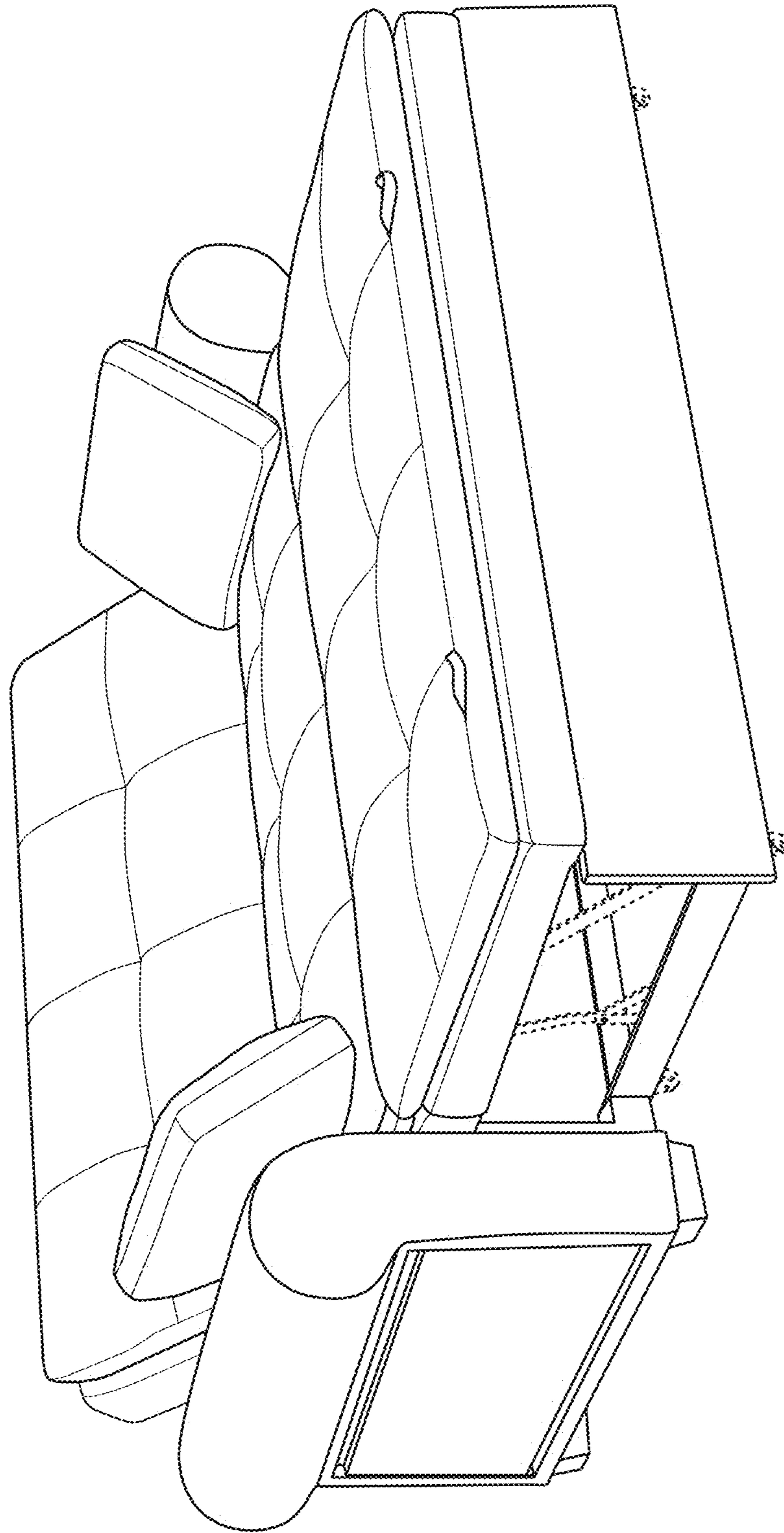

FIG. 6

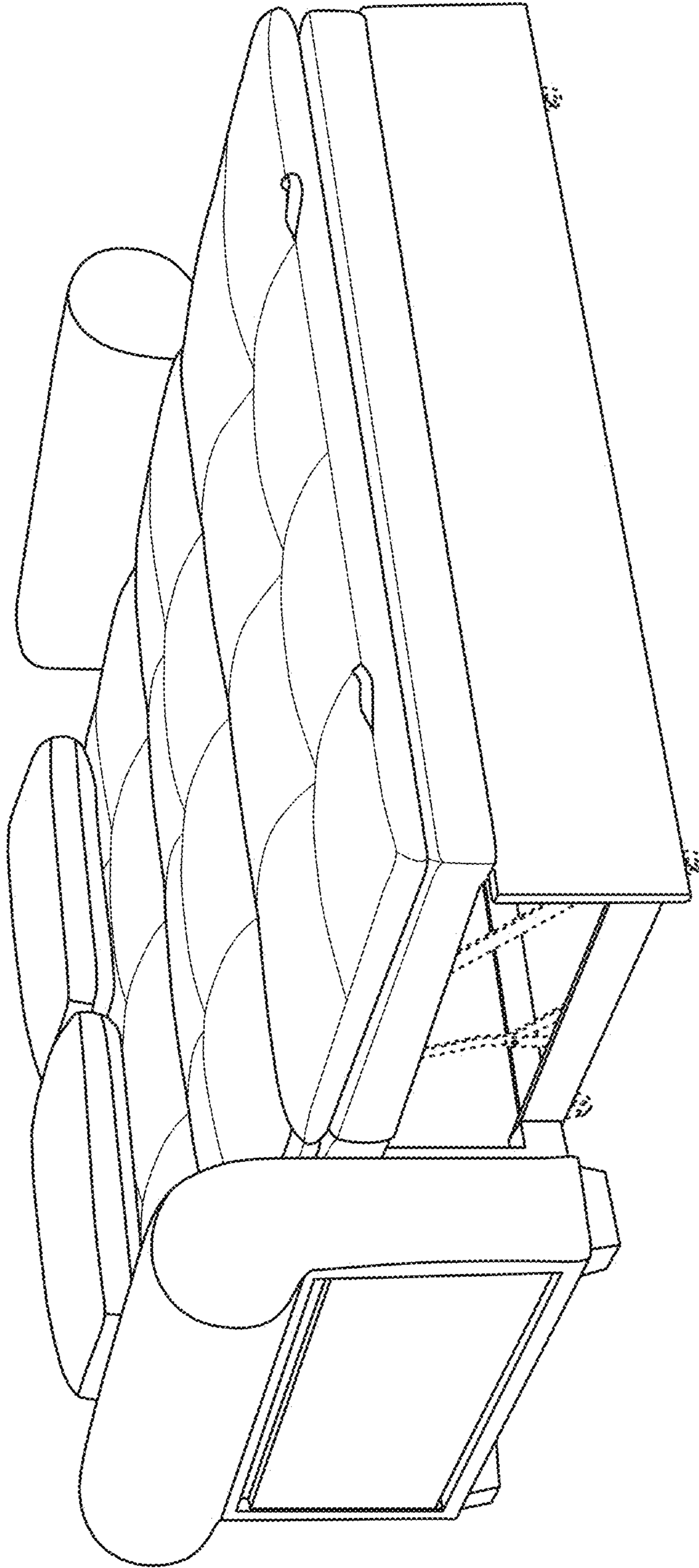

FIG. 7

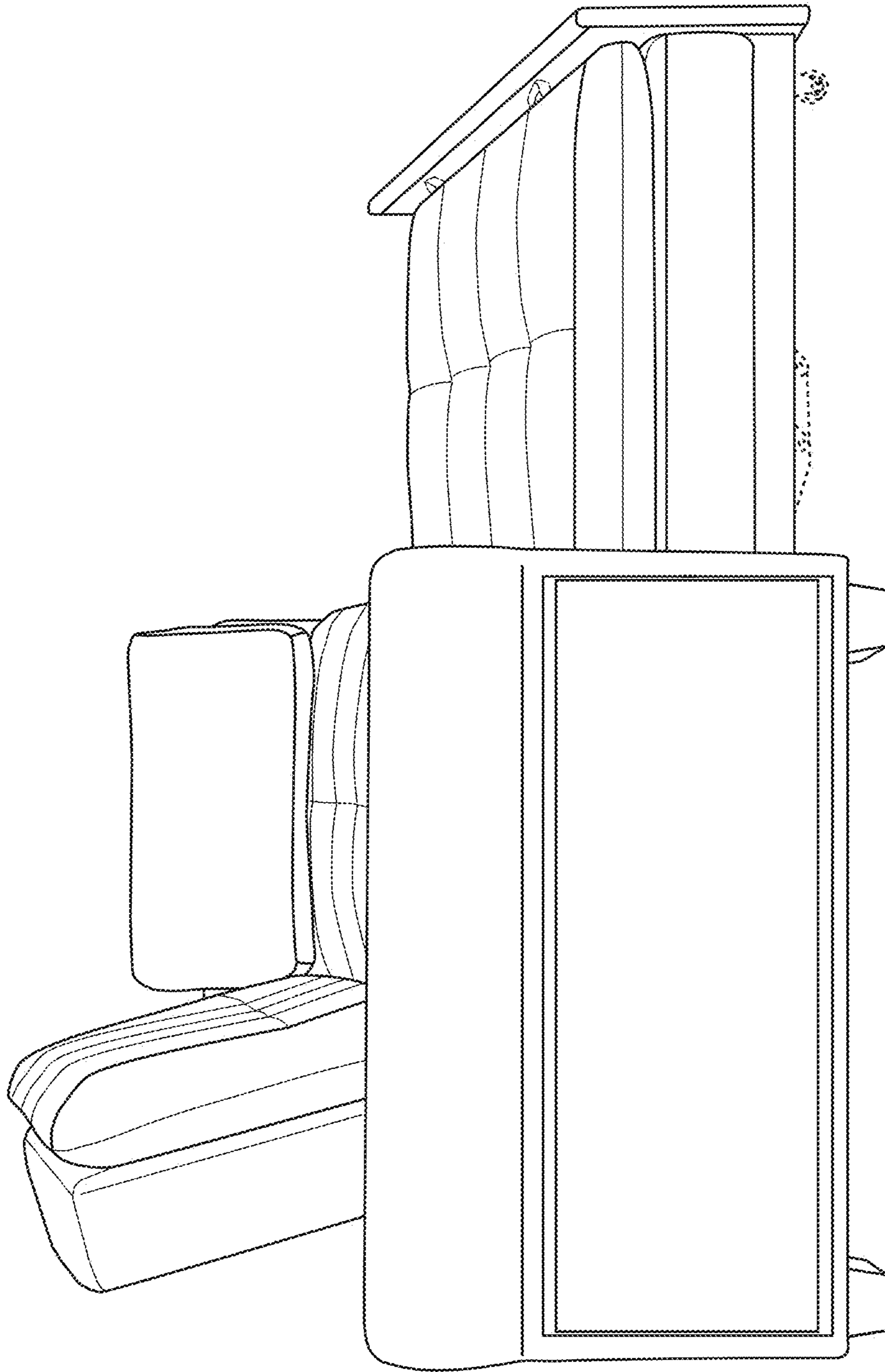

FIG. 8

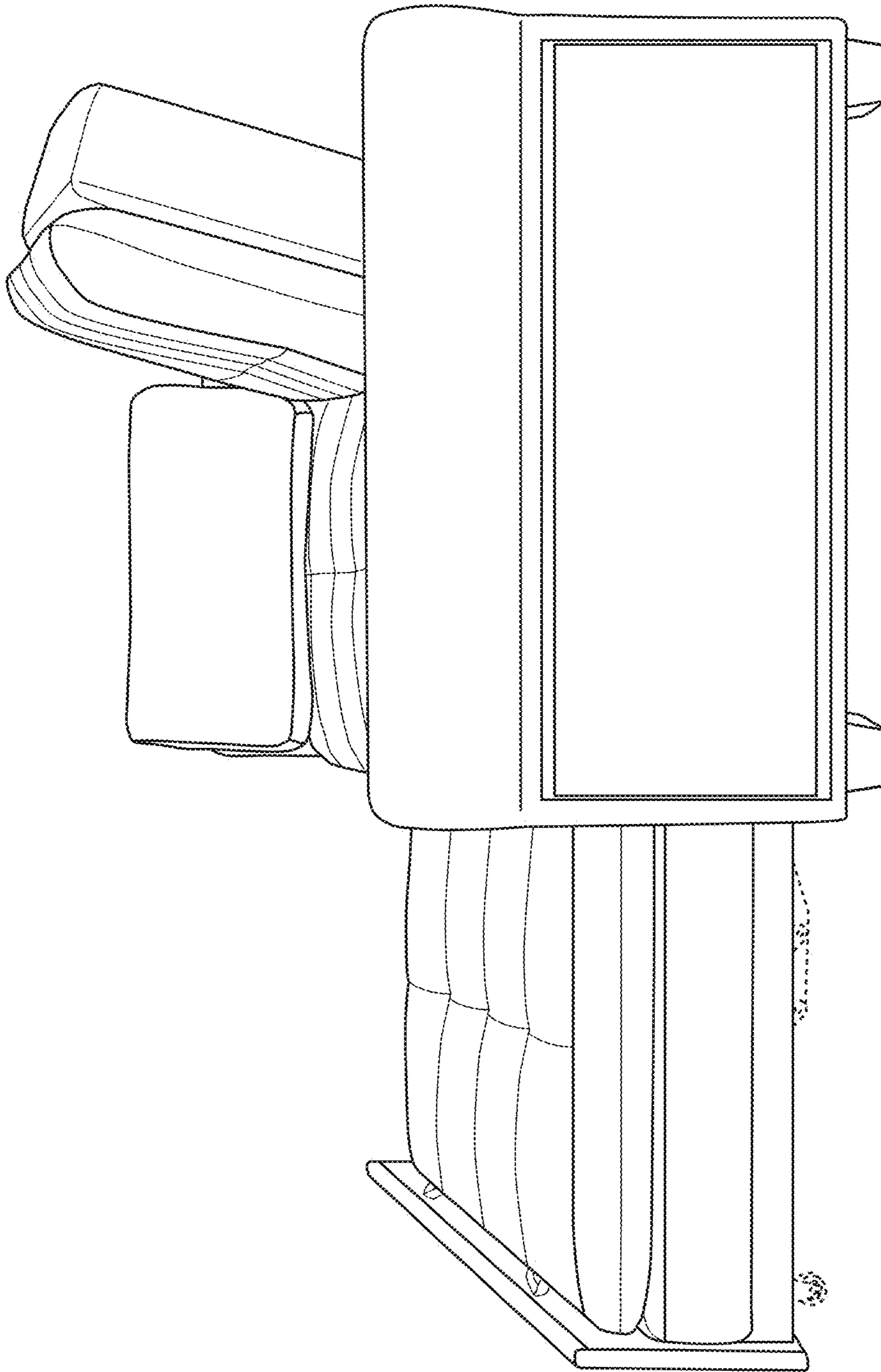

FIG. 9

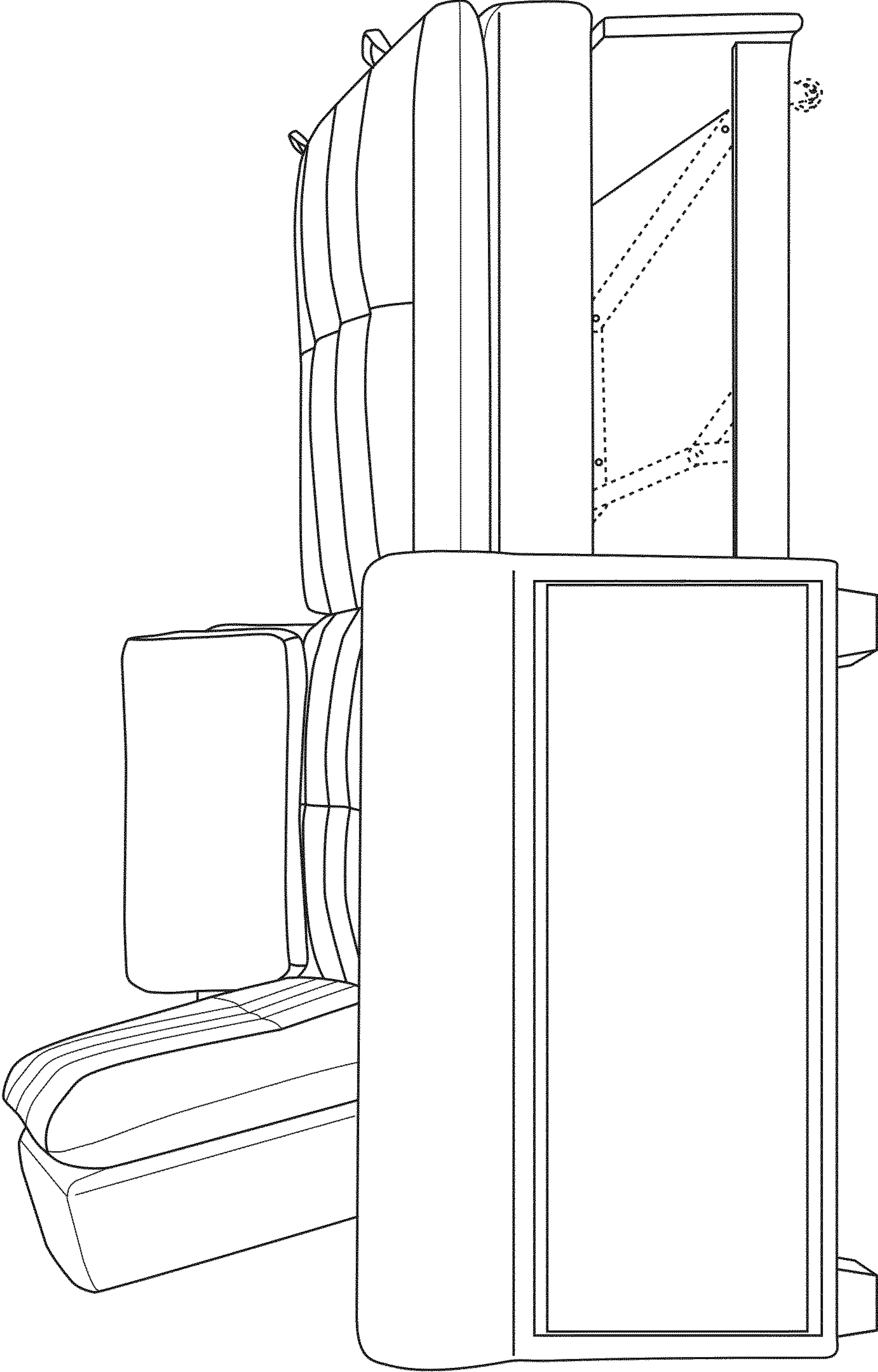

FIG. 10

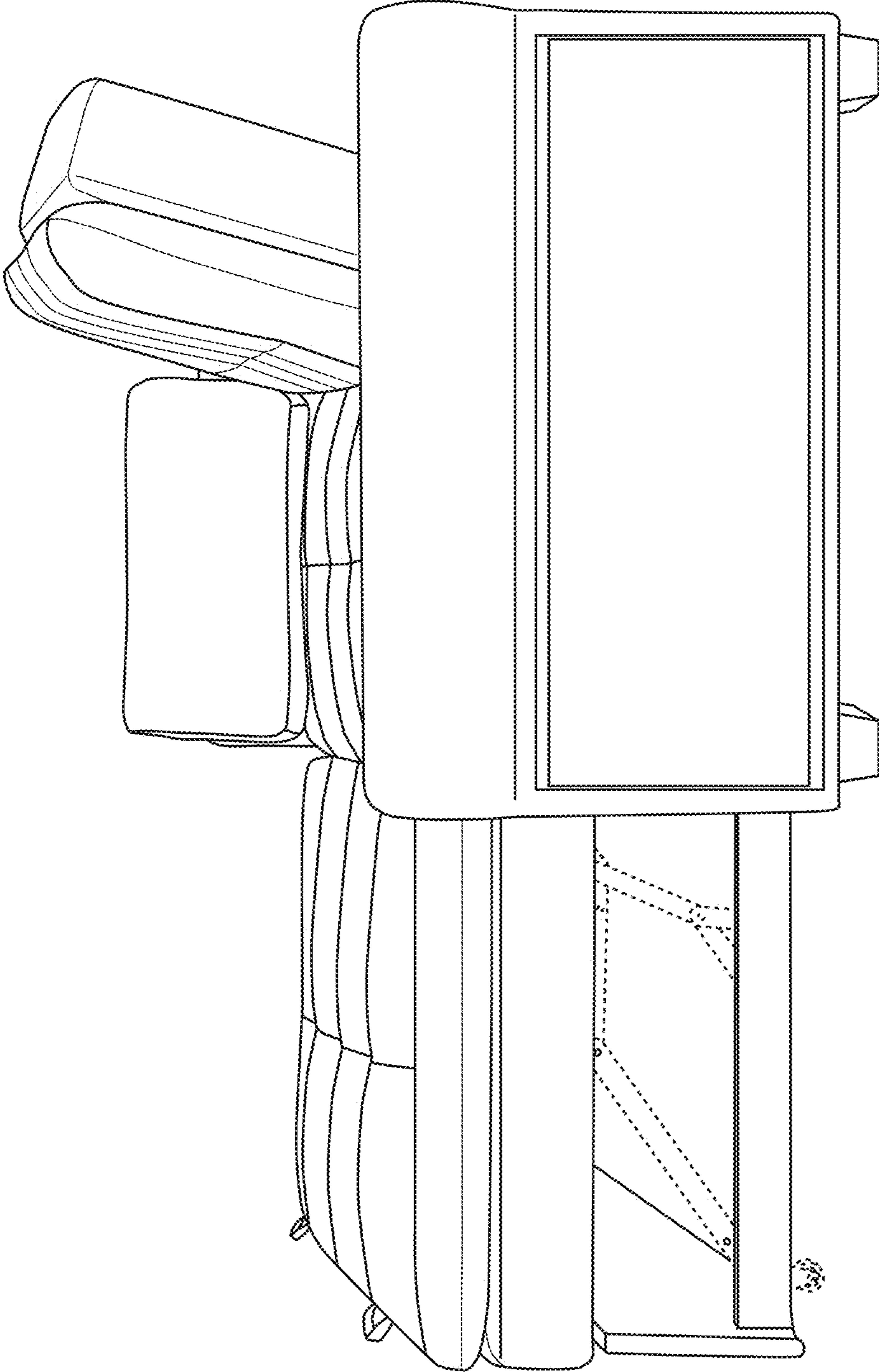

FIG. 11

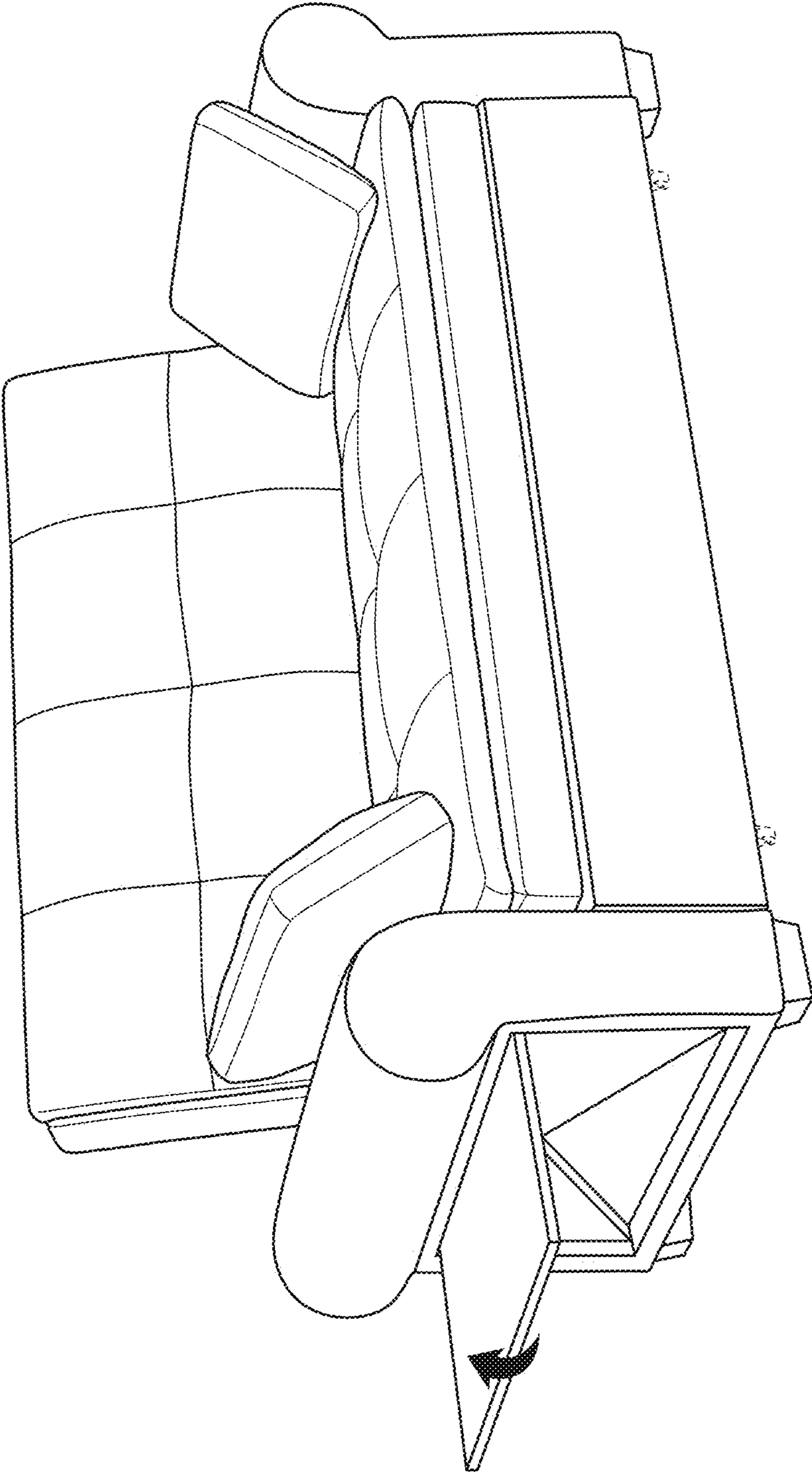

FIG. 12

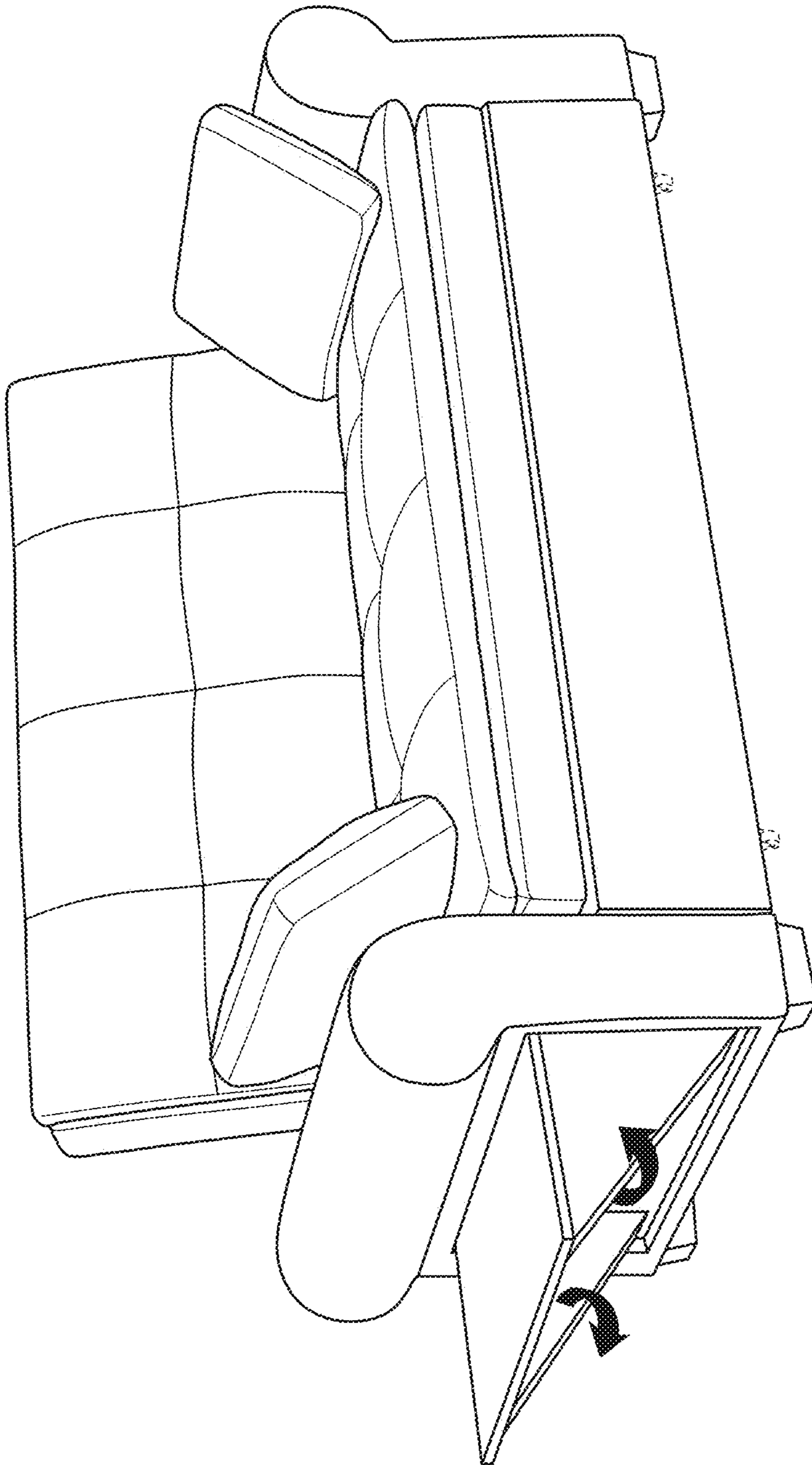

FIG. 13