



US00D914979S

(12) **United States Design Patent** (10) **Patent No.:** **US D914,979 S**
Fleming et al. (45) **Date of Patent:** **** Mar. 30, 2021**

(54) **SHAVER**
(71) Applicant: **WAHL CLIPPER CORPORATION**,
Sterling, IL (US)
(72) Inventors: **Jeff Fleming**, Silvis, IL (US); **Chad Aulwes**, Sterling, IL (US); **Brian Fagan**, Oregon, IL (US); **Aaron Flick**, Sterling, IL (US)
(73) Assignee: **WAHL CLIPPER CORPORATION**,
Sterling, IL (US)

(**) Term: **15 Years**

(21) Appl. No.: **29/720,544**

(22) Filed: **Jan. 14, 2020**

(51) **LOC (13) Cl.** **28-03**

(52) **U.S. Cl.**
USPC **D28/51**

(58) **Field of Classification Search**
USPC D28/49-54
CPC B26B 19/00-08; B26B 19/10-12; B26B 19/20-24; B26B 19/26-265; B26B 19/38-3826; B26B 19/3873-3893; B26B 19/42

See application file for complete search history.

(56) **References Cited**

U.S. PATENT DOCUMENTS

3,997,968 A * 12/1976 Czerner B26B 19/38
30/43.92
4,118,863 A 10/1978 Sandy
D251,621 S 4/1979 Mestrovic et al.
D255,053 S * 5/1980 Schade D28/49
D276,275 S * 11/1984 Nagelkerke D28/49
D305,160 S * 12/1989 Camens D28/51
4,969,266 A * 11/1990 Poganitsch B26B 19/382
30/34.05
D321,413 S * 11/1991 Elkerbout D28/51
D325,449 S * 4/1992 Elkerbout D28/49

D326,166 S * 5/1992 Yanagida D28/49
5,131,148 A 6/1992 Wahl
5,193,275 A * 3/1993 Hirokazu B26B 19/04
30/43
D341,907 S * 11/1993 Ullmann D28/49
(Continued)

OTHER PUBLICATIONS

Wahl Professional 5Star Shaver, 1 page, www.amazon.com, reviewed as early as https://www.amazon.com/Wahl-Professional-5-Star-Rechargeable-8061-100/dp/B01EG4G7BQ (Year: 2018).*

Primary Examiner — Jennifer Rivard
(74) *Attorney, Agent, or Firm* — Greer, Burns & Crain, Ltd.

(57) **CLAIM**

The ornamental design for a shaver, as shown and described.

DESCRIPTION

FIG. 1 is a top perspective view of a first embodiment of the present shaver;
FIG. 2 is a left side view of same;
FIG. 3 is a right side view of the shaver of FIG. 1;
FIG. 4 is a front view of same;
FIG. 5 is a rear view of the shaver of FIG. 1;
FIG. 6 is a top view of same; and
FIG. 7 is a bottom view of the shaver of FIG. 1;
FIG. 8 is a top perspective view of a second embodiment of the present shaver;
FIG. 9 is a left side view of same;
FIG. 10 is a right side view of the shaver of FIG. 8;
FIG. 11 is a front view of same;
FIG. 12 is a rear view of the shaver of FIG. 8;
FIG. 13 is a top view of same; and
FIG. 14 is a bottom view of the shaver of FIG. 8.
The broken lines illustrate portions of the shaver and form no part of the claimed design.

1 Claim, 10 Drawing Sheets

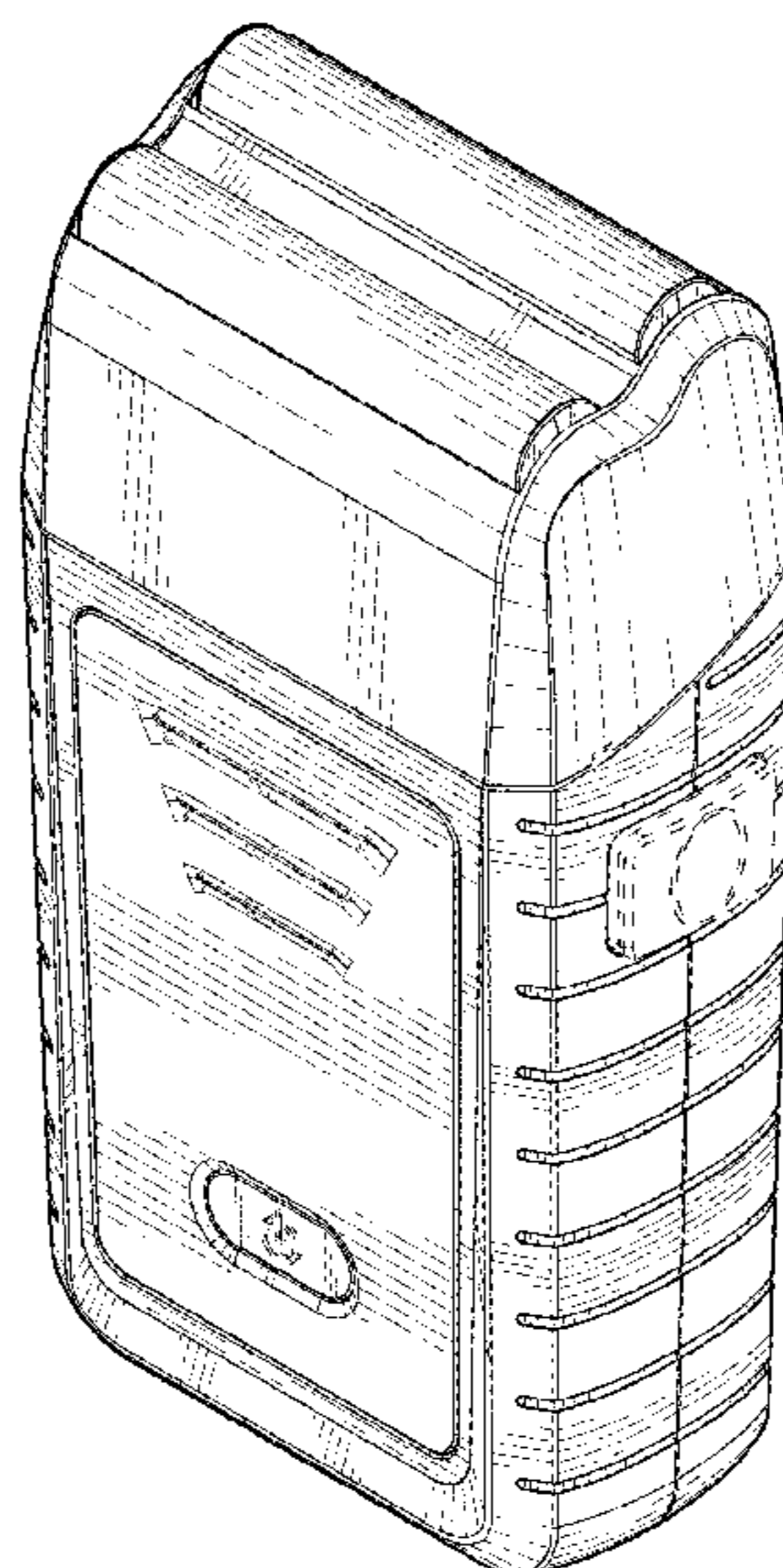

(56)

References Cited

U.S. PATENT DOCUMENTS

D351,926	S *	10/1994	Nakashima	D28/49
D367,945	S *	3/1996	Ullmann	D28/51
D379,012	S *	4/1997	van Asten	D28/51
D391,022	S *	2/1998	Ullman	D28/49
D392,772	S *	3/1998	Ullmann	D28/49
D400,302	S *	10/1998	Ullmann	D28/49
D437,974	S *	2/2001	Yip	D28/51
6,782,625	B1 *	8/2004	Wong	B26B 19/382 30/34.05
D541,988	S	5/2007	Li et al.	
7,503,118	B2 *	3/2009	Oh	B26B 19/048 30/43.1
D654,223	S	2/2012	Aulwes et al.	
D663,897	S	7/2012	Aulwes et al.	
D676,198	S *	2/2013	Lin	D28/49
8,677,627	B2	3/2014	Li et al.	
D722,198	S *	2/2015	Wong	D28/49
D749,268	S *	2/2016	Wan	D28/51
D818,646	S *	5/2018	Szymanski	D28/51
D868,376	S *	11/2019	Sterzi	D28/53
D893,102	S *	8/2020	Jiang	D28/49
2006/0283019	A1 *	12/2006	Oh	B26B 19/3853 30/47
2011/0099816	A1 *	5/2011	Carlucci	B26B 19/06 30/47

* cited by examiner

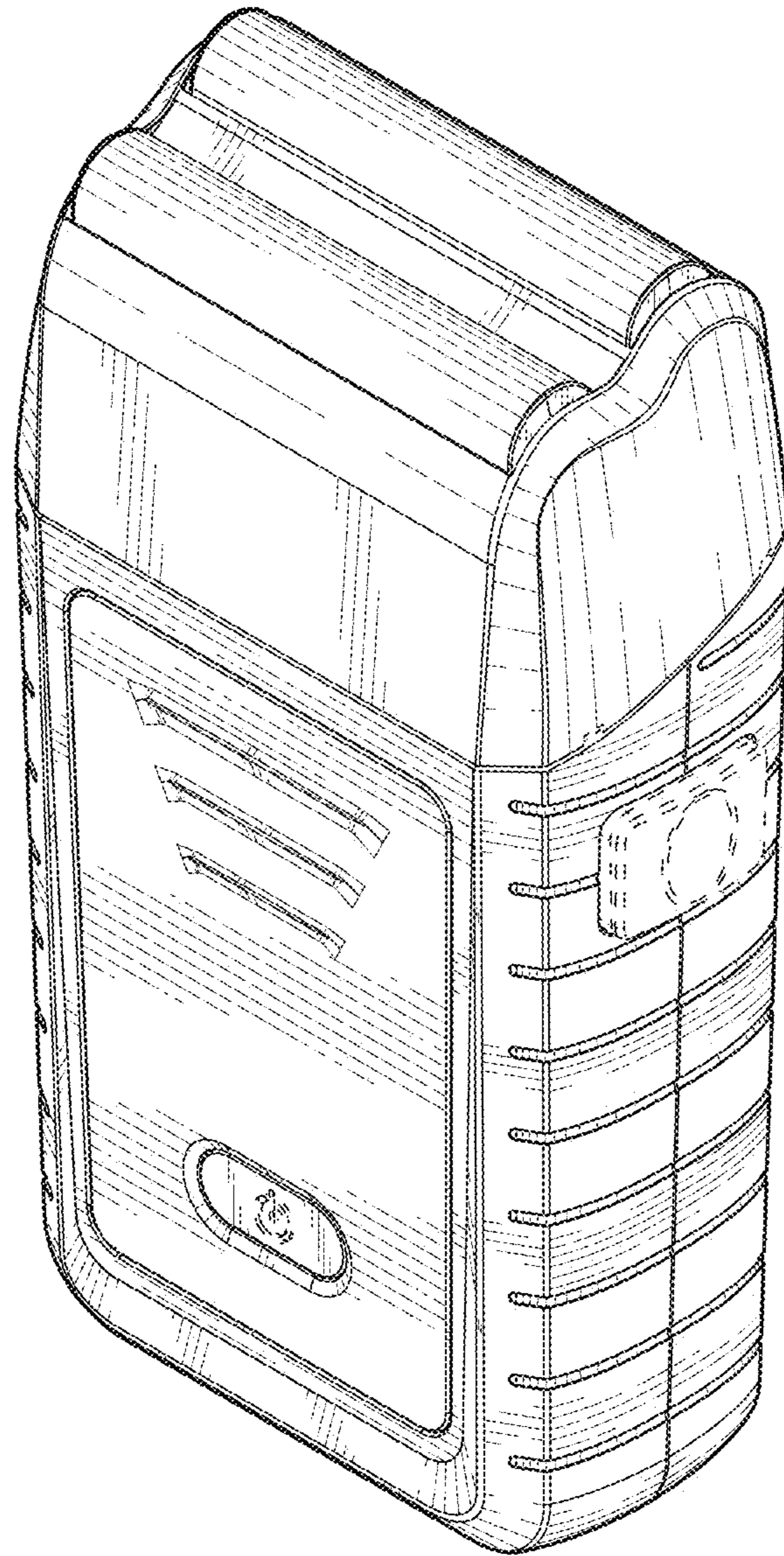

FIG. 1

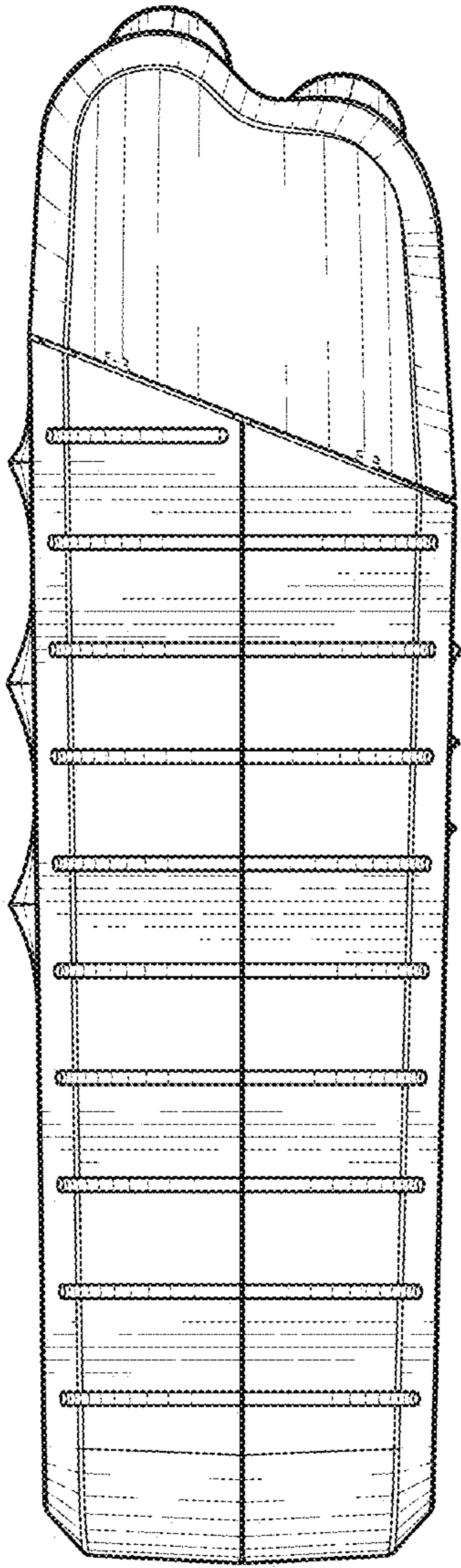

FIG. 2

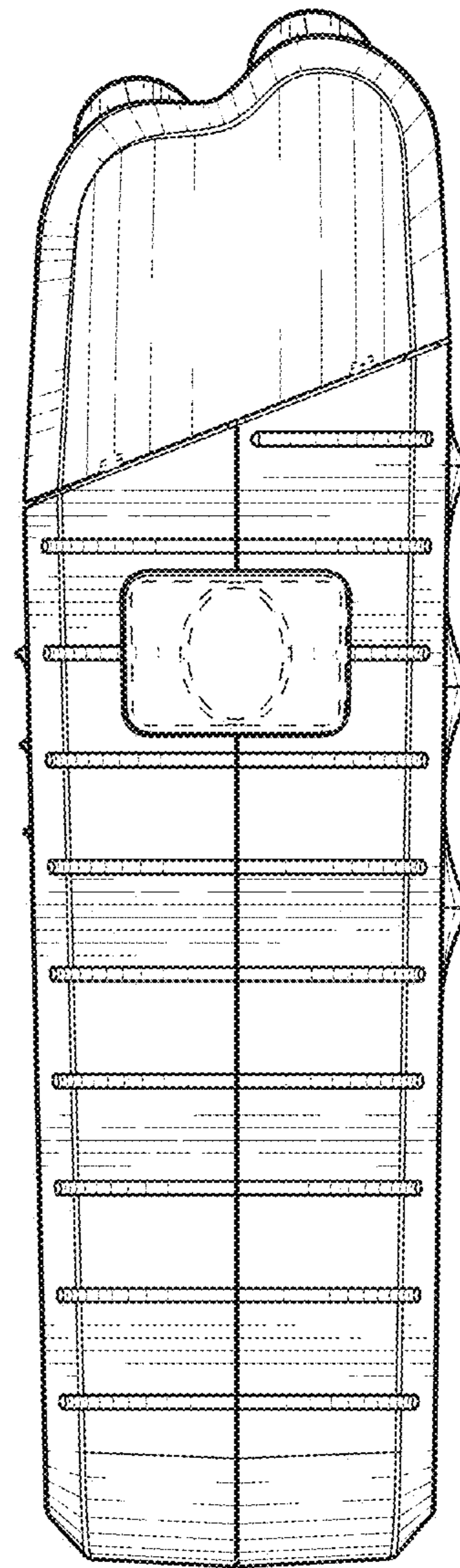

FIG. 3

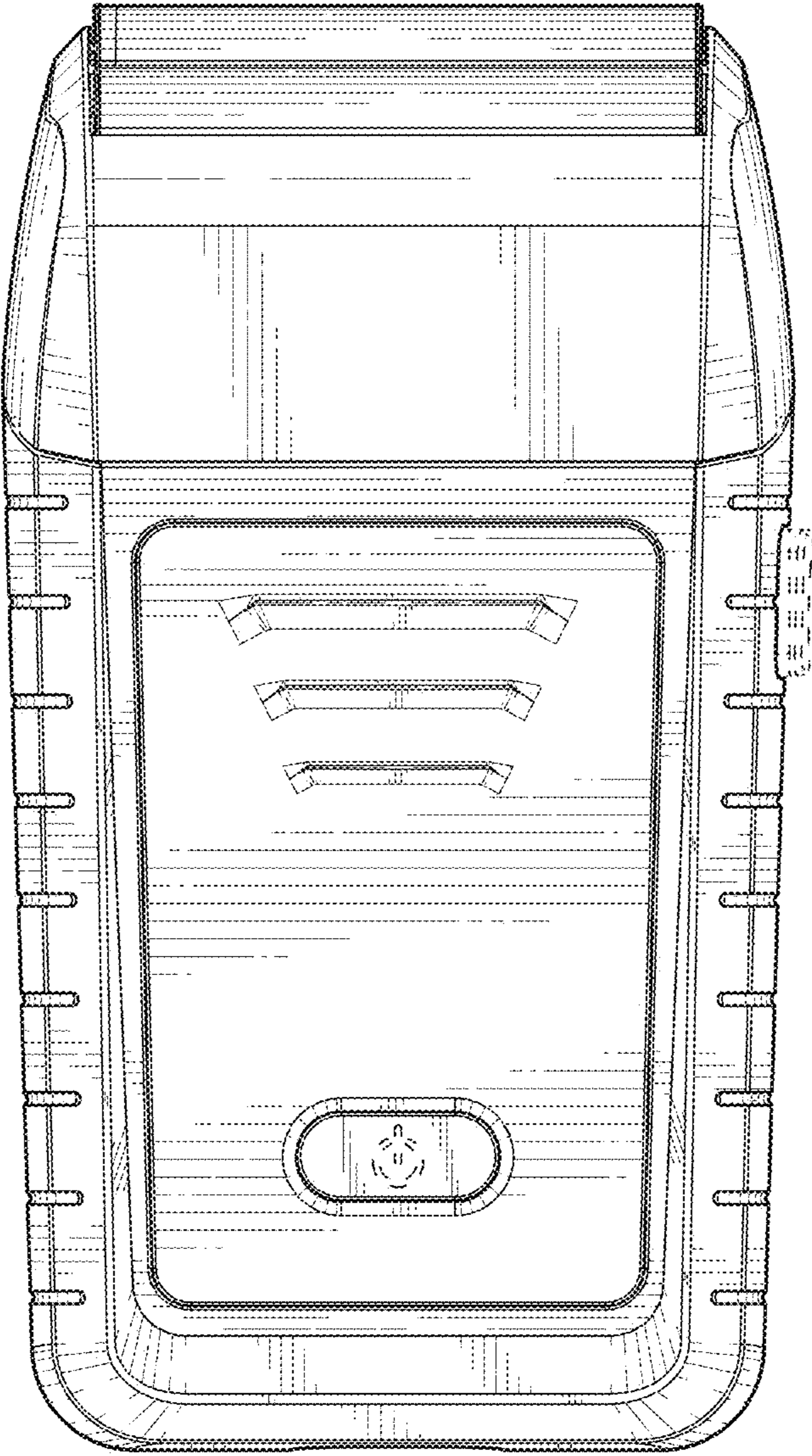

FIG. 4

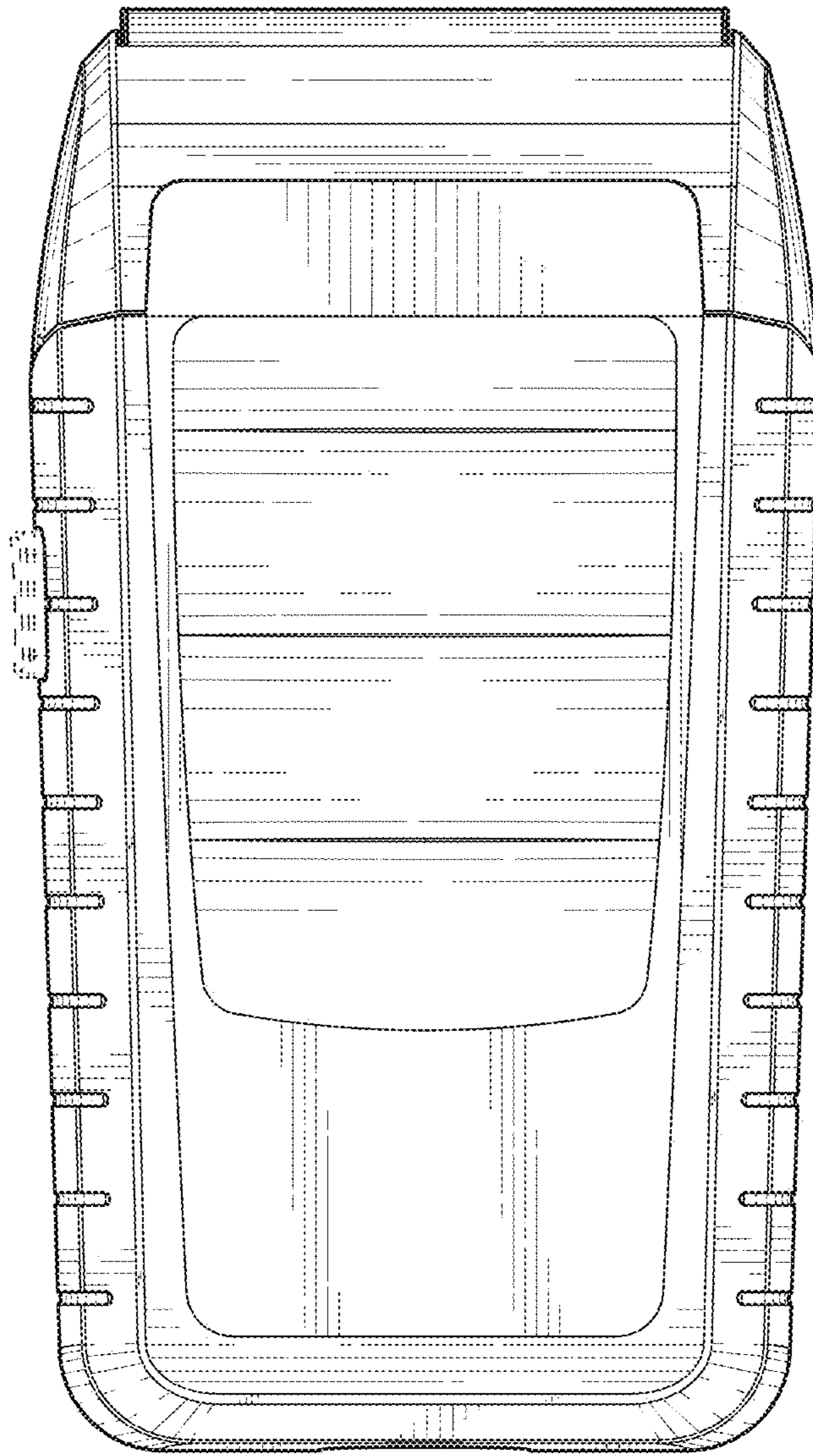

FIG. 5

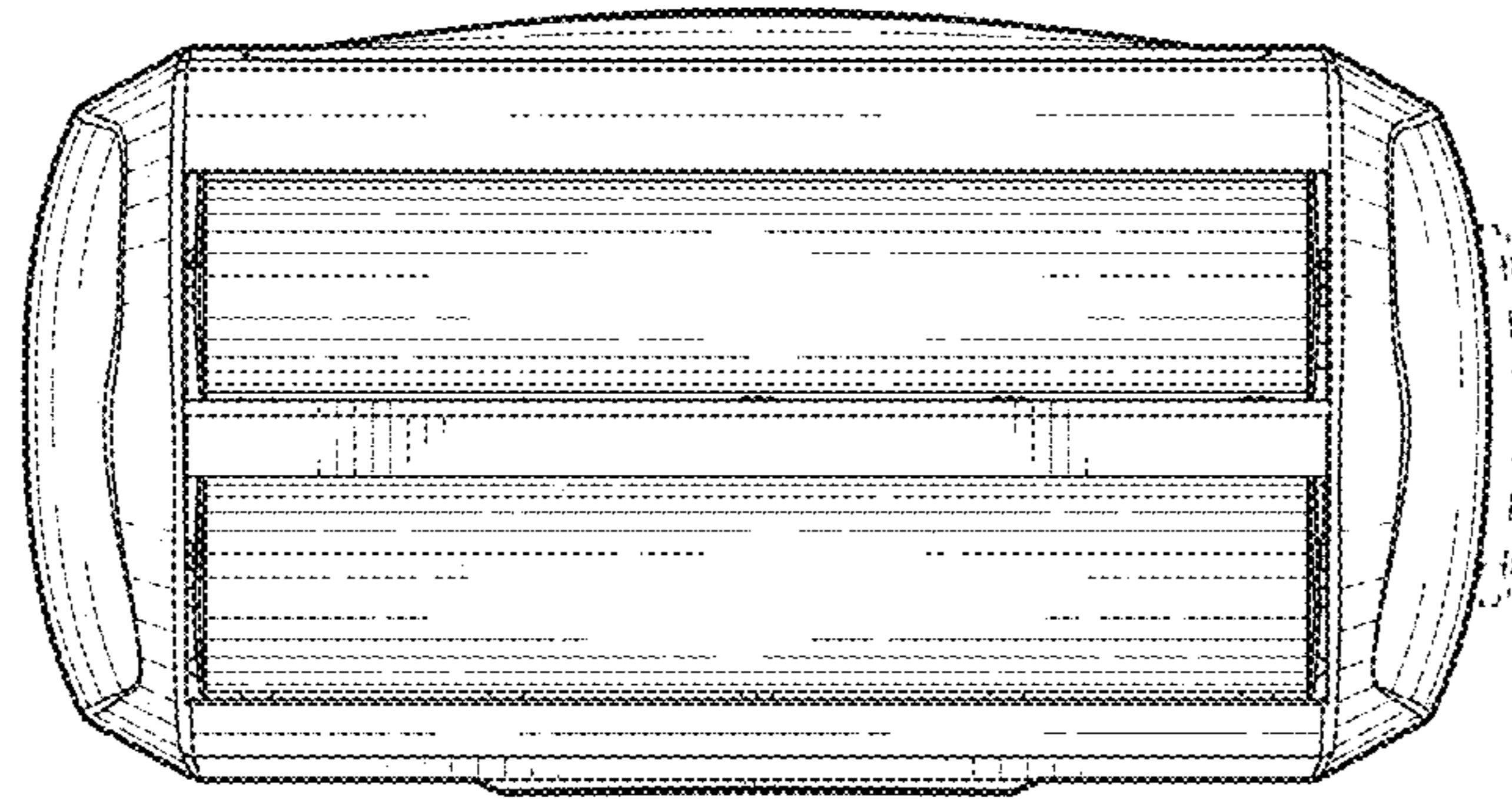

FIG. 6

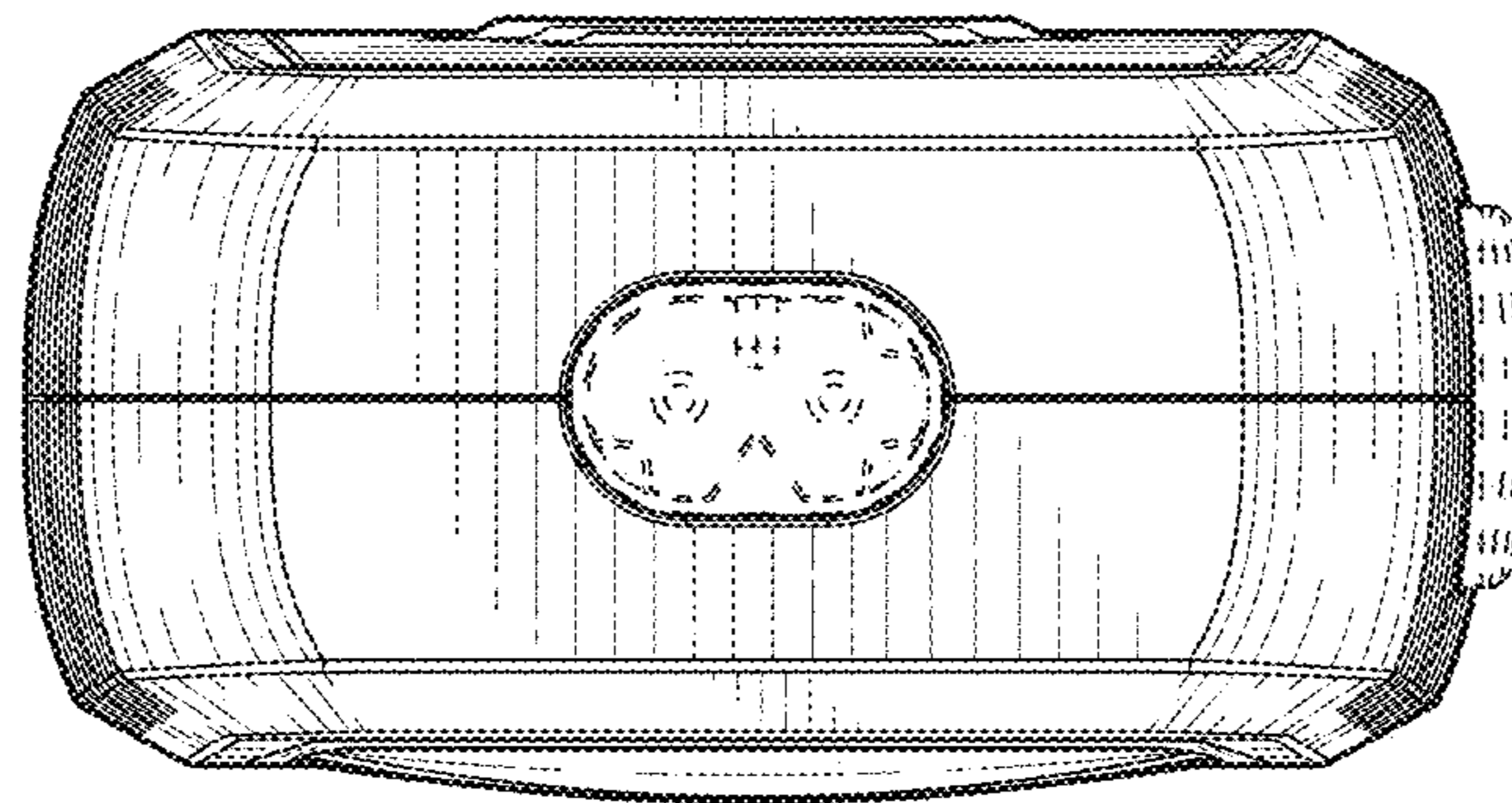

FIG. 7

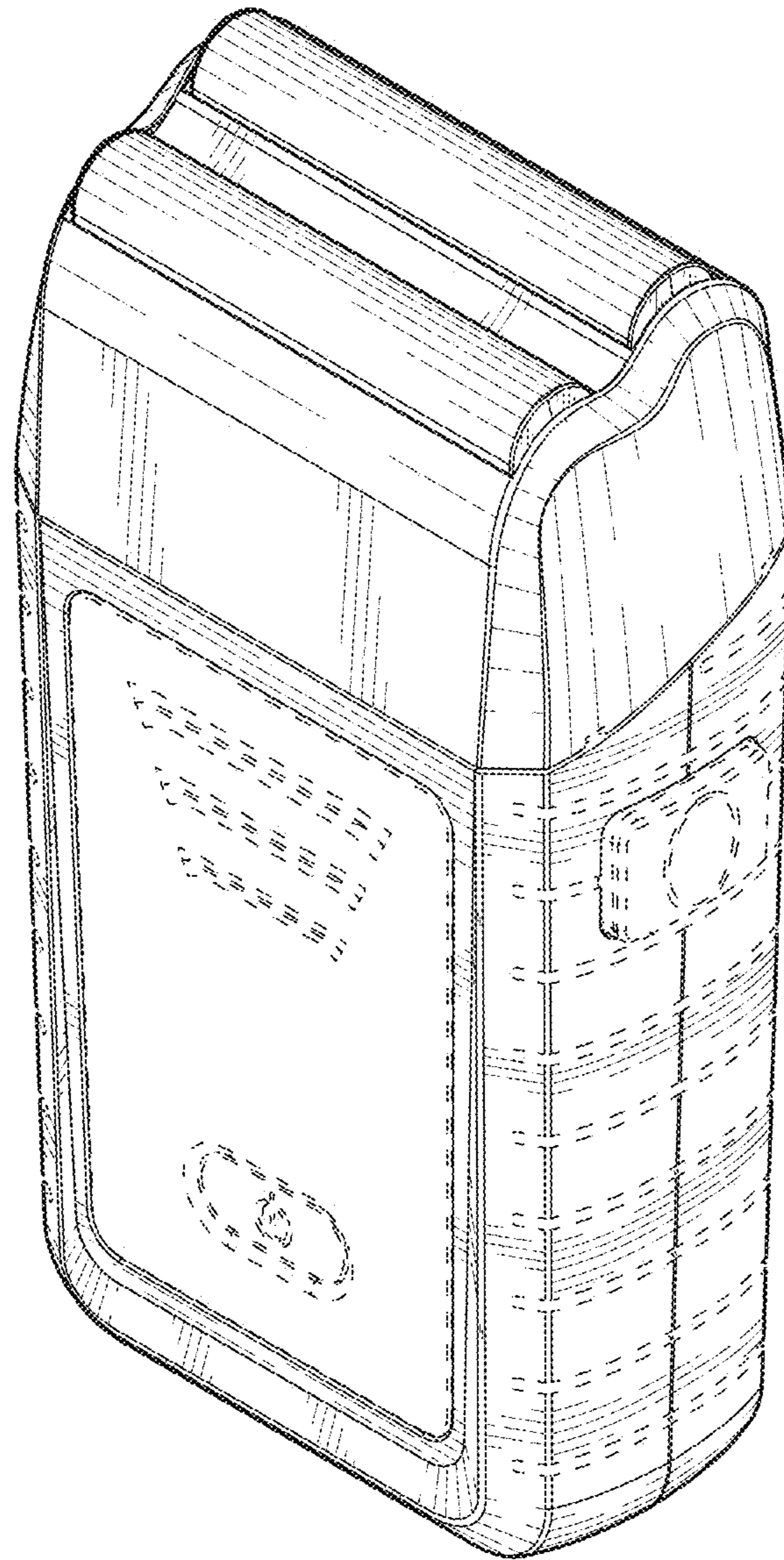

FIG. 8

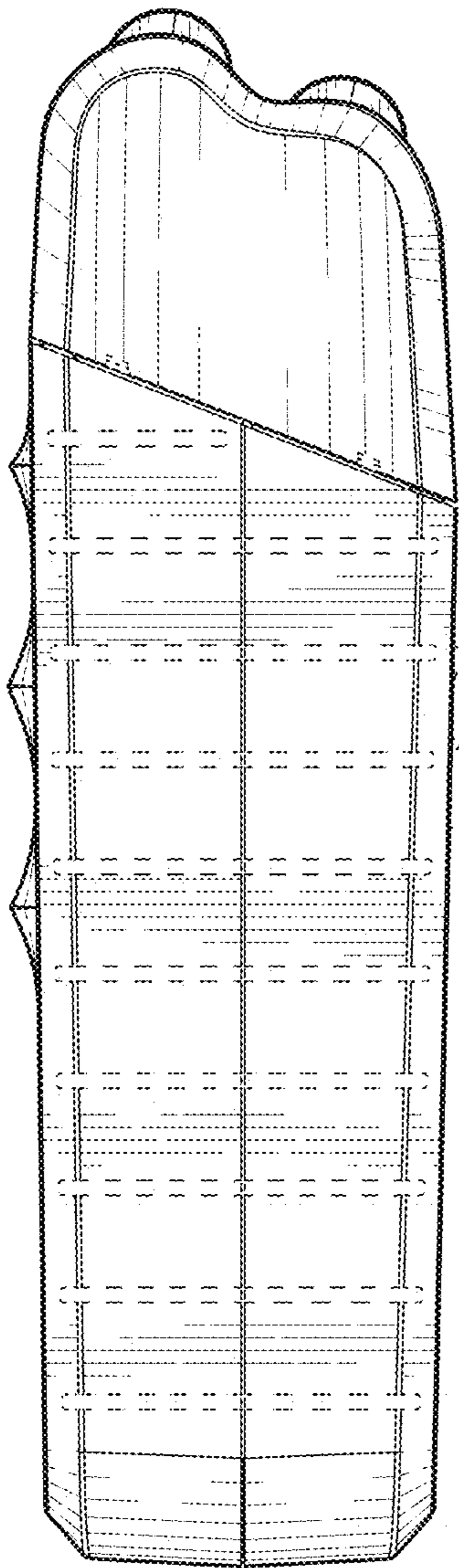

FIG. 9

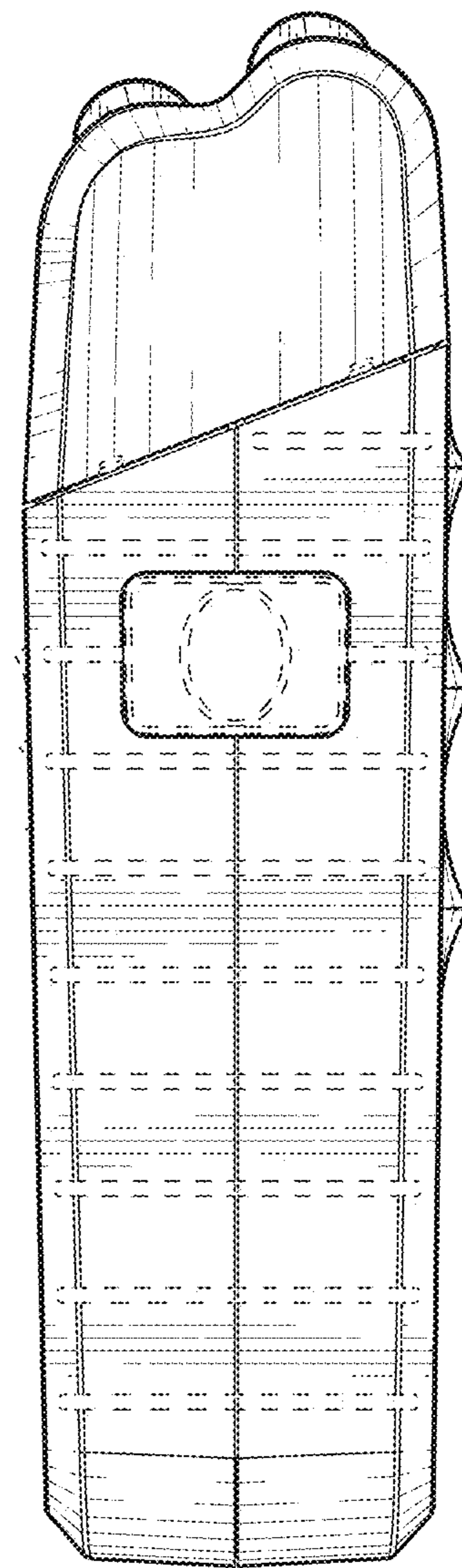

FIG. 10

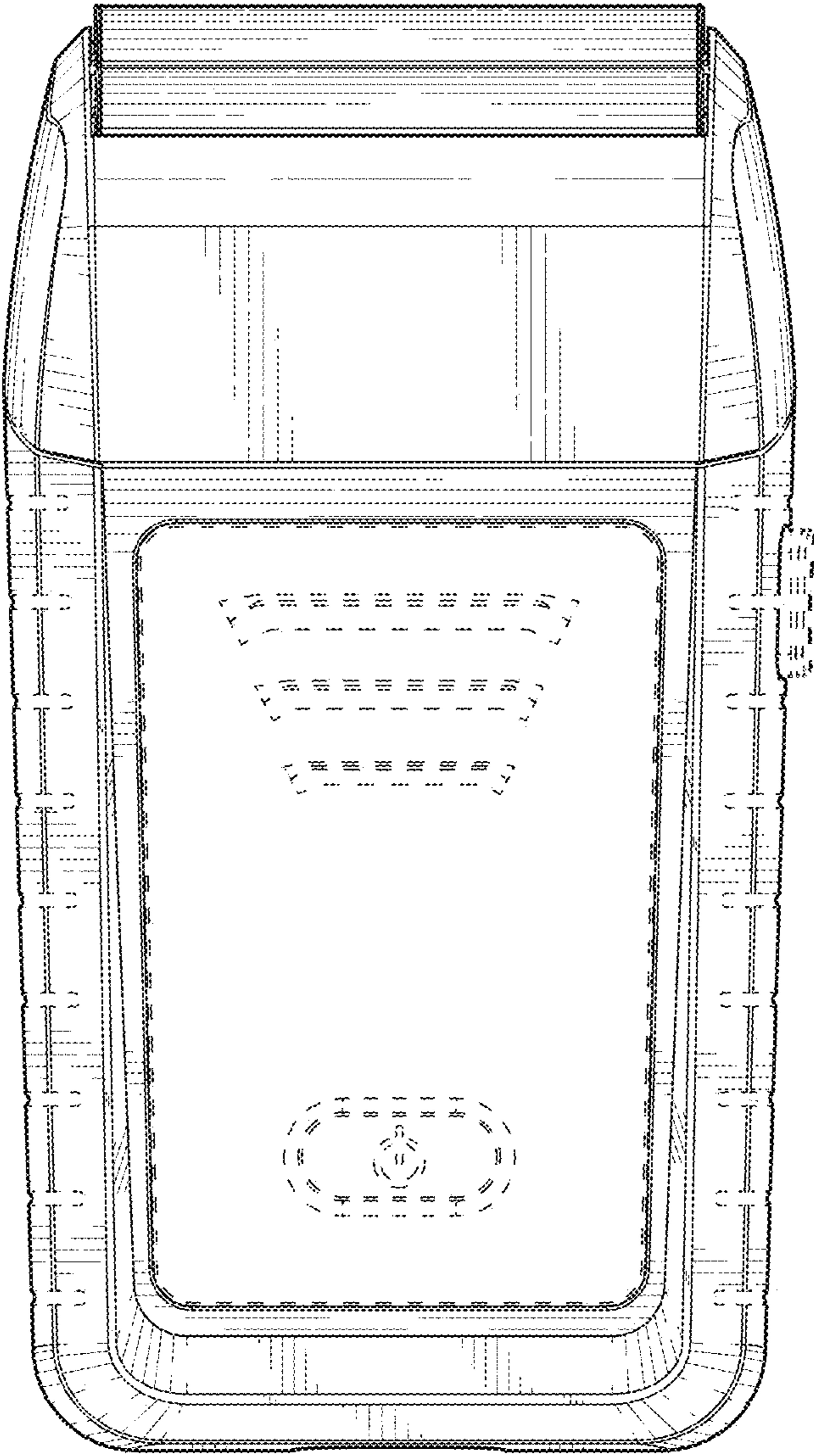

FIG. 11

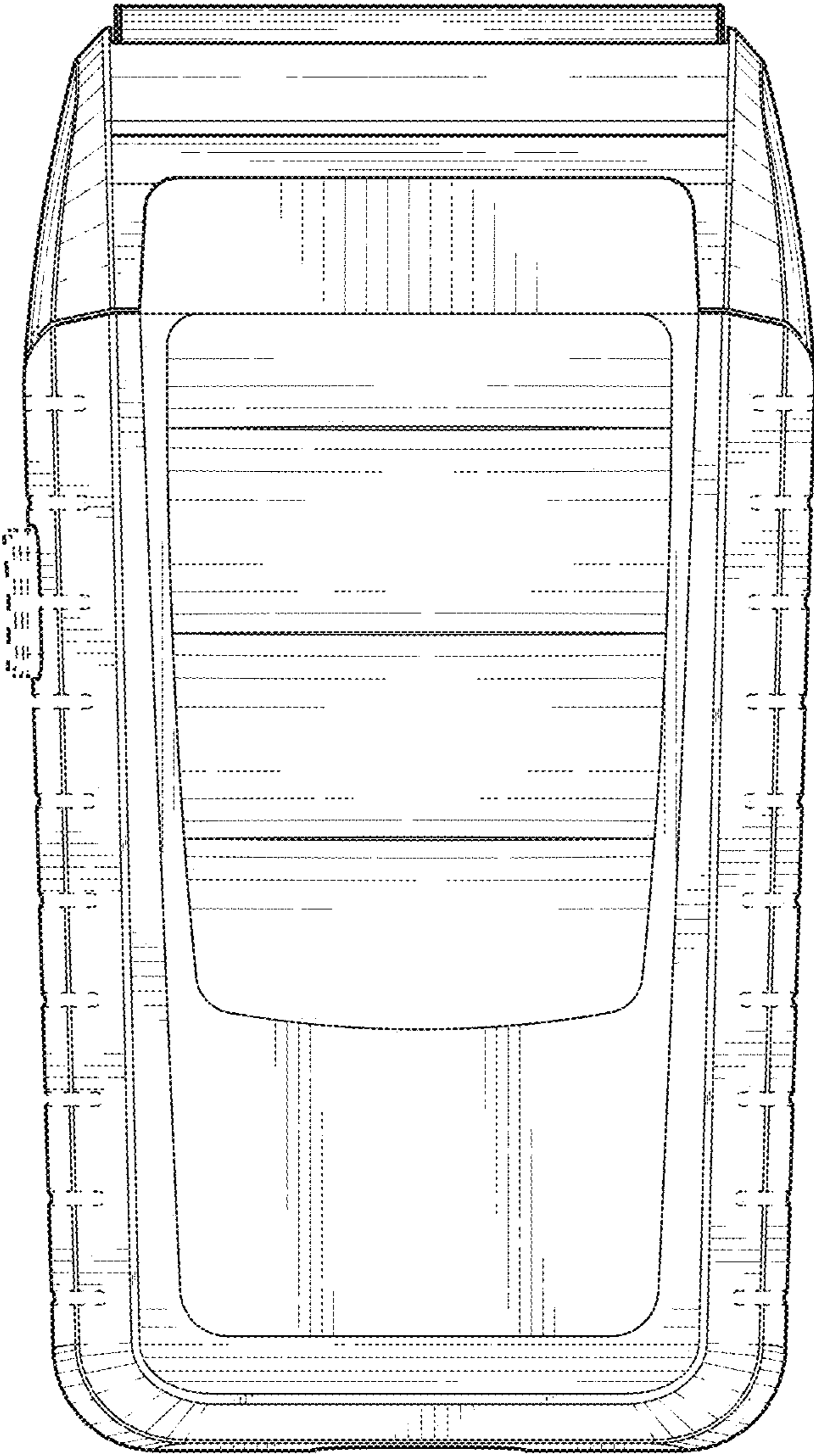

FIG. 12

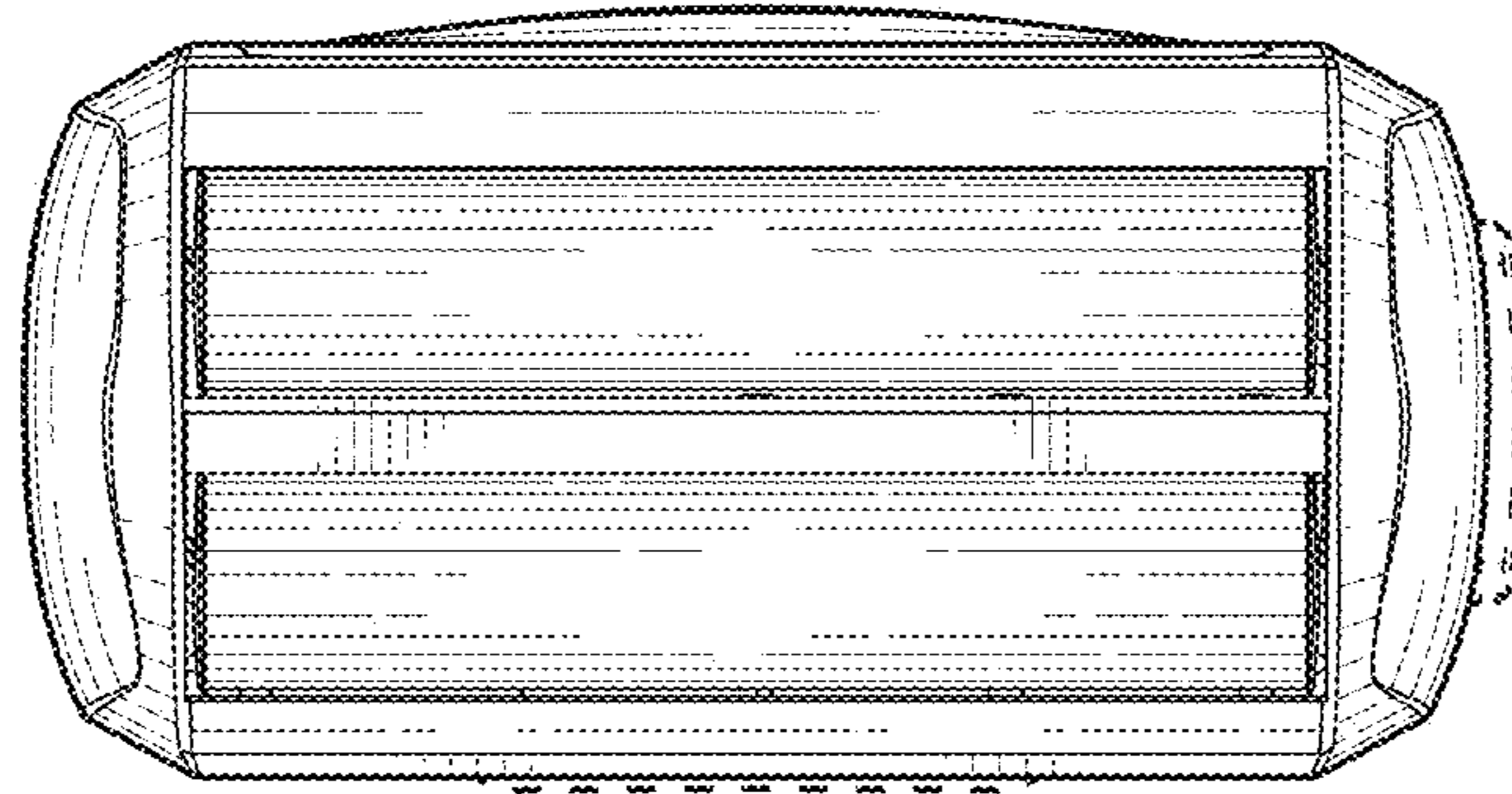

FIG. 13

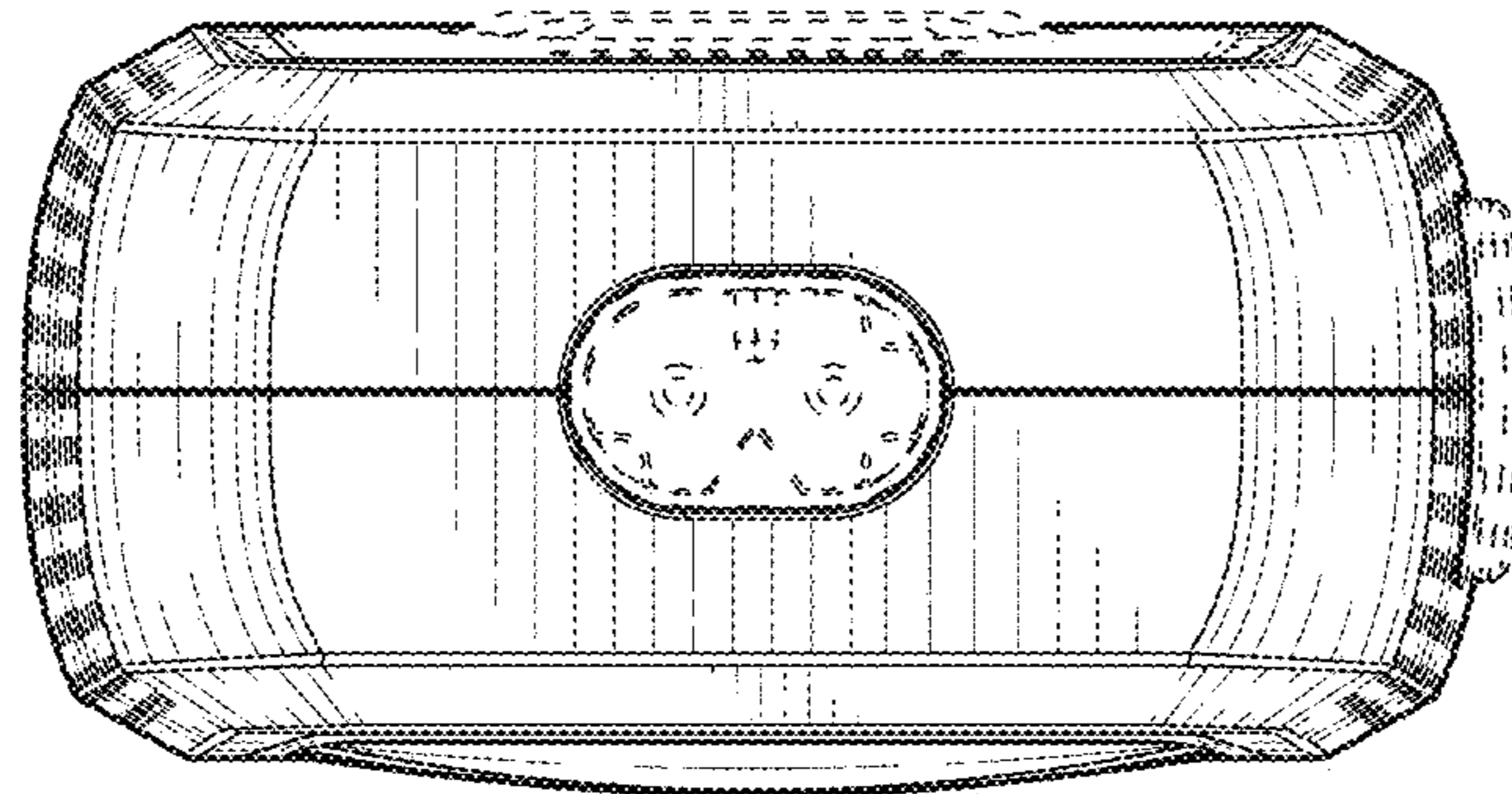

FIG. 14